



UNIVERSITY
of HAWAII®

David Lassner
President

DEPT. COMM. NO. 168

December 13, 2022

The Honorable Ronald D. Kouchi,
President and Members of the Senate
Thirty-Second State Legislature
Honolulu, Hawai'i 96813

The Honorable Scott Saiki, Speaker
and Members of the House of Representatives
Thirty-Second State Legislature
Honolulu, Hawai'i 96813

Dear President Kouchi, Speaker Saiki, and Members of the Legislature:

For your information and consideration, the University of Hawai'i is transmitting a copy of the Final Report on Recommendations on Waste Management of Clean Energy Products in Hawai'i (Act 92, Session Laws of Hawaii 2021) as requested by the Legislature.

In accordance with Section 93-16, Hawai'i Revised Statutes, this report may be viewed electronically at: <https://www.hawaii.edu/offices/government-relations/2023-legislative-reports/>.

Should you have any questions about this report, please do not hesitate to contact Stephanie Kim at 956-4250, or via e-mail at scskim@hawaii.edu.

Sincerely,

A handwritten signature in black ink that reads "David Lassner".

David Lassner
President

Enclosure

2444 Dole Street, Bachman Hall
Honolulu, Hawai'i 96822
Telephone: (808) 956-8207
Fax: (808) 956-5286

An Equal Opportunity/Affirmative Action Institution

UNIVERSITY OF HAWAI‘I SYSTEM REPORT



REPORT TO THE 2023 LEGISLATURE

Final Report on Recommendations on Waste Management of Clean
Energy Products in Hawai'i

Act 92, SLH 2021

November 2022

Hawai'i Natural Energy Institute

School of Ocean and Earth Science and Technology
University of Hawai'i at Mānoa

REPORT TO THE HAWAI'I STATE LEGISLATURE

Recommendations on Waste Management of Clean Energy Products in Hawai'i

Act 92, Session Laws of Hawai'i 2021





FOREWARD

The Hawai'i Natural Energy Institute at the University of Hawai'i at Mānoa has been tasked by Act 92, Session Laws of Hawai'i 2021 (HB1333 HD1 SD1 CD1), to report on the best practices for disposal, recycling, or secondary use of clean energy materials resulting from our transition to renewable energy. This document, in collaboration with Department of Health and Hawai'i State Energy Office, is the requested report, due 20 days prior to the convening of the first regular session of 2023.

The material contained herein is intended, primarily, to show the scope of the study and methodology used for the analysis. Clean energy materials outside this scope were not addressed but should be in future work. This work presents past, present, and future predicted material waste streams and reports on a range of options to address their management. Data from a wide variety of sources has been included but, in some cases, data on certain waste streams was approximated from indirect data or simply was not available.

The scope of this report has been limited to those elements listed in HB1333: Specifically, the amount of aging photovoltaic and solar water heater panels in the State and other types of clean energy materials expected to be discarded in the State in significant quantities, including glass, frames, wiring, inverters, and batteries. The sole exception was to include batteries from electric vehicles. The predicted waste streams for solar PV systems and components and energy storage system batteries are based upon recorded or future predictions of installed capacity in megawatts (MW_{ac}) or megawatt-hours (MWh) in Hawai'i. The predicted waste streams for EV batteries are based upon the number of EVs in Hawai'i. As this data is updated, removed, adjusted, or modified the correlated waste stream predictions can likewise be updated.

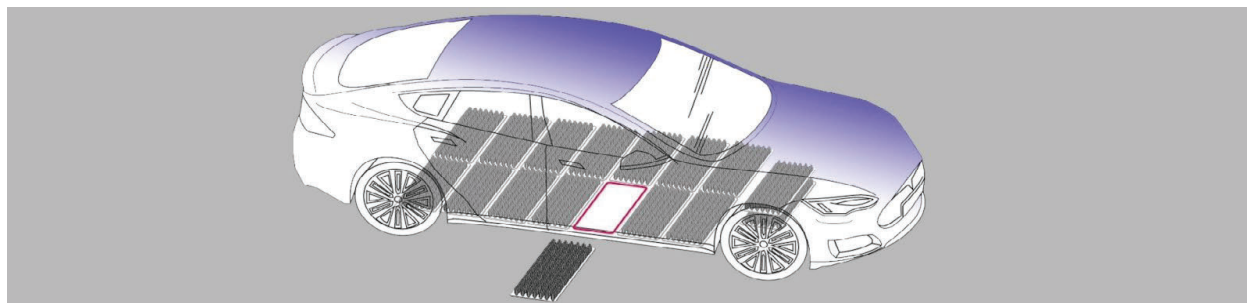

ACKNOWLEDGEMENTS

This publication was developed by the Hawai'i Natural Energy Institute in collaboration with the Hawai'i Department of Health and Hawai'i State Energy Office and with support from Hawaiian Electric Company. Michael Cooney (UHM, Hawai'i Natural Energy Institute) was the lead author and received technical assistance and or data from Monique Schafer (Hawai'i State Energy Office), Cameron Black (Hawai'i State Energy Office), Robert Isler (Hawaiian Electric Company), Richard Rocheleau (UHM, Hawai'i Natural Energy Institute), Sam Vanderhoof (RecyclePVSolar), Noa Klein (DOH, Solid and Hazardous Waste Branch), Vinh-Phong Ngo (Hawai'i Energy), John Berdner (Enphase Energy), Jie Bae (DBEDT, Research & Economic Analysis Division), and David Roth (Hawai'i Auto Dealers Association). The authors are grateful for technical editing by Dayna Lam (UHM, Hawai'i Natural Energy Institute) and Noa Klein (DOH, Solid and Hazardous Waste Branch) as well as technical input from Michael Burke (DOH, Solid and Hazardous Waste Branch), Thomas Brand (DOH, Solid and Hazardous Waste Branch), Glenn Haae (DOH, Solid and Hazardous Waste Branch), Travis Hiramoto (DOH, Solid and Hazardous Waste Branch), Jason Mitchell (Hawaiian Electric Company), Tanay Panalal (Hawaiian Electric Company), Alan Yonan (Hawaiian Electric Company), Michael Colon (Hawaiian Electric Company), Aki Marceau (Hawaiian Electric Company), Jonah Knapp (Kaua'i Island Utility Cooperative), Barry Mather (National Renewable Energy Laboratory), Mathieu Dubarry (UHM, Hawai'i Natural Energy Institute), Henry Gabriel (City and County of Honolulu's Refuse Division), Cana Ulufale (City and County of Honolulu's Refuse Division), Jed Hirota (City and County of Honolulu's Refuse Division), Ahmad Sadri (City and County of Honolulu's Refuse Division), Keola Aki (Solid Waste Division, County of Kaua'i), Tamara Farnsworth, (Environmental Protection & Sustainability Division, County of Maui Department of Environmental Management), Sanne Berrig (Recycling Coordinator, County of Hawai'i), Allison Fraley (Solid Waste Program Coordinator, County of Kaua'i, Kevin Collins (ECycling Maui), Eric Anderson (Interstate Batteries), Terry Surlles (consultant, Hawai'i Natural Energy Institute), Nick Nutter (Island Recycle), Rocky Mould (Hawai'i Solar Energy Association), Michele Mitsumori (Mr. K's Recycle), Colin Yost (RevoSun), Ryan Evans (Resource Recovery Solutions), and Noelani Evans (Resource Recovery Solutions).

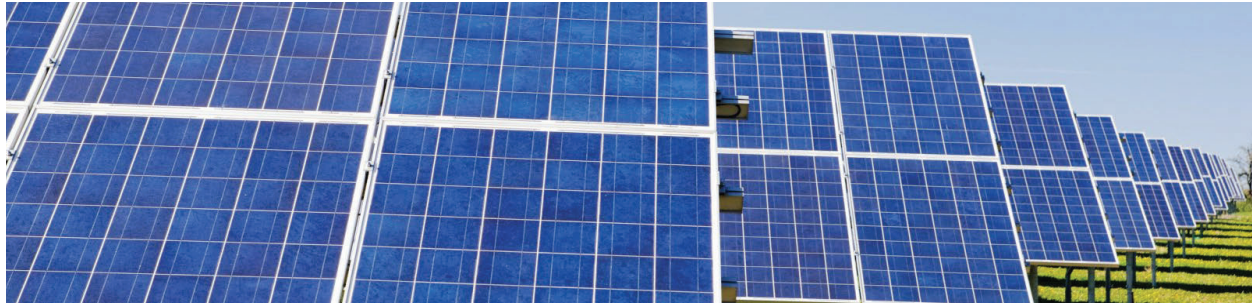

TABLE OF CONTENTS

FOREWARD	3
ACKNOWLEDGEMENTS	4
LIST OF FIGURES	8
LIST OF TABLES	10
LIST OF ABBREVIATIONS	12
EXECUTIVE SUMMARY	13
<i>Overview</i>	13
<i>Key assumptions and methodology</i>	13
<i>PV modules – composition</i>	14
<i>PV modules – numbers</i>	14
<i>PV modules – mounting structures</i>	15
<i>PV modules – cabling</i>	15
<i>PV modules – inverters</i>	16
<i>PV modules – transformers</i>	16
<i>Energy storage systems batteries – composition</i>	16
<i>Energy storage systems batteries – electric vehicles</i>	16
<i>Energy storage systems batteries – energy storage systems</i>	17
<i>Solar hot water systems</i>	17
<i>Summary and recommendations</i>	17
INTRODUCTION	19
BACKGROUND	21
Photovoltaic Systems	21
<i>PV modules</i>	21
<i>PV ancillary components</i>	24
Energy Storage Systems.....	32
<i>Batteries</i>	32
<i>Battery ancillary components</i>	36
Solar Hot Water Systems	38
<i>Solar hot water panels</i>	38
<i>Solar hot water ancillary components</i>	38

ASSESSMENT OF PENETRATION IN HAWAI'I	40
Photovoltaic Systems	40
<i>Photovoltaic penetration</i>	40
<i>Photovoltaic modules</i>	43
<i>Photovoltaic ancillary components – inverters</i>	43
<i>Photovoltaic ancillary components – transformers</i>	45
<i>Photovoltaic ancillary components – mounting structures</i>	45
<i>Photovoltaic ancillary components – cabling</i>	46
Energy Storage Systems	47
<i>Photovoltaic energy storage penetration</i>	47
<i>Electric vehicle energy storage penetration</i>	48
<i>Energy storage – batteries</i>	51
<i>Energy storage – ancillary components</i>	51
Solar Hot Water Systems	52
Future Penetration 2022 Through 2045	53
<i>Photovoltaic penetration</i>	53
<i>Photovoltaic modules</i>	55
<i>Photovoltaic energy storage penetration</i>	56
<i>Electric vehicle energy storage penetration</i>	57
QUANTITY AND TIMING OF DISPOSAL LOADING RATES.....	58
Photovoltaic Systems	58
<i>Photovoltaic modules</i>	58
<i>Photovoltaic ancillary components – mounting structures</i>	73
<i>Photovoltaic ancillary components – cabling</i>	74
<i>Photovoltaic ancillary components – inverters</i>	75
Energy Storage Systems	79
<i>Electric vehicle batteries</i>	79
<i>Grid-connected batteries</i>	80
<i>Battery ancillary components – electric vehicles</i>	81
<i>Battery ancillary components – grid-connected energy storage</i>	83
Solar Hot Water Systems	85
Summary	85
BEST PRACTICES FOR COLLECTION, DISPOSAL, AND RECYCLING OF CLEAN ENERGY MATERIALS.....	86
Hazardous or Universal Waste Classification	86
Photovoltaic Systems	87
<i>PV modules – collection</i>	89
<i>PV modules – disposal</i>	90
<i>PV modules – recycling</i>	91
<i>PV ancillary components – collection</i>	93
<i>PV ancillary components – disposal</i>	94

<i>PV ancillary components – recycling</i>	94
Energy Storage Systems	95
<i>Batteries – collection</i>	96
<i>Batteries – disposal</i>	98
<i>Battery ancillary components – collection</i>	102
<i>Battery ancillary components – disposal</i>	102
<i>Battery ancillary components – recycle</i>	103
Solar Hot Water Systems	103
<i>Solar hot water panels</i>	103
<i>Solar hot water ancillary components</i>	103
CONSIDERATIONS FOR DISPOSAL OR RECYCLING	104
Overview	104
<i>Waste generator responsibility</i>	107
<i>Expanded producer responsibility</i>	107
<i>State assisted recycle</i>	108
Lithium-ion Batteries	109
<i>Basics cost</i>	109
<i>Waste generator responsibility</i>	111
<i>Expanded producer responsibility</i>	112
<i>State assisted recycle</i>	113
Solar Hot Water Systems	114
Summary and Recommendations	114
OTHER ISSUES TO CONSIDER FOR MANAGEMENT, RECYCLING, AND DISPOSAL	117
Power Purchase Agreements	117
Extended Producer Responsibility	117
Landfill Ban	118
Handling Issues Associated with Lithium-ion Batteries	118
Household Hazardous Waste Exclusion	119
APPENDIX – TABLES	120
APPENDIX – FIGURES	154
APPENDIX – COMMUNICATIONS	160
REFERENCES	163



LIST OF FIGURES

Figure 1. Generic structure of the c-Si PV cell, module, panel, and array	22
Figure 2. Material composition of an averaged c-Si module	24
Figure 3. Topology of the microinverter, central inverter, string inverter, and multi-string inverter	26
Figure 4. Material composition of generic 500 kW string inverter	27
Figure 5. Material composition of low power inverters as a function of power rating	27
Figure 6. Mass density of inverters as a function of type and power rating	29
Figure 7. Material composition of PV solar mounting structures	31
Figure 8. Material composition of PV solar cabling	31
Figure 9. Key components of a lithium-ion battery cell.....	32
Figure 10. Averaged weight percentage of components in lithium-ion battery cells.....	34
Figure 11. Packaged Lithium-ion battery	35
Figure 12. Flat plate solar water heater panels	39
Figure 13. Ancillary components of typical solar water heater system.....	39
Figure 14. Cumulative installed PV through 2021	42
Figure 15. Cumulative PV solar installed storage through 2021	48
Figure 16. Projected electric vehicle numbers through 2045.....	50
Figure 17. Predicted cumulative penetration of residential plus commercial PV installation through 2045 as a function of island	54
Figure 18. Predicted cumulative penetration of utility-scale PV installation through 2025 as a function of island.....	54
Figure 19. Representative schematic of Hawaiian Electric utility-scale PPA.....	55
Figure 20. Predicted PV solar installed storage through 2045.....	57
Figure 21. The average value of photovoltaic modules, 2006-2020.....	59
Figure 22. Predicted disposal rates of materials from residential PV modules on O‘ahu	61
Figure 23. Predicted disposal rates of materials from residential PV modules in Hawai‘i County ...	62
Figure 24. Predicted disposal rates of materials from residential PV modules in Maui County	63
Figure 25. Predicted disposal rates of materials from residential PV modules on Kaua‘i.....	64
Figure 26. Predicted disposal rates of materials from commercial PV modules on O‘ahu	65
Figure 27. Predicted disposal rates of materials from commercial PV modules in Hawai‘i County .	66
Figure 28. Predicted disposal rates of materials from commercial PV modules in Maui County.....	67
Figure 29. Predicted disposal rates of materials from commercial PV modules on Kaua‘i	68

Figure 30. Predicted disposal rates of materials from utility PV modules on O'ahu.....	69
Figure 31. Predicted disposal rates of materials from utility PV modules in Maui County	70
Figure 32. Predicted disposal rates of materials from utility PV modules on Kaua'i.....	71
Figure 33. Predicted aggregate disposal rates of materials across all islands and scale	72
Figure 34. Aggregate disposal rates of steel from PV mounting structures across all scale for each island through 2040.....	73
Figure 35. Aggregate disposal rates of aluminum from PV mounting structures across all scale for each island	74
Figure 36. Aggregate disposal rates of copper from PV solar cabling across all scale for each island	75
Figure 37. Aggregate disposal rates of microinverters at all scale for each island	76
Figure 38. Aggregate disposal rates of string/central inverters at all scale for each island.....	76
Figure 39. Aggregate metals loading from ancillary components at all scale on the island of O'ahu.....	77
Figure 40. Aggregate metals loading from ancillary components at all scale on the island of Hawai'i	77
Figure 41. Aggregate metals loading from ancillary components at all scale in Maui County.....	78
Figure 42. Aggregate metals loading from ancillary components at all scale on the island of Kaua'i	78
Figure 43. Estimated quantity and timing of EV LIB disposal for O'ahu, Hawai'i County, Maui County, and Kaua'i	80
Figure 44. Estimated quantity and timing of grid-connected LIB disposal across all scale for O'ahu, Hawai'i County, Maui County, and Kaua'i	81
Figure 45. General process flow diagram for end-of-life management of clean energy materials	86
Figure 46. End-of-life management of photovoltaic systems	89
Figure 47. End-of-life management of battery systems	96
Figure 48. End-of-life management of battery systems	98
Figure 49. Recycle loops for recycling LIBs.....	101
Figure 50. Images of dumped PV panels and inverters.....	106
<hr/>	
Figure A1. Concentration of materials of interest in emerging electronic waste (results for year 2018) in comparison with their average concentration in ore deposits.....	154
Figure A2. Installed PV on island of Kaua'i	155
Figure A3. Installed inverters (micro, string, and battery) on island of Kaua'i	156
Figure A4. Installed energy storage on island of Kaua'i.....	157
Figure A5. Prediction of new car and truck purchases in Hawai'i	158
Figure A6. Prediction of total mass of installed clean energy materials through 2021	159



LIST OF TABLES

Table 1. Averaged composition of complete battery components for LIB chemistries.....	35
Table 2. Estimated energy densities for the five major lithium-ion chemistry	36
Table 3. Estimated parameters for dominant lithium-ion battery chemistries	36
Table 4. Composition of ancillary components of a representative lithium-ion battery for a representative hypothetical grid-scale LIB-ESS and an EV battery pack.....	37
Table 5. Estimated total PV modules installed across scale and island through 2021	43
Table 6. Estimated number of installed inverters across all islands through 2021	44
Table 7. Estimation of cumulative solar PV mounting structure materials installed through 2021 ...	46
Table 8. Estimation of cumulative solar PV cabling materials installed through 2021	47
Table 9. Estimated cumulative number of batteries per island through 2021	51
Table 10. Predicted cumulative amounts of battery ancillary components across all scales as a function of island for electric vehicles (EV Packs) and energy storage systems (Grid Storage) through 2021	52
Table 11. Total cumulative number of PV modules projected to be installed, as a function of scale and island, by 2045 and total number of new modules to be installed between 2022 and 2045.	56
Table 12. Estimated disposal loading rates of EV battery ancillary components	82
Table 13. Estimated disposal loading rates of grid-connected battery ancillary components	84
<hr/>	
Table A1. Chemical composition of c-Si PV modules	120
Table A2. Material composition of 500 kW _{ac} PV inverters	120
Table A3. Material composition of low power solar inverters	121
Table A4. Power density of inverters across scale for residential and commercial microinverters .	121
Table A5. Power density of inverters across scale for residential and commercial central/string inverters	122
Table A6. Power density of inverters across scale for large utility inverters	122
Table A7. Weight percentage of components across Li-ion battery chemistries	123
Table A8. Battery energy density as a function of chemistry and scale.....	124
Table A9. Cumulative installed PV across island and scale through 2021	125
Table A10. Cumulative number of installed Enphase microinverters through 2022 as a function of island.....	126
Table A11. Cumulative installed storage across island and scale through 2021.....	127

Table A12. Cumulative electric vehicles across islands and studies	128
Table A13. Cumulative projected PV penetration across island and scale	129
Table A14. Hawaiian Electric utility-scale renewable project status board	130
Table A15. Cumulative projected PV energy storage to be installed across island and scale.....	132
Table A16. Predicted disposal loading rates from residential PV modules on O‘ahu	133
Table A17. Predicted disposal loading rates from residential PV modules in Hawai‘i County	133
Table A18. Predicted disposal loading rates from residential PV modules on Maui.....	134
Table A19. Predicted disposal loading rates from residential PV modules on Kaua‘i	134
Table A20. Predicted disposal loading rates from commercial PV modules on O‘ahu.....	135
Table A21. Predicted disposal loading rates from commercial PV modules in Hawai‘i County.....	135
Table A22. Predicted disposal loading rates from commercial PV modules on Maui	136
Table A23. Predicted disposal loading rates from commercial PV modules on Kaua‘i.....	136
Table A24. Predicted disposal loading rates from utility PV modules on O‘ahu	137
Table A25. Predicted disposal loading rates from utility PV modules in Hawai‘i County	137
Table A26. Predicted disposal loading rates from utility PV modules on Maui.....	138
Table A27. Predicted disposal loading rates from utility PV modules on Kaua‘i	138
Table A28. Aggregate prediction of PV material disposal rates across all islands and scale.....	139
Table A29. Aggregate prediction of PV material disposal rates on O‘ahu across all scale.....	139
Table A30. Aggregate prediction of PV material disposal rates in Hawai‘i County across all scale	140
Table A31. Aggregate prediction of PV material disposal rates on Maui across all scale	140
Table A32. Aggregate prediction of PV material disposal rates on Kaua‘i across all scale.....	141
Table A33. Predicted disposal rates from PV mounting structure across all scale on each island...	142
Table A34. Predicted disposal rates from residential PV mounting structures on each island.....	143
Table A35. Predicted disposal loading rates from commercial PV mounting structures	144
Table A36. Predicted disposal loading rates from utility PV mounting structures	145
Table A37. Predicted disposal rates from PV cabling across all scale for each island.....	146
Table A38. Predicted disposal rates from residential PV cabling on each island	147
Table A39. Predicted disposal rates from commercial PV cabling on each island.....	148
Table A40. Predicted disposal rates from utility PV cabling on each island	149
Table A41. Predicted disposal rates from PV inverters across all scale on each island	150
Table A41 (cont.). Predicted disposal rates from PV inverters across all scale on each island.....	151
Table A42. Aggregate metals disposal rates from ancillary components across all scale for each island.....	152
Table A43. Estimated number of EV batteries disposed on each island	152
Table A44. Estimated number of energy storage batteries disposed on each island.....	153



LIST OF ABBREVIATIONS

AC	Alternating Current	HMR	Hazardous Materials Regulations
a-Si	Amorphous Silicon	HNEI	Hawai'i Natural Energy Institute
BESS	Battery Energy Storage System	HSEO	Hawai'i State Energy Office
BMS	Battery Management System	IPP	Independent Power Producer
BOS	Balance of System	ISRF	Inverter sizing ratio factor
c-Si	Crystalline Silicon	LCO	Lithium cobalt oxide battery
CIG	Copper Indium Gallium Alloys	LMO	Lithium manganese oxide
CIGS	Copper Indium Gallium Selenide	LFP	Lithium Iron Phosphate battery
CdTe	Cadmium Telluride	LIB	Lithium-ion Battery
DC	Direct Current	LiAsF₆	Lithium hexafluoroarsenate
DEC	Ethyl Methyl Carbonate	LiClO₄	Lithium perchlorate
DOH	Department of Health	LiPF₆	Lithium hexafluorophosphate
DMC	Dimethyl Carbonate	NCA	Lithium Nickel Cobalt Aluminum Oxide Battery
EC	Ethylene-carbonate	Ni-Cd	Nickel-Cadmium Battery
EoL	End of Life	NiMH	Nickel-Metal Hydride Battery
EMS	Environmental Management System	NMC	Lithium Manganese Cobalt Oxide battery
EPR	Extended Producer Responsibility	NREL	National Renewable Energy Laboratory
ESS	Energy Storage System	Pb-AC	Lead Acetate Battery
EV	Electric Vehicles	PC	Propylene-Carbonate
EVA	Ethylene Vinyl Acetate	PPA	Power Purchase Agreement
GaAs	Gallium Arsenide	PV	Photovoltaic
HADA	Hawai'i Auto Dealers Association	SAR	State Assisted Recycle
HAR	Hawai'i Administrative Rules	WEEE	Waste Electrical and Electronic Equipment
HECO	Hawaiian Electric Company	WGR	Waste Generator Responsibility



EXECUTIVE SUMMARY

Overview. As recognized by the Hawai'i State Legislature and Governor David Y. Ige, an increasing quantity of clean energy product materials are being used in Hawai'i in support of the state's goals and this is anticipated to result in the need to manage and dispose of these materials at the end of their useful lives.

Solar photovoltaic (PV) systems are comprised of PV modules, mounting structures, cabling, and inverters. PV systems are increasingly paired with lithium-ion batteries. Large utility-scale installations also include transformers. PV modules are composed of both recyclable materials and trace amounts of precious and toxic metals. Their underlying amounts (per MW) and composition will vary considerably with technology (i.e., c-Si versus thin film). The vast majority of PV modules installed in Hawai'i are crystalline silicon, although thin film technologies are projected to increase market share. Mounting structures and cabling are comprised of common recyclable metals although their underlying amounts will vary with installation design and scale. Inverters are electronic circuit boards encased within recyclable metal or plastic enclosures. The underlying amounts and composition of these materials will also vary with design and scale.

Batteries are devices that store chemical energy. Variations in materials and construction have produced different types of batteries but the vast majority employed in PV energy storage or electric vehicle systems employ lithium-ion chemistry.

Solar hot water systems use thermal energy from the sun to heat water and do not generate actual electricity.

Key assumptions and methodology. This study makes a series of assumptions to accommodate the lack of granular data available for each projected clean energy product. To determine the anticipated waste streams of various clean energy components, a lifespan of each major component assumed as listed below:

- PV panels and PV ancillary components (residential, commercial, utility): 20-year lifespan
- Batteries (electric vehicle, residential PV, commercial PV, utility PV): 10-year lifespan

To calculate weight for PV components, the total capacity installed expressed in megawatts (MW) AC was used as the proxy to estimate the total number of PV modules installed by year:

- Direct current (DC) to alternating current (AC) ratio was 1.4.
- Average residential module power rating was 250 watts direct current (W_{dc}).
- Average commercial/utility module power rating was 350 watts direct current (W_{dc}).

Similarly, the storage capacity expressed in megawatt hours (MWh) was used to estimate the number of batteries (residential, commercial and utility) on each island. These calculations assumed 14 kWh per battery at residential-scale, 100 kWh per battery at commercial-scale, and 4 MWh per battery at utility-scale. EV battery numbers were obtained based on the number of EVs.

The material composition of battery components was estimated using various data sources from differing manufacturers. Given the variability between products, and assumptions made to estimate the material components by weight, the values in this study should be taken for estimate purposes only.

PV modules – composition. The major materials in PV (c-Si) modules are glass (~68%), aluminum (~15%, mostly frame), encapsulant polymers (~7%), high grade silicon (~3%), copper (0.6%) and an assortment of additional metals (~1.0% in aggregate) including, aluminum, zinc, lead, tin, silver (soldering) and magnesium. While new technologies are emerging, which will alter the relative percent ratios of materials such as glass and aluminum framing as well as the total weight per PV module (e.g., thin-film), these new models have yet to penetrate Hawai'i in any measurable fashion and when they do will not penetrate waste streams until after 2045. The complexity of high energy and chemical recycling methods coupled with a lack of substantial cash value of the recovered materials, along with the cost of shipping is keeping PV module recycling a cost-plus activity.

PV modules – numbers. The cumulative installed PV through 2021 is estimated to be just under 1,200 MW across all islands and scale: 536.4 MW for residential, 378.3 MW for commercial, and 284.5 MW for utility. Based on these numbers, as of 2021 it is estimated that a total of 5.66 million panels have been installed in the State of Hawai'i: 3.86 million PV modules have been installed on O'ahu, 720,000 in Maui County, 580,000 in Hawai'i County, and approximately 480,000 on Kaua'i. Although modules are already starting to enter the waste streams (most notably in Hawai'i County), assuming a 20-year lifespan our data on *installed* capacity suggests that measurable numbers of PV modules will begin to enter the waste streams in starting in 2027, thereafter increasing rapidly to a maximum of 833,000 disposed of per year across all islands and scale in 2039. Waste stream estimates based on installed capacity decrease to around 321,000 per year by

2040. Most modules to be disposed of are on O'ahu and the yearly disposal rate can significantly vary year by year when including utility-scale PV modules¹.

Moreover, after 2021, an additional 6.37 million panels are expected to be installed in Hawai'i across all scales: 3.83 million on O'ahu, 807,000 in Maui County, 1.34 million in Hawai'i County, and 393,000 on Kaua'i by 2045. The predictions for future penetration are only rough estimates based upon several assumptions that should be revisited in the future.

PV modules – mounting structures. PV module mounting structures are primarily composed of steel or aluminum with trace amounts of plastic or rubber. PV module cabling is largely copper metal with thermoplastic insulation. Aluminum wiring can also be significant at utility-scale. The material composition of these components will generally remain constant although amounts (per MW) will vary with scale, system design, and year². These materials are recycled through established income-earning pathways. Significant variations can occur between steel and aluminum at the utility-scale due to variations in the mounting structure design.

As of 2021, it is estimated that across all scales there is approximately 35.1 million kg of steel and aluminum installed in mounting structures on O'ahu, 4.12 million kg in Maui County, 2.83 million kg in Hawai'i County, and 8.87 million on Kaua'i. The higher amount on Kaua'i (relative to Maui or Hawai'i County) results from a step increase in utility-scale installations on Kaua'i between 2015 and 2019. From this, disposal rates of approximately 1 million kg of steel and 1.5 million kg of aluminum are projected on O'ahu through 2040, with a one-time surge to 7 million kg of steel and 4.5 million kg of aluminum in 2039. Maui is projected to encounter relatively steady disposal rates of just over 100,000 kg of steel and steady growth to around 300,000 kg of aluminum in 2038. Hawai'i County is projected to see disposal rates steadily rise from zero to around 120,000 kg of steel and 300,000 kg of aluminum in 2035, thereafter decreasing to around 50,000 kg of steel and 100,000 kg of aluminum in 2040. Predicted disposal rates for Kaua'i are highly intermittent, jumping from values as low as 51,000 kg to as high as 1,000,000 kg in any given year owing to the high relative contribution from utility-scale projects.

PV modules – cabling. As of 2021, it is estimated that there is 2.03 million kg of copper and 69,000 kg of aluminum contained in cabling across all islands and scales. Projected yearly disposal rates can vary considerably, with values on O'ahu as high as 400,000 and 900,000 kg in the years 2037 and 2039, respectively. Disposal rates are considerably lower in Hawai'i and Maui County, with values of approximately 40,000 kg of copper per year in 2037 and 2039, respectively. Disposal rates for Kaua'i are quite variable, with values near zero through 2029 and upwards of

¹ Utility-scale installations can vary substantially from year to year depending on solicitations and procurements for new solar PV energy projects.

² Predominately due to the variability that can occur in the design of utility-scale installations.

85,000 kg copper in 2034 and 140,000 in 2038. These materials can be recycled through established pathways.

PV modules – inverters. Inverters contain plastics or major metals (copper, steel, or aluminum) along with an assortment of metals at trace concentrations (i.e., nickel (Ni), gold (Au), tin (Sn), lead (Pb), iron (Fe), zinc (Zn), magnesium (Mg), and manganese (Mn)). The underlying amount and relative composition of these materials will vary with size, voltage rating, phase, manufacturer, model, and year manufactured. The enclosure materials are recycled through traditional income-earning pathways while the metals in the circuit boards are processed as electronic waste. These materials can be processed through established pathways for e-waste although they may incur a cost when factoring in the cost of ocean transport.

As of 2021, it is estimated that there are, across all islands, approximately 1.48 million residential microinverters, 64,000 residential scale string inverters, 17,000 commercial string inverters, and 110 utility-scale inverters. Long term, the disposal rate of microinverters is expected to sharply increase from close to zero in 2022 to a maximum of approximately 180,000 on O'ahu in 2033, 31,000 in Maui County in 2036, 30,000 in Hawai'i County in 2035, and 6,500 on Kaua'i in 2034. Thereafter, rates steadily decrease to around 60,000 per year on O'ahu, 16,000 in Maui County, 11,000 in Hawai'i County, and 8,060 on Kaua'i by 2035. The disposal rates (per year) of string inverters (all scale) are projected to rise significantly to a peak of 1,570 in Maui County by 2035, 4,940 on O'ahu by 2036, 1,510 in Hawai'i County by 2035, and 413 on Kaua'i by 2035.

PV modules – transformers. The estimated number of transformers installed on O'ahu, in Hawai'i County, in Maui County, and on Kaua'i are 198, 0, 7, and 80, respectively.

Energy storage systems batteries – composition. The major materials of lithium-ion batteries are trace amounts of metals and minerals (chromium [Cr], nickel [Ni], cobalt [Co], manganese [Mn], and copper [Cu]), recyclable metals (steel), graphite carbon, plastics, and electrolyte (lithium hexafluorophosphate [LiPF₆] and organic solvents). Lithium-ion batteries are flammable and require strict storage and shipping conditions. The complexity and variability in electrode chemistry is currently presenting challenges to the establishment of common and generic recycle pathways. The flammability of the electrolyte also makes them difficult and expensive to collect, store, and transport to mainland recycling operations. As such, the need for tipping fees to pay for the recycling process will remain significant.

Energy storage systems batteries – electric vehicles. As of 2021, the State of Hawai'i (excluding Kaua'i) had approximately 15,628 EV batteries: 11,345 on O'ahu, 1,018 in Hawai'i County, and 3,265 in Maui County. As of 2021, only 530 electric vehicles were registered on Kaua'i. The disposal rates (per year) for EV batteries are predicted to steadily increase from a total estimate of

650 batteries per year across all islands in 2022³ to approximately 6,914 on O'ahu, 2,048 in Hawai'i County, 5,386 in Maui County, and around 60 on Kaua'i by 2039.

Energy storage systems batteries – energy storage systems. As of 2021, the total number of energy storage batteries (residential and commercial scale) is estimated to be 8,533 on O'ahu, 4,132 in Hawai'i County, 2,462 in Maui County, and 494 on Kaua'i. The number of utility-scale batteries is estimated at 7 in Maui County and 39 on Kaua'i. The disposal rate of energy storage LIBs on O'ahu is projected to rise from 46 in 2022 to a peak of just under 4,650 in 2033 assuming a 10-year lifespan. The same trends occur on the other islands but at lower numbers. The island of Hawai'i, for example, is projected to start at 15 in 2022 and increase to around 1,687 in 2031. Maui is projected to start with 10 batteries in 2021 and rise to as high as 1,387 in 2030. Kaua'i is projected to go from zero in 2022 to as high as 805 in 2031.

Solar hot water systems. Quantitative data on solar hot water system is not tracked by any central source and is therefore not available. That said, the State of Hawai'i has one of the most successful solar water heating programs in the country. Although not dominant, the market penetration of solar water heaters in Hawai'i is impressive. To date, about one in four single-family homes in Hawai'i use solar water heaters, with some estimates suggesting 90,000 residential solar water heating systems are in operation in the Hawaiian Electric service territories of O'ahu, Maui County, and Hawai'i County [1]. Waste streams from solar hot water systems are not classified as hazardous and all streams are and have been processed in the State along with other appliances.

Summary and recommendations. A total of 225,000 tons of PV related clean energy materials have been installed in Hawai'i through 2021⁴. For context, the total amount of municipal solid waste and commercial/demolition waste generated in the State during 2021 was 2,570,478 tons [2]. This suggests that the total amount of these PV related clean energy materials installed to date total 8.8% of all municipal solid waste and commercial/demolition waste generated across the entire State in 2021. The major contributors (both PV panel and lithium ion batteries) require collection, disposal, and recycle steps designed for hazardous materials. Going forward, these new and emerging waste streams will begin to accelerate during the latter half of this decade. While the overall amount of these PV related clean energy materials appears relatively low, it was determined that some of those responsible for the management, collection, disposal, and recycling of these new and emerging waste streams currently lack adequate capacity and preparation to process them. For these and other reasons that will be expanded upon in this report, it is therefore recommended that going forward some combination of the following three thrusts be pursued:

1. Ensure and enforce waste generator responsibility;

³ Approximately 460 on O'ahu, 40 in Hawai'i County, 92 in Maui Country, and 60 on Kaua'i.

⁴ This includes PV cabling, mounting structures, inverters, and panels (across all islands and scale), electric vehicle batteries, and energy storage batteries.

2. Pursue and manage Extended Producer Responsibility (EPR) where possible; and
3. Implement an Advanced Disposal Fee program.

In addition, the following actions are recommended:

1. Continue the work of tracking the penetration and composition of clean energy materials and to update, as appropriate, the predicted disposal loading rates;
2. Develop an environmental waste management strategy for these clean energy waste streams;
3. Organize the education and training of contractors, salvagers, and relevant staff in the counties as to best practices and laws governing the collection, storage, and transport of these clean energy waste streams;
4. Organize public service announcements educating residential, commercial, and utility-scale owners of their waste generator responsibilities;
5. Review PPAs with respect to end of life disposal responsibilities as well as mechanisms for enforcement in cases of IPP default;
6. Assist recyclers, as appropriate, with the expansion of their businesses to increase their capacities, including those based in Hawai'i and potential business partners in the U.S.;
7. Identify and track EPR opportunities;
8. Identify and track mainland recyclers,
9. Identify funding for the disposal and recycling of clean energy materials;
10. Consider state-wide agreements with off-island recyclers that support long-term and cost-effective access; and
11. Consider waste streams from additional renewable sources, such as tidal, geothermal, wind, and cadmium-telluride (CdTe) PV. Each of these technologies possess issues that have been raised by community members and are worth further study.

INTRODUCTION

The 2021 Hawai'i State Legislature passed and the Governor enacted Act 92, Session Laws of Hawai'i 2021 (HB1333, House Draft 1, Senate Draft 1, Conference Draft 1), relating to energy. This law required “the Hawai'i Natural Energy Institute (HNEI), in consultation with the Department of Health (DOH), to conduct a comprehensive study to determine best practices for disposal, recycling, or secondary use of clean energy products in the State.”

Specifically, the law required HNEI to address and evaluate the following six topics:

1. The amount of aging photovoltaic and solar water heater panels in the State that will need to be disposed of or recycled;
2. Other types of clean energy materials are expected to be discarded in the State in substantial and growing quantities, including glass, frames, wiring, inverters, and batteries;
3. The type and chemical composition of those clean energy materials;
4. Best practices for the collection, disposal, recycling, or reuse of those clean energy materials;
5. Whether a fee should be charged for disposal or recycling of those clean energy materials; and
6. Any other issues that the Hawai'i Natural Energy Institute and Department of Health consider appropriate for management, recycling, and disposal of those clean energy materials.

Per the legislation's requirement, this final report has been organized into six sections that provide, to the extent possible, the information requested in the six topics. This information is not meant to be exhaustive, but rather serves as a capable review of the topics requested under Act 92. How each section of this report addresses the specific request of each topic is described below.

- Section 1 (**BACKGROUND**) provides background information related to the three types of clean energy systems under evaluation: solar photovoltaics, energy storage, and solar hot water. Section 1 also restricts the focus of this evaluation to those specific technologies, within these three categories, already deployed in Hawai'i. The chemical composition of these clean energy materials is also assessed, on a standardized basis (per kW_p of PV module or per kWh of storage, for example), for use in the following sections. These chemical descriptions address not only the primary components (i.e., photovoltaic modules, energy storage batteries, and solar hot water panels) of these systems, but also their key ancillary components (i.e., glass, frames, wiring, inverters).
- Section 2 (**ASSESSMENT OF PENETRATION IN HAWAI'I**) quantifies the current penetration of aging solar photovoltaic (PV), energy storage (PV and electric vehicle), and solar hot water systems, as well as a limited estimate of their future potential deployment

through the year 2045. A variety of state agency and utility resources have been used to produce these estimates.

- Section 3 (**QUANTITY AND TIMING OF DISPOSAL LOADING RATES**) uses the information from Sections 1 and 2, along with estimates of projected lifetimes of the various components, to predict the quantity and timing of their disposal in future years.
- Section 4 (**BEST PRACTICES FOR COLLECTION, DISPOSAL, AND RECYCLING OF CLEAN ENERGY MATERIALS**) provides an overview of best practices for the collection, disposal, and recycling of modules, batteries, and ancillary components from clean energy systems. This section also provides a brief overview on the state-of-the-art recycling technologies for each system.
- Section 5 (**CONSIDERATIONS FOR DISPOSAL OR RECYCLING**) provides an evaluation of the costs associated with the collection, disposal, and recycling of clean energy materials, as well as a discussion on how these costs should be covered.
- Section 6 (**OTHER ISSUES TO CONSIDER FOR MANAGEMENT, RECYCLING, AND DISPOSAL**) identifies additional issues related to the management, recycling, and disposal of clean energy systems that may be pertinent to the Act 92 request.

BACKGROUND

The following section provides background information related to the three types of clean energy systems under evaluation: solar photovoltaics systems, energy storage systems, and solar hot water systems. This information is not meant to be exhaustive, but to provide a general overview of these systems and their characteristics. This section also describes the type and chemical composition of these clean energy systems on a standardized basis of the weight of material per amount of installed PV capacity (kg/kW).

Photovoltaic Systems

Solar photovoltaic (PV) modules and associated ancillary components are predicted to become a higher source of solid waste (kg) per unit energy (kW) than any other source of electric energy generation [3]. This section provides a review of photovoltaic systems of interest for Hawai'i and a brief description of those ancillary components found in the typical installation.

PV modules. Photovoltaic (PV) modules are commonly classified according to the structure of the active light absorbing semiconductor cell used for power generation [4]. Moreover, they are further referred to as first, second, or third generation cells [5, 6]. First generation PV solar cells are made of high-purity crystalline silicon wafers typically 160–190 μm in thickness [7, 8]. The most common materials to make crystalline silicon modules are silicon, copper, silver, and lead [9]. With proven stability and reliability, PV modules made from crystalline silicon solar cells (c-Si) have dominated the rooftop market and represent a large share of utility-scale systems [10]. Second generation solar materials comprise thin films of one or more layers of photovoltaic semiconductor materials deposited onto a low-cost backing, e.g., glass, plastic, or stainless steel [11]. The most common materials used to produce the thin film PV cells include amorphous silicon (a-Si), cadmium telluride (CdTe), or various copper indium gallium alloys (CIG) [12]. Third generation solar cells use less commercially advanced technologies such as dye-sensitized, organic, and hybrid solar cells [13]. While thin-film materials have seen some degree of commercial success, the vast majority of modules worldwide (> 95% in 2014, >90% in 2020⁵) are fabricated using crystalline (single or poly) silicon [12, 14-17]. To our knowledge, there has been no substantial deployment of any of the other module types in Hawai'i to date.

The general structure of the crystalline (c-Si) PV module includes (i) an aluminum (anodized or powder coated) frame, (ii) a transparent tempered glass or polymeric pane, (iii) an ethylene vinyl acetate (EVA) film that encapsulates the semi-conductor electrodes, (iv) metal electrodes affixed to the solar cells for current collection, (v) a plastic back sheet to protect from the environment, and (vi) a junction box that electrically connects the output of the PV module to the string (Figure 1A) [18, 19]. The solar cell rests below the shock resistant glass and under the protective layer of

⁵ See, for example, <https://www.energy.gov/eere/solar/solar-photovoltaic-cell-basics>. Last accessed on 8/8/2022.

the Ethylene Vinyl Acetate (EVA) film, which acts as an encapsulant of the solar cells (Figure 1A and 1B). A back-sheet, typically made of polyvinyl fluoride (PVF) or a combination of PVF with polyethylene terephthalate (PTE), serves as the backend of the module (Figure 1B). Once assembled, these components are heated under vacuum to melt the EVA and fill the space between the front glass of the module and the rear polyvinyl fluoride lamination sheet (i.e., to create a sealant). A junction box is then added at the rear of the module to service output connections (Figure 1B) [20]. The final framing of the whole module is performed after an additional sealant has been added to secure the aluminum frame (Figure 1B) [21]. As shown in Figure 1C, the cells are further combined to form PV module (i.e., multiple cells fabricated together in a unit). The PV modules are then aggregated to form panels or arrays (Figure 1C). Recycling and/or waste management technologies address all elements of the module.

Figure 1. Generic structure of the c-Si PV cell, module, panel, and array.

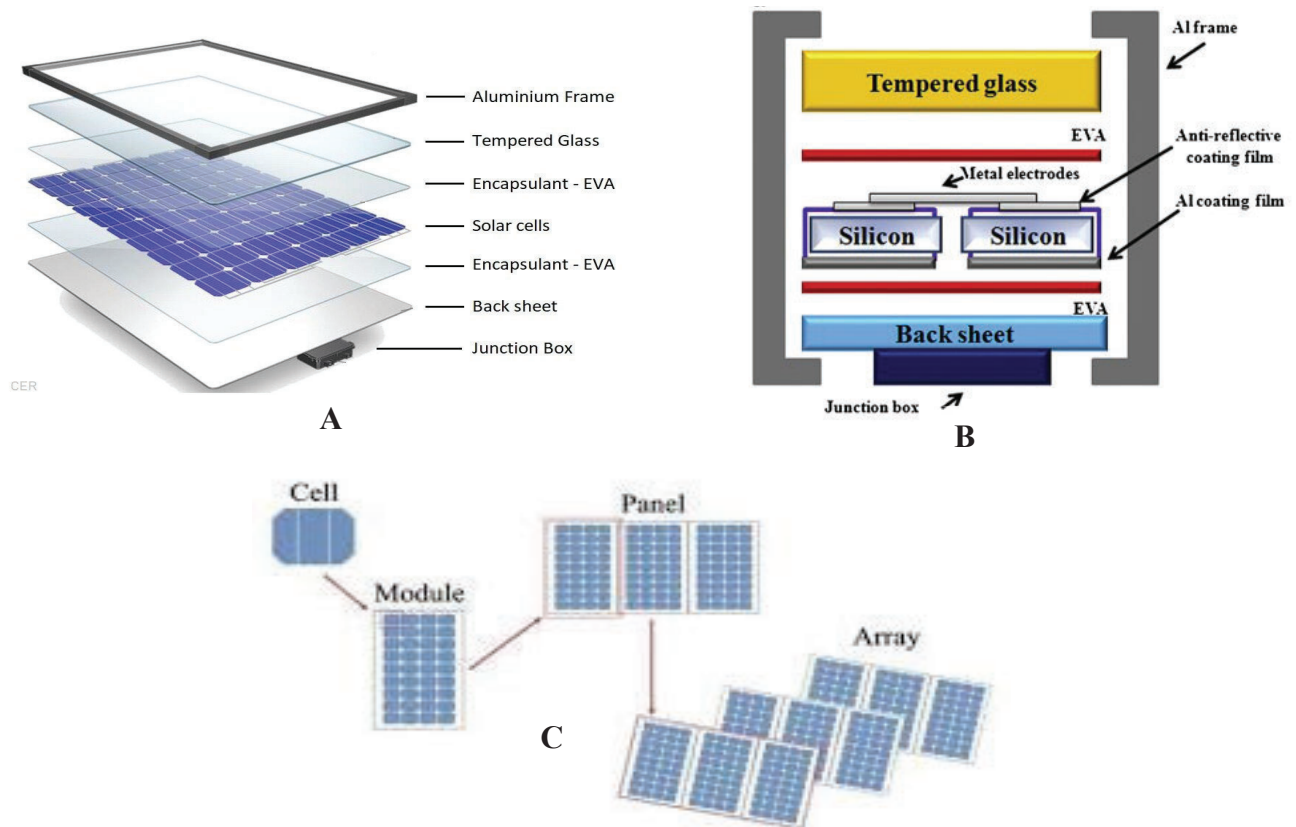

A number of studies were evaluated for their ability to quantify specific materials waste streams associated with potential recycling of the c-Si modules. Figure 2 summarizes those reports, several conducted in the past five years, and provide sufficiently accurate compositions of crystalline silicon (c-Si) modules [1, 10-17]. The raw data used to generate Figure 2 is provided in the appendix (Table A1). To be included in our study, reports had to present, in addition to weight percent of specific components, the weight and peak power of specific module analyzed. This allowed the material composition data to be presented as a function of kilowatt rating at standard condition [22]. Values varied significantly and most studies did not report on all materials expected to be found in the module. Some, for example, did not report Si. These variations are attributed to variations in sampling procedures as well as relative efficiencies of the extraction/purification/analysis methodologies used. In some cases, reports only sampled 1-cm cross sections of the actual solar module which can lead to variation across modules. Moreover, most methods for the extraction and analytical quantification of recovered metals are not 100% effective.

Despite those inconsistencies, several trends emerge. The major elements of a c-Si module are glass (~68%), aluminum (~15%, mostly frame), polymer (~7%, which includes the encapsulant (EVA) and back sheet (Tedlar)) although glass is projected to largely replace Tedlar by 2027 [23], as well as valuable elements such as high grade silicon (~3%), copper (~0.6%), an assortment of additional metals (~1.0% in aggregate) including aluminum, zinc, lead, tin, and silver (soldering), and finally magnesium (present in anti-reflectance coatings) [9]. While, the average weight density (kg per kW_{dc}) is in-line with values reported elsewhere [24], the composition of the modules reported in Table A1 will change along with the advancement of new technologies [25]. For example, the use of plastic to replace aluminum as a material for framing is expected to become prominent by 2030 [23]. Moreover, the world market share of lead-containing soldering for cell interconnections is predicted to decrease from over 90% in 2019 to less than 40% by 2030 [23].

Finally, copper is used extensively in wires and cables that connect the PV modules in series and with ancillary components such as inverters. The composition of these materials is discussed below (Note: copper in cables was not accounted for in Figure 2). In addition, junction boxes often found on the underside of a solar module and used to provide a way to connect multiple modules together to form a single system, are mostly made of plastic.

Figure 2. Material composition of an averaged c-Si module.

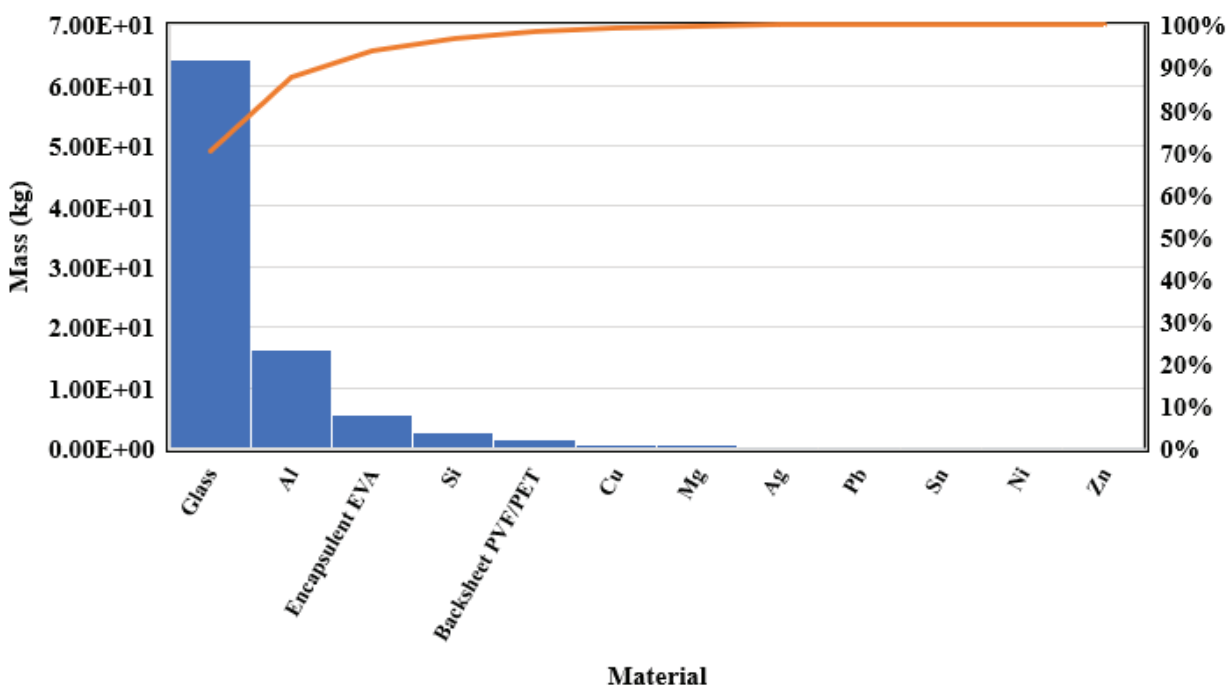

PV ancillary components. PV modules are either rooftop or ground mounted. For rooftop PV applications, the ancillary components typically include inverters, mounting structures, cables/wiring, and connectors [26]. Large (i.e., utility-scale) ground mounted PV installations require additional equipment such as transformers and other items not covered in this study such as concrete [26]. Inverters convert the direct current (DC) generated by the PV modules to grid frequency alternating current (AC) [25]. Transformers “step-up” or “step-down” energy voltage from alternating current sources and are used to support connection. Batteries for storage are discussed separately (below) because they are not used in all PV systems as they can operate within a power grid without batteries (e.g., residential and commercial systems installed under net-metering agreements).

There are three main types of inverters: stand-alone inverters, grid-connected (i.e., grid-tie) inverters, and battery backup inverters [27]. Stand-alone inverters run the electrical devices within the system but are not connected to the grid. Grid-connected inverters are connected to the grid and are designed to automatically disconnect and shut down when there is a loss of utility supply. They also do not provide backup power during power outages. Battery backup inverters are a combination of the previous two types. This study assumes grid-tie inverters.

Grid-connected PV inverters can be categorized into AC-module microinverters, central inverters, string inverters, and multistring inverters (Figure 3) [28, 29].

AC-module microinverters are approximately the size of an internet router, convert the power generated by the specific individual solar module from DC electricity to 240V AC electricity, and are connected directly to and underneath the individual solar module (Figures 3A and 6A). Microinverters are best suited for roofs that suffer partial shading because shade that affects one module will not affect the remaining unshaded modules. They are also useful on roofs that are too small to enable a string of modules to be installed. Micro inverters have now been used for several years and offer a growing alternative to string inverters.

Central inverters "centralize" the power produced by the solar array and are extremely large, converting between 500 kilowatts to 2.5 megawatts each. When connected to central inverters, the PV modules are divided into series connections (called a string) that are connected in parallel through string diodes to the DC side of a single central inverter whose AC output is connected to the electrical grid (Figure 3B). The central inverter has a high-capacity inverter designed for use with large commercial and/or utility (power station) sized solar systems (Figure 6C). While central inverters are similar to large string inverters, they are designed to manage more power and offer efficiencies/economies of scale. Central inverters are typically not used for residential solar systems.

The *string inverter* is a reduced version of the central inverter. A string inverter connects a single series or "string" of solar modules to the electrical grid (Figure 3C). In this configuration, a single string of PV modules is connected to a dedicated string inverter. A string inverter will usually be located a short distance away from the array in a sheltered location between the solar array and the switchboard (Figure 6B). Along with microinverters, string inverters are the most common type of inverter used in residential and small to medium commercial systems.

The *multi-string inverter* is the further development of the string inverter wherein several strings are interfaced with their own DC–DC converter to a second "common" DC–AC inverter (Figure 3D). Although utility-scale solar farm systems have traditionally used centralized inverter architectures [30], string inverter architectures (single string or multi-string) are now increasingly used in utility-scale solar farms as the topologies of utility-scale PV inverters are moving towards multilevel structure [31, 32].

Figure 3. Topology of the microinverter (A), central inverter (B), string inverter (C), and multi-string inverter (D) [29].

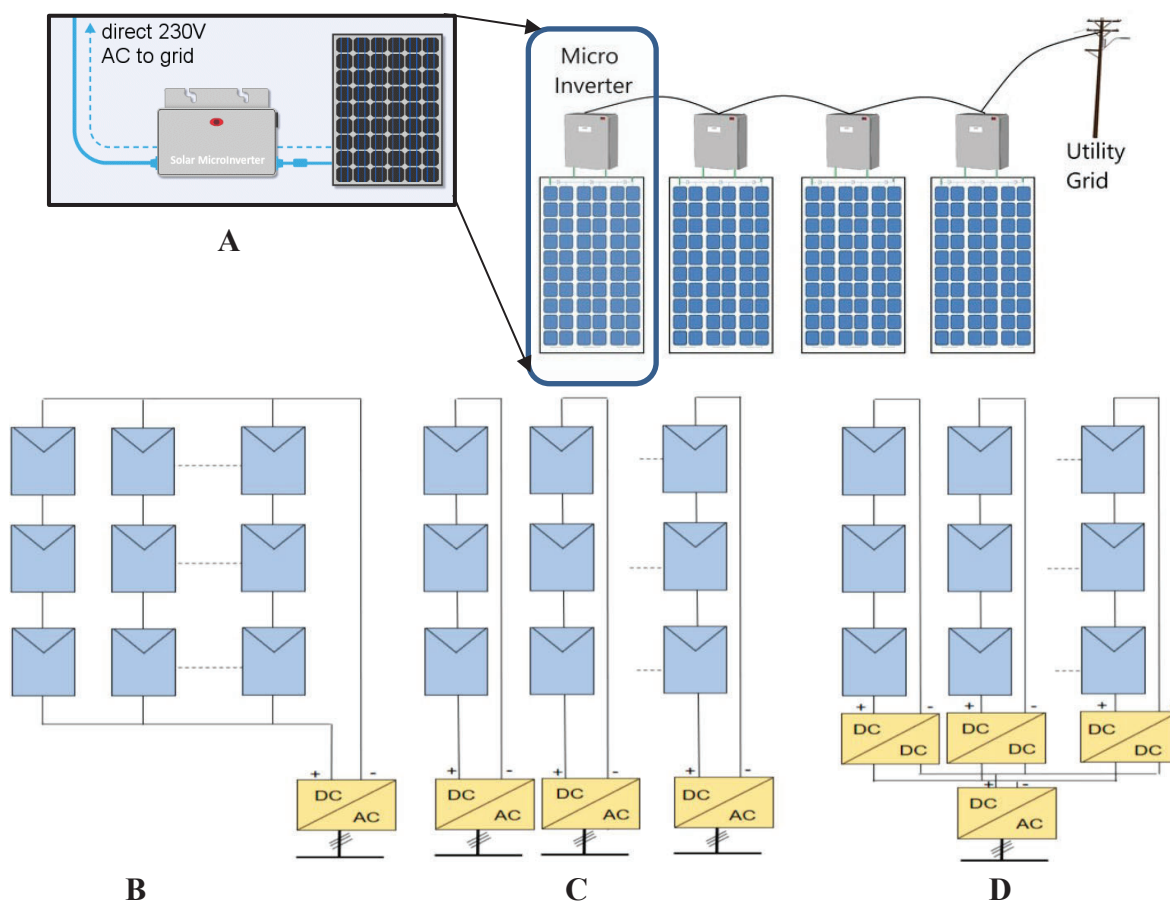

Inverters typically consist of a transformer and electronic components such as control circuits, drive circuits for the power devices, oscillator, switching devices, casing, and connectors [33]. The average material composition across these components is presented in Figure 4 based on a limited number of reported 500 kW-ac string inverters [25, 34]. The underlying raw data with averages is presented in the appendix (Table A2). In general, the data shows that the principle materials of large scale inverters are copper, steel, and aluminum followed by trace amounts of precious (Ag, Au), base and special (Al, Sn, Zn, Ta, Mn, Fe, Ni), toxic (Pb), and critical materials (Mg) [14]. Not surprisingly, the portfolio of the trace metals is similar to the profile of trace metals in electronic waste (Figure A1). Similar values are seen with lower power string inverters (Figure 5, raw data in appendix Table A3) although the ratio (i.e., kg/kW-ac) of each major metal (copper, steel, and aluminum) decreases with increased power rating.

Figure 4. Material composition of generic 500 kW string inverter [25, 34].

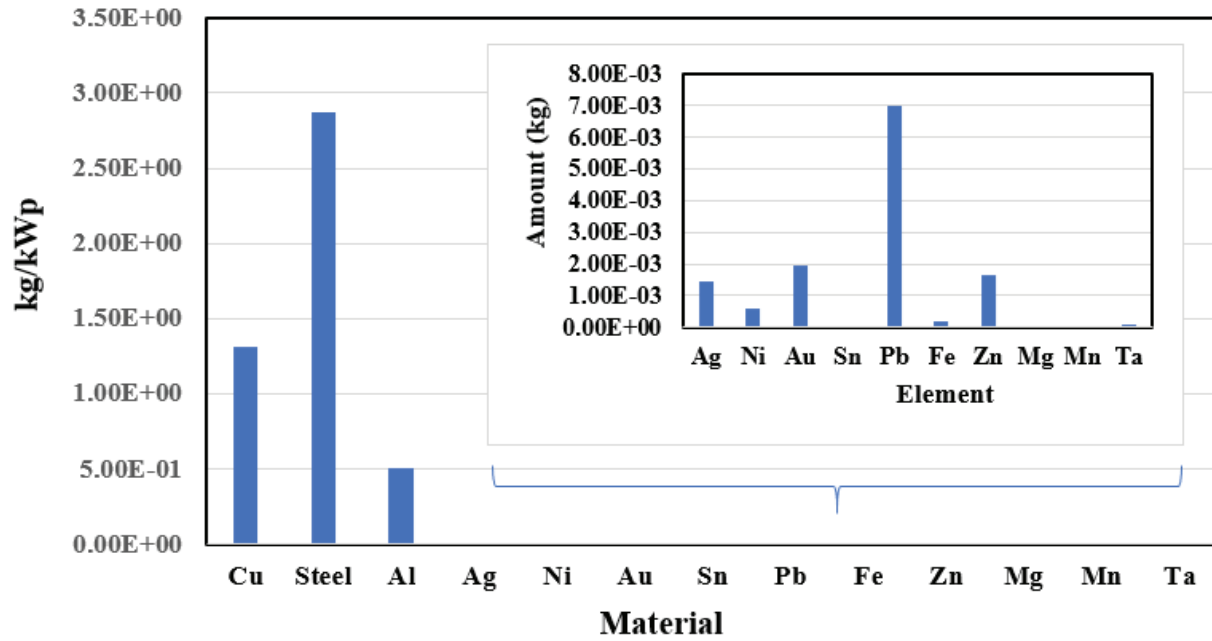
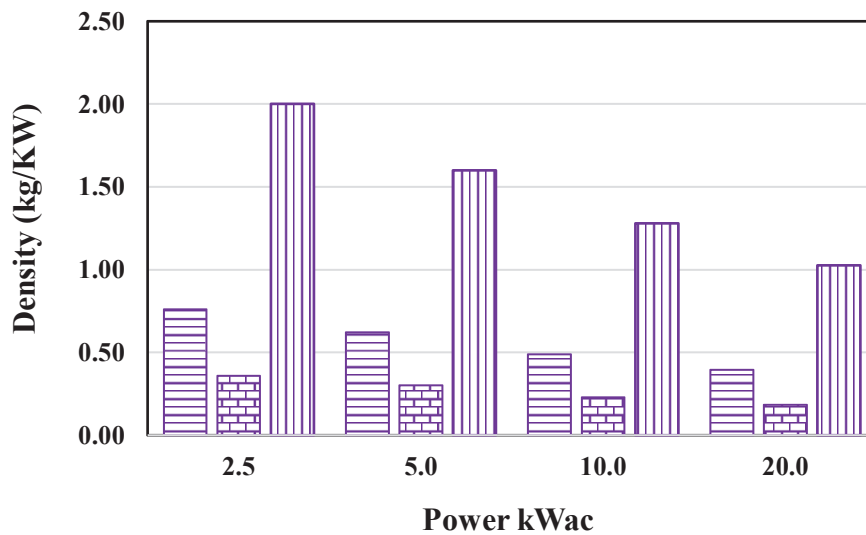

Figure 5. Material composition of low power inverters as a function of power rating [35]. Key: Copper (horizontal lines); steel (mesh); aluminum (vertical lines).



The use of Figure 4 would suggest these compositions are constant irrespective of the inverter. Realistically, however, the material composition of inverters will vary with size, voltage rating, phase, manufacturer, model, and year manufactured. For example, modern microinverter designs use plastic instead of steel housings, transformer-less inverters no longer use large copper cores, and advanced inverter designs have increased the voltage capacity for equivalent circuitry (i.e., weight of the inverter generally decreases with the nominal AC power [36]). The latter has led to increased capacity without increasing the size of electrical components (see Appendix, Communications C1). Finally, there has been a trend to develop and deploy transformer-less inverters in order to obtain both higher efficiencies and very low ground leakage current [37]. While conventional inverters (discussed above) are built with internal transformers that synchronize the DC voltage with the AC output, transformer-less inverters use a computerized multi-step process and electronic components to convert DC to high frequency AC, back to DC, and ultimately to standard-frequency AC.

This trend is evident when examining mass density across all inverter scales. Figure 6 presents the mass density as a function of power rating for microinverters (A), residential/commercial inverters (B), and large utility-scale central inverters (C) (see Appendix, Tables A4 through A6). In all cases, the density decreases with increased power although absolute values are not equivalent across types (i.e., microinverter vs. medium sized central/string vs. large central). This general trend is reinforced by reports in the literature [36]. In 1995, for example, a typical 700 W PV inverter weighed 17.5 kg and possessed a mass density of 25 kg/kW while in 2014, a 25 kW inverter weighed 61 kg and possessed a mass density of 2.4 kg/kW [38]. A Siemens 20 kW three phase 277/480 V inverter possesses a mass density of 1.67 kg/kW while its 40 kW three phase 277/480 V counterpart carries a mass density of 0.89 kg/kW⁶. As new semiconductors and circuit topologies are developed, these variations are expected to continue to sharpen. For example, inverters are expected to be made “smarter” through the addition of advanced monitoring and communication interfaces and utility-scale inverters and are expected to become more efficient with the introduction of new power semiconductors based on silicon carbide technology [38].

⁶ Data acquired from datasheets for SolarEdge three phase inverter for the 277/480V Grid for North America models SE20KUS and SE40KUS.

Figure 6. Mass density of inverters as a function of type and power rating [25, 34].

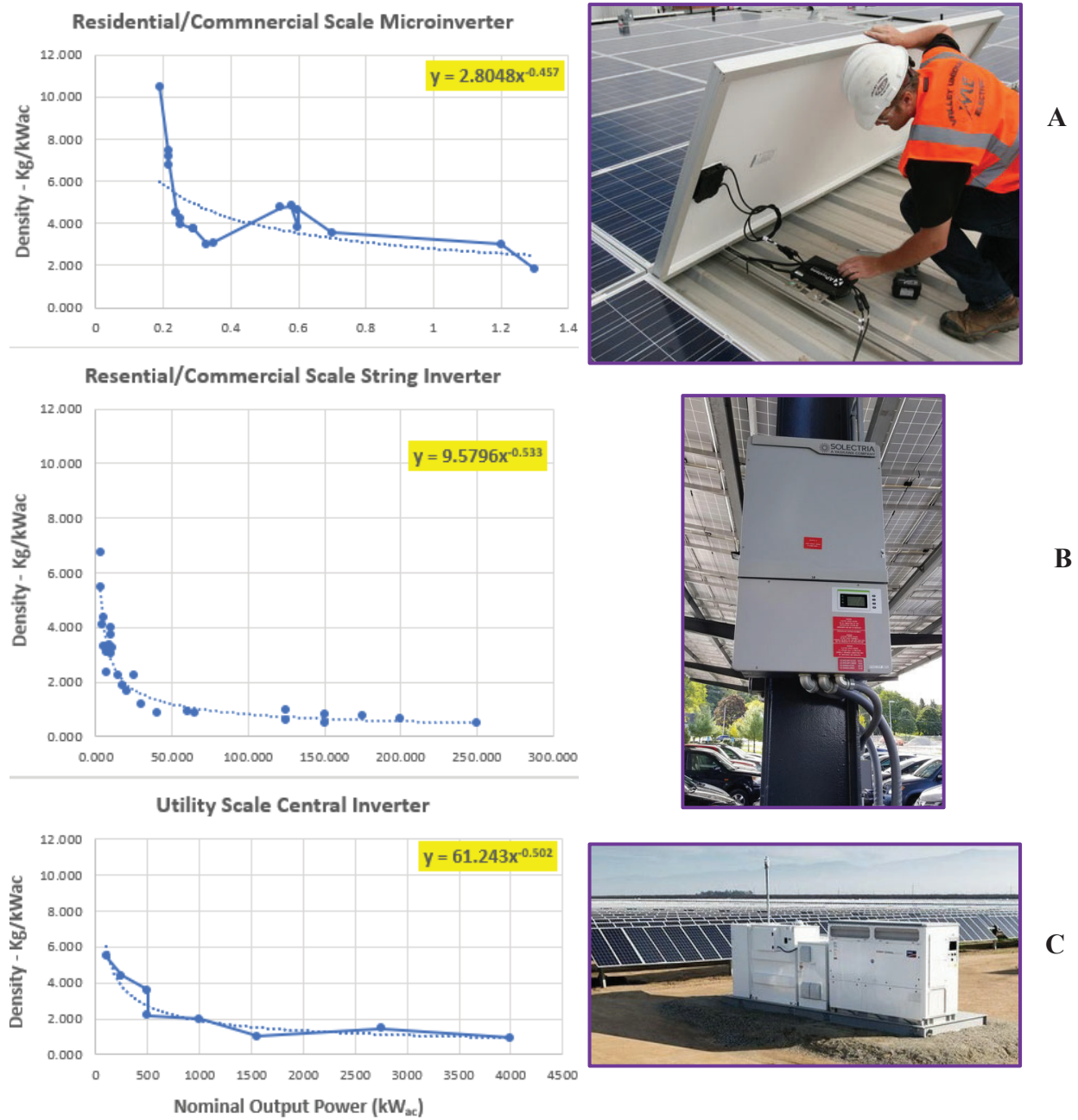

For these reasons, accurate determination of the specific material composition across small to large inverters is unrealistic. However, some generalizations can be inferred. First, the material composition of inverters is comprised of mostly the metals copper, steel, and aluminum (with modern microinverters replacing steel with plastic and string inverters absent the copper) along with trace concentrations of precious, base, and special metals. If quantitative material compositions are required, then Figures 4 and 5 can be used to estimate the material composition of metals for low and high-power inverters, respectively, while Figure 6 can be used to estimate the aggregate total amount of inverter material as a function of kW.

Material streams from mounting structures possess some of the same variability as inverters. Figure 7 presents reports a number of values on material for rooftop and ground mounting structures. These reports span time (~20 years). High variations exist in reported values, in particular for roof mountings (Figure 7A), owing to variations in choice of materials and in building/rooftop designs (i.e., tilt angle, module spacing, array layout [39]). The most recent values, presented in the bottom rows for both rooftop (Figure 7A) and ground mounted installations (Figure 7B) were calculated using a website design program provided by a major manufacturer of mounting structures (IronRidge)⁷. These values are significantly lower than past presentations reflecting industry efforts to shift materials from galvanized steel and/or mild steel to aluminum and its alloys⁸. For example, the modern IronRidge mounting materials use 6000 series aluminum alloys⁹ that use a heat treatable alloy mix of 96% aluminum with silicon and magnesium to create an alloy of excellent extrudability, strength, and corrosion resistance. The extrudability further supports the fabrication of mounting structures with unique structural designs (i.e., a unique curved profile, Figure 7D) that provided enhanced strength at lower weights. It is anticipated that changes in technology, such as frameless mounting structures [40], will emerge, further altering these values.

⁷ <https://www.ironridge.com/>.

⁸ <https://www.ulaginoli.com/solar-energy/an-introduction-to-solar-pv-module-mounting-structures/>.

⁹ <https://taberextrusions.com/6000-series-aluminum-alloys/>.

Figure 7. Material composition of PV solar mounting structures [14, 25, 26, 34, 36, 41-43].

Location	Unit	Stainless steel	Aluminum	Zinc
Rooftop	kg/kWdc	3.42	3.78	NR
Rooftop	kg/kWdc	1.94	18.33	NR
Rooftop	kg/kWdc	6.07	8.2	NR
Rooftop	kg/kWdc	10.9	20.65	NR
Rooftop	kg/kWdc	0.8	8.22	-
Average		4.63	12.36	-
Ground mounted	kg/kWdc	46.6	24.7	1.6
Ground mounted	kg/kWdc	52.4	28.9	1.1
Ground mounted	kg/kWdc	48.9	25.4	1.8
Ground mounted	kg/kWdc	0.2	11.3	-
Average		37.0	22.6	1.5

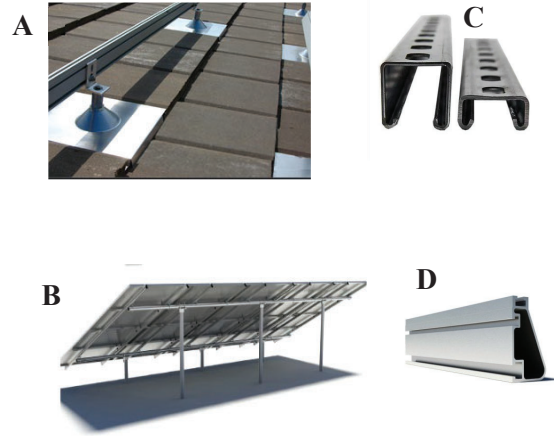

Solar PV cables interconnect solar modules and other electrical components of a photovoltaic system such as the combiner box, inverter, and transfer line. The two most common conductor material used in PV cables are copper and aluminum [25]; copper cables currently dominate the industry. Figure 8 presents reports on material composition as a function of module power [14, 34, 41, 43, 44]. While the expected increase in copper for utility-scale installations occurs, predictions of material composition of PV solar cabling are only an estimate, as their values will vary between installations, e.g., varying roof structure and distance from string inverter (rooftop) and type and location of inverters and wire thickness (utility-scale).

Figure 8. Material composition of PV solar cabling.

Copper	Aluminum
kg/kWdc	
Rooftop	
0.72	-
0.71	-
Ground mounted	
4.712	-
4.43	0.25
5.86	-
4.26	-



Energy Storage Systems

This section presents a review of battery energy storage systems of interest for Hawai'i and a brief description of the ancillary equipment found in a typical installation. This sections also estimates the material composition on a standardized basis of weight of material per kwh of energy storage.

Batteries. Batteries are a dominant technology for application in electric vehicles (EV) and PV power systems [45, 46]. Batteries used on the electric grid capture surplus energy generated by PV systems to allow energy storage for later use during periods of low generation. Batteries can also provide power when electrical loads require more power than the PV modules are generating. Batteries also help establish the DC operating voltage for the required auxiliary components in the connected PV systems.

There are several key components to the battery cell: the *cathode*, *anode*, *electrolyte*, *current collectors*, *casing*, and *separator* (Figure 9) [47-51]. During discharge, the cathode (also termed the positive (+) terminal or electrode) acquires (i.e., gains) electrons that flow (to it) from the anode through an external circuit. The anode (also termed the negative (-) terminal or electrode) is the electrode that releases (i.e., loses) the electrons to the external circuit. The process is reversed when the battery is charged. To maintain charge balance, ions travel through the electrolyte and between the two electrodes during charging and discharging. When a battery cell is charged, for example, electrons travel from the cathode to the anode before moving back again during discharge.

Figure 9. Key components of a lithium-ion battery cell. Image taken from [49].

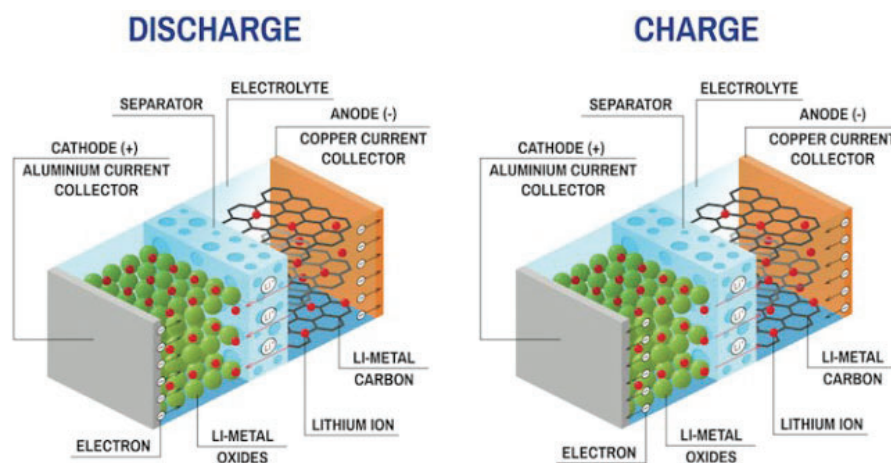

Numerous battery chemistries and configurations are available including well known ones such as lead acid (Pb-Ac), nickel-cadmium (Ni-Cd), nickel-metal hydride (NiMH), lithium polymer [52], and lithium-ion [21]. Compared against nickel cadmium, lead-acid, and nickel-metal hydride batteries, however, lithium-ion batteries (LIBs) are proposed to possess several notable benefits including improved safety [53], use of nontoxic and easily accessible materials [54], better lifetime [46], lower cost [46], reduced supply-chain issues, and decreased environmental impact [55, 56]. As such, lithium-ion batteries (LIBs) have become the dominant technology used in grid-connected energy storage system (ESS) deployments as well as EV applications and it is expected to remain this way for the foreseeable future [51, 57-59]. In Hawai'i, LIB technologies are the dominant technology used for EV, as well as for rooftop, commercial, and utility-scale energy storage systems.

Lithium-ion chemistries use a graphite-based anode [48, 60] and a cathode composed from various lithium metal oxides including lithium-ion phosphate (LFP), Lithium Manganese Cobalt Oxide (NMC), Lithium Nickel Cobalt Aluminum Oxide (NCA), lithium cobalt oxide (LCO), and lithium manganese oxide (LMO) [46, 51, 61-63]. Of these chemistries, NCA and NMC batteries have, until recently, dominated the EV and power market sectors [46]. For example, although some argue the continued marginal role of LFP chemistries with electric vehicles [51], some suggest LFP batteries are regaining greater acceptance [64] (see for example recent announcements by EV producers such as Ford¹⁰, Volkswagen¹¹ and Tesla¹²). LFP batteries are also poised to gain market share in stationary storage within the decade with growth from 10% of the market in 2015 to more than 30% in 2030¹³ [51]. As such, the chemistries of LIBs is expected to keep changing and this complicates disposal and recycling as will discussed in the section *Best Practices for Collection, Disposal, and Recycling of Clean Energy Materials*.

In LIBs, the electrolyte is a mixture of lithium salts and organic solvents [47]. Common lithium salts include lithium hexafluorophosphate (LiPF₆), lithium perchlorate (LiClO₄) and lithium hexafluoroarsenate (LiAsF₆), with LiPF₆ becoming the most common. Common organic solvents include ethyl methyl-carbonate (EMC), dimethyl-carbonate (DMC), diethyl-carbonate (DEC), propylene-carbonate (PC), and ethylene-carbonate (EC) [65]. The current collectors (i.e., positive or negative electrode base) are components that bridge the electrical current to external circuits [50]. The positive current collector is typically made of aluminum while the negative current collector is typically composed of copper. The casing (otherwise known as "housing" or "shells") is a mechanical structure that encloses the internal components. The separator is a component placed between the cathode and the anode that prevents their direct contact, i.e., short-circuiting,

¹⁰ <https://www.autoevolution.com/news/ford-details-ev-strategy-ford-plan-includes-li-ion-lfp-solid-state-batteries-162005.html>.

¹¹ <https://www.reuters.com/article/us-volkswagen-electric-at-home/column-volkswagen-powers-up-for-the-electric-vehicle-revolution-idUSKBN2BG2MN>.

¹² <https://techcrunch.com/2021/10/20/tesla-earnings-iron-batteries-evs-globally>.

¹³ <https://www.greentechmedia.com/articles/read/lfp-will-overtake-nmc-for-stationary-storage>.

while enabling the exchange of lithium ions from one side to the other. Common separator materials include the polyolefins such as polyethylene and polypropylene [51].

Figure 10 presents an estimate of weight percentages of LIB components averaged over a range of battery chemistries and technologies taken from the literature and product data sheets. The raw data for this summary is provided in the Appendix (Table A7).

Figure 10. Averaged weight percentage of components in lithium-ion battery cells.

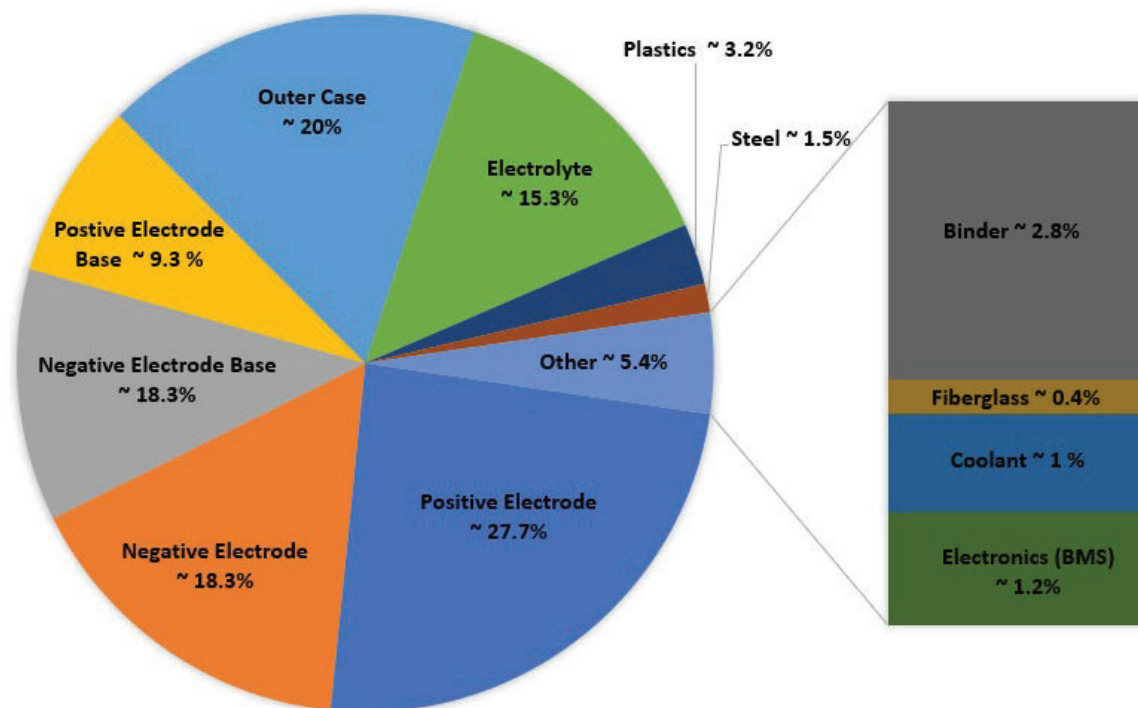

The battery cells are further assembled along with additional components to manufacture the complete battery¹⁴ (Figure 11). The relative weight percentages (wt.%) of the complete battery components will vary between models and manufacturers. This is due, in part, because manufacturers generally decline to report exact numbers in their product data sheets and also because of a large variety of cell configurations (e.g., cell, prismatic, pouch), pack designs, and electrode chemistries are used [51, 66]. Table 1 provides relative weight percentages of components in a complete battery for major lithium-ion battery chemistries. Although the averaged values reported in Table 1 have assumed that the primary casing material is aluminum, some reports suggest steel as high as 40 wt% [67].

¹⁴ Also termed packaged battery or battery module.

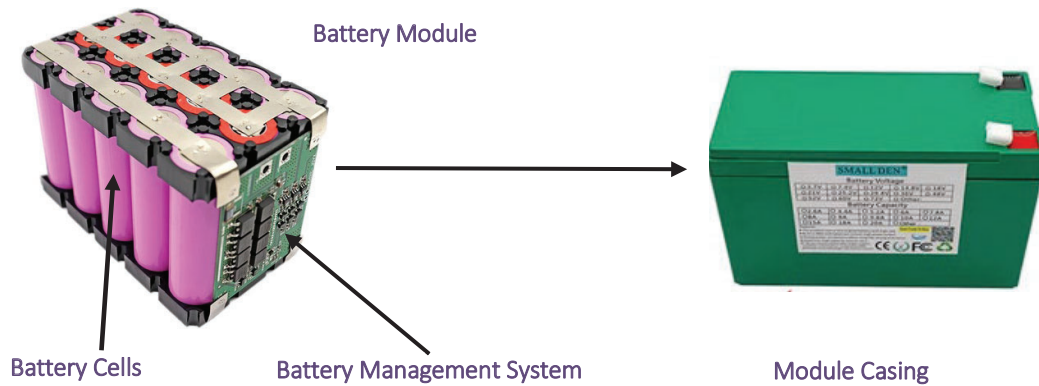
Figure 11. Packaged Lithium-ion battery.*Table 1. Averaged composition of complete battery components for LIB chemistries [68].*

Battery Components	LFP	NMC	NCA	Average
	wt%	wt%	wt%	wt%
Positive Electrode	24	28	31	27.7
Negative Electrode	15	18	22	18.3
Negative Electrode Base	12	11	17	13.3
Positive Electrode Base	10	10	8	9.3
Outer Case	20	20	NR	20.0
Electrolyte	18.5	12.5	15	15.3
Plastics	3.5	3.2	3	3.2
Steel	1.5	1.5	NR	1.5
Binder	2.1	2.4	4	2.8
Fiberglass	0.3	0.4	NR	0.4
Coolant	1	1	NR	1.0
Electronics (BMS)	1	1.3	NR	1.2

The weight percentages provided in Table 1 can be converted to kg per kW by using estimated values of gravimetric or energy density. Table 2 presents an averaged range of energy densities for major lithium-ion chemistries. Battery energy density is the amount of energy a battery contains compared to its weight or size and measures how much maximum energy a battery can hold. There is a strong effort to develop batteries with higher energy densities compared to the practical state-of-the-art [69]. For this and other reasons (i.e., balancing both energy and power density, increasing lifetimes over cycling periods), a broad range of chemistries (cathode and anode electrodes) have been explored and introduced into the market [69]. Among the available battery technologies to date, lithium-ion chemistries best optimize power and energy densities necessary for both electric vehicle and power system applications [69]. For reference, a

comprehensive list of energy density as a function of battery chemistry and scale (cell, module, or BESS system) is presented in the Appendix (Table A8).

Table 2. Estimated energy densities for the five major lithium-ion chemistry [70, 71].

Abbreviation	Full name (chemical formula)	Range of energy density (Wh/kg)
NCA	Lithium Nickel Cobalt Aluminum Oxide (LiNiCoAlO ₂)	200-360
NMC	Lithium Nickel Manganese Cobalt Oxide (LiNiMnCoO ₂)	150-220
LMO	Lithium Manganese Oxide (LiMn ₂ O ₄)	100-150
LFP	Lithium Iron Phosphate (LiFePO ₄)	90-120
LTO	Lithium Titanite (Li ₄ Ti ₅ O ₁₂)	70-80

As shown in Table 2, there is a broad range of lithium battery chemistries. Of these, however, LFP and NMC chemistries have found the greatest penetration in EV applications, in part due to their optimum performance in terms of both power and energy density. For this report, these two are taken to be the major battery chemistries used in Hawai'i EV and average parameter values for both are presented in Table 3 [51, 57].

Table 3. Estimated parameters for dominant lithium-ion battery chemistries [72].

Parameters	Battery chemistry	
	LFP	NMC
Rated capacity (kWh)	28	28
Battery weight (kg)	230	170
Battery's energy density (Wh/kg)	122	165
Quantity of battery cells (#)	100	96

Battery ancillary components. Battery cells are not used in isolation, rather, they are packaged in systems that contain components that also enter the waste stream (Figure 11). Specifically, battery systems or battery packs are composed of individual cells having a nominal voltage of 3-4 volts (depending on the chemical composition), organized in a series and parallel configurations to achieve the desired voltage and capacity [73]. To simplify assembly, individual cells are grouped into stacks called modules. Several of these modules are placed into a single pack. Within each module, the cells are welded together to complete the electrical path for current flow. Modules will require ancillary components such as cooling mechanisms, temperature monitors, and other

devices such as a battery management system (BMS) which controls all aspects of the battery pack protection including thermal and energy management¹⁵ (Figure 11) [51, 73, 74].

The ancillary components (i.e., also termed balance of system (BOS)) will differ between EV and photovoltaic power applications (i.e., Grid Storage). Table 4 presents their representative data for typical ancillary components on a per kW or kWh basis [59]. In addition, the designs of thermal management systems, pack construction, cell sizes, and form factors can differ significantly. Stationary systems, for example, usually require fire suppression systems and often include conventional forced-air HVAC systems [59]. A comprehensive list of ancillary components will also include physical infrastructure such as a container housing or concrete foundations, common for larger, stationary energy storage systems (ESS's) but are not relevant for EV battery packs.

With respect to grid storage (or grid-connected) energy storage systems, the principal ancillary components are the housing (e.g., steel), battery management system (electronics), inverters (steel, aluminum, copper, electronics), cooling systems (e.g., air conditioning unit operations), insulation (e.g., typically hard plastic or acid-resistance cloth), and fire suppression (e.g., foam or water mist distribution system). For EV packs, the list is similar except the cooling systems are comprised of liquid coolant (e.g., glycol), insulation made of fiberglass, and fire suppression is not used.

Table 4. Composition of ancillary components of a representative lithium-ion battery for a representative hypothetical grid-scale LIB-ESS (1 MW, 4 MWh) and an EV battery pack (225 kW, 73 kWh, similar to the Tesla Model S battery pack [59]).

System component	Material	Grid Storage		EV pack	
		kg/kW	kg/kWh	kg/kW	kg/kWh
Housing	Steel or Aluminum ¹	8.10	2.00	0.15	0.45
	Plastics	-	-	0.03	0.1
BMS	Electronics	0.04	0.01	0.002	0.005
Inverter	System	1.10	0.28	-	-
Cooling System	System	0.43	0.11	-	-
	Coolant	-	-	0.02	0.06
Insulation	Fiberglass	-	-	0.02	0.02
Fire Suppression	Steel	0.25	0.06	-	-
	Fire Suppressant	0.07	0.02	-	-

¹ for EV packs only

¹⁵ Battery management systems, for example, are designed to maintain the optimum operating temperature by controlling how fast the batteries charge and discharge.

Solar Hot Water Systems

This section presents a review of solar water heater systems of interest for Hawai'i and a brief description of the ancillary equipment found in a typical installation.

Solar hot water panels. The two conventional solar collector types are concentrating and non-concentrating collectors [75]. Non-concentrating collectors use the common area to absorb and intercept the sun radiation for active heating of water while concentrating solar panels use multiple surfaces to intercept and absorb higher radiation flux [75]. While concentrating collectors are more efficient, they are also more likely to be more useful for higher temperature applications such as power generation and industrial use and are therefore not considered in this study. With respect to non-concentrating solar collectors, there are two main types: flat plate and evacuated tube collectors. Evacuated tube collectors have also been proposed for domestic solar water heating systems but are not commonly available. Flat plate collectors work well in climates such as Hawai'i where it rarely freezes. This study assumes flat plate non-concentrating solar collectors are the primary technology used in Hawai'i. While advanced technologies that combine both solar and solar photovoltaic technology to generate heat and electricity are emerging [76], they are not considered in this study.

Flat plate collectors are framed boxes with a transparent glazing cover that sits over the dark-colored absorber plate on top of which lay pipes or tubes, called risers (Figure 12). Until about 20 years ago, the absorber sheet was almost always made entirely of copper, which is one of the best thermal conductors known [77]. The next best readily available conductor for the sheet is aluminum. Most solar water heaters still have copper water pipes [77]. The pipes, typically copper, run length-ways across the absorber plate and contain the heat transfer fluid, typically water, being heated. The copper pipes are also bonded, soldered, or brazed directly to the absorber plate to ensure maximum surface contact and heat transfer. As the plate gets hotter, this heat is conducted through the risers and absorbed by the fluid flowing inside the copper pipes which is then transferred to the storage tank or water heater. The pipes and absorber plate are enclosed within a metal box with a sheet of glazing material, either glass or plastic, on the front to protect the enclosed absorber plate and create an insulating air space. The space between back and sides of the absorber and the box is filled with insulation to reduce heat losses. Insulation material for flat plate collectors is generally polystyrene or polyurethane foam [77]. Finally, the front of the box is covered with a high transmittance glass plate. Low-iron glass has the highest transmission and lowest reflection of sunlight [77].

Solar hot water ancillary components. Solar hot water ancillary components include storage or water heater tanks, pumps, mounting hardware, racks, and in some cases advanced differential controls (Figure 13). Storage or water tanks are generally ASME rated steel with options around lining material and insulation thickness. Pumps, which circulate fluid through the collectors, are

comprised of copper, stainless steel, plastic, electronics, and small amounts of glass. Mounting systems are made of aluminum, stainless steel, or a combination. The controls are generally comprised of typical electronics to optimally schedule heat pump heating cycles [78].

Figure 12. Flat plate solar water heater panels.

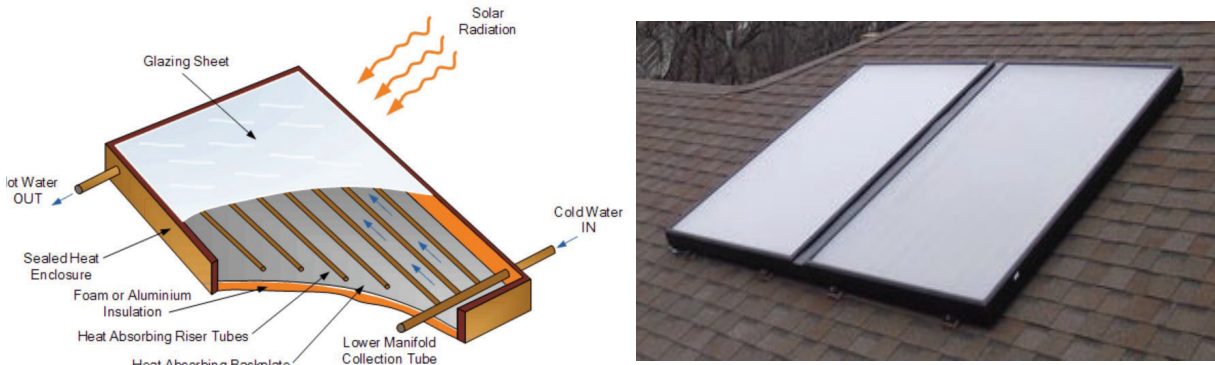
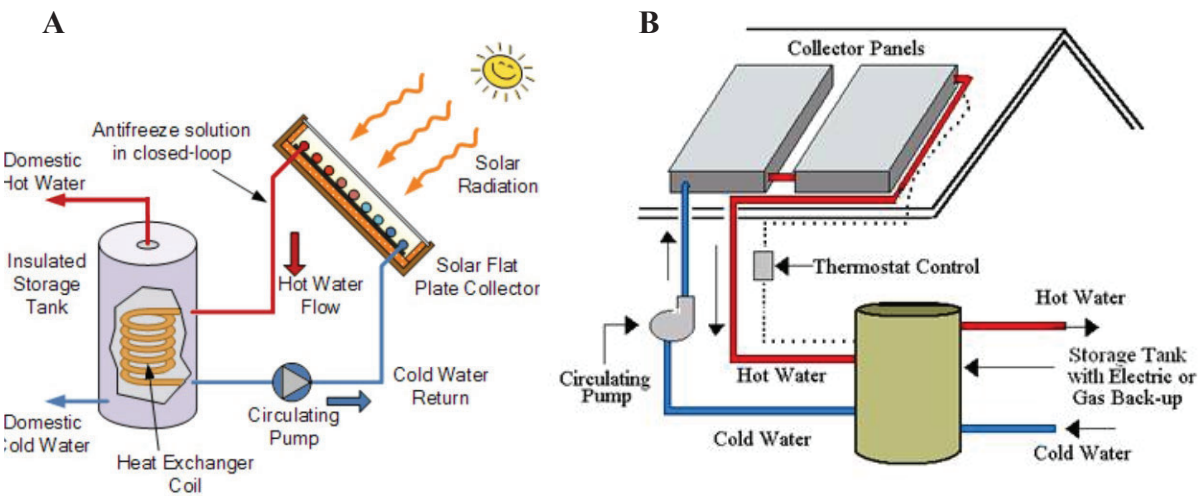

Figure 13. Ancillary components of typical solar water heater system: (A) flat plat panel connected to water heater and working fluid household water and (B) flat plate panel connected to storage tank with internal heater exchanger and working fluid a mixture of water/polypropylene glycol (60:40).



ASSESSMENT OF PENETRATION IN HAWAI'I

This section quantitates the current penetration of aging solar photovoltaic (PV), energy storage (PV and electric vehicle), and solar hot water systems and provides a limited and estimate of their future potential deployment through the year 2045. A variety of state agency and utility resources have been used to produce these estimates including the International Energy Agency, Hawaiian Electric, and the Kaua'i Island Utility Cooperative. Data on penetration of PV and battery storage are reported for systems installed through 2021, both as a function of scale (i.e., residential, commercial and utility) and location (i.e., O'ahu, Maui County, Hawai'i County, and Kaua'i). While not expressly required by Act 92, minor comment is also given to future penetration predicted to be installed between 2022 and 2045. These data are presented as a function of scale (aggregated residential plus commercial and utility) and location (O'ahu, Maui County, Hawai'i County, Kaua'i). These predictions are speculative, however, and should be used with caution due to the many difficult to quantify variables that will dictate Hawai'i's pathway to 100% renewable energy and electrified transportation.

Photovoltaic Systems

Photovoltaic penetration. Solar PV penetration is presented on three scales of deployment: *Residential*, *Commercial*, and *Utility*. Following a report by the National Renewable Energy Laboratory (NREL) [79], residential PV systems refer to those at residences (roof-mounted, generally under 10.0 kW). Commercial PV systems refer to those on businesses or serving businesses (roof-mounted, generally between 10.0 kW and 2.0 MW). Utility PV systems refer to those that sell power to the utility under a power purchase agreement or other Hawai'i Public Utilities Commission approved program (i.e., Feed-In Tariff, Standard Interconnection Agreement (ground-mounted, generally over 2.0 MW)) [79].

Data for existing penetration across islands and scale have been obtained through Hawaiian Electric Company (HECO) [80], Kaua'i Island Utility Cooperative (KIUC)¹⁶, and U.S. Energy Information Administration (EIA, forms 860 and 861¹⁷) web-based databases. The data is presented in units of energy capacity (MW_{ac}) so as to follow established practices that estimate quantities of material waste streams using installed MW_{ac} [6, 14, 25, 81].

Figure 14 presents the cumulative installed PV through 2021 for all islands as a function of scale. The raw data is presented in the Appendix (Table A9). While off-grid installations have occurred, particularly in Hawai'i County, their overall contribution is low and the lack of data (on them) have precluded them from being included in this report (see Appendix, Communications C2). There was a significant jump in residential and commercial penetration between the years 2013

¹⁶ Data courtesy of Jonah Knapp, Kaua'i Island Utility Cooperative.

¹⁷ Data pulled from <https://www.eia.gov/electricity/data/eia861/> and <https://www.eia.gov/electricity/data/eia860/>.

and 2018 while a significant jump in utility penetration was observed between the years 2016 and 2019. The sole exception was for Hawai'i County which see no utility-scale installations prior to the time data was gathered for this report. The cumulative installed PV through 2021 is estimated to be just under 1,200 MW across all islands and scale: 536.4 MW for residential, 378.3 MW for commercial, and 284.5 MW for utility (Figure 14, Table A9). For context, the estimated cumulative U.S. mainland installation in 2020 totaled 68,276 MW [82]. As such, Hawai'i penetration is just at 1.5% that of the mainland U.S., suggesting that access to and guidance on recycling should be increasingly available from the U.S. mainland.

The data presented in Figure 14 and Table A9 for the island of Kaua'i was obtained from the EIA¹⁸. The accuracy of this data was checked against data obtained from KIUC (Figure A2)¹⁹. In 2021, the data from KIUC is within 95% of residential data pulled from IEA (Figure 14, Table A9) and within 98% of the commercial data pulled from IEA (Figure 14, Table A9), giving confidence in the use of data pulled from IEA.

¹⁸ Data pulled from <https://www.eia.gov/electricity/data/eia861/> and <https://www.eia.gov/electricity/data/eia860/>.

¹⁹ Data courtesy of Jonah Knapp, Kaua'i Island Utility Cooperative.

Figure 14. Cumulative installed PV through 2021. Legend: Residential (A); Commercial (B); Utility (C); all islands (D). Data from Hawaiian Electric project status board (O'ahu, Hawai'i County, Maui County) and IEA (Kaua'i).

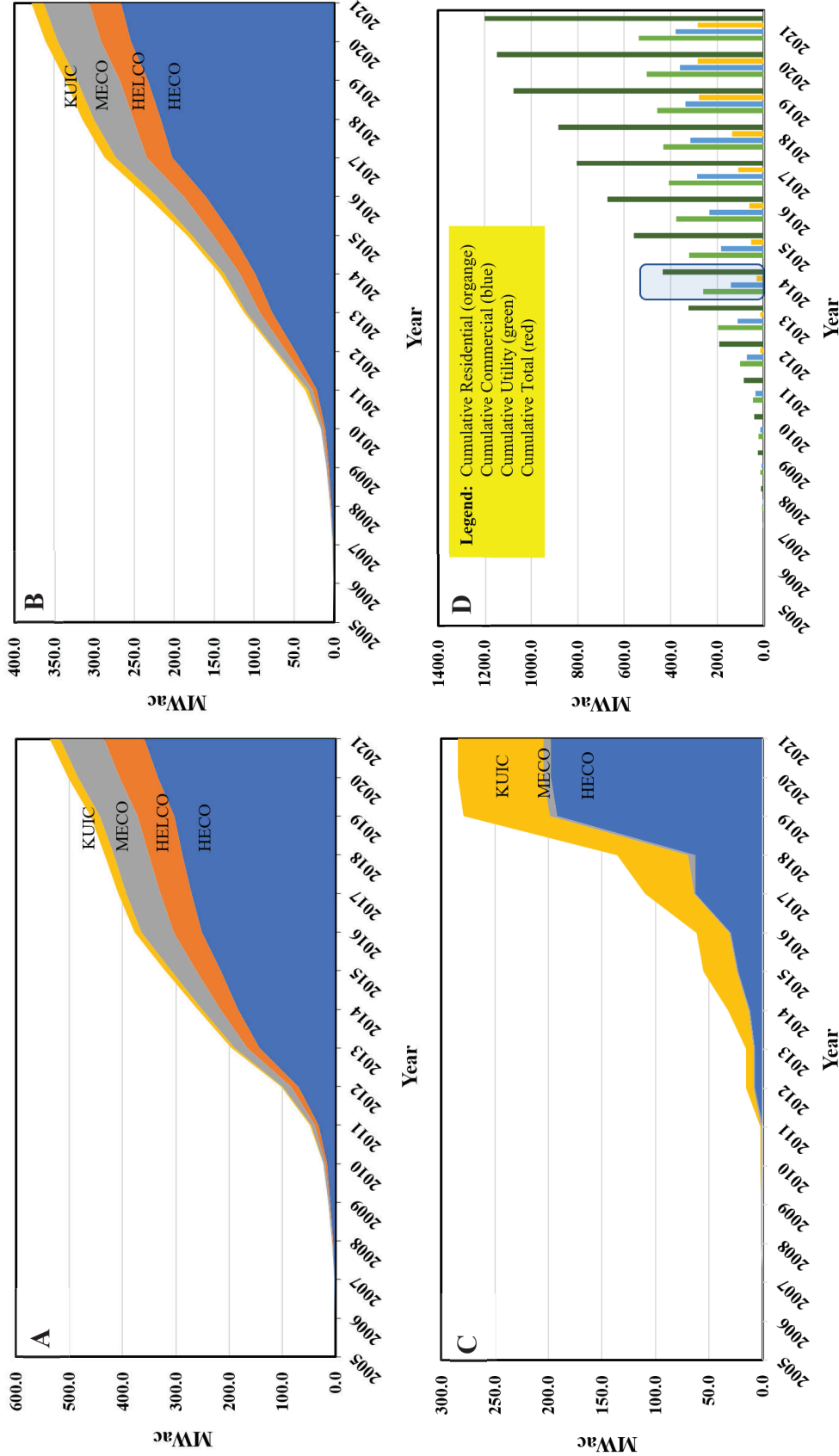

Photovoltaic modules. To estimate the number of cumulative modules installed through 2021, three assumptions were used: the DC/AC ratio was 1.4, the average residential module power rating was 250 W_{dc}, and the average commercial/utility module power rating was 350 W_{dc}. The results are presented in Table 5. As of 2021, it is estimated that 3.86 million modules have been installed on O'ahu, 720,000 in Maui County, 580,000 in Hawai'i County, and 480,000 on Kaua'i. The assumptions underlying these calculations, however, can be expected to vary going forward as the underlying PV technology advances. For example, the power rating of a typical 1.7 m² rooftop module in 2019 can be expected increase by 16% by 2030 [23].

Table 5. Estimated total PV modules installed across scale and island through 2021.

Scale	Island			
	Oahu	Maui	Hawaii	Kauai
Residential	2.01E+06	4.63E+05	4.29E+05	1.04E+05
Commercial	1.07E+06	2.30E+05	1.58E+05	6.00E+04
Utility	7.91E+05	2.80E+04	0.00E+00	3.20E+05
Total	3.86E+06	7.20E+05	5.86E+05	4.84E+05



Photovoltaic ancillary components – inverters. The number (and type) of inverter(s) will vary with the installation. Current rooftop PV installations, for example, will have used micro *or* string inverters. Commercial scale PV systems, by contrast, will more likely have used string inverters. Moreover, to ensure that the inverter operates at its maximum output, most PV arrays are typically oversized to provide an inverter-sizing ratio factor (ISRF) of 1.15 [83, 84]. Using this value, the number of inverters can be estimated using Equation 1 [25].

$$\text{Inverters (\#)} = \frac{\text{PV Array Capacity (Wdc)} * \text{ISRF}}{\text{Maximum Inverter Output Capacity (Wac)}} \quad (1)$$

With respect to residential inverters, the PV capacity should reflect the market share of micro to string inverters. Currently the two dominant brands in Hawai'i are Enphase (micro) and Solar Edge (string). As of early 2021, the national market share of Enphase was 48% compared to 40% for Solar Edge [85]. While the historical split in Hawai'i will have some variation, these numbers can be used to produce a reasonable estimate of inverters installed through 2021. Table 6 presents this estimate using Equation 1 and the stated assumptions. When calculating the number of inverters at commercial scale, it was assumed that all commercial scale installations used string/central inverters.

Table 6. Estimated number of installed inverters across all islands through 2021.

Assumptions		Estimated inverters (all Islands)	
Inverter Rated Capacity	kW _{ac}	Type	#
Residential microinverter	0.2	Residential Microinverter	1.48E+06
Residential string inverter	5	Residential String Inverter	6.4E+04
Commercial inverter	25	Commercial Inverter	1.7E+04
Utility central inverter	2860	Utility Inverter	1.1E+02
Inverter Sizing Ratio Factor	1.15		
Type	%		
Residential microinverter	0.48		
Residential string inverter	0.52		
Cumulative Installed PV	MW _{ac}		
Residential	536.4		
Commercial	378.3		
Utility	284.7		



Equation 1 is used to estimate the number of installed inverters to be estimated using the value of installed MW_{ac}. As discussed above, this approach is complicated by the reality that for residential installations either micro and string inverters are deployed. As all inverters are tracked online by their manufactures, data at residential scale can be obtained directly by their manufacturers. This approach, however, is complicated by the reality that manufacturers are reluctant to share data on the market penetration of their products. That being said, Enphase did provide the number of installed Enphase microinverters as a function of year²⁰. Given that in Hawai‘i the dominant microinverter used at residential scale was manufactured by Enphase, these numbers were used as a check on the numbers calculated using Equation 1 (Table 6). The raw data is presented in the Appendix (Table A10). The Enphase data indicates a total of 1,594,750 micro inverters have been installed across all islands through 2021, which suggests our estimates based on MW_{ac} data to be within 93 percent accuracy.

In addition, HNEI was also able to get data from KIUC regarding the number of inverters on Kaua‘i (Figure A3). When using this data to check the numbers calculated using Equation 1, it should be noted that the KIUC data includes battery and inverters in addition to micro and string inverters and thus will present slightly high estimates. Nonetheless, the data obtained suggests the number of residential inverters on Kaua‘i (as of 2021) is 41,510 or 2.7% of all residential micro and string inverters installed across all islands and the number of commercial inverters is 7,676 or 44% of all commercial inverters installed across all islands. While these numbers include battery inverters, the low number of residential inverters tracks the relatively low residential penetration on Kaua‘i by 2021 (18.6 MW compared to 517 on O‘ahu, Maui County, and Hawai‘i County,

²⁰ Data courtesy of John Berdner, Enphase.

Table 9). The percentage of commercial inverters on Kaua‘i, however, appears unusually high at 44% and could reflect a decision to use far more microinverters at commercial scale as opposed to string inverters (see Appendix, Communications C3).

Photovoltaic ancillary components – transformers. Utility-scale installations will also employ transformers downstream of the inverter. At utility-scale the number of transformers is estimated using Equation 2 and a transformer power factor (TPF = (kW/kVA)) of 0.8 [83].

$$\text{Transformers (\#)} = \frac{\frac{\text{PV Capacity (kW}_{ac})}{\text{TPF } \left(\frac{\text{kW}_{ac}}{\text{kVA}}\right)}}{\text{Transformer Capacity (kVA)}} \quad (2)$$

Assuming a typical utility-scale project using transformers rated at 1,250 kVA [83], and an installed utility-scale capacity (MW_{ac}) of 197, 0.0, 7.0, and 80 on O‘ahu, in Hawai‘i County, in Maui County, and on Kaua‘i respectively (Table A9), the number of installed utility-scale transformers, as of 2021, is estimated to be 198 on O‘ahu, 0.0 in Hawai‘i County, 7 in Maui County, and 80 on Kaua‘i.

Photovoltaic ancillary components – mounting structures. Mounting structures, both rooftop and ground, can vary with the design and scale of each specific installation [36, 39, 86]. Table 7 presents an estimate of the amount of materials contained in mounting structures. These calculations assume averaged values (kg/kW_{dc}) of 5.6, 12.7, and 0.0 for rooftop installed steel, aluminum, and zinc respectively, and 49.3, 22.6, and 1.5 for utility-scale installed grounded mounted systems (Figure 7). They also assumed a DC/AC loss factor of 1.4 [79]. This value is an upper (oversized) estimate that is more suited to utility-scale. Residential scale can trend downward to 1.15. In total, the estimates suggest a total installation through 2021 (across all scales) of 35.1 million kg (77 million pounds) of steel and aluminum installed on O‘ahu, 4.12 million kg (8.2 million pounds) on Maui, 2.83 million kg (5.66 million pounds) in Hawai‘i County, and 8.87 million (17.6 million pounds) on Kaua‘i (Table 7). To check the values in Table 7 are reasonable, the amount of material per rooftop was calculated as a check. It is assumed that 358.6 MW_{ac} of residential rooftop installed PV is installed on O‘ahu through 2021 (Table A9), and the average installation is 5,000 W (5 kW) per rooftop, these estimates equate to approximately 71,000 rooftops with installed PV solar on O‘ahu. When combined with the values in Table 7, this suggests an estimated use of ~40 kg (88 lb.)²¹ of steel and ~85 kg (186 lb.) of aluminum *per* rooftop installation. This check indicates the numbers are sensible and confirms the reasonableness of the overall numbers presented in Table 7.

²¹ 2.8 million kg/70,000 rooftops = 40 kg.

Table 7. Estimation of cumulative solar PV mounting structure materials installed through 2021.

Material	Oahu	Maui	Hawaii	Kauai
	Residential Rooftop Mounted (kg)			
Steel	2.80E+06	6.46E+05	5.98E+05	1.46E+05
Aluminum	5.94E+06	1.37E+06	1.27E+06	3.09E+05
Zinc	-	-	-	-
Commercial Rooftop (kg)				
Steel	2.08E+06	4.49E+05	3.08E+05	1.17E+05
Aluminum	4.42E+06	9.51E+05	6.54E+05	2.49E+05
Zinc	-	-	-	-
Utility Ground Mounted (kg)				
Steel	1.36E+07	4.83E+05	0.00E+00	5.52E+06
Aluminum	6.25E+06	2.21E+05	0.00E+00	2.53E+06
Zinc	4.16E+05	1.47E+04	0.00E+00	1.68E+05
Total	3.51E+07	4.12E+06	2.83E+06	8.87E+06



Photovoltaic ancillary components – cabling. Similar to mounting structures, cabling design can vary across both rooftop and ground mounted installations. Using the data presented in Figure 8, the amount of cabling material estimated across installations using calculations comparable to those used with mounting structures. The results are presented in Table 8. These calculations assumed averaged values (kg/kW_{dc}) of 0.715 for rooftop installed copper respectively, along with 4.82 and 0.25 of copper and aluminum, respectively, for utility-scale installed grounded mounted systems (Figure 8). They also assumed a DC/AC loss factor of 1.4 [79]. This value is an upper (oversized) estimate that is more suited to utility-scale. Residential scale can trend downward to 1.15. Similar to the check performed on mounting structures, these numbers yield the reasonable use of 5 kg (11.1 lb.) of copper cabling per rooftop installation on O‘ahu.

Table 8. Estimation of cumulative solar PV cabling materials installed through 2021.

Material	Oahu	Maui	Hawaii	Kauai
	Residential Rooftop Mounted (kg)			
Copper	3.59E+05	8.27E+04	7.66E+04	1.87E+04
Aluminum	-	-	-	-
Commercial Rooftop Mounted (kg)				
Copper	2.67E+05	5.75E+04	3.95E+04	1.50E+04
Aluminum	-	-	-	-
Utility Ground Mounted (kg)				
Copper	1.33E+06	4.72E+04	0.00E+00	5.39E+05
Aluminum	6.92E+04	2.45E+03	0.00E+00	2.80E+04
Total	2.03E+06	1.90E+05	1.16E+05	6.01E+05



Energy Storage Systems

Photovoltaic energy storage penetration. Battery storage is a key energy technology supporting the deployment of photovoltaic power [87]. Data on residential and commercial storage installed through 2021 for the islands of O‘ahu, Maui County, and Hawai‘i County were obtained from Hawaiian Electric²² and from the U.S. Energy Information Agency for Kaua‘i²³. This obtained data combined the contributions of residential with commercial and does not allow for their differentiation. Utility-scale data for all islands was similarly pulled from the U.S. Energy Information Agency website²⁴. The results are plotted in Figure 15 and the raw data is provided in the Appendix (Table A11). Prior to 2015, solar PV was installed under net-metering agreements which de-incentivized the demand for energy storage. During this time, energy storage technology was not particularly available or affordable and with the exception of a few utility-scale projects in Maui County and modest amounts of energy storage were installed across all islands and scale. Post the termination of net metering agreements, the coupling of battery storage with PV solar installations increased rather sharply. In particular, the installation of storage surged at residential and commercial scale across all islands after 2017 while Kaua‘i saw a significant jump between 2016 and 2018 at utility-scale.

There are additional checks to this data. First, data on energy storage penetration for the island of Kaua‘i was acquired²⁵. This data is presented in Figure A4 for residential (A) and commercial (B). When compared against the data pulled from the IEA forms (Table A11), it is shown that numbers from IEA (Table 11) and KIUC (Figure A4) are within 98 percent. Finally, an additional

²² Data courtesy of Jason Mitchell, Hawaiian Electric.

²³ Data pulled from <https://www.eia.gov/electricity/data/eia861/>.

²⁴ Data pulled from <https://www.eia.gov/electricity/data/eia861/>.

²⁵ Data courtesy of Jonah Knapp, Kaua‘i Island Utility Cooperative.

check can be found with permit records for O‘ahu that similarly showed a sharp surge in the integration of storage with PV installations [88].

Figure 15. Cumulative PV solar installed storage through 2021. Legend: Residential and Commercial (A); Utility (B).

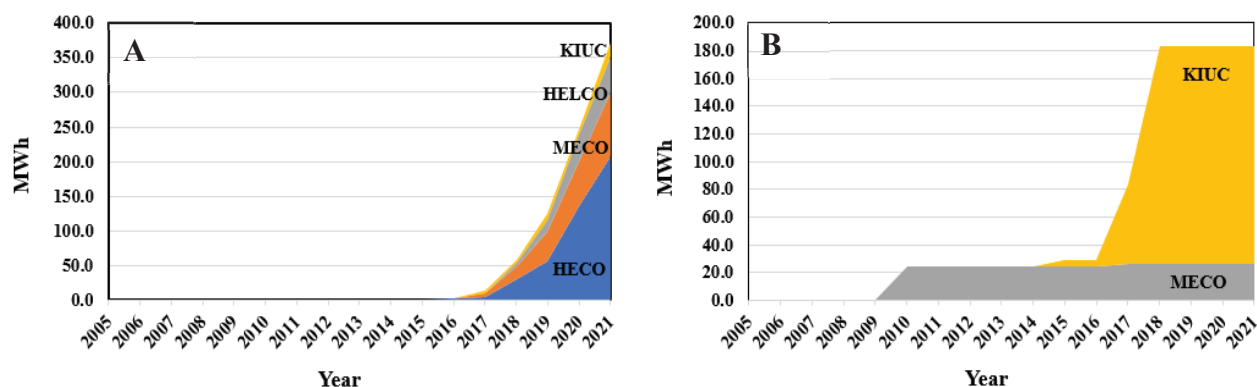

Electric vehicle energy storage penetration. Electric vehicles also contribute to battery waste stream flows [89]. Figure 16 presents three estimates of past, present, and future numbers of electric vehicles in the State of Hawai‘i [90]. This excludes hybrid vehicles, of which there are approximately 4,000 across Hawai‘i as of 2021 [90]. The data is presented in Figure 16 and the raw data is presented in the Appendix (Table A12). This data, which did not include Kaua‘i, was taken from studies published by HECO [91], the Hawai‘i Auto Dealers Association [92], and HNEI [93]. The State of Hawai‘i’s Department of Business, Economic Development and Tourism (DBEDT) has recently posted data on historical EV registrations for all islands [90]. This data matches well the data presented in the three studies through 2021. Because it does not provide future predictions, however, it was not included in Figure 16 or Table A12.

According to the EoT study, as of 2021, the State of Hawai‘i (excluding Kaua‘i) had approximately 15,628 electric vehicles: 11,345 on O‘ahu, 1,018 in Hawai‘i County, and 3,265 in Maui County (Figure 16) [92, 94]. As a check, these numbers are compared against current registrations reported by DBEDT. According to this report, as of 2021, the number of registered electric vehicles on O‘ahu, in Maui County, in Hawai‘i County, and on Kaua‘i were 13,930, 2,032, 1,243, and 530, respectively. Given that at the end 2021 the total number of EVs from the EoT study is within 90% of that reported in the DBEDT study, the value of 530 for Kaua‘i was taken as a reasonably accurate estimate for the number of EVs on Kaua‘i at the end of 2021. Moving forward, this data can be revisited as sources with more granular data are published²⁶ and estimates of future penetration on Kaua‘i are developed.

²⁶ The Hawai‘i State Energy Office is expected to publish its brand-new Data Lake in October 2022 which will include more granular Hawai‘i vehicle data along with a lot of other new energy and transportation databases.

As of 2021, the overall market share of electric vehicles relative to internal combustion vehicles remains low (Figure A5) [92]. This imbalance is expected, however, to change. For example, projections from the Hawai'i Auto Dealers Association suggest that by 2030, 33% of all new cars and trucks purchased in Hawai'i will be electric, with that number increasing to over 95% by 2045 (Figure A3) [92]. In fact, current predictions forecast that approximately 118,000 vehicles in Hawai'i will be electric by 2030 despite ongoing debate about the rate of acceptance (Figure 16B) [91]. Given the warranty lifetime of EV lithium-ion batteries is relatively short at 8 to 10 years²⁷, the impact of EV batteries to the total waste stream flow should begin by the late 2020's. Compared to the mainland, however, Hawai'i holds a small fraction of total electric vehicles in the U.S. By December 2020, the number of battery and plug-in hybrid electric vehicles in the U.S. had grown to nearly 1.7 million vehicles and by mid-2021, cumulative EV sales had surpassed 2 million [94]. As with the case for PV modules, this data suggests future guidance from the mainland can be anticipated.

²⁷ Based upon the common warranty period of 10 years.

Figure 16. Projected electric vehicle numbers through 2045. Legend: Across O‘ahu, Hawai‘i County, and Maui County per EoT study (A); aggregate totals across O‘ahu, Hawai‘i County, and Maui County per EoT, HADA, and HNEI studies (B) [91-93].

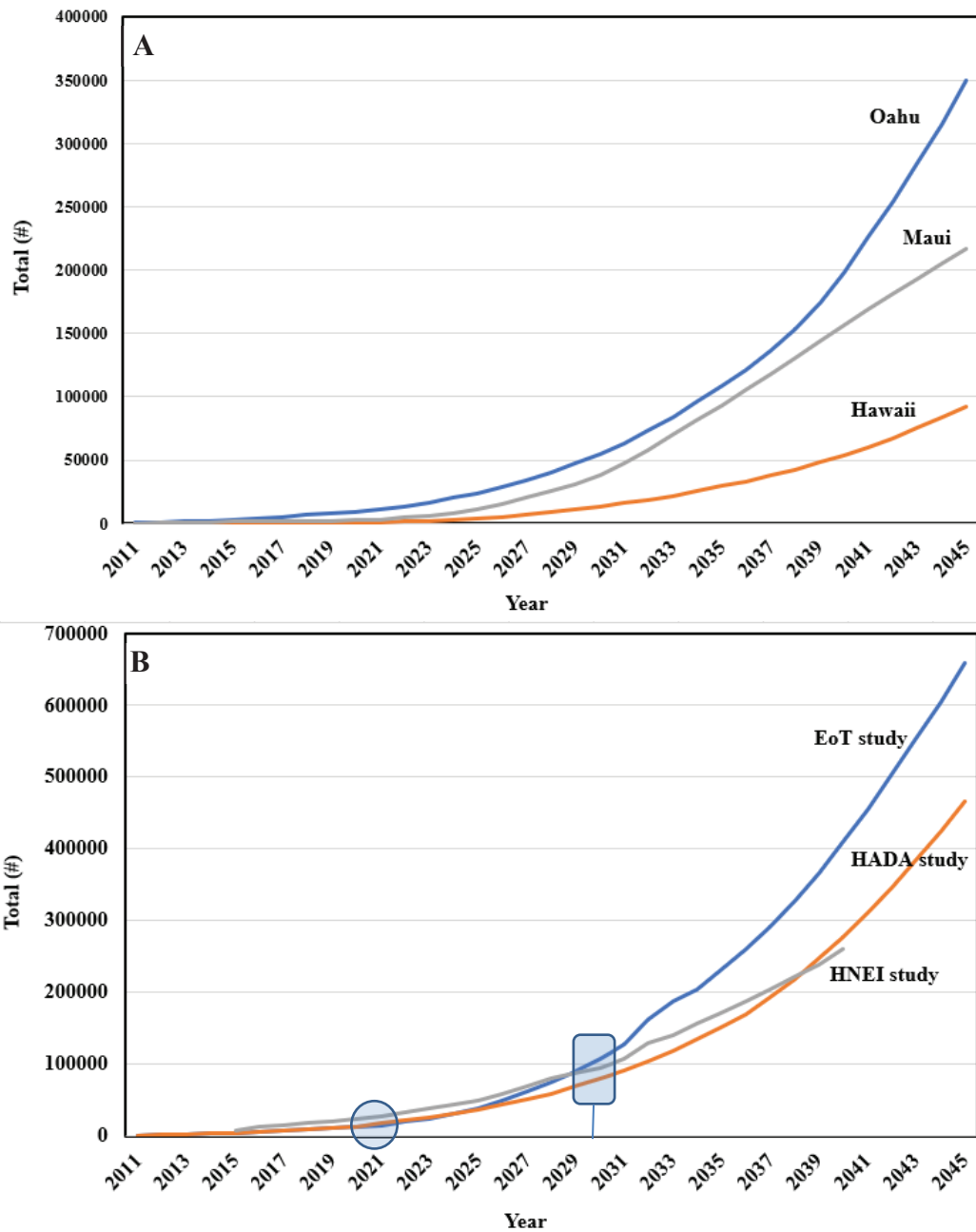

Energy storage – batteries. Batteries are contributed from electric vehicles and PV (residential, commercial, and utility-scale) energy storage. Assuming one battery per electric vehicle, the contribution from electric vehicles to the overall number of batteries on O‘ahu is shown Table 9. Numbers for energy storage batteries were calculated using an estimated value of 14 kWh per residential-scale installation (see Appendix, Communications C4), 100 kWh per commercial-scale installation [95], and 4 MWh per utility-scale installation [96]. The total number of energy storage system batteries installed through 2021 was estimated from the data in Figure 15 and Table A11. As of 2021, estimates suggest that there is a total of 15,628 batteries from electric vehicles, 15,320 from residential storage, 320 from commercial storage, and 46 in use at utility-scale. It is worth noting that in some cases (e.g., O‘ahu) the number of total estimated batteries from EV actually outnumber batteries from energy storage systems at all scales.

Table 9. Estimated cumulative number of batteries per island through 2021.

Battery Source	Unit	Oahu	Hawaii	Maui	Kauai	Total
EV Storage	#	11345	1018	3265	530	15628
Residential Storage	#	8377	4047	2412	483	15320
Commercial Storage	#	175	85	50	10	320
Utility Storage	#	0	0	7	39	46

Energy storage – ancillary components. The ancillary components to batteries will vary with their application in BESS or EV frameworks. For example, EV packs will possess a housing, battery management systems (BMS), cooling system, and insulation. Grid storage systems will similarly possess a housing and battery management system, but will also possess an inverter and fire suppressant system and typically will not use insulation.

For EV packs, the mass amounts of each ancillary component will be estimated using Equation 3,

$$Amount (kg) = 28 \frac{kWh}{car} \times cars (\#) \times material \frac{kg}{kWh} \quad (3)$$

where the number of cars is taken from the EoT study (Figure 16A, raw data presented in Table A12), the averaged value of storage (kWh) per car battery type is assumed to be 28 kWh per car (Table 3), and the material (kg per kWh) for each component is taken from Table 4.

With respect to grid scale, the amounts of each ancillary component can be estimated using Equation 4,

$$\text{Amount (kg)} = \text{Cumulative installed storage (MWh)} \times \text{material} \frac{\text{kg}}{\text{kWh}} \times 1000 \frac{\text{kWh}}{\text{MWh}} \quad (4)$$

where the cumulative installed PV (MWh) is taken from Table A11 and the material (as kg per kWh) for each component is taken from Table 4. Using these values, the cumulative amounts through 2021, across O‘ahu, Maui County, and Hawai‘i County, are presented in Table 10.

Table 10. Predicted cumulative amounts of battery ancillary components across all scales as a function of island for electric vehicles (EV Packs) and energy storage systems (Grid Storage) through 2021.

System component	Material	unit	EV packs				Grid Storage			
			Oahu	Maui	Hawaii	Kauai	Oahu	Maui	Hawaii	Kauai
Housing	Steel or Aluminum ¹	kg	1.43E+05	4.11E+04	1.28E+04	6.68E+03	4.15E+05	1.57E+05	1.83E+05	3.54E+05
	Plastics	kg	3.18E+04	9.14E+03	2.85E+03	1.48E+03	-	-	-	-
BMS	Electronics	kg	1.59E+03	4.57E+02	1.43E+02	7.42E+01	2.08E+03	7.87E+02	9.17E+02	1.77E+03
Inverter	System	kg	-	-	-	-	5.81E+04	2.20E+04	2.57E+04	4.96E+04
Cooling System	System	kg	-	-	-	-	2.28E+04	8.66E+03	1.01E+04	1.95E+04
	Coolant	kg	1.91E+04	5.49E+03	1.71E+03	8.90E+02	-	-	-	-
Insulation	Fiberglass	kg	6.35E+03	1.83E+03	5.70E+02	2.97E+02	-	-	-	-
Fire Suppression	Steel	kg	-	-	-	-	1.25E+04	4.72E+03	5.50E+03	1.06E+04
	Fire Suppressant	kg	-	-	-	-	4.15E+03	1.57E+03	1.83E+03	3.54E+03

These numbers will vary with the uncertainty of the underlying estimates. That said, the results suggest that there is approximately 143,000 kg of aluminum or steel associated with the housing units of EV vehicles on the island of O‘ahu. For context, if we assume an average weight of 8,360 kg per EV vehicle, the amount of aluminum or steel contained in the housing of EV vehicles currently on O‘ahu is equivalent to the weight of approximately 17 EV vehicles. Moreover, the amount of steel contained in the ancillary components of grid energy storage systems is roughly three times that amount. In aggregate, these values suggest that the amount of overall steel currently contained in the housing of both EV and grid-connected storage is low and manageable (i.e., compared to routine amounts of steel or aluminum recycled on O‘ahu). Similar trends are observed for the remaining materials.

Solar Hot Water Systems

Quantitative data on solar hot water system is not tracked by any central source and is not available. That said, Hawai‘i has one of the most successful solar water heating programs in the country. Although not dominant, the market penetration of solar water heaters in Hawai‘i is impressive. To date, about one in four single-family homes in Hawai‘i use solar water heaters, with some estimates

suggesting 90,000 residential solar water heating systems are in operation in Hawaiian Electric service territories [1]. Moreover, in order to further promote the use of solar water heaters, in 2010, the Hawai‘i state legislature mandated the installation in all new homes [97].

Future Penetration 2022 Through 2045

Photovoltaic penetration. At the time of this report, data on the future penetration of residential, commercial, and utility-scale PV (in MW) *post* 2021 was somewhat incomplete. Specifically, at the time of this report, data on installed PV for the final quarter of 2022 had yet to be posted on HECO’s website *Quarterly Installed Solar Data* [80]. HECO’s integrated grid report, however, provided estimates of residential and commercial PV to be installed on the islands of O‘ahu, Maui County, and Hawai‘i County through 2045 [91]. KIUC provided estimates for Kaua‘i²⁸. Projected Utility-scale data was available through 2025; a number of purchase power agreements (PPA) for utility-scale solar projects have, in recent years, been negotiated [98]. While a few of the listed utility projects have been approved, the majority remain under permit review, engineering design, financing, and development. Others may have been cancelled due to ongoing supply chain issues which were prominent at the time of this report.

The projected future residential plus commercial penetration between 2022 and 2045 is presented in Figure 17 while the estimated utility-scale penetration through 2025 is presented in Figure 18. The raw data is presented in the Appendix (Table A13) along with a snapshot of HECO’s project status board for projects on O‘ahu, Maui County and Hawai‘i County (Table A14) [98]. When completed, these combined residential and commercial projects are projected to add an additional 428.8 MW_{ac} of PV production to O‘ahu, 111.4 MW_{ac} in Hawai‘i County, 109.8 MW_{ac} in Maui County and 49.9 MW_{ac} on Kaua‘i. The additional amounts predicted to be installed at utility-scale are 418.5 MW_{ac} on O‘ahu, 72 MW_{ac} in Hawai‘i County, 192.4 MW_{ac} in Maui County, and 35.7 MW_{ac} on Kaua‘i.

The aggregate amounts predicted to be installed at residential and commercial scale are lower than the amounts that have already been installed. At the end of 2021, the cumulative installed residential and commercial PV on O‘ahu was 625 MW (Table A9) while the additional amount estimated to be installed between 2022 and 2045 totaled 428 MW, yielding a cumulative installed amount of approximately 1,053 MW (Table A13). While this represents an additional 40% to be added over the next twenty-four years, it actually amounts to just 1.7 % per year.

A representative utility project schematic scaled to 1MW AC is shown in the Figure 19. The project size of each is shown is the nameplate capacity of the project, specified by the maximum output of the inverters. The DC-PV portion of these projects is typically 30-40% above the AC rating and each has approximately 4 hours of storage, again based on the inverter rating.

²⁸ Data courtesy of Jonah Knapp, Kaua‘i Island Utility Cooperative.

Figure 17. Predicted cumulative penetration of residential plus commercial PV installation through 2045 as a function of island. Intercepts at 2022 reflect the amount of cumulative installed PV as of the end of 2021.

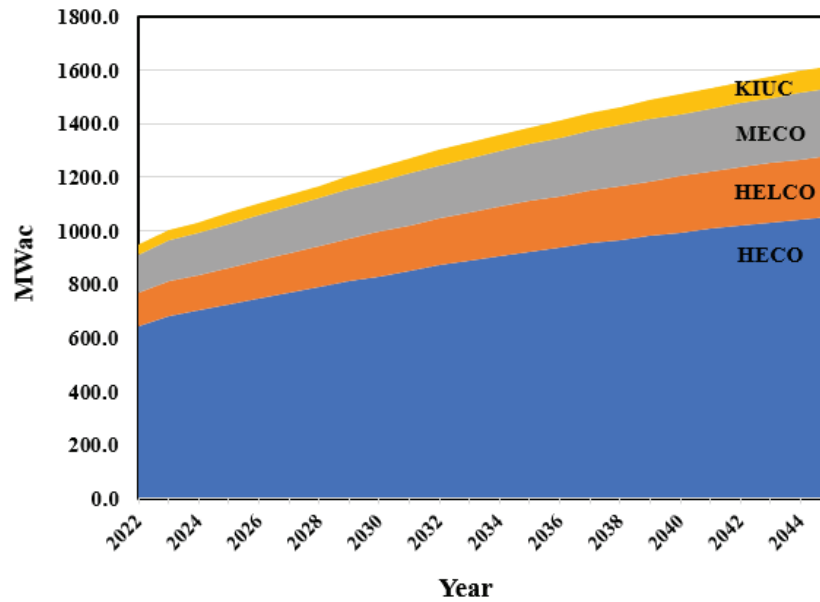

Figure 18. Predicted cumulative penetration of utility-scale PV installation through 2025 as a function of island. Intercepts at 2022 reflect the total amount of installed PV as of the end of 2021.

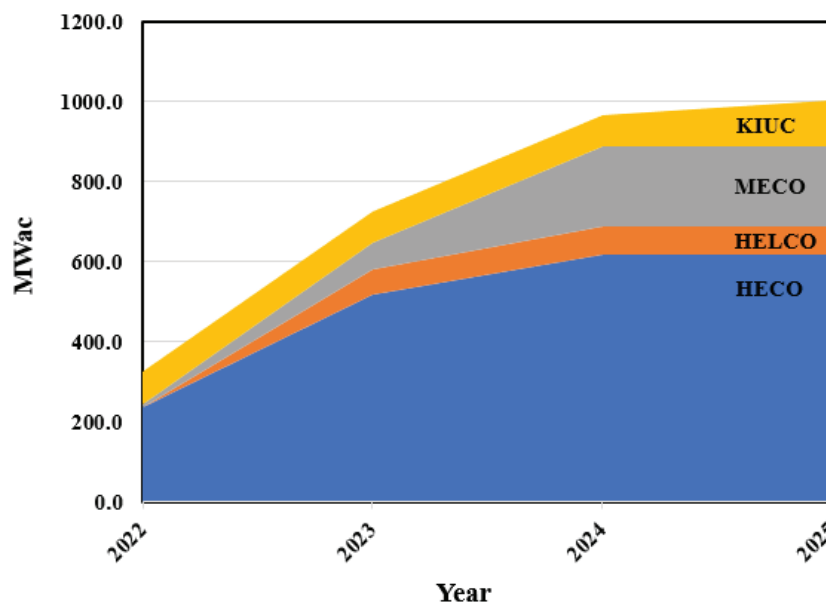
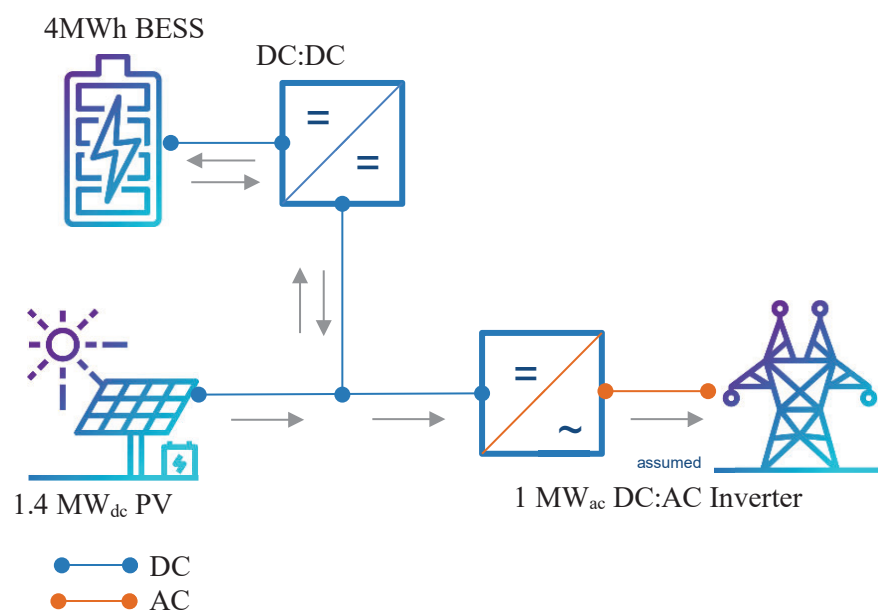

Figure 19. Representative schematic of Hawaiian Electric utility-scale PPA.



Photovoltaic modules. Table 11 presents the total number of *new* modules estimated to be installed between 2022 and 2045 along with the *total* number of PV modules projected to be installed through 2045. A DC/AC loss factor of 1.4 was assumed in these calculations. Using the same assumptions that were used to estimate the number of PV modules installed through 2021 (Table 5), a total of 7.69 million PV modules total are expected to be installed on O‘ahu by 2045, 1.53 million in Maui County, 1.93 million in Hawai‘i County, and around 877,000 on Kaua‘i. The estimates for Kaua‘i are only estimates; the future penetration of PV penetration, for example, are based on linear extrapolations of past penetration and the utility penetration is assuming a 50 MW_{dc} project goes through. For all islands, these numbers translate to the addition of approximately 3.83 million new (i.e., between 2022 and 2045) modules on O‘ahu, 1.34 million in Hawai‘i County, 807,000 in Maui County, and 393,000 on Kaua‘i (Table 11).

Table 11. Total cumulative number of PV modules projected to be installed, as a function of scale and island, by 2045 (A), and total number of new modules to be installed between 2022 and 2045 (B) [79].

A	Scale	Island			
		Oahu	Maui	Hawaii	Kauai
	Residential & Commercial	5.23E+06	1.24E+06	1.13E+06	4.14E+05
	Utility	2.46E+06	2.88E+05	7.98E+05	4.63E+05
	Total	7.69E+06	1.53E+06	1.93E+06	8.77E+05

B	Scale	Island			
		Oahu	Maui	Hawaii	Kauai
	Residential & Commercial	2.15E+06	5.47E+05	5.42E+05	2.50E+05
	Utility	1.67E+06	2.60E+05	7.98E+05	1.43E+05
	Total	3.83E+06	8.07E+05	1.34E+06	3.93E+05

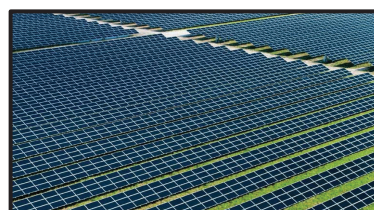

The predicted numbers of *new* modules to be installed between 2022 and 2045 should be taken in context, as these estimates assume the additional penetration of MW_{ac} will be produced by PV systems. However, it is equally possible that a fraction of this future penetration (especially at utility-scale) will come from other renewable systems such as large-scale biomass, geothermal, hydroelectric, or wind farms. Given that these systems will generate substantially different waste streams, the usefulness of using predictions of future penetration post-2021 as a basis to estimate disposal loading rates is questionable. As such, it is recommended to update these numbers.

Photovoltaic energy storage penetration. Estimates of future photovoltaic energy storage are presented in Figure 20 for residential plus commercial-scale (Figure 20A) and utility-scale (Figure 20B). The raw data is presented in Table A15. The predicted storage for residential plus commercial on O‘ahu and in Hawai‘i and Maui County is taken from HECO’s integrated grid report [91]. The aggregate residential plus commercial projections for Kaua‘i were estimated by taking the sum of the slopes of a linear extrapolation of the installed residential and commercial data on Kaua‘i presented in Figure A4²⁹. At utility-scale, projected energy storage on O‘ahu and in Hawai‘i and Maui County for the years 2022 through 2025 was taken from the project status boards of Hawaiian Electric [98]. Data for Kaua‘i at utility-scale was taken from data provided by KIUC³⁰. These data only included a summary of storage capacity for all approved and “under review” utility-scale projects for the years between 2022 and 2025. The energy storage associated with those projects totals approximately 3,665 MWh of additional battery energy storage, orders of magnitude more than that currently deployed. That being said, similar to the projections of PV

²⁹ Data courtesy of Jonah Knapp, Kaua‘i Island Utility Cooperative.

³⁰ Data courtesy of Jonah Knapp, Kaua‘i Island Utility Cooperative.

penetration, these numbers are fluid estimates and should be updated before making projections of battery disposal rates (from these systems).

Figure 20. Predicted PV solar installed storage through 2045. Legend: Residential plus commercial (A); Utility (B). Intercepts at 2022 reflect the total amount of installed PV as of the end of 2021.

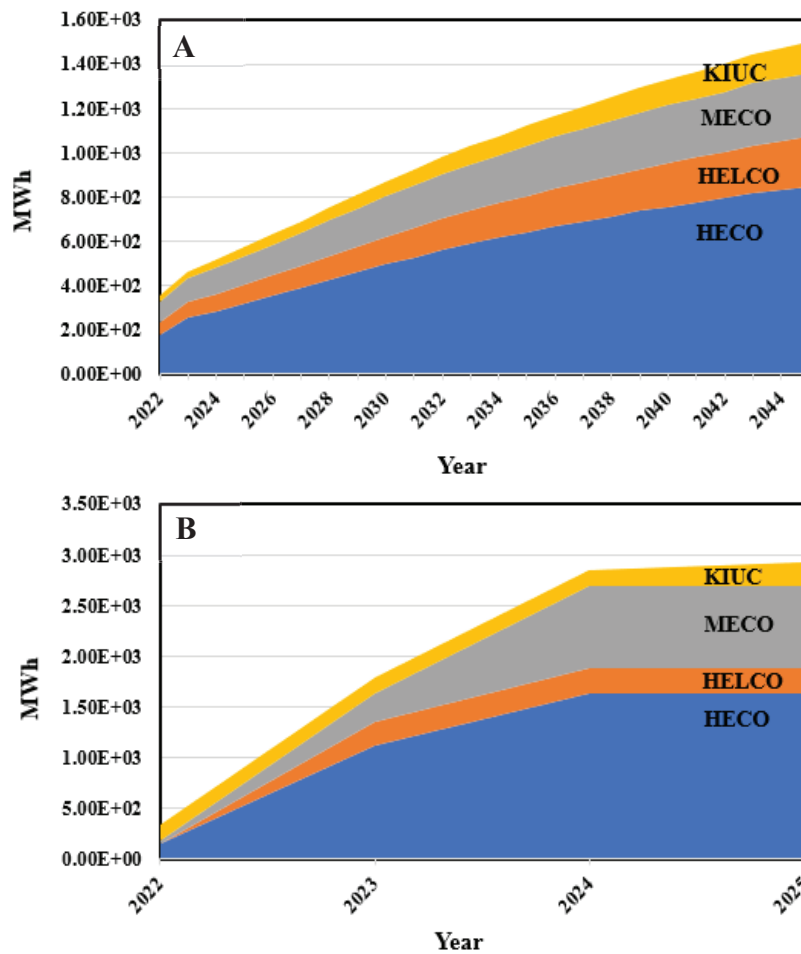

Electric vehicle energy storage penetration. The projection of future electric vehicle penetration was previously presented in Figure 16. These projections show a dramatic increase in the number of EVs (and their batteries), reaching over 600,000 by 2045. As with the projections of photovoltaic and photovoltaic energy penetration, these predictions are fluid and based on a range of assumptions. Similarly, using these projections to predict disposal loading rates is discouraged and should be revisited.

QUANTITY AND TIMING OF DISPOSAL LOADING RATES

This section uses the information from Sections 1 and 2, along with estimates of projected lifetimes of the various components, to estimate the timing and quantity of disposal loading rates. **Disposal estimates are limited to clean energy materials installed through 2021.** There are several reasons for this. First, due to the relatively long-life time of these materials, along with the expected evolution of additional refurbish and reuse pathways, clean energy materials installed after 2021 will not likely enter waste streams until after 2030, at which point in time the disposal and recycling pathways will differ from those pathways available today. Second, because of ongoing advances in technology, the materials to be installed will further evolve in terms of chemical composition and expected lifetime. Third, many of these evolved materials will be increasingly designed to support more efficient reuse and recycling. As such, not only will best practices for the collection, disposal, and recycling evolve, but so will the timing of their disposal. The benefit of attempting to predict the time disposal loadings for clean energy materials to be installed post-2021 is questionable. Rather, it would more effective to revisit this prediction at a later date and after further data collection as recommended in this report.

Photovoltaic Systems

Photovoltaic modules. PV modules are generally proposed to have a useful lifespan of approximately twenty-five years [12, 20], with module degradation rates of no more than 12% over 25 years for modules produced after 2000 [99]. This does not always equate, however, to time to disposal. PV modules can fail or degrade at faster rates (1-2% per year) due to several factors [100-102]. For example, degradation of EVA (Ethylene-vinyl acetate), the widely used encapsulant in the PV modules, will reduce the performance of PV modules [101]. Also, enhanced degradation and electromigration can occur within contact layers and interconnects. The deterioration of contact layer can increase the series resistance value whereas the deterioration of interconnect may influence both the series and shunt resistance. These degradation rates, when measured under field conditions, often contradict the warranty provided by manufacturers [100].

Other factors that can impact the moment PV modules are disposed. In Hawai'i, for example, most of the early net metering agreements will become void if the originally installed PV modules are replaced. This may limit their replacement until there is *significant* malfunction. Also, residential homeowners in general may be hesitant to replace modules simply because of cost. By contrast, there is more incentive for commercial and utility-scale installations to replace modules with increasingly more powerful and less expensive modules [103]. Replacing old modules – even today's long-lived commercial modules – with more efficient and reliable new modules can significantly upgrade a system's peak capacity [103]. The economics of this strategy benefits from technological progress, which makes modules increasingly affordable, efficient, and reliable. According to the U.S. Energy Information Administration, the average value of PV modules

shipped in 2019 (the most recent year for which data is available) was 41 cents per watt of electricity generated at peak performance [104]. A decade earlier, the average was \$2.79 per peak watt (Figure 21). Moreover, many commercial and utility-scale installations can operate under contracts that require a set power production rate which further pressures the early replacement of modules. These trends can be expected to continue.

Figure 21. The average value of photovoltaic modules, 2006-2020 (dollars per peak Watt).

Year	Modules
2006	\$3.50
2007	\$3.37
2008	\$3.49
2009	\$2.79
2010	\$1.96
2011	\$1.59
2012	\$1.15
2013	\$0.75
2014	\$0.87
2015	\$0.71
2016	\$0.72
2017	\$0.48
2018	\$0.45
2019	\$0.41
2020	\$0.38

To account for these considerations, our analysis has assumed an averaged 20-year lifetime for PV modules at all scales³¹. Using this assumption, a prediction of disposal rates has been created for residential, commercial, and utility-scale using the values of module composition (Figure 2, Table A1) and PV penetration (Figure 14, Table A9). The results are presented as a function of island (Figures 22 through 25 for residential scale; Figures 26 through 29 for commercial scale; and Figures 30 through 32 for utility-scale). Also shown (inset) is the total material loading and number of modules that will be disposed as a function of island and year. The figure for the Hawai'i County is excluded because at the time of this report no recorded utility-scale installations had been installed in Hawai'i County before 2021. The data for each figure is presented in the Appendix (Tables A16 through A19 for residential; Tables A20 through A23 for commercial; and Tables A24 through A27 for utility).

³¹ This assumption made for uniformity of projects despite the fact that some utility scale projects are now beginning to be contracted for 15 years.

When broken down across island and scale, there are some trends worth noting. The dominant materials being disposed of are glass, aluminum (largely from the frame), EVA polymer, silicon, and backing material (PVF/PET), followed by an assortment of metals including zinc (Zn), nickel (Ni), silver (Ag), tin (Sn), lead (Pb), and copper (Cu). Another key trend is that the amounts being disposed of, across all islands at residential and commercial scale, are generally low through 2030, thereafter increasing sharply until reaching maximums around the years 2033 through 2035.

The amounts being disposed of can be substantial. On O'ahu, for example, in 2033, the total amount of material disposed of is 320,000 modules weighing approximately 6.8 million kg of which copper contributes 46,000 kg, lead contributes 3,360 kg, tin contributes 3,160 kg, silver contributes 14,500 kg, and nickel contributes 64 kg (Table A16). Taken in isolation, these numbers appear reasonable but when added up year after year they can accumulate to levels that justify decisions to ban their future landfill. Moreover, these values also ignore contributions from commercial and utility-scale modules although it should be noted that the "utility-scale" PV modules may not enter the waste stream if the utility-scale installations operate under power purchase agreements (PPAs) that require the operator to take full responsibility for off-island disposal of their modules. It is recommended to review these agreements for the specificity of these details in a separate report.

The aggregate disposal loading rates can also be tallied. Figure 33 plots the aggregated disposal loading rates across all islands and scales. The data for Figure 33 is given in the Appendix (Table A28) along with aggregated data for each island (Tables A29 through A32). Similar to the disposal loading rates for each island and scale, aggregated disposal loads begin to surge dramatically around 2030 until leveling off in 2033. In that year, the aggregate amount of module material predicted to be disposed totals 575,000 thousand modules weighing approximately 12.4 million kg of which copper contributes 83,800 kg; lead contributes 6,030 kg; tin contributes 5,680 kg; silver contributes 26,100 kg; and nickel contributes 649 kg.

Finally, although similar projections can be made for PV modules installed after 2021, these calculations were not considered in this report because the first (of them) will not enter the waste stream until 2040 or thereafter and, as has been previously discussed, the module compositions could be much different as will their reuse and recycling pathways. Accordingly, the following figures go through 2040 only. For the aforementioned reasons, it is recommended to revisit these predications.

Figure 22. Predicted disposal rates of materials from residential PV modules on O'ahu. Inset: Total amount of material mass (blue dotted line) and estimated number of PV modules (red solid line).

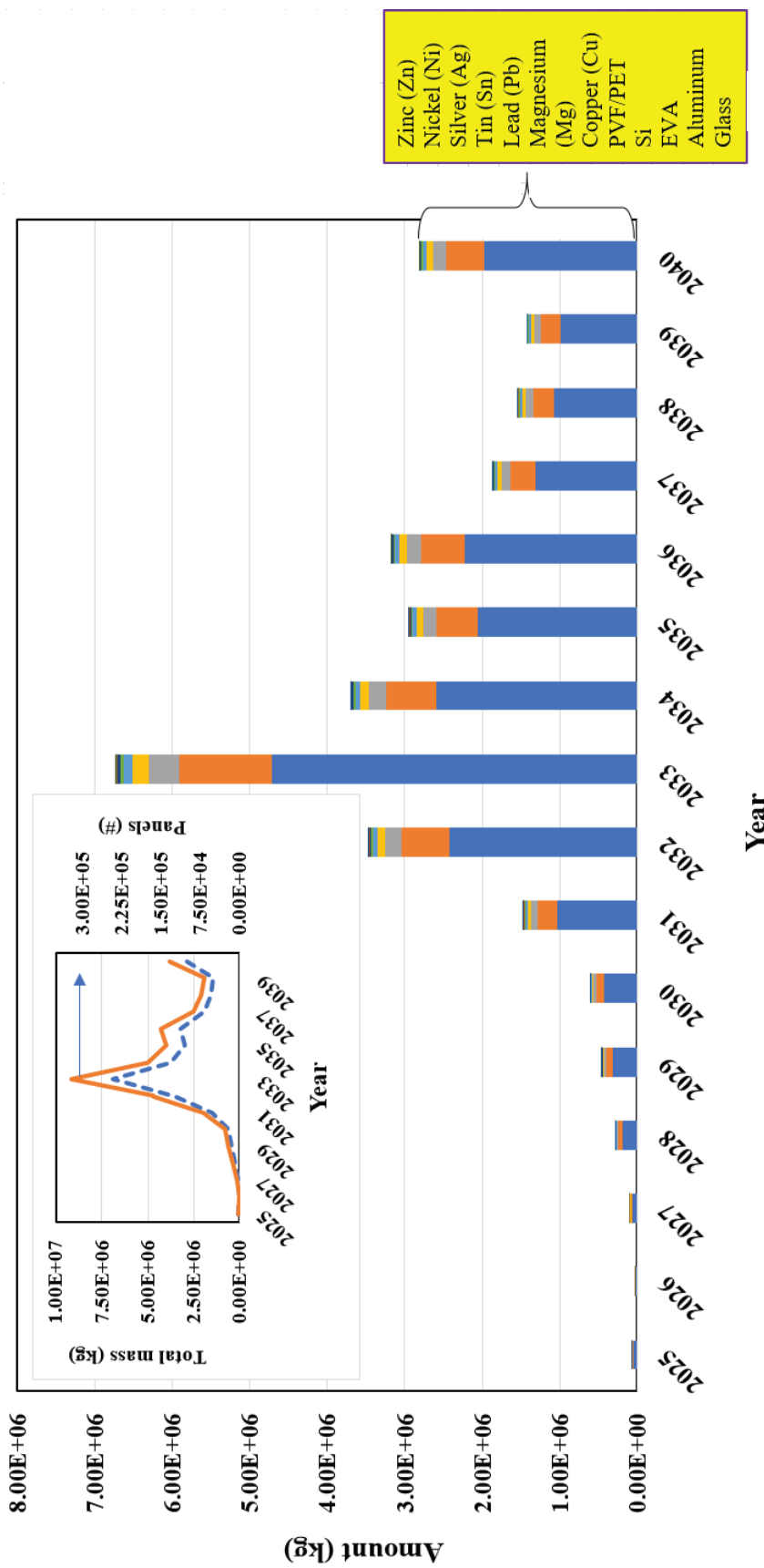

Figure 23. Predicted disposal rates of materials from residential PV modules in Hawai'i County. Inset: Total amount of material load (blue dotted line) and estimated number of PV modules (red solid line).

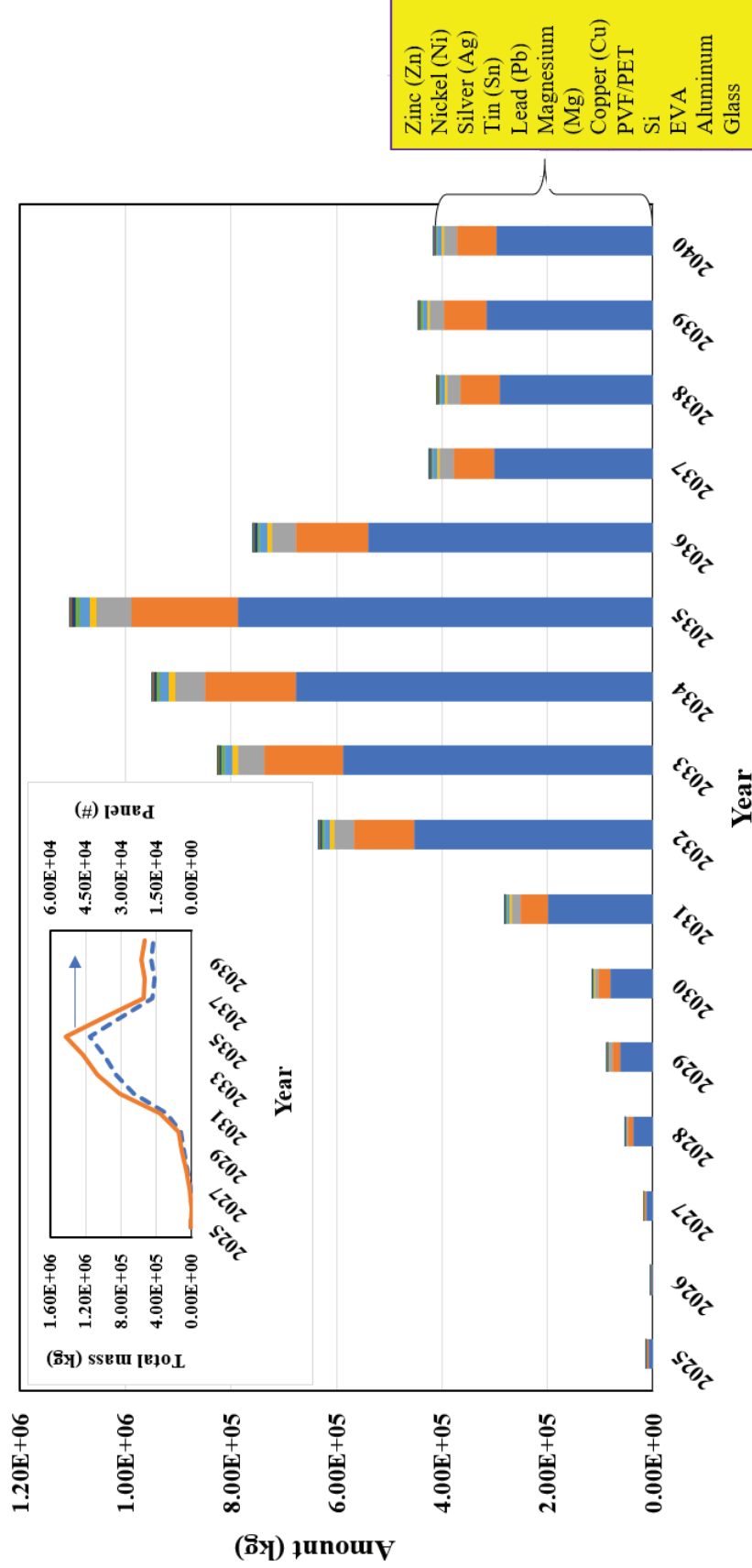

Figure 24. Predicted disposal rates of materials from residential PV modules in Maui County. Inset: Total amount of material load (blue dotted line) and estimated number of PV modules (red solid line).

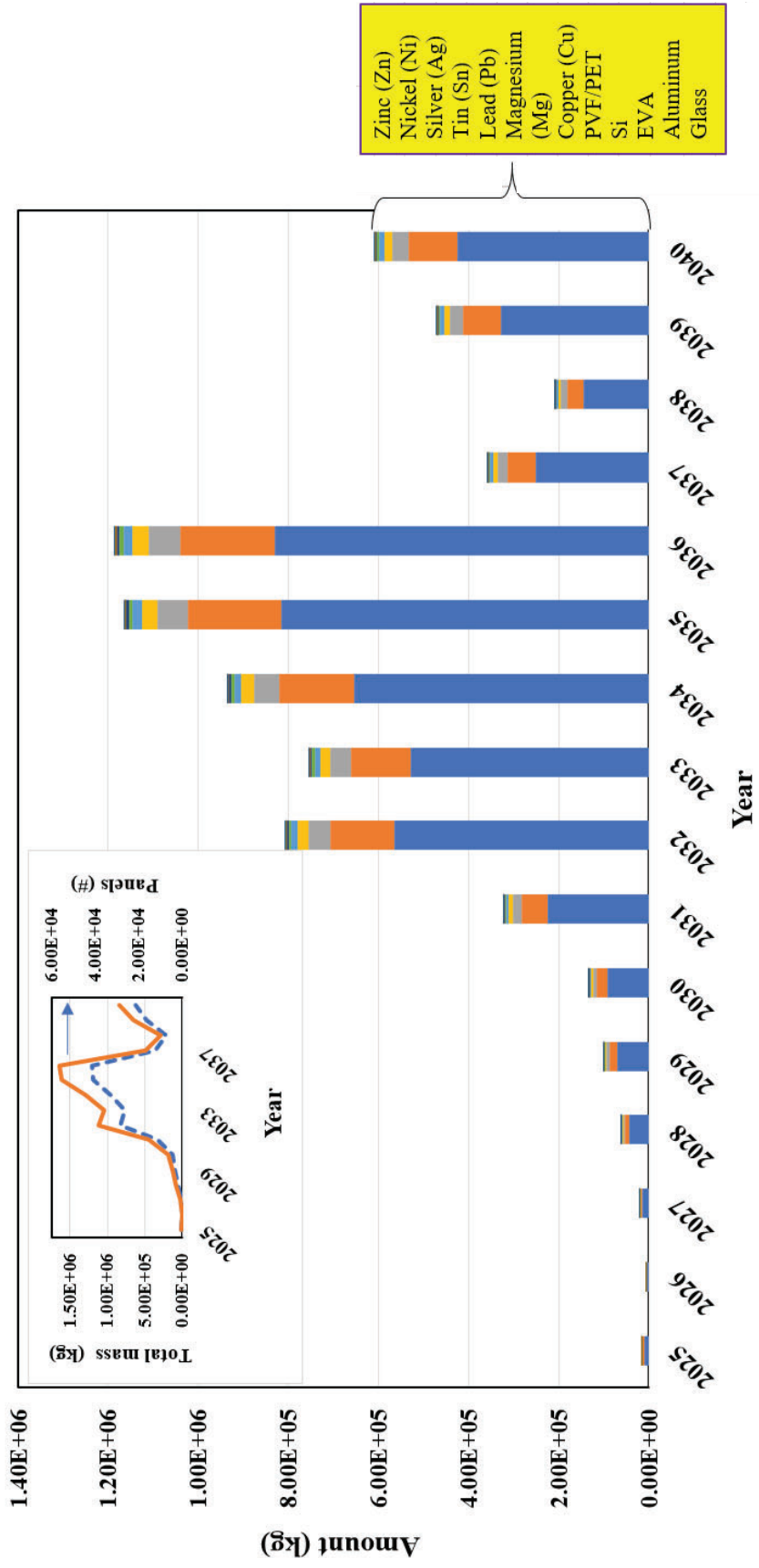

Figure 25. Predicted disposal rates of materials from residential PV modules on Kaua'i. Inset: Total amount of material load (blue dotted line) and estimated number of PV modules (red solid line).

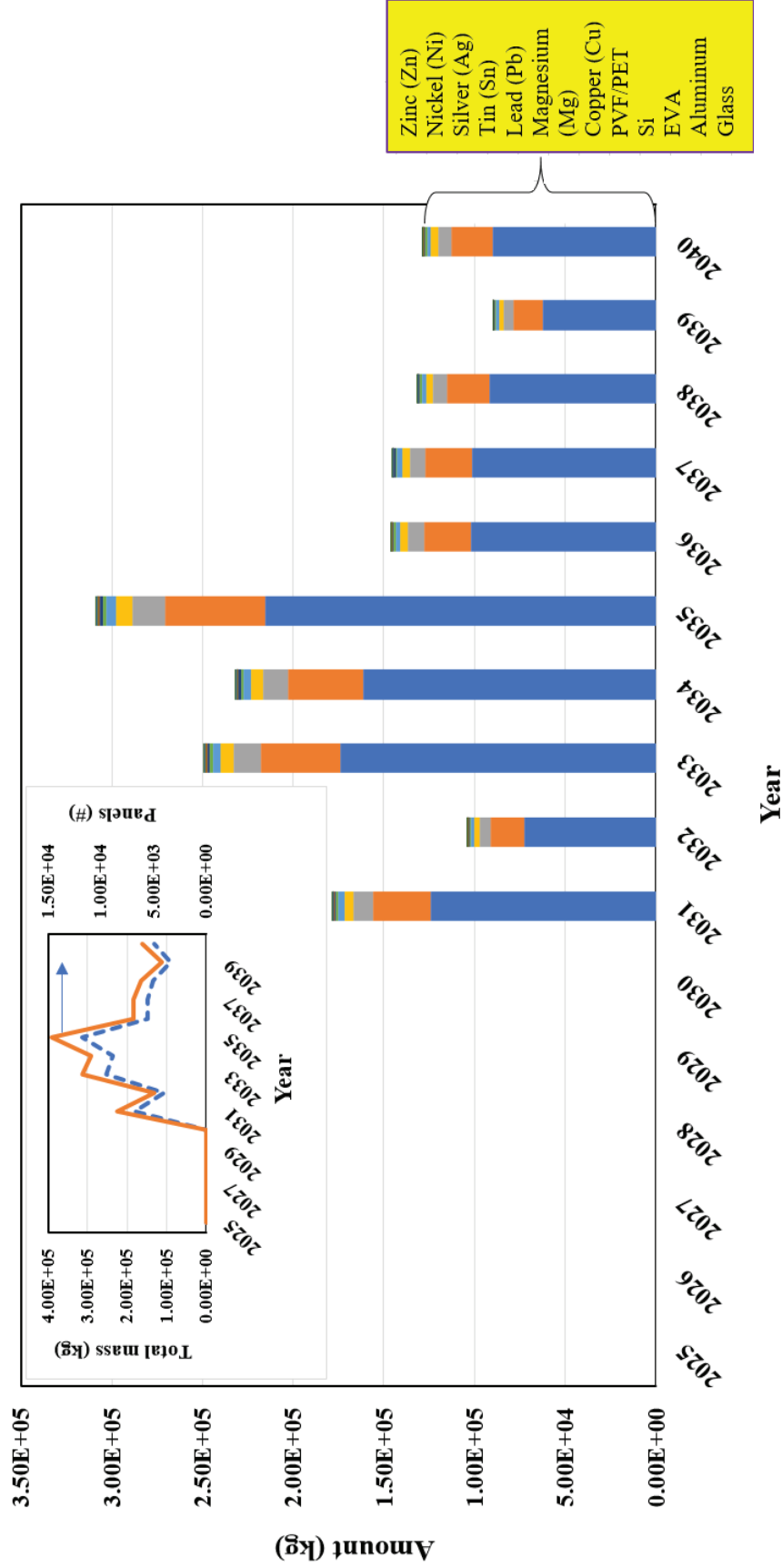

Figure 26. Predicted disposal rates of materials from commercial PV modules on O'ahu. Inset: Total amount of material load (blue dotted line) and estimated number of PV modules (red solid line).

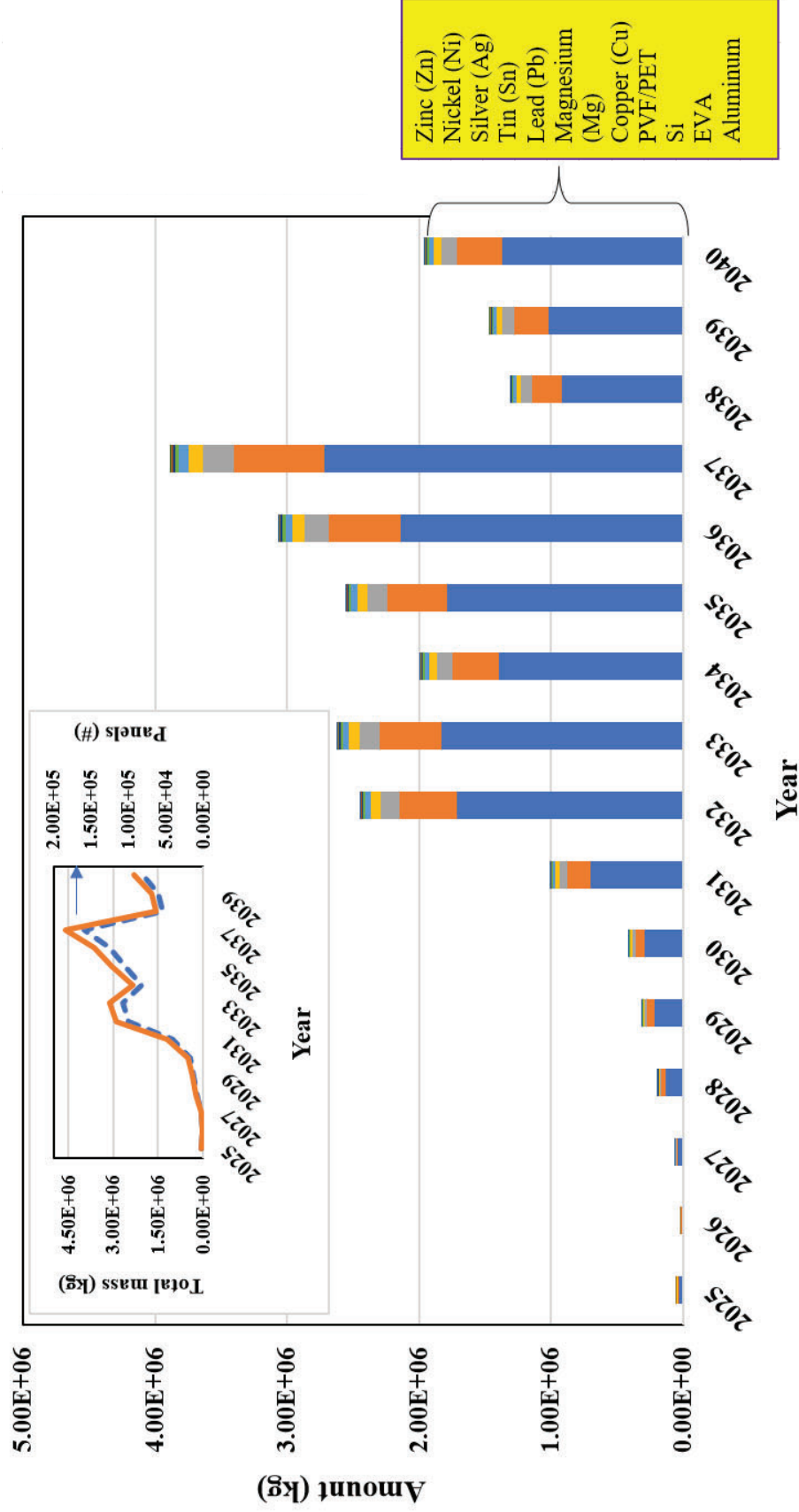

Figure 27. Predicted disposal rates of materials from commercial PV modules in Hawai'i County. Inset: Total amount of material load (blue dotted line) and estimated number of PV modules (red solid line).

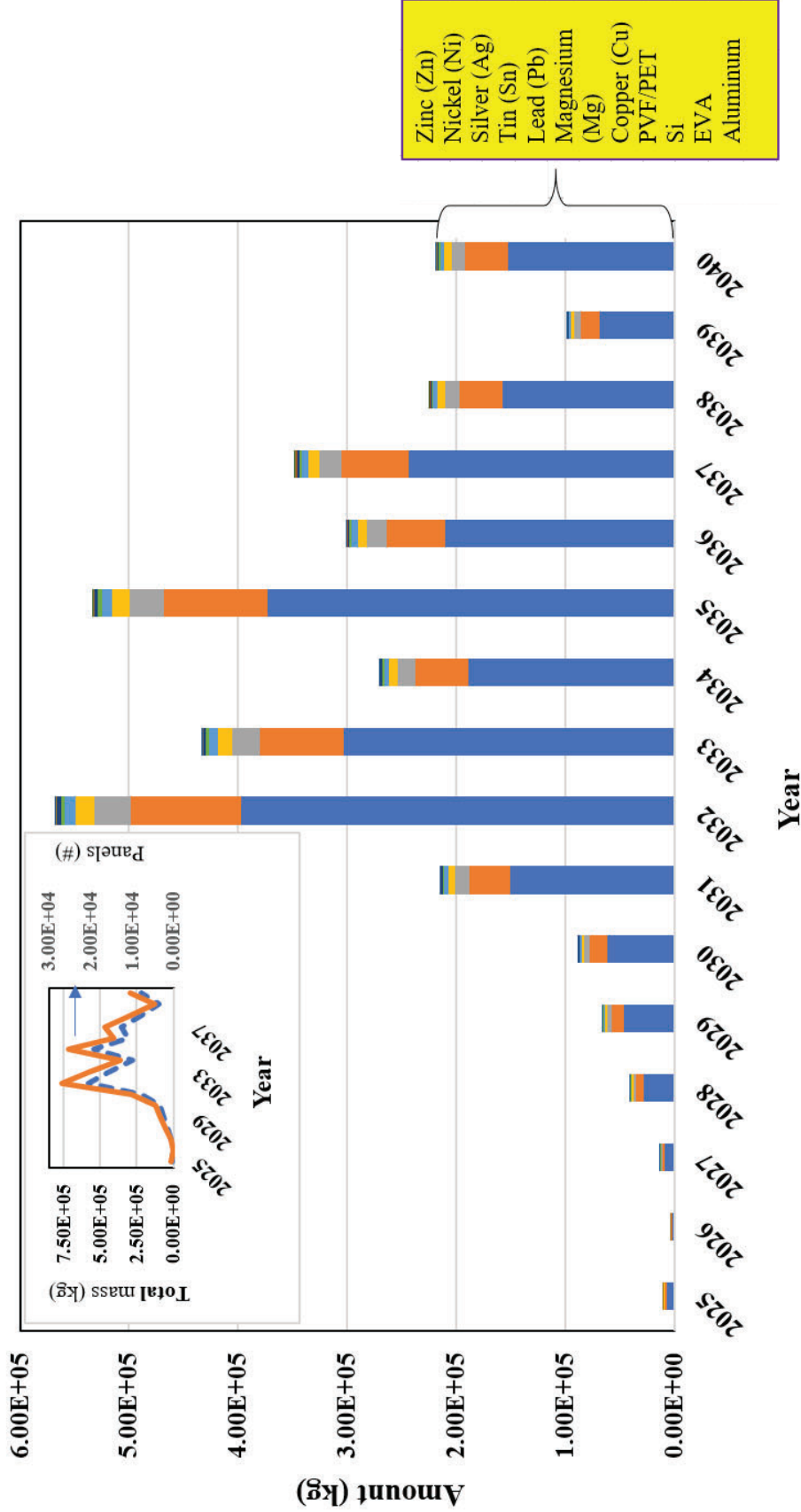

Figure 28. Predicted disposal rates of materials from commercial PV modules in Maui County. Inset: Total amount of material load (blue dotted line) and estimated number of PV modules (red solid line).

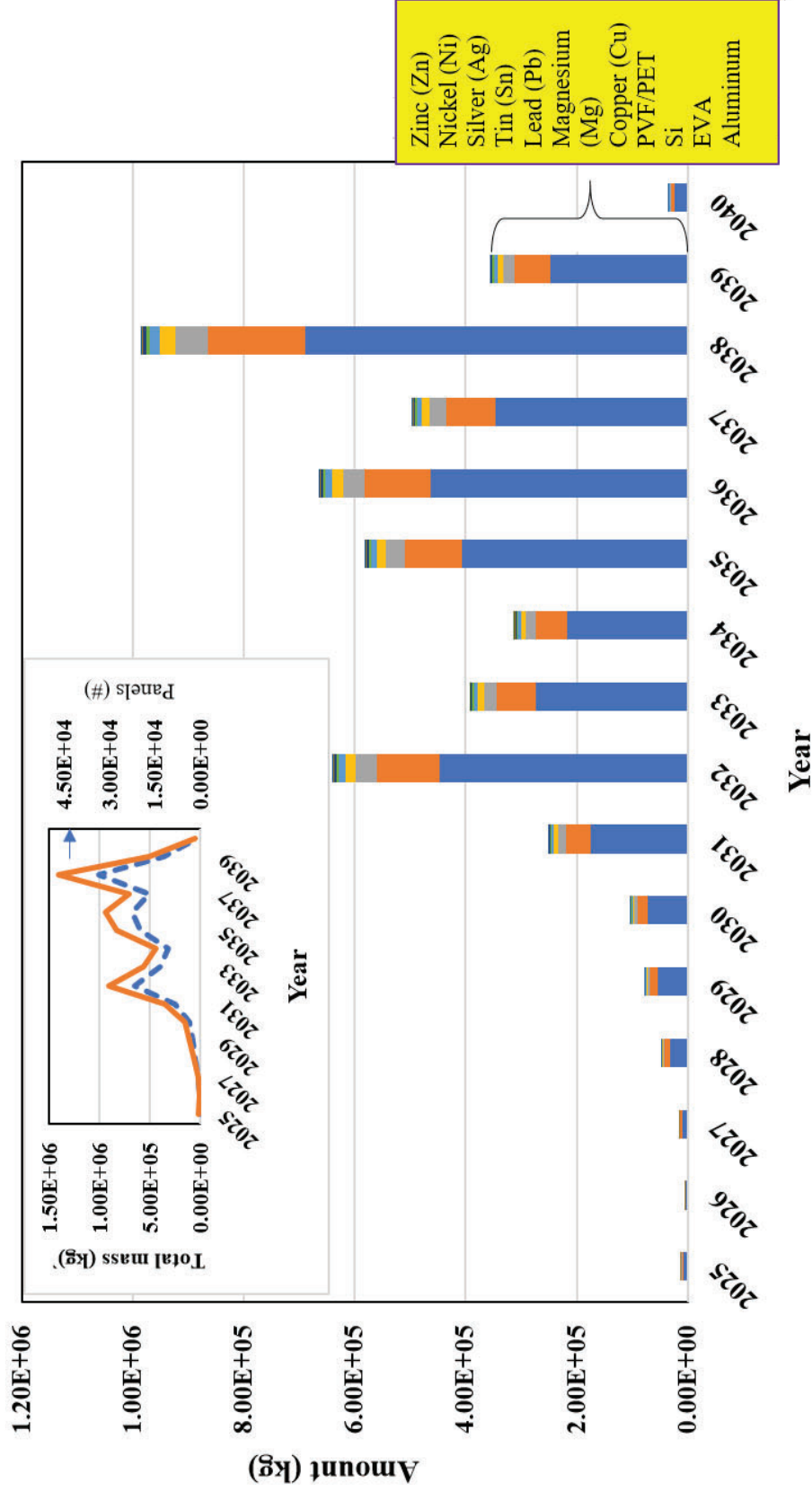

Figure 29. Predicted disposal rates of materials from commercial PV modules on Kaua'i. Inset: Total amount of material load (blue dotted line) and estimated number of PV modules (red solid line).

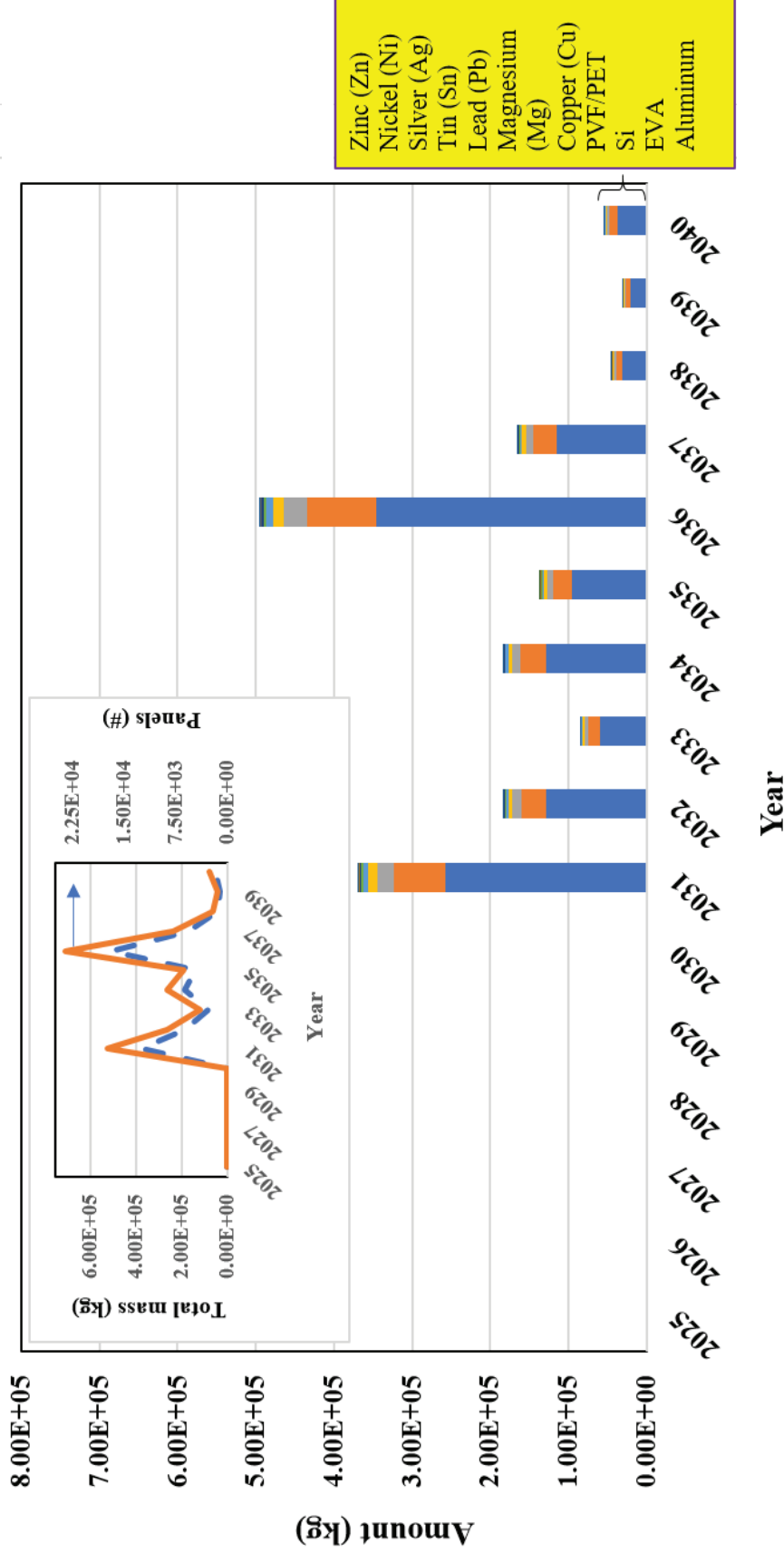

Figure 30. Predicted disposal rates of materials from utility PV modules on O'ahu. Inset: Total amount of material load (blue dotted line) and estimated number of PV modules (red solid line) (blue dotted line) and estimated number of PV modules (red solid line).

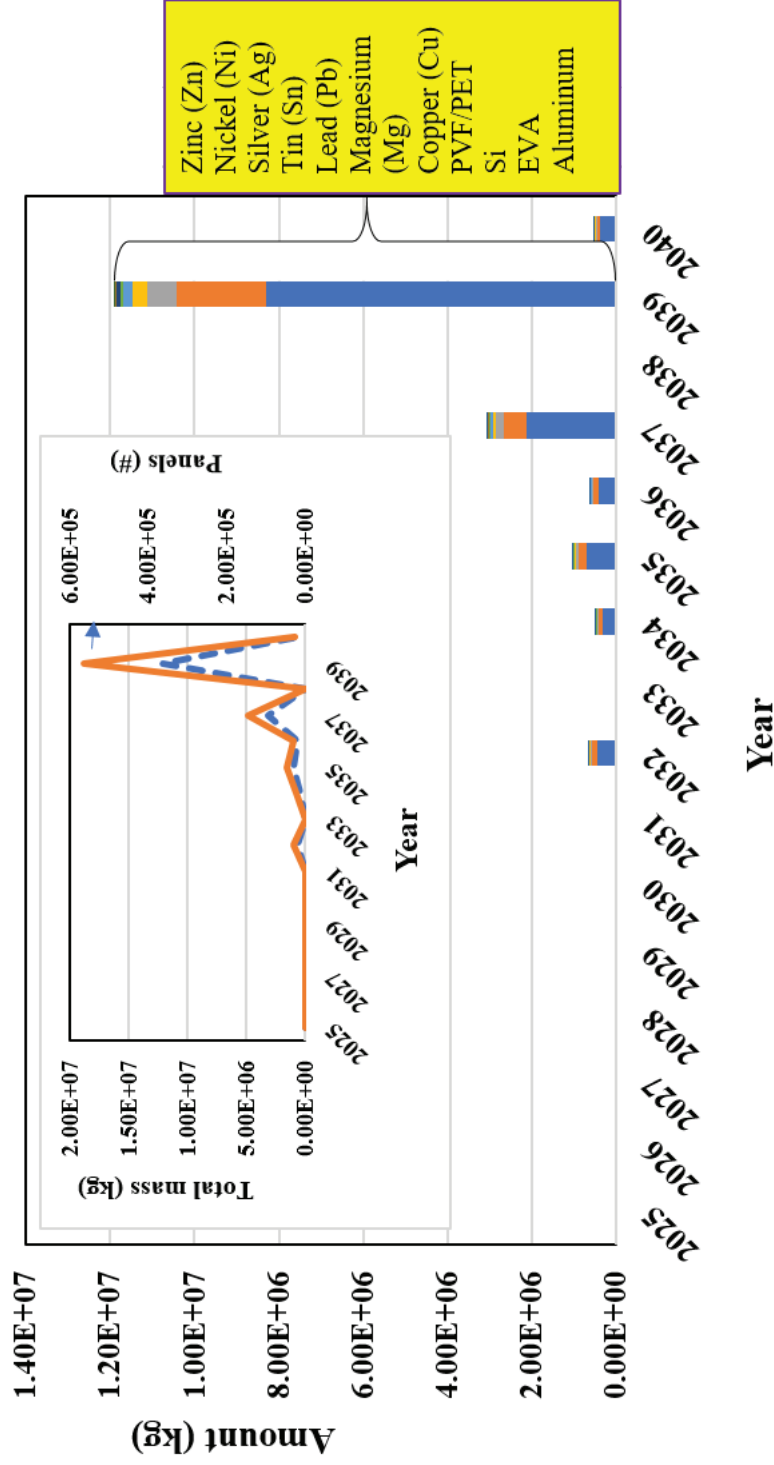

Figure 31. Predicted disposal rates of materials from utility PV modules in Maui County. Inset: Total amount of material load (LHS, blue dotted line) and estimated number of PV modules (RHS, red solid line).

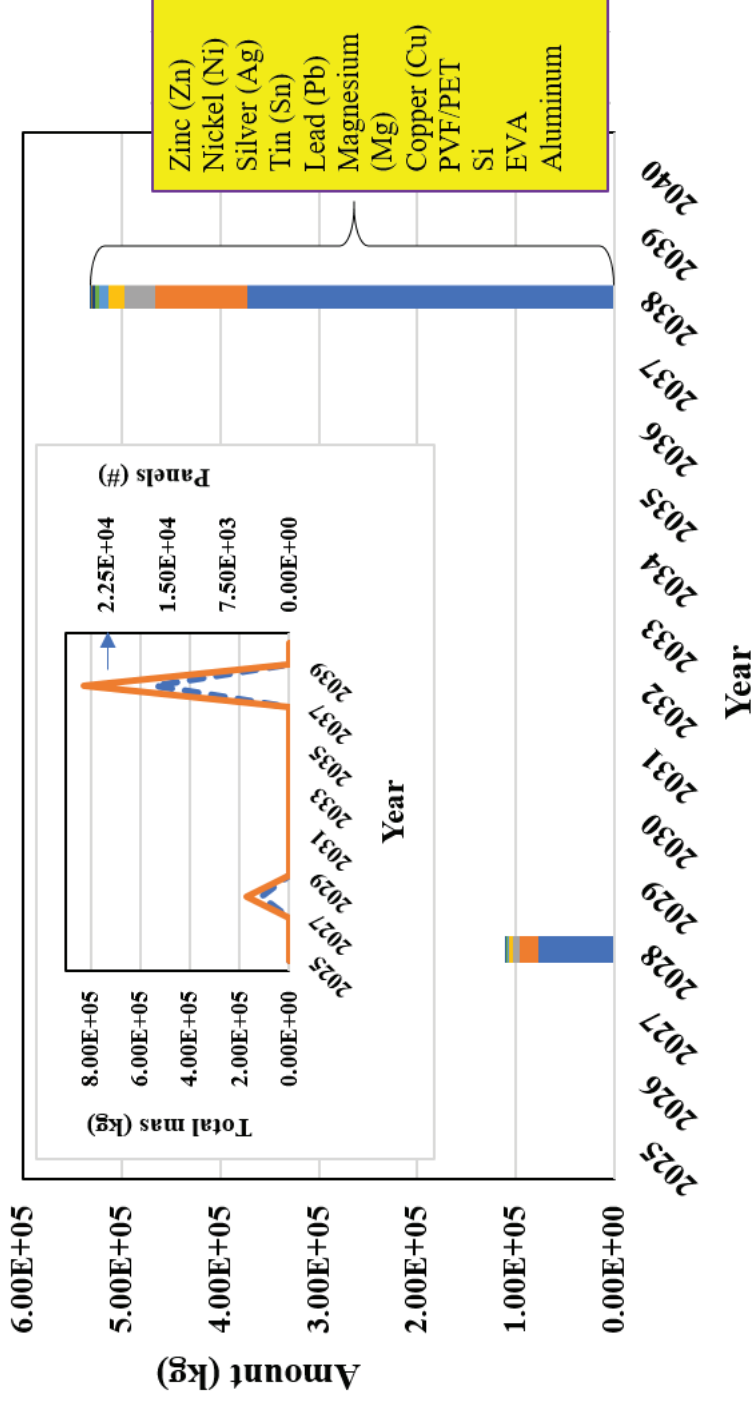

Figure 32. Predicted disposal rates of materials from utility PV modules on Kaua'i. Inset: Total amount of material load (blue dotted line) and estimated number of PV modules (red solid line).

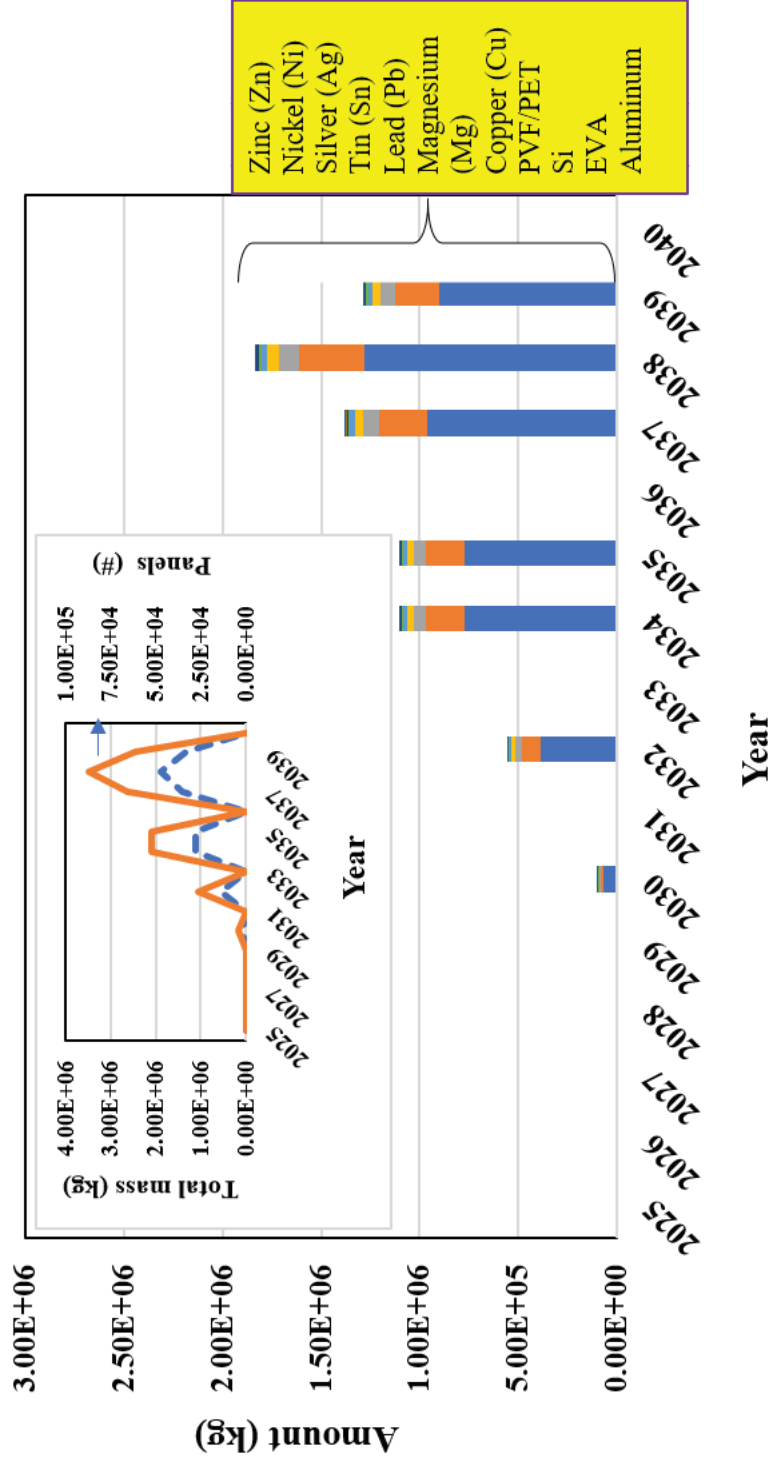
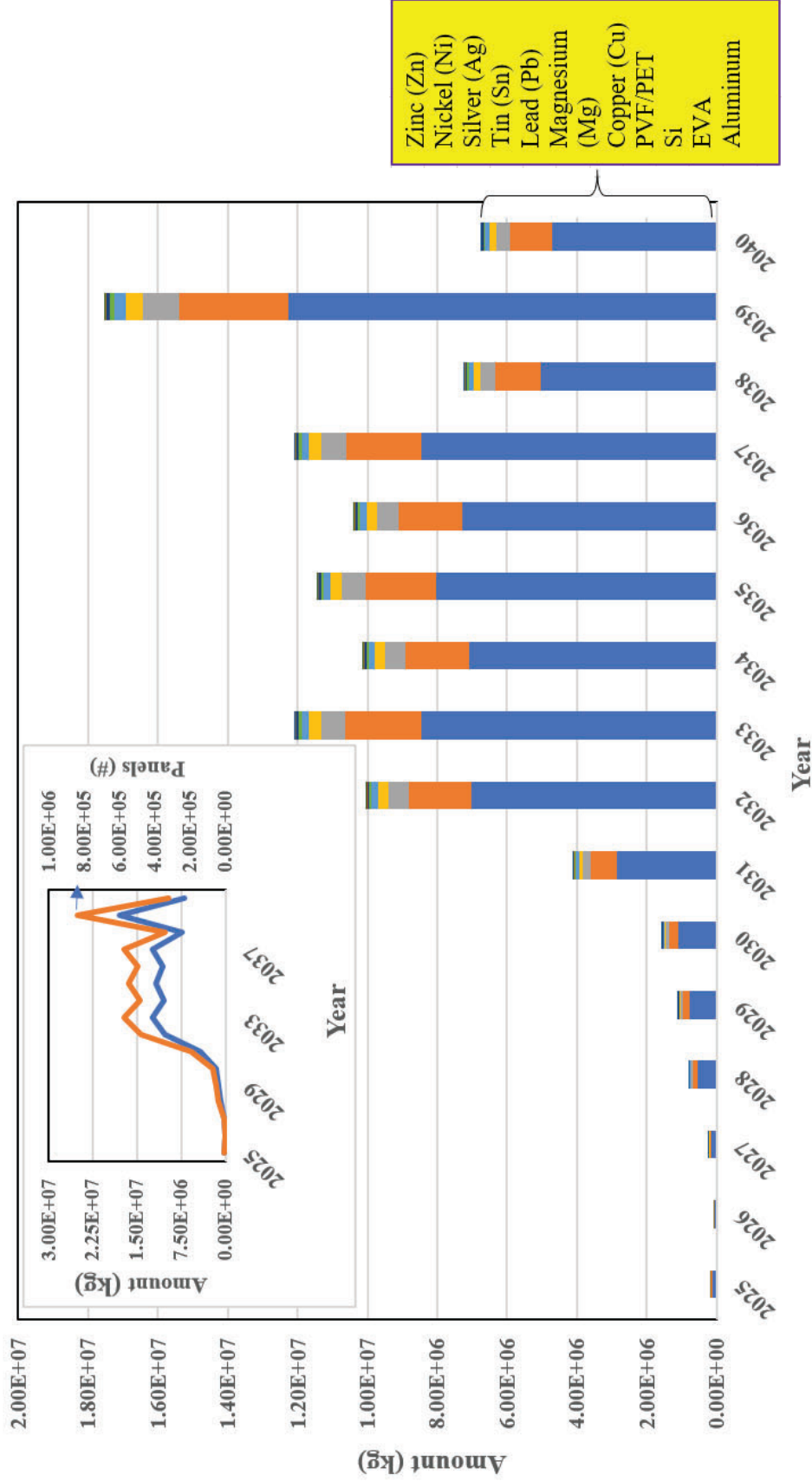

Figure 33. Predicted aggregate disposal rates of materials across all islands and scale. Inset: Total amount of material load (blue dotted line) and estimated number of PV modules (red solid line).



Photovoltaic ancillary components – mounting structures. The lifetime of mounting structures was taken to be the same (i.e., 20 years) as the warranty lifetime of PV modules. Using this assumption, the aggregate rates of material from mounting structures are presented in Figures 34 (metal) and 35 (aluminum). The raw data for these plots is presented in Table A33. The data in Table A33 is further broken down as a function of scale for each island in Tables A34 (residential), A35 (commercial), and A36 (utility).

Figure 34. Aggregate disposal rates of steel from PV mounting structures across all scale for each island through 2040. Legend: O’ahu (solid line), Maui County (dashed line), Hawai’i County (dotted line), and Kaua’i (dashed-dotted line). For O’ahu, use right hand axis; for all other islands, use left hand axis.

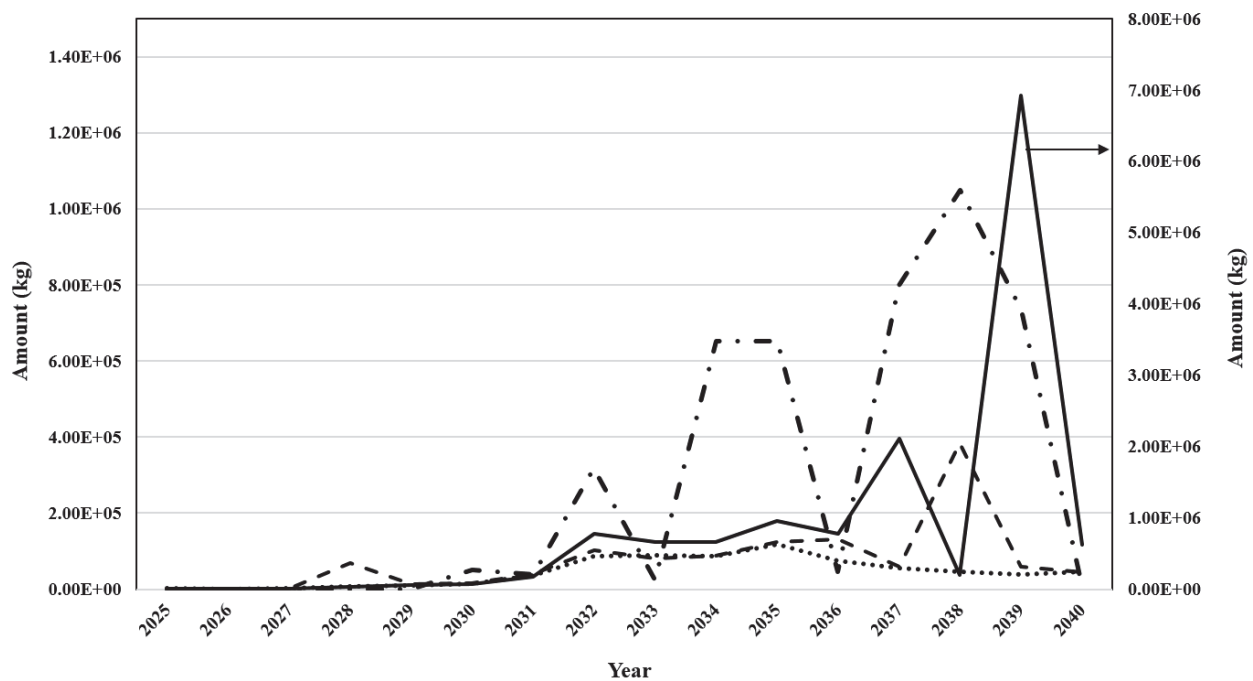
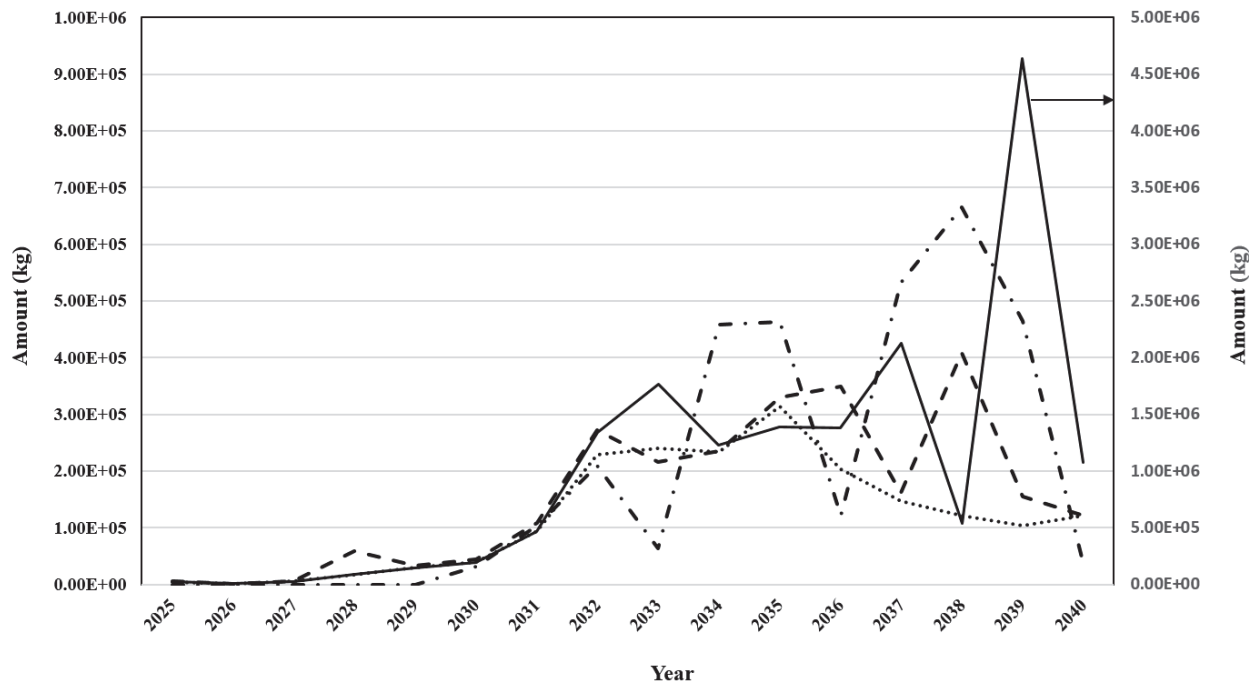
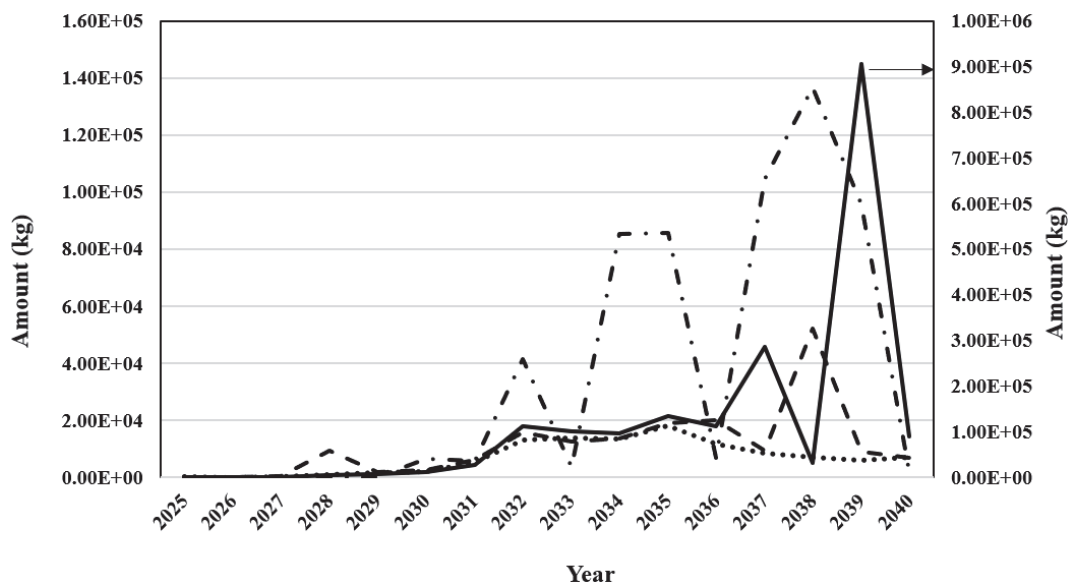

Figure 35. Aggregate disposal rates of aluminum from PV mounting structures across all scale for each island. Legend: O‘ahu (solid line), Maui County (dashed line), Hawai‘i County (dotted line), and Kaua‘i (dashed-dotted line). For O‘ahu, use right hand axis; for all other islands, use left hand axis.



Photovoltaic ancillary components – cabling. The lifetime of cabling was taken to be the same (i.e., 20 years) as the warranty lifetime of PV modules. While this assumption may be on the low side, the time to disposal for cables was set the same as PV modules, mounting structures, and inverters for sake of continuity. In particular, it was assumed that when those other components are replaced at their end of life, new cables would be installed. Using this value, the aggregate disposal rates of material from cabling are presented in Figure 36. The raw data for these plots is presented in Table A37. The data in Table A37 is further broken down as a function of scale for each island in Tables A38 (residential), A39 (commercial), and A40 (utility).

Figure 36. Aggregate disposal rates of copper from PV solar cabling across all scale for each island. Legend: O'ahu (solid line), Maui County (dashed line), Hawai'i County (dotted line), and Kaua'i (dashed-dotted line). For O'ahu, use right hand axis; for all other islands, use left hand axis.



Photovoltaic ancillary components – inverters. Warranty periods for string inverters range from 10 to 20 years while warranty periods for microinverters can be as high as 25 years. That said, microinverters will likely be replaced when the modules are replaced. That being said, and for continuity, the lifetime of the inverters was similarly taken to be the same (i.e., 20 years) as the lifetime of PV modules. Using this data, the aggregate disposal rates of micro and string inverters per island are presented in Figures 37 and 38, respectively. The raw data for these plots is presented in Table A41. The trends of these two figures are similar because they each refer to the same MW_{ac} values. Similar to the other ancillary components, the disposal rate of micro and string inverters remains low until 2030 at which point a significant surge is observed, with as high as a 180,000 microinverters and 9,000 string inverters on O'ahu disposed of in 2033.

The data in Figures 37 and 38 only presents the estimated number of micro and string inverters to be disposed per island. This assumes that the inverters will be disposed as a single unit and shipped off island as electrical waste. As inverters are heavily composed of metals that are routinely recycled, it can be useful to consider their contribution to the aggregate amount of metals loading that will come from ancillary components – assuming the inverters are broken down for their metals and the internal circuit boards handled as e-waste. This data is presented for each island in Figures 39 through 42 and the raw data is presented in the Appendix (Table A42). The variation in trends between aluminum and steel is explained by the relative contribution of utility-scale installations (across individual islands) wherein steel is the more dominant material used in the housings.

Figure 37. Aggregate disposal rates of microinverters at all scale for each island. Legend: O'ahu (solid line), Maui County (dashed line), Hawai'i County (dotted line), and Kaua'i (dashed-dotted line).

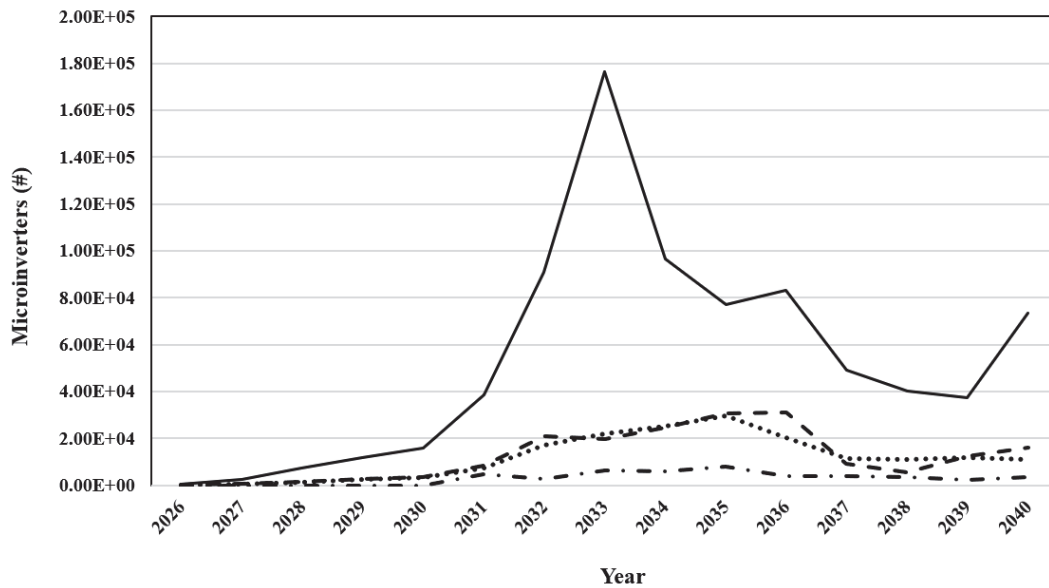

Figure 38. Aggregate disposal rates of string/central inverters at all scale for each island. Legend: O'ahu (solid line), Maui County (dashed line), Hawai'i County (dotted line), and Kaua'i (dashed-dotted line).

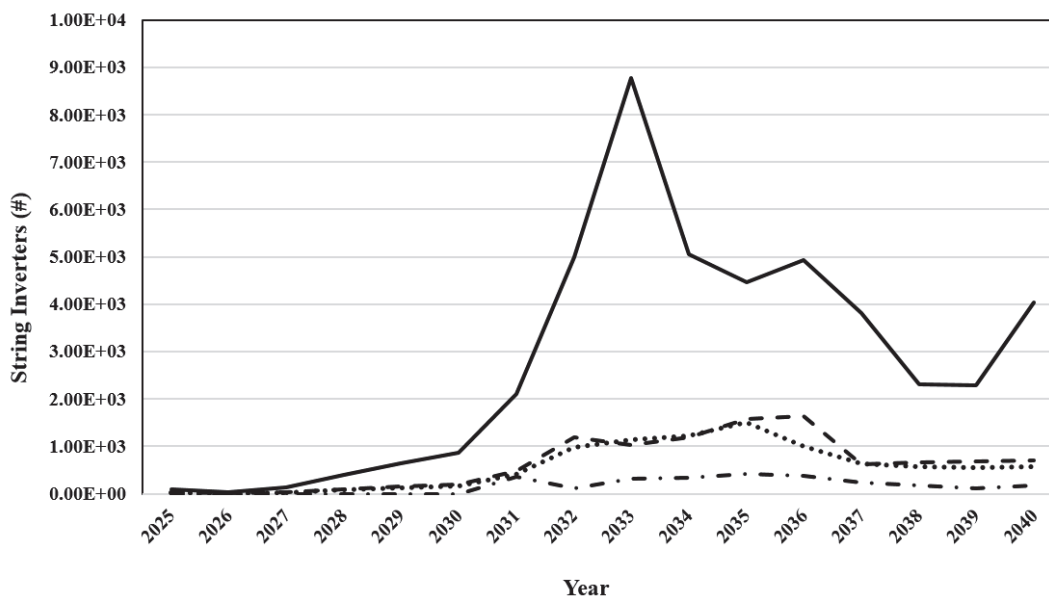

Figure 39. Aggregate metals loading from ancillary components at all scale on the island of O‘ahu. Legend: Copper (solid line), aluminum (dashed line), and steel (dotted line).

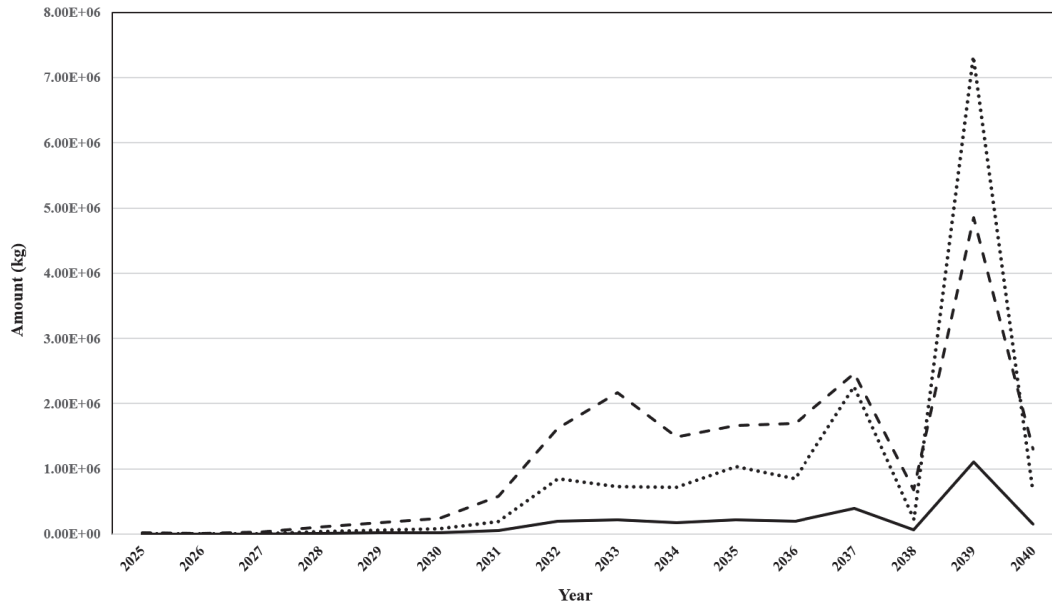

Figure 40. Aggregate metals loading from ancillary components at all scale on the island of Hawai‘i. Legend: Copper (solid line), aluminum (dashed line), and steel (dotted line).

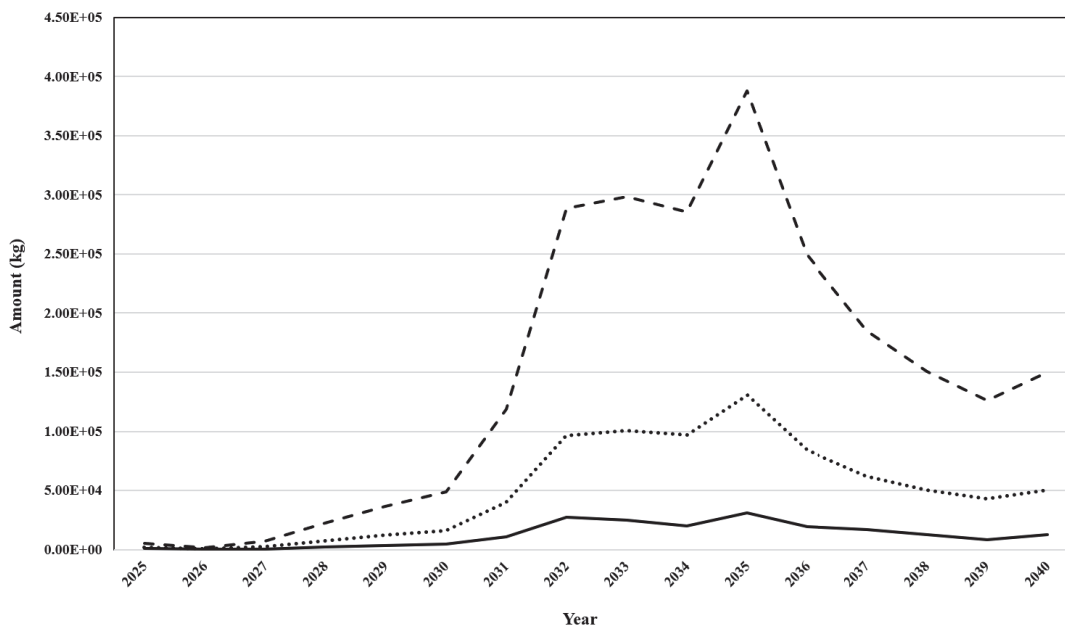

Figure 41. Aggregate metals loading from ancillary components at all scale in Maui County. Legend: Copper (solid line), aluminum (dashed line), and steel (dotted line).

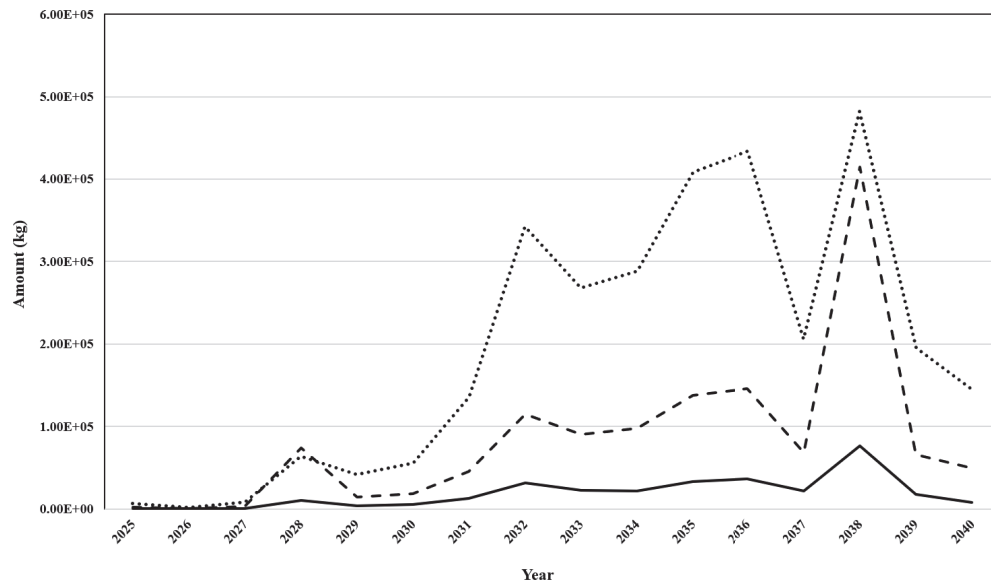
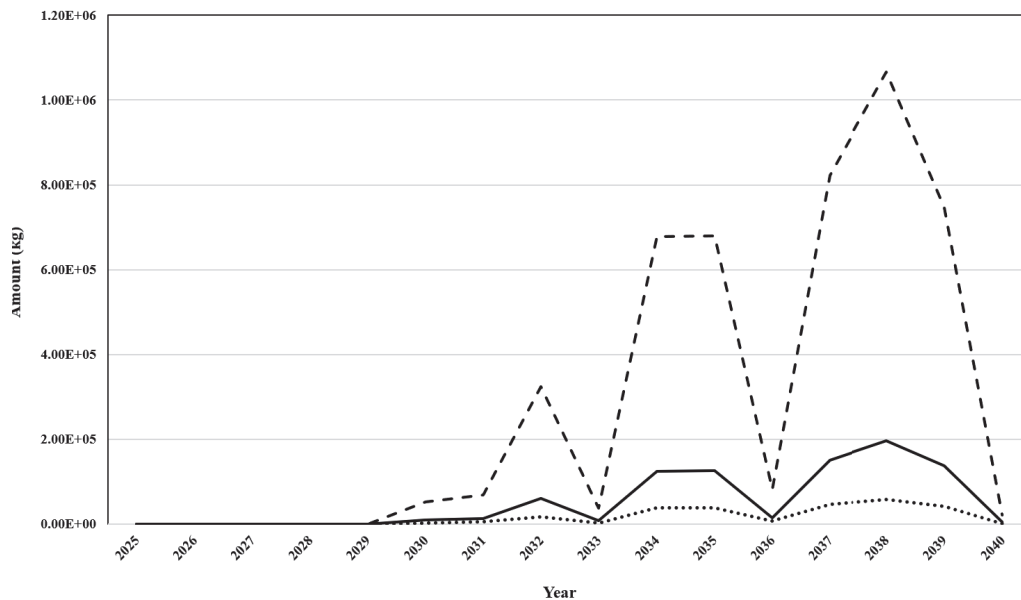

Figure 42. Aggregate metals loading from ancillary components at all scale on the island of Kaua'i. Legend: Copper (solid line), aluminum (dashed line), and steel (dotted line).



Energy Storage Systems

In terms of timing their disposal, EV and energy storage LIBs are typically predicted to be replaced when the battery effectiveness depletes to below 70-80% of its initial capacity [63, 105]. This translates to proposed lifespans of between 8 to 10 years for first-time use in electric vehicles [68] and around 10 years for energy storage systems (residential, commercial, and utility)³². The higher end lifespan of 10 (and as some even propose 15) years assumes favorable operating conditions that avoid overcharging, aggressive use that leads to rapid discharge and more frequent charging, and operation at or exposure to high temperatures [63]. By contrast, in the case of unfavorable conditions, which will more likely occur with EV vehicles, lifetimes can fall as low as 5 years [106]. For these reasons, any attempt to accurately predict lifespans of EV and energy storage LIBs is limited.

Nonetheless, several assumptions have been considered while estimating the quantity and timing of LIB disposal rates. First, a 10-year lifespan has been set for both EV and energy storage LIB. In reality, energy storage batteries will degrade less rapidly but the reuse market remains strong for electric vehicles (i.e., reselling of EVs). Second, it is assumed that, at least in the near future, both EV and energy storage batteries will be directly recycled and not reused [107]. This assumption is based on the reality that the reuse market for EV and energy storage batteries (which are expected to be stationary power [108]) is still undeveloped and underused. As such, for the purposes of this study, the number of EV batteries predicted to enter the waste stream is equated to the number of electric vehicles purchased (i.e., one battery per car purchased). For the near term, this assumption is likely reasonable because the cost to replace a degraded EV battery can be higher than the resale value of the car, a reality that may hamper the resale market and encourage direct salvaging. Third, the typical battery size is 14 kWh (see Appendix, Communications C5) for residential and 100 kWh for commercial [95]. Finally, the percent of residential installs with storage is 87% and commercial 13%. This ratio was calculated from reports that tracked the number of PV plus storage installations at residential and commercial scale on O'ahu between 2017 and 2020 [88].

Electric vehicle batteries. Following the assumption of one battery per car and a 10-year lifespan, the projected disposal loading rates of EV LIBs on O'ahu, in Maui County, and in Hawai'i County are presented in Figure 43. The raw data, presented in Table A43, is based on the data presented in Figure 16A and Table A12 [91]. Because of a lack of published studies projecting EV penetration on Kaua'i, future projections of waste EV batteries on Kaua'i could only be projected through 2030 from existing registration taken from the DBEDT report [90]. According to these numbers, the amount of registered electric vehicles on Kaua'i was only 106 on January 2015 and thereafter increased to only 530 by the end 2021, generally increasing at the relatively low rate of

³² Typical warranty period for energy system storage batteries is 10 years.

60 per year [90]. For the purposes of this report, the disposal rate of EV batteries on Kaua'i was thus approximated as 60 per year through 2030.

As expected the disposal rate of EV LIB generally follows the trends predicted for EV uptake in the State of Hawai'i.

Figure 43. Estimated quantity and timing of EV LIB disposal for O'ahu (straight line), Hawai'i County (dotted line), Maui County (dashed line), and Kaua'i (dashed-dotted line).

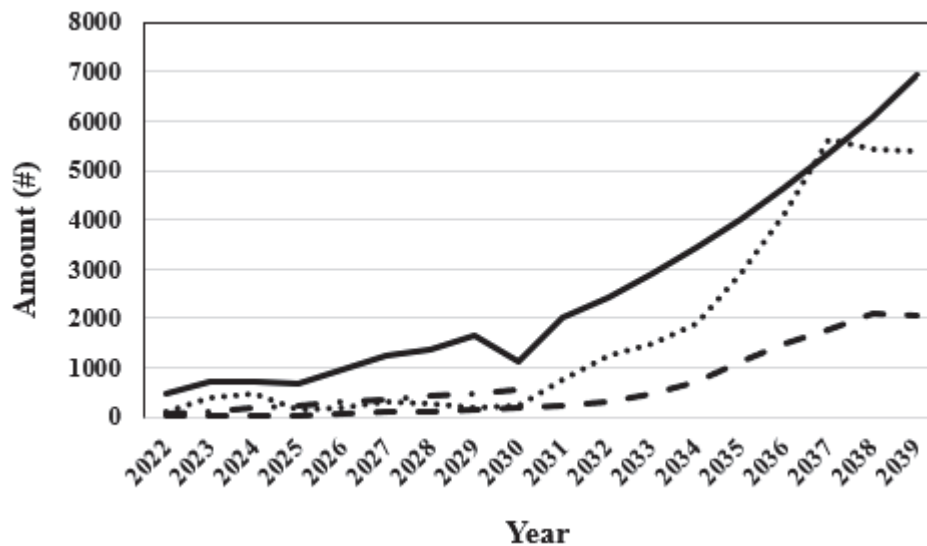

Grid-connected batteries. Figure 44 presents projected grid-connected energy storage LIB disposal across all scales. The raw data is presented in Table A44. The predictions for grid-connected energy storage remain rather low for the island of O'ahu until a sudden surge starts in 2028. This surge reflects the start of energy storage in 2018 as the net metering agreements ended and home storage units became more readily available. Data for the other islands show a similar surge around roughly the same time.

Figure 44. Estimated quantity and timing of grid-connected LIB disposal across all scale for O'ahu (straight line), Hawai'i County (dotted line), Maui County (dashed line), and Kaua'i (dashed-dotted line).

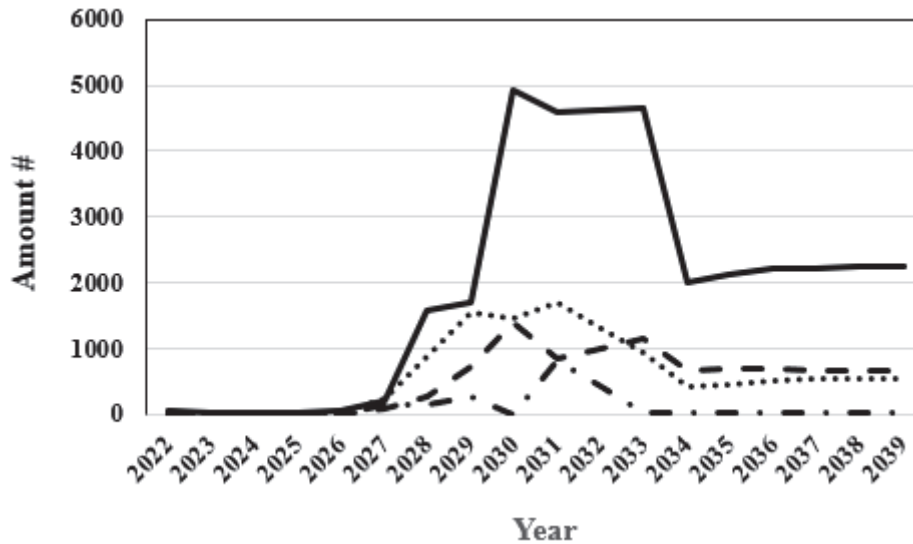

Battery ancillary components – electric vehicles. Ancillary components (i.e., separators, electrolytes, current collectors) ensure that the energy from the battery can be delivered to the vehicle or electrical grid at sufficient energy densities to be useful. When estimating the quantity and timing of disposal rates of ancillary components, the assumption was made that when the battery is disposed or recycled, the associated ancillary components are likewise disposed of or recycled. This report considers the following items as ancillary components: housing (both EV and grid energy storage), battery management system (both EV and grid-connected energy storage), inverter (grid-connected energy storage), cooling system, insulation (EV), and fire suppression (grid-connected energy storage). Not included in this study as ancillary components are cabling (for grid-connected this was considered under PV; for EV this assumed to remain with the car frame).

The quantity and timing of disposal of the ancillary components from EV batteries is calculated using Equation 3 but modified to use the amount of EV batteries disposed per year (Equation 5),

$$Amount (kg) = 28 \frac{kWh}{car} \times disposed\ car\ battery\ (\#) \times energy\ density\ component\ \frac{kg}{kWh} \quad (5)$$

where the number of disposed car batteries (per year) is given in Figure 43 (Table A44) and the energy density of the component being disposed is given in Table 4. The results are presented in Table 12.

Table 12. Estimated disposal loading rates of EV battery ancillary components.

Island	Unit	2022	2023	2024	2025	2026	2027	2028	2029	2030	2031	2032	2033	2034	2035	2036	2037	2038	2039	2040	Totals
Housing Steel or Aluminum - EV packs																					
Oahu	kg	5.80E+03	9.22E+03	9.02E+03	8.76E+03	1.19E+04	1.57E+04	1.70E+04	2.06E+04	1.43E+04	2.55E+04	3.07E+04	3.65E+04	4.32E+04	5.05E+04	5.85E+04	6.72E+04	7.68E+04	8.71E+04	9.81E+04	1.38E+05
Hawaii	kg	5.04E+02	2.52E+02	6.17E+02	3.02E+02	8.19E+02	1.37E+03	1.32E+03	2.00E+03	2.29E+03	2.80E+03	3.97E+03	5.75E+03	9.24E+03	1.42E+04	1.87E+04	2.24E+04	2.65E+04	2.58E+04	2.84E+04	1.33E+04
Maui	kg	1.16E+03	5.01E+03	6.14E+03	1.78E+03	2.47E+03	3.78E+03	3.38E+03	2.27E+03	2.76E+03	9.75E+03	1.56E+04	1.88E+04	2.39E+04	3.65E+04	5.23E+04	7.11E+04	8.87E+04	6.79E+04	9.14E+04	3.85E+04
Housing Plastics - EV packs																					
Oahu	kg	1.29E+03	2.03E+03	2.00E+03	1.95E+03	2.64E+03	3.48E+03	3.78E+03	4.58E+03	3.18E+03	5.66E+03	6.82E+03	8.11E+03	9.59E+03	1.12E+04	1.30E+04	1.49E+04	1.71E+04	1.94E+04	2.18E+04	3.06E+04
Hawaii	kg	1.12E+02	5.60E+01	1.37E+02	6.72E+01	1.82E+02	3.05E+02	2.94E+02	4.43E+02	5.10E+02	6.22E+02	8.82E+02	1.28E+03	2.05E+03	3.16E+03	4.17E+03	4.98E+03	5.89E+03	5.73E+03	6.32E+03	2.73E+03
Maui	kg	2.58E+02	1.11E+03	1.36E+03	3.95E+02	5.49E+02	8.40E+02	7.50E+02	5.04E+02	6.13E+02	2.17E+03	3.48E+03	4.18E+03	5.31E+03	8.10E+03	1.16E+04	1.58E+04	1.53E+04	1.51E+04	2.03E+04	8.55E+03
Battery Management System (electronics) - EV packs																					
Oahu	kg	6.44E+01	1.02E+02	1.00E+02	9.73E+01	1.32E+02	1.74E+02	1.89E+02	2.29E+02	1.59E+02	2.83E+02	3.41E+02	4.06E+02	4.80E+02	5.61E+02	6.50E+02	7.46E+02	8.53E+02	9.68E+02	1.09E+03	1.53E+03
Hawaii	kg	5.60E+00	2.80E+00	6.86E+00	3.36E+00	9.10E+00	1.53E+01	1.47E+01	2.23E+01	2.55E+01	3.11E+01	4.41E+01	6.38E+01	1.03E+02	1.58E+02	2.08E+02	2.49E+02	2.94E+02	2.87E+02	3.16E+02	1.37E+02
Maui	kg	1.29E+01	5.57E+01	6.82E+01	1.97E+01	2.74E+01	4.20E+01	3.75E+01	2.52E+01	3.07E+01	1.08E+02	1.74E+02	2.09E+02	2.66E+02	4.05E+02	5.81E+02	7.90E+02	7.63E+02	7.54E+02	1.02E+03	4.28E+02
Cooling System (glycol) - EV packs																					
Oahu	kg	7.73E+02	1.23E+03	1.20E+03	1.17E+03	1.59E+03	2.09E+03	2.27E+03	2.73E+03	1.91E+03	3.40E+03	4.09E+03	4.87E+03	5.76E+03	6.74E+03	7.80E+03	8.93E+03	1.02E+04	1.16E+04	1.31E+04	1.84E+04
Hawaii	kg	6.72E+01	3.36E+01	8.23E+01	4.03E+01	1.09E+02	1.83E+02	1.76E+02	2.67E+02	3.06E+02	3.73E+02	5.29E+02	7.66E+02	1.23E+03	1.90E+03	2.50E+03	2.99E+03	3.53E+03	3.44E+03	3.79E+03	1.64E+03
Maui	kg	1.53E+02	6.69E+02	8.18E+02	2.37E+02	3.29E+02	5.04E+02	4.50E+02	3.02E+02	3.68E+02	1.30E+03	2.09E+03	2.51E+03	3.19E+03	4.86E+03	6.97E+03	9.48E+03	9.15E+03	9.05E+03	1.22E+04	5.13E+03
Insulation - EV packs																					
Oahu	kg	2.58E+02	4.10E+02	4.01E+02	3.89E+02	5.29E+02	6.97E+02	7.57E+02	9.13E+02	6.37E+02	1.13E+03	1.36E+03	1.62E+03	1.92E+03	2.25E+03	2.60E+03	2.98E+03	3.41E+03	3.87E+03	4.36E+03	6.12E+03
Hawaii	kg	2.24E+01	1.12E+01	2.74E+01	1.34E+01	3.64E+01	6.10E+01	5.88E+01	8.90E+01	1.02E+02	1.24E+02	1.76E+02	2.55E+02	4.10E+02	6.32E+02	8.33E+02	9.93E+02	1.18E+03	1.15E+03	1.26E+03	5.46E+02
Maui	kg	5.13E+01	2.23E+02	2.73E+02	7.90E+01	1.10E+02	1.68E+02	1.50E+02	1.01E+02	1.23E+02	4.33E+02	6.96E+02	8.36E+02	1.06E+03	1.62E+03	2.32E+03	3.16E+03	3.05E+03	3.02E+03	4.06E+03	1.71E+03

Battery ancillary components – grid-connected energy storage. Similar to the calculations on battery ancillary components from electric vehicles, the amount of quantity and timing of disposal of the ancillary components from grid-connected energy storage is calculated using Equation 5 but modified to use the amount of storage disposed instead of cumulative (Equation 6),

$$\text{Amount (kg)} = \text{disposed storage (MWh)} \times \text{energy density component} \frac{\text{kg}}{\text{kWh}} \times 1000 \frac{\text{kWh}}{\text{MWh}} \quad (6)$$

where the amount of disposed storage (per year) is given in Figure 44 (Table A44) and the energy density of the component being disposed given in Table 4. The results are presented in Table 13.

Table 13. Estimated disposal loading rates of grid-connected battery ancillary components.

Island	Unit	2022	2023	2024	2025	2026	2027	2028	2029	2030	2031	2032	2033	2034	2035	2036	2037	2038	2039	2040	Totals
Housing Steel - Grid Storage																					
Oahu	kg	1.46E+03	6.24E+02	2.26E+02	7.02E+02	2.04E+03	6.31E+03	4.99E+04	5.33E+04	1.58E+05	1.45E+05	2.07E+06	1.08E+06	6.70E+04	6.95E+04	6.95E+04	7.00E+04	7.12E+04	7.08E+04	6.95E+04	4.15E+05
Hawaii	kg	4.87E+02	0.00E+00	7.02E+00	0.00E+00	2.26E+02	7.22E+03	2.74E+04	4.89E+04	4.60E+04	5.32E+04	5.09E+05	3.70E+04	1.45E+04	1.61E+04	1.61E+04	1.67E+04	1.67E+04	1.73E+04	1.74E+04	1.83E+05
Mauai	kg	1.08E+02	0.00E+00	0.00E+00	0.00E+00	8.10E+01	6.98E+03	7.89E+03	2.31E+04	4.34E+04	2.70E+04	5.16E+05	1.12E+06	2.14E+04	2.14E+04	2.09E+04	2.07E+04	2.09E+04	2.08E+04	1.98E+04	1.09E+05
Kauai	kg	0.00E+00	0.00E+00	0.00E+00	9.20E+03	0.00E+00	1.08E+05	2.04E+05	8.53E+03	0.00E+00	2.54E+04	0.00E+00	0.00E+00	0.00E+00	0.00E+00	0.00E+00	0.00E+00	0.00E+00	0.00E+00	0.00E+00	3.55E+05
Battery Management System (electronics) - Grid Storage																					
Oahu	kg	7.29E+00	3.12E+00	1.13E+00	3.51E+00	1.02E+01	3.16E+01	2.50E+02	2.67E+02	7.78E+02	7.23E+02	1.04E+04	5.39E+03	3.35E+02	3.47E+02	3.50E+02	3.56E+02	3.56E+02	3.54E+02	3.49E+02	2.08E+03
Hawaii	kg	2.43E+00	0.00E+00	3.51E+02	0.00E+00	1.13E+00	3.61E+01	1.37E+02	2.44E+02	2.30E+02	2.66E+02	2.55E+03	1.85E+02	7.27E+01	8.06E+01	8.33E+01	8.34E+01	8.34E+01	8.63E+01	8.72E+01	9.17E+02
Mauai	kg	5.40E+01	0.00E+00	0.00E+00	0.00E+00	4.05E+01	3.49E+01	3.95E+01	1.16E+02	2.17E+02	1.35E+02	2.38E+03	5.60E+03	1.07E+02	1.07E+02	1.04E+02	1.04E+02	1.04E+02	1.04E+02	9.88E+01	5.43E+02
Kauai	kg	0.00E+00	0.00E+00	0.00E+00	4.60E+01	0.00E+00	5.41E+02	1.02E+03	4.26E+01	-4.20E+00	1.27E+02	0.00E+00	0.00E+00	0.00E+00	0.00E+00	0.00E+00	0.00E+00	0.00E+00	0.00E+00	0.00E+00	1.77E+03
Inverter - Grid Energy																					
Oahu	kg	2.04E+02	8.74E+01	3.16E+01	9.83E+01	2.85E+02	8.84E+02	6.99E+03	7.46E+03	2.18E+04	2.03E+04	2.90E+05	1.51E+05	9.39E+03	9.72E+03	9.80E+03	9.90E+03	9.90E+03	9.92E+03	9.78E+03	5.81E+04
Hawaii	kg	6.81E+01	0.00E+00	9.83E+01	0.00E+00	3.16E+01	1.01E+03	3.84E+03	6.84E+03	6.44E+03	7.45E+03	7.13E+04	5.18E+03	2.04E+03	2.26E+03	2.33E+03	2.34E+03	2.34E+03	2.42E+03	2.44E+03	2.57E+04
Mauai	kg	1.51E+01	0.00E+00	0.00E+00	0.00E+00	1.13E+01	9.77E+02	1.11E+03	3.24E+03	6.08E+03	3.78E+03	7.23E+04	1.57E+05	3.00E+03	3.00E+03	2.90E+03	2.92E+03	2.92E+03	2.91E+03	2.77E+03	1.52E+04
Kauai	kg	0.00E+00	0.00E+00	0.00E+00	1.29E+03	0.00E+00	1.51E+04	2.83E+04	1.19E+03	-1.18E+02	3.55E+03	0.00E+00	0.00E+00	0.00E+00	0.00E+00	0.00E+00	0.00E+00	0.00E+00	0.00E+00	0.00E+00	4.96E+04
Cooling System (system) - Grid Storage																					
Oahu	kg	8.02E+01	3.45E+01	1.24E+01	3.86E+01	1.12E+02	3.47E+02	2.73E+03	2.93E+03	8.56E+03	7.98E+03	1.14E+05	5.93E+04	3.69E+03	3.82E+03	3.83E+03	3.91E+03	3.91E+03	3.90E+03	3.84E+03	2.28E+04
Hawaii	kg	2.68E+01	0.00E+00	3.86E+01	0.00E+00	1.24E+01	3.97E+02	1.51E+03	2.69E+03	2.53E+03	2.92E+03	2.80E+04	2.03E+03	8.00E+02	8.87E+02	9.17E+02	9.18E+02	9.18E+02	9.49E+02	9.39E+02	1.01E+04
Mauai	kg	5.94E+00	0.00E+00	0.00E+00	0.00E+00	4.46E+00	3.84E+02	4.34E+02	1.27E+03	2.39E+03	1.49E+03	2.84E+04	6.16E+04	1.18E+03	1.18E+03	1.14E+03	1.15E+03	1.15E+03	1.14E+03	1.09E+03	5.98E+03
Kauai	kg	0.00E+00	0.00E+00	0.00E+00	5.06E+02	0.00E+00	5.95E+03	1.12E+04	4.69E+02	-4.62E+01	1.40E+03	0.00E+00	0.00E+00	0.00E+00	0.00E+00	0.00E+00	0.00E+00	0.00E+00	0.00E+00	0.00E+00	1.95E+04
Fire Suppression (steel) - Grid Energy																					
Oahu	kg	4.37E+01	1.87E+01	6.77E+00	2.11E+01	6.11E+01	1.89E+02	1.50E+03	1.60E+03	4.67E+03	4.35E+03	6.21E+04	3.24E+04	2.01E+03	2.08E+03	2.10E+03	2.13E+03	2.13E+03	2.12E+03	2.10E+03	1.25E+04
Hawaii	kg	1.46E+01	0.00E+00	2.11E+01	0.00E+00	6.77E+00	2.17E+02	8.22E+02	1.47E+03	1.38E+03	1.60E+03	1.53E+04	1.11E+03	4.36E+02	4.84E+02	5.00E+02	5.01E+02	5.01E+02	5.18E+02	5.23E+02	5.50E+03
Mauai	kg	3.24E+00	0.00E+00	0.00E+00	0.00E+00	2.43E+00	2.09E+02	2.37E+02	6.93E+02	1.30E+03	8.11E+02	1.55E+04	3.36E+04	6.42E+02	6.42E+02	6.22E+02	6.22E+02	6.24E+02	6.24E+02	5.93E+02	3.26E+03
Kauai	kg	0.00E+00	0.00E+00	0.00E+00	2.76E+02	0.00E+00	3.25E+03	6.11E+03	2.56E+02	-2.52E+01	7.61E+02	0.00E+00	0.00E+00	0.00E+00	0.00E+00	0.00E+00	0.00E+00	0.00E+00	0.00E+00	0.00E+00	1.06E+04
Fire Suppression (fire suppressant) - Grid Energy																					
Oahu	kg	1.46E+01	6.24E+00	2.26E+00	7.02E+00	2.04E+01	6.31E+01	4.99E+02	5.33E+02	1.56E+03	1.45E+03	2.07E+04	1.08E+04	6.70E+02	6.95E+02	7.00E+02	7.12E+02	7.08E+02	6.95E+02	4.15E+03	
Hawaii	kg	4.87E+00	0.00E+00	7.02E+02	0.00E+00	2.26E+00	7.22E+01	2.74E+02	4.89E+02	4.60E+02	5.32E+02	5.09E+03	3.70E+02	1.45E+02	1.61E+02	1.61E+02	1.67E+02	1.67E+02	1.73E+02	1.74E+02	1.83E+03
Mauai	kg	1.08E+00	0.00E+00	0.00E+00	0.00E+00	8.10E+01	6.98E+01	7.89E+01	2.31E+02	4.34E+02	2.70E+02	5.16E+03	1.12E+04	2.14E+02	2.14E+02	2.09E+02	2.07E+02	2.09E+02	2.08E+02	1.98E+02	1.09E+03
Kauai	kg	0.00E+00	0.00E+00	0.00E+00	9.20E+01	0.00E+00	1.08E+03	2.04E+03	8.53E+01	-8.40E+00	2.54E+02	0.00E+00	0.00E+00	0.00E+00	0.00E+00	0.00E+00	0.00E+00	0.00E+00	0.00E+00	0.00E+00	3.54E+03

Solar Hot Water Systems

Estimating the disposal rate of solar hot water heaters is difficult. These systems are off-grid and independent appliances and records of their purchase and installation are spread over a vast array of installers. Moreover, lifetimes vary across manufacturers and time of disposal is more often a personal decision of homeowners influenced by a variety of issues including maintenance, renovation, fault, and buyer incentive programs. Given that solar hot water heater panels and additional ancillary components are non-hazardous and already integrated into well-established disposal pathways, the timing of their disposal has not been considered in this report.

Summary

A total of 225,000 tons of PV related clean energy materials have been installed in Hawai'i through 2021³³. For context, the total amount of municipal solid waste and commercial/demolition waste generated in the State during 2021 was 2,570,478 tons [2]. This suggests that the total amount of these PV related clean energy materials installed to date approximates 8.8% of all municipal solid waste and commercial/demolition waste generated across the entire State in 2021. More, the 15 to 20-year time frame for PV and 10 to 15-year time frame for batteries means that their total percentage waste on an annual basis is more like 1% of the total. The major contributors (both PV panel and lithium ion batteries) require collection, disposal, and recycle steps designed for hazardous materials. Going forward, these new and emerging waste streams will begin to accelerate during the latter half of this decade.

³³ This includes PV cabling, mounting structures, inverters, and panels (across all islands and scale), electric vehicle batteries, and energy storage batteries.

BEST PRACTICES FOR COLLECTION, DISPOSAL, AND RECYCLING OF CLEAN ENERGY MATERIALS

This section provides an overview of best practices for the collection, disposal, and recycling of modules, batteries, and ancillary components from clean energy systems. This section also provides a brief overview of the state-of-the-art recycling technologies for each system. The end-of-life management of clean energy materials considered in this report will generally comprise several steps: (1) collection, (2) transport, (3) dismantling, (4) separation of non-compositional materials, (5) refinement of such materials, and (6) reuse of recovered/refined materials (Figure 45) [109].

Figure 45. General process flow diagram for end-of-life management of clean energy materials.

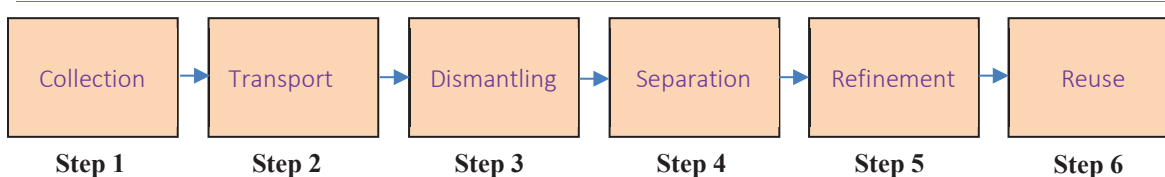

Each step in Figure 45 will possess unique characteristics with respect to the specific clean energy material being processed. It is important to note, that because of the distinctive chemistries and compositions among various PV modules and LIBs, no single recycling and purification process is guaranteed to fit all modules or batteries (which is unlike the situation for lead acid batteries) [EPRI Recycling, 2017 [110]].

Hazardous or Universal Waste Classification

Under the Resource Conservation and Recovery Act (RCRA)³⁴, anyone generating solid wastes must determine if they are hazardous waste (HW) [111]. Solid waste can be determined to be hazardous if it is specifically listed as hazardous in the regulations, or if it is demonstrated to exhibit a hazardous, characteristic (ignitability, corrosivity, reactivity, or toxicity). The waste generator is required to perform a hazardous waste determination, using analytical test results or generator knowledge. When analytical testing is performed, the U.S. EPA and the State of Hawai'i Hazardous Waste Program then require the application of the Toxicity Characteristic Leaching Procedure (TCLP) [112] to determine if a waste exhibits the characteristic of toxicity under the Resource Conservation and Recovery Act (RCRA) [113]. The Toxicity Characteristic Leaching Procedure (TCLP) is a "second-generation" extraction procedure developed by the U.S. EPA as a waste characterization tool (see Appendix, Communications C6). In general, it would be quite

³⁴ 42 U.S.C. §6901 et seq. (1976).

expensive and impractical to expect most generators of small amounts of waste (e.g., PV modules) to order this type of testing to make a hazardous waste determination. In this case, the disposer of a specific waste can reference established knowledge. If pursued, however, this knowledge must be from a legitimate and documented source, such as safety data sheets (SDS³⁵) provided by the manufacturer. In some instances, however, as may be the case for PV modules installed on a house 25-30 years ago, the manufacturer is unknown and/or no longer exists and cannot be relied on to provide data. In these circumstances the simplest and most practical practice is for the generator to decide to assume that their waste (e.g., PV modules) is hazardous and to manage the waste as a hazardous waste.

In Hawai'i, the hazardous waste rules (Chapters 11-260 to 11-279.1, Hazardous Administrative Rules [HAR]) require businesses to decide whether their waste meets the legal definition of hazardous waste [40 CFR section 262.11, as incorporated and amended in Chapter 11-262.1, HAR]. If something is determined to be hazardous (i.e., because it's ignitable, corrosive, reactive, toxic, or is a listed waste), then it must be managed under hazardous waste regulations, which in a practical sense means that in Hawai'i, it must be shipped to a permitted facility on the U.S. mainland. Universal waste is a category of waste materials designated as "hazardous waste", but containing very common materials. Universal waste standards allow longer storage times, more relaxed standards during storage, collection, and storage by third parties, and shipping without a Uniform Hazardous Waste Manifest. The universal waste regulations, however, do require that the materials be managed in a way that prevents the release of harmful constituents to the environment. These requirements are tailored to each specific type of universal waste. Standards for universal waste also include a labeling requirement, a requirement to respond to releases, and a requirement for universal waste to ultimately be managed at a facility that is permitted or otherwise designated for receiving hazardous waste, such as a hazardous waste recycler.

Large quantity handlers of universal waste (handlers accumulating over 5,000 kg of universal waste *are* required to notify DOH using EPA form 8700-12 and receive an EPA ID number [40 CFR section 273.32, as incorporated and amended in Chapter 11-273.1, HAR]. Small quantity handlers of universal waste are not required to notify and receive an EPA ID number.

Photovoltaic Systems

The pathway for comprehensive end-of-life treatment applied to photovoltaic modules is presented in Figure 46. Steps 1 and 2 refers to the collection and transport of photovoltaic modules to storage and/or processing facilities [114] (see Appendix, Communications C7). Step 3 refers to the recovery of the junction box and associated cabling as well as the separation of the frame from the PV module. Step 4 refers to processes that separate the materials that make up the solar cell (i.e.,

³⁵ See OSHA Brief at <https://www.osha.gov/sites/default/files/publications/OSHA3514.pdf>. Last accessed on 9/24/2022.

substrate, EVA, tab ribbon, solar cell). These include delamination³⁶ followed by various combinations of mechanical (e.g., crushing and sieving), thermal (incineration³⁷), or chemical (e.g., solvent extraction) treatments for metals recovery and purification [10, 11, 18, 114-118]. Step 5 refers to the further processing and purification of the separated materials by a refinery [9, 114]. Step 5 of recovered/refined materials refers to the reuse of the purified materials to help promote a truly circular economy within the well-established PV industry [119]. More specific commentary on these steps as they apply to the collection, disposal, and recycling of PV modules and their ancillary components is now provided.

³⁶ A lighter application of thermal (or chemical with organic/inorganic solvents) treatment to remove/decompose the EVA polymer film prior to additional steps to recover the underlying valuable elements.

³⁷ The high temperature combustion of the module (minus the junction box and frame) to gas emissions, hazardous fly ash and a bottom ash that is subjected to various treatments (sieving, filtration, electrolysis) to recover select elements such as scrap aluminum, silicon, silver and copper.

Figure 46. End-of-life management of photovoltaic systems.

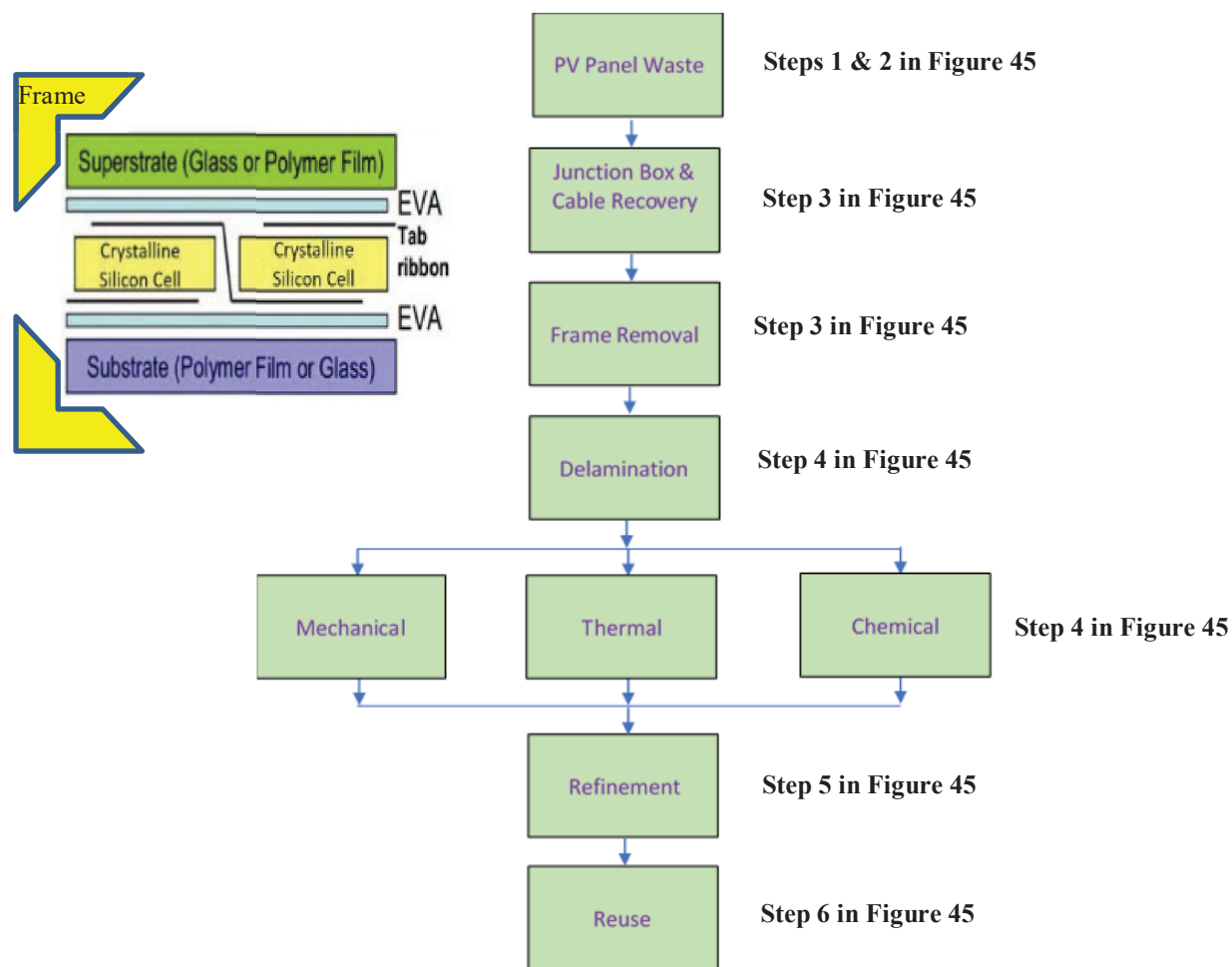

PV modules – collection. In Hawai‘i, effective June 7th, 2021, PV modules may be managed as universal waste³⁸. Under this provision, PV modules are prohibited from being commingled with other universal wastes, such as electronic items, when collected and transported due to the need to comply with the specific requirements associated with each waste stream. Specifically, each solar PV module, container, or pallet containing solar PV modules or designated universal waste solar PV module storage area demarcated by boundaries, must be labeled (or marked) clearly³⁹. Universal waste storage requirements for collected modules are performance based and do not specify how the PV modules must be stored to prevent their breakage and the release of hazardous materials. Collection containers must be structurally sound and prevent releases under reasonably unforeseeable conditions. Examples include placing PV modules in containers or placing them on

³⁸ Chapter 11-273.1 HAR.

³⁹ Solar PV modules cannot be comingled with other types of universal waste because they must be labeled or marked with one of the following phrases: “Universal Waste—solar panel(s)”, or “Waste solar panel(s)”, or “Used solar panel(s)” [40 CFR section 273.14(h) and 273.34(h), as incorporated and amended in chapter 11-273.1, HAR].

a pallet and then shrink wrapping that pallet. Under universal waste regulations, island-based recyclers/salvagers are allowed to collect, transport, and consolidate PV modules (i.e., interisland shipping to centralized collection sites) but in doing so the PV modules must be contained in a manner that prevents their breakage and the release of any hazardous material to the environment. During collection, universal waste handlers are required to immediately clean up any PV module or PV module constituent(s) if the module is accidentally or unintentionally broken. Broken pieces must be immediately cleaned up and containerized to minimize the potential release. Finally, their management as universal waste allows island-based recyclers/salvagers to ship collected PV modules to mainland recyclers for recycling or hazardous waste disposal (see Appendix, Communications C8). The reduced obligations of the universal waste regulations offer additional cost savings. Modules can be sent for recycling without using a uniform hazardous waste manifest and handlers can store the modules for up to a year to collect enough to make shipping them more economical.

PV modules – disposal. The two main pathways for disposal of PV modules are landfill and incineration. PV modules are currently landfilled in the continental U.S. [120] and recent studies have suggested that this practice is not as severe of an environmental concern as previously thought [20]. For example, studies have shown that the exposure point concentrations of key chemicals (Pb, Cd, and Se) from c-SI modules are at least one order of magnitude below U.S. EPA health screening values in soil, air, and water and that landfilling PV modules could even be safe [121]. Moreover, in contrast with the emerging thin-film modules, the crystalline silicon modules do not contain significant highly toxic substances like gallium or cadmium telluride [122]. Nonetheless, the crystalline silicon modules contain tiny amounts of lead and tin which can cause legitimate unwanted environmental and health effects [122] and future trends suggest the more toxic thin film modules will enter the market. For these and other reasons, the calls for banning landfilling instead of recycling PV modules are increasing [111, 123].

In Hawai'i, materials classified as hazardous waste cannot be landfilled by commercial contractors. However, there is one exception to this rule. Generators of less than 220 pounds⁴⁰ of hazardous waste per month (known as “very small quantity generators, or VSQGs”) may legally dispose of hazardous waste in a municipal solid waste landfill. In addition, there are other instances where waste solar PV modules are not regulated as hazardous waste: the first is if the generator is able to show, through use of the Toxicity Characteristic Leaching Procedure (TCLP) [112] or legitimate generator knowledge, that the specific type of PV module being disposed of does not exhibit the regulated thresholds of toxicity and is not otherwise hazardous. This is important because even though nearly all of the current PV modules in Hawai'i are silicon-based crystalline cells (c-Si), they nonetheless can pose environmental risk for the leaching of toxic elements (e.g., lead) into the environment [24, 124-126]. The second is when the waste falls under the household hazardous waste (HHW) exclusion. Household hazardous waste is waste generated

⁴⁰ This equates to roughly 4 to 5 PV modules.

by a residential source and composed primarily of materials found in the wastes generated by consumers in their homes. Specifically, the hazardous waste regulations exempt household hazardous waste from regulation.

At the time of this report, neither the Hawai'i Department of Health nor the U.S. EPA has determined whether PV modules that are removed from a residential structure meet the conditions for the household hazardous waste exclusion. If they are deemed to be HHW, residential PV modules could technically be discarded but not directly to municipal solid waste landfill. Instead, in Hawai'i, residential modules would be taken by the homeowner to a metals salvaging facility which would then shred the modules along with other metal-containing material streams to produce a metals stream (sent to off-island metals recyclers) and a refuse stream (transported to landfill). The refuse stream will contain unwanted but unavoidable residual metals from the PV modules. In this case, the only way to avoid the shredding of residential PV modules in Hawai'i is through legislative action (e.g., similar to that which banned the landfilling of lead acid batteries⁴¹).

Although not allowed in Hawai'i at H-Power, incineration of PV modules is possible and has been pursued in small amounts (see Appendix, Communications C9). This process requires specialized reactors that reach extremely high temperatures, long burn times, and emission scrubbers to keep emissions below regulated levels (see Appendix, Communications C10). As these processes use specialized expensive equipment, they are not expected to be installed in Hawai'i. Incineration of PV modules at H-Power could cause serious damage to their boilers and produce unacceptable gas emissions. Moreover, the metals embedded within the PV modules would end up in the ash that is ultimately sent to landfill. For these reasons, PV modules are not accepted at H-Power.

PV modules – recycling. The two main pathways for recycling PV modules are reuse (i.e., redeployment for continued use, particularly in low-income regions or applications where the lower power output of the modules is acceptable) or energy and chemical-intensive treatments (i.e., recovery and purification of the underlying elements for subsequent use in the manufacture of new modules or other products).

The reuse of used PV modules is considered superior to materials and energy recovery in the waste hierarchy, a concept similar to that applied to Waste Electrical and Electronic Equipment⁴² (WEEE). In practice, however, the reuse of PV modules has not been commonly used as an end-of-life option [127]. In particular, the secondary market has not yet gained traction in Hawai'i or the United States, in part because it requires substantial regulatory considerations such as regulation of electrical grid interconnection and examination of fire, building, and electrical codes

⁴¹ HI Rev Stat § 342I-1 (2013).

⁴² Directive 2012/19/EU of the European Parliament and of the Council of 4 July 2012 on waste electrical and electronic equipment (WEEE).

when planning for solar PV module reuse [128]. Moreover, policies that define reuse requirements have yet to be developed. These and the appropriate regulatory considerations will have to be developed before reuse is a viable option in Hawai'i.

The recycling of decommissioned PV modules can recover high-value materials (i.e., silicon, indium, silver, tellurium, copper, and aluminum [116]) that can then be reused in domestic manufacturing [129] to both assuage international demand for raw materials, either in the same industry or even new markets [122, 130] and to mitigate concerns about PV supply chain vulnerabilities [129]. Recycling can also mitigate legitimate serious environmental impacts associated with direct incineration or landfilling. For example, the fabrication of new PV modules using material recycled from one ton of discarded c-Si PV modules can reduce, by a factor of two, the Global warming potential (GWP) impact associated with the production of the same number of PV modules from primary materials [131].

Although judged technologically feasible, the long-term implementation of recycling technologies in the U.S. will nonetheless require careful forethought, technical design, investment, and sound business models [15, 132]. Recycling also faces competition from the low cost of landfilling (1 to 2 dollars compared to 20 to 30 dollars per PV module to recycle [102]). Moreover, the PV module recycling industry in the U.S. is relatively young, transient, and unprofitable owing to a lack of high value in the recoverable metals/materials [131]. Although there is some movement by PV module manufacturers⁴³ to develop in-house recycling facilities, as well as efforts to require manufacturers to provide take back programs⁴⁴, these are yet to be implemented and industry pushback is expected [133]. For example, only one U.S. manufacture⁴⁵ has developed in-house recycling capabilities and those are limited to their own thin film cadmium telluride modules [123, 133] – modules that do not yet exist in Hawai'i.

Other issues are challenging the PV module recycling industry. Recycling technology requires the application of complex energy and/or chemically intensive physical separation, thermal treatment, and chemical treatment processes to recover the main components (glass, silicon (Si), and aluminum (Al)) along with less concentrated but still valuable elements such as silver (Ag) and copper (Cu) [11, 12, 20, 116, 134] (Figure 46). The cost of these processes creates significant economic hurdles to the recovery and reuse of materials recycled from PV modules [135, 136]. Moreover, the quantities of recyclable elements will vary across PV module type. Older PV modules, for example, will have greater concentrations of elements such as lead in solders and hexavalent chromium (Cr^{+6}) in coatings. By contrast, newer thin film technology (i.e., CdTe, CIGS, GaAs) modules will have greater amounts of cadmium, arsenic, copper, telluride, and/or selenium [15]. Consequently, qualified recycling processes will have to be tailored to a specific

⁴³ First Solar, <https://www.firstsolar.com>.

⁴⁴ Washington State, for example, has created a stewardship program that requires every PV module supplier to submit a recycling plan by July 2022. <https://app.leg.wa.gov/rcw/default.aspx?cite=70A.510.010>.

⁴⁵ First Solar <https://www.firstsolar.com>.

type or brand of PV module, further complicating the challenge of salvagers or contractors in Hawai'i to find off-island recyclers.

While the implementation of recycling technologies and facilities in Hawai'i is permissible under a hazardous waste management permit [see Chapters 11-264.1 and 11-270.1, HAR], these processes are energy intensive, and will require significant management of concentrated hazardous chemicals (shipping, transport, storage, waste treatment) [17], and will suffer relatively higher operations costs (than their mainland counterparts) owing to a lack of volume. For these reasons, the development of comprehensive recycling plants in Hawai'i is not expected or recommended.

That being said, opportunities do exist for partial (pre-processing) recycling in Hawai'i. Specifically, separation of the frame and junction box from the PV module before disposal of the underlying solar cell to mainland landfill, reuse, or recycling companies. The recycling of the frame and disposal of the junction box would then be managed through existing pathways for metals recycling and disposal of electronic waste. These steps would not only increase shipping efficiency by reducing the weight and volume of PV module being shipped to off-island recycling centers but would also provide a small income stream to island recyclers through the sale of scrap aluminum. However, the separation of the junction box requires only the simple step of disconnection, detaching the frame from the solar cell requires specialized mechanical equipment designed to carefully break the sealant that cements the frame to the glass and backing sheet. Without this equipment, frame removal will often cause breakage of the overlaying glass panel and complicate shipment to mainland recyclers. Finally, although the DOH is currently requesting a modification, the detachment of the frame is currently a regulated operation that would require a hazardous waste permit [see Chapters 11-264.1 and 11-270.1, HAR] (see Appendix, Communications C11).

PV ancillary components – collection. In Hawai'i, PV module mounting structures and cabling are not classified as hazardous waste and can therefore be collected and stored as per usual pathways used by island salvagers. By contrast, in Hawai'i, PV inverters are managed as universal waste⁴⁶. This allows island-based recyclers/salvagers to ship collected PV inverters off the island for recycling or hazardous waste disposal without a uniform hazardous waste manifest⁴⁷. The reduced obligations of the universal waste regulations offer cost savings compared with full hazardous waste regulation. Modules can be sent for recycling without using a uniform hazardous waste manifest and handlers can store the modules for up to a year to collect enough to make shipping them more economical. Under this provision and due to the need to comply with the specific requirements associated with each waste stream, PV inverters must be collected and

⁴⁶ See chapter 11-273.1, HAR.

⁴⁷ See chapter 11-273.1, HAR.

transported separately as universal waste electronic items⁴⁸. Specifically, each PV inverter, container, or pallet containing a PV inverter must be labeled (or marked) clearly⁴⁹.

Universal waste storage requirements for collected PV inverters are performance-based and do not specify how they must be stored in order to prevent their breakage and concomitant release of hazardous materials. During collection, however, universal waste handlers are required to immediately clean up any PV inverter constituent(s) if the component is accidentally or unintentionally broken. Broken pieces must be cleaned up and containerized as to minimize the potential release. Collection containers must be structurally sound and prevent releases under reasonably unforeseeable conditions. Under universal waste regulations, island-based recyclers/salvagers are allowed to collect, transport, and consolidate PV inverters⁵⁰ without a permit but in doing so they must be contained in a manner that prevents their breakage and release of any hazardous material to the environment. While shipping does not require the EPA ID number because it does not require the uniform hazardous waste manifest, a large quantity handler of universal waste must notify and obtain an EPA ID number. This is based on the total accumulation of all types of universal waste (> 5000 kg at any time).

PV ancillary components – disposal. Similar to PV modules, the two principal methods to dispose of PV ancillary components are incineration and landfill. However, neither method is practical in Hawai'i. As cabling and mounting structures are readily recycled, there is no need for their disposal by these two pathways. Moreover, inverters, which meet the definition of electronic item universal waste⁵¹ cannot be disposed of via incineration or landfill (see Appendix, Communications C12).

PV ancillary components – recycling. As with PV modules, the two main pathways for recycling PV ancillary components are reuse (i.e., redeployment for continued use) and treatment (i.e., recovery and purification of the underlying elements for subsequent use in the manufacture of new PV modules or other products). While PV mounting structures and PV cabling are not generally reused⁵², their underlying steel, aluminum, and copper materials are commonly recycled. The amount of waste steel, aluminum, or copper from PV mounting structures and cabling is relatively low compared to annual amounts processed (from all other sources) by salvagers/recyclers in

⁴⁸ See 40 CFR section 273.13(g)(4)(ii), as incorporated and amended in chapter 11-273.1, HAR, which allows inverters to be treated as an electronic item.

⁴⁹ With one of the following phrases: “Universal Waste—electronic item(s),” “Waste electronic item(s),” or “Used electronic item(s).” [40 CFR section 273.14(g) and 273.34(g), as incorporated and amended in chapter 11-273.1, HAR].

⁵⁰ Including interisland shipping to centralized collection sites and off island shipping.

⁵¹ See definition on page 10 of chapter 11-273.1, HAR, guidebook with track changes at <https://health.hawaii.gov/shwb/hwrules/>

⁵² While in some cases mounting structures could be reused, they are usually sized for specific installations and new projects will generally purchase new mounting structures and cables in order to accurately size them to their specific installation.

Hawai'i. As such, the amount of these materials entering the waste stream can be managed by existing salvaging/recycling infrastructure in Hawai'i.

PV inverters contain circuit boards and are classified as electronic item universal waste. Because of this, a hazardous waste treatment permit is required to dismantle an inverter to retrieve and separate the internal circuit boards from the housing unit. Technically, the generator of the inverter can disassemble it to recover the metal casing for recycling and the circuit boards for disposal, but disassembly by a site collecting from other generators is not allowed. The preferred option is to ship the entire inverter to off-island qualified recycling centers⁵³.

Energy Storage Systems

In Hawai'i, there is a growing demand for electric vehicles and energy storage systems. As such, there will be a significant need for either disposal or recycling options by the end of this decade [68]. This demand will mirror similar demands in other regions. For example, Call2Recycle, an organization that supports the collection of lithium-ion and other batteries for recycling, saw a 36% year-over-year increase in its lithium-ion battery collection volume in 2019 [137]. In China, the number of lithium-ion batteries produced in 2019 alone was 15.722 billion units with that number projected to grow to 25 billion units in 2020 and a total weight of 500,000 tons [68].

The generalized pathway for comprehensive end-of-life treatment applied to clean energy materials was presented in Figure 45. The application to lithium-ion batteries (LIBs) is presented in Figure 47. Steps 1 (collection) and 2 (transport) refer to the collection, storage, and transport of battery waste (i.e., spent LIBs as well as their ancillary components) to recycle/reuse process facilities (whether on-island or off island). Step 3 (dismantling) refers to the sorting, disassembly, and discharging of the collected battery packs or modules. It also refers to the deactivation of the battery cells (isolated from the packs/modules during disassembly) before they are submitted to recycling processes described steps 4 and 5. Step 4 (separation) refers to the use of initial pretreatment steps applied to the battery cells to separate the internal components into two separate but coarse material streams (copper and aluminum foils and a fine powder called "black mass"). Step 5 refers to process operations that further refine the black mass for the recovery of metals (as alloys) and the production of a "slag" by-product. Step 6 refers to further processing of the slag to recover lithium.

⁵³ Shipping does not require the EPA ID number because it does not require the uniform hazardous waste manifest. A large quantity handler of universal waste must notify and obtain an EPA ID number. This is based on the total accumulation of all types of universal waste (> 5000 kg at any time).

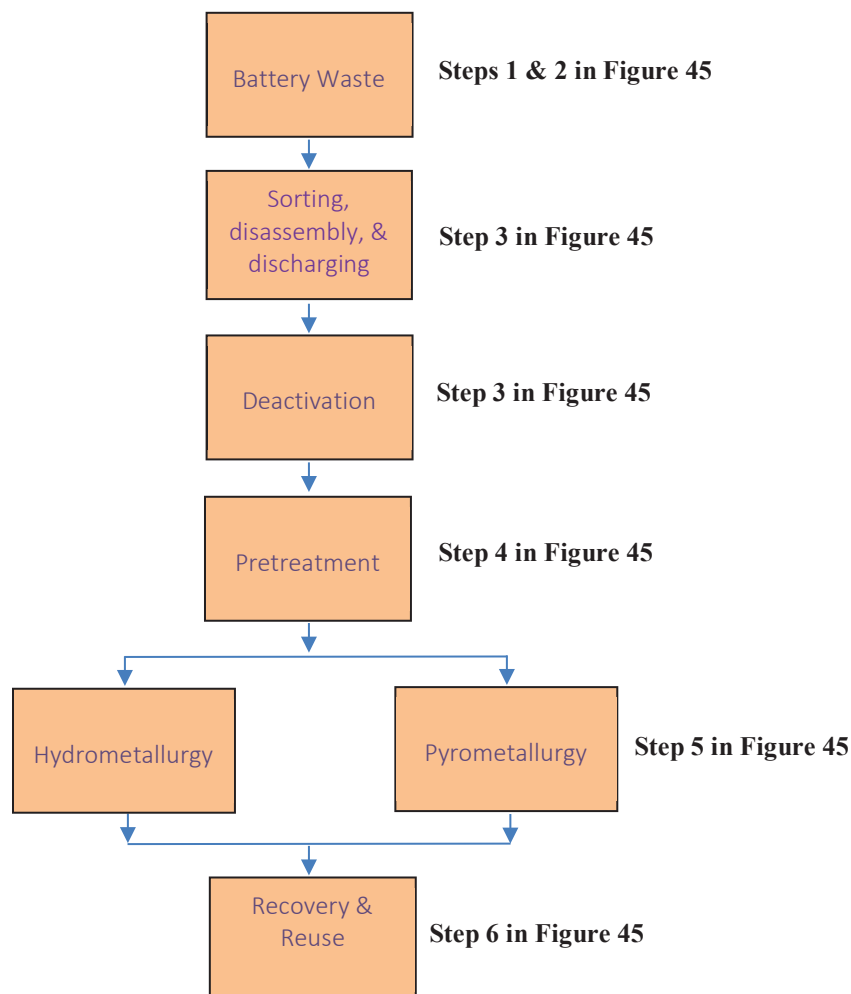
Figure 47. End-of-life management of battery systems.

Batteries – collection. As discussed in section 2 of this report, the predominant EV or energy storage battery used in Hawai'i is lithium-ion. Lithium cells and the batteries that contain them can present chemical (e.g., corrosive or flammable electrolytes) and electrical hazards. The degree of these risks is generally tied to their size and chemistry (e.g., their high energy density and the flammability of the chosen electrolyte). Moreover, the collection of these LIBs is complicated by their weight and hazardous nature. LIBs use organic liquid electrolytes, which are volatile and flammable when operating at high temperatures. The dangerous characteristic of LIB reactivity and ignitability is due to the flammability of their electrolyte due to breakdown of internal polymeric separator or by puncture or breakage. Although infrequent, these events can result in the short-circuiting of the underlying lithium cells⁵⁴ which then causes a thermal runaway – a chain reaction leading to a violent release of stored energy – which result in combustion and the release of toxic fumes [138]. Moreover, thermal runaway reactions can propagate to other batteries or

⁵⁴ Either due to breakdown of internal polymeric separator or by puncture or breakage.

combustible materials nearby, potentially resulting in large scale thermal events with severe consequences [139]. Once ignited, lithium cell and battery fires are extremely difficult to extinguish⁵⁵.

The U.S. EPA has historically encouraged waste handlers to manage LIBs under the universal waste battery classification but they are now recommending end holders to contact the manufacturer, automobile dealer, or company that installed the LIB⁵⁶. The U.S. Department of Transportation (DOT) has issued regulations on the transport of LIBs material under Hazardous Materials Regulations (HMR; 49 C.F.R., Parts 171-180). The DOT regulates the movement of hazardous materials, like lithium batteries, when transported in commerce as in the case of contract waste haulers or commercial recyclers. They also publish a website with a streamline presentation of this information⁵⁷. The HMR applies to any material the DOT determines can pose an unreasonable risk to health, safety, and property when transported in commerce. Lithium-ion batteries, therefore, must conform to all applicable hazardous waste regulations and HMR requirements when offered for transportation or transported by air, highway, rail, or water [139]. In Hawai‘i, lithium-ion batteries are managed as universal waste under Chapter 11-273.1, HAR. Under this provision and due to the need to comply with the specific requirements associated with each waste stream, LIBs must be collected and transported separately as universal waste. Each LIB, container, or pallet containing LIBs must be labeled (or marked) clearly⁵⁸.

The collection begins with the removal of the battery pack or modules from either the frame of the electric vehicle or from the cabinet casing that houses the energy storage system battery and ancillary components. In some scenarios (e.g., manufacturers agree to take back their batteries), the best practice may be to leave the battery packs/modules from energy storage system batteries intact within their housing unit and to ship the entire unit (i.e., local salvagers would not remove the battery packs/modules from the housing unit as a means to recover and recycle the steel or aluminum in the cabinet casing).

Once collected, the removed battery packs and/or modules are transported to regional waste management collection centers where they are stored until transported to qualified (off-island) recycling centers. Local transportation is usually done by a municipal or commercial waste management vehicle, or less commonly, the waste generator transports its waste directly to a facility. Under this scenario, LIB waste should be collected and transported by separate recycling and municipal solid waste trucks. Some areas may also have specialty vehicles such as scrap metal trucks. This is important because currently most vehicles are not designed to safely handle LIBs [140].

⁵⁵ <https://www.cnn.com/2022/01/29/electric-vehicle-fires-are-rare-but-hard-to-fight-heres-why.html>.

⁵⁶ <https://www.epa.gov/recycle/used-lithium-ion-batteries>.

⁵⁷ <https://www.transportation.gov/check-the-box>.

⁵⁸ With one of the following phrases: “Universal Waste—Battery(ies),” “Waste Battery(ies),” or “Used Battery(ies).” [40 CFR section 273.14(a) and 273.34(a), as incorporated and amended in chapter 11-273.1, HAR].

During transport to recycling centers, LIBs must be packaged per the regulations found in 49 CFR 173.185 *Lithium cells and batteries*, which include requirements for inner packaging, strong rigid outer packaging and protection against short circuits⁵⁹ [139]. The labeling must include labels declaring universal waste, cargo-only planes, and lithium-ion batteries (Figure 48). As damaged LIBs present a significant risk during shipment, they must be transported separately and anyone organizing their shipment must separate and identify those batteries that pose an *increased* risk of producing a dangerous evolution of heat, fire, and short-circuiting.

Figure 48. End-of-life management of battery systems.



Even though they have been initially discharged, LIBs still contain enough internal energy to remain vulnerable to short-circuiting vents that can lead to thermal runaway reactions that generate fires and explosions [141]. Storage facilities should, therefore, have fire suppression systems that are designed to extinguish LIB fires. LIBs burn hotter, faster, and require far more water than typically required to reach final extinguishment and the batteries can re-ignite hours or even days after the fire is initially controlled, leaving salvage yards, repair shops, and others at risk. These fire suppression systems need to address the high energy density of LIBs, the toxic gasses produced during fires, and the fact that they can reignite for days. Moreover, damaged batteries must be separated during collection and storage even though there are currently no clear definitions of what constitutes a damaged battery, nor how they should be stored other than to keep them away from buildings or other flammable materials.

Batteries – disposal. As with PV modules, the two possible disposal pathways for LIBs are landfill and incineration. Landfilling of LIBs, however, is a concern⁶⁰. When penetrated, waste LIBs will release hazardous chemicals and produce a toxic leachate that contaminates underground water. They can also spontaneously ignite and create underground fires that release toxic gasses (e.g., fluoride gas) [142], create large sink holes, and/or burn through the underlying plastic landfill liner that protects groundwater [143]. Although landfilling of LIBs is currently unregulated, various

⁵⁹ See § 173.185(b).

⁶⁰ See U.S. EPA FAQ at <https://www.epa.gov/recycle/frequent-questions-lithium-ion-batteries>.

States are introducing bills that would restrict landfill disposal and place more responsibility on the manufacturer. For example, the Responsible Battery Recycling Act was recently proposed in California's legislature (Senate Bill 1215 and Assembly Bill 2440). These measures would create a collection and recycling program in which consumers would require companies that manufacture lithium-ion batteries and battery-embedded products sold in California to develop, finance, and implement this program in collaboration with CalRecycle⁶¹. In Hawai'i, electric vehicle and energy storage system lithium-ion batteries are not accepted at landfill sites and, when found, are sent back to recycling centers.

In Hawai'i, commercial LIBs are also banned from incineration at H-Power. While incineration is possible, like PV modules, it can only be done at a facility designed to process LIB waste. At such facilities, best practices require high heat intensity, the use of scrubbers to process the exit gasses, and recovery techniques applied to the ash to recover metals. Incineration is capital intensive in part due to high energy requirements and complicated off-gas treatment mechanisms. As such, LIB recycling incineration is largely conducted as a pretreatment method in more complex recycling pathways, mostly to get rid of carbon-containing material and organic components to simplify and improve the hydrometallurgical recycling of metals [144, 145]. For example, in the Sony-Sumitomo process LIBs are first incinerated at 1,000°C [146]. The organics, lithium, and fluoride in the batteries are lost as fly ash and are removed from the flue by a scrubbing system. The metal residue obtained in the furnace is processed hydrometallurgically to recover cobalt. No lithium is recovered, however.

Batteries – recycling. A general overview of recycling pathways is presented in Figure 49 for both EV and energy storage system LIBs [138]. The complexity of these pathways underscores the reality that electric vehicle and energy storage system batteries are not designed to be recycled or reused. The cells that make up the battery are not designed with material recovery in mind. Instead, they're manufactured to produce energy for a long time, and as cheaply as possible [147]. Given that landfilling and direct incineration of LIBs are banned in Hawai'i and that stockpiling of LIB waste is potentially unsafe and environmentally undesirable, the preferred end-of-life options is to recycle when direct repair and re-use of an LIB pack or module is not possible [148]. Under this scenario, the ideal end location of a LIB would be a dedicated battery recycler: a facility that is designed to receive LIBs and to recover purified materials streams for use in the manufacturing of new batteries [140].

Although improving⁶², the LIB recycling industry today is neither sufficiently mature nor reliable to provide Hawai'i salvagers with consistently reliable mainland partners and, in particular, a single one-stop shop that can take all types of LIBs. Currently there are only a few significant

⁶¹ The California state agency that oversees waste management, recycling, and waste reduction programs.

⁶² See, for example, <https://spectrum.ieee.org/lithiumion-battery-recycling-finally-takes-off-in-north-america-and-europe>.

companies/organizations seriously addressing recycling LIBs⁶³ and most of these are only startups⁶⁴ [149]. These efforts are in their infancy, only address their products, and can only process a fraction of their target market [150]. Likewise, other companies that are emerging in the specialized field of repair, refurbish, and resell are targeting specific brands and models⁶⁵. The complexity of lithium-ion batteries, with their varying active and inactive material chemistries, is undermining the development of a single robust recycling process for all makes and brands of LIBs [151]. Adding to this dilemma is the fact that the only federal policy in the U.S. regarding battery recycling is the Battery Act of 1996, which primarily focuses on facilitating the recycling of nickel–cadmium (Ni–Cd) and small sealed lead-acid (SSLA) rechargeable batteries, as well as phasing out the use of mercury in batteries. Only four states, namely California⁶⁶, Minnesota⁶⁷, New York⁶⁸ and Puerto Rico⁶⁹, have introduced regulations for the collection and recycling of LIBs.

⁶³ See, for example, Redwood Materials (Reno, Nevada), Li-Cycle (Canada), American Battery Technology Company, Ascend Elements, KURL Technology Group, Aceleron (UK), ReCell Center (DOE research consortium), Global Battery Alliance.

⁶⁴ See for example, Redwood Materials. <https://www.redwoodmaterials.com/>.

⁶⁵ See for example, Bumblebee Batteries which specializes in Honda and Honda Hybrids. <https://bumblebeebatteries.com/>.

⁶⁶ California Rechargeable Battery Recycling Act of 2006 (AB 1125).

⁶⁷ Minnesota's Rechargeable Battery and Products Law.

⁶⁸ Laws of New York chapter 562, 2010.

⁶⁹ Puerto Rico Electronics Recycling and Disposal Promotion Act, 2012.

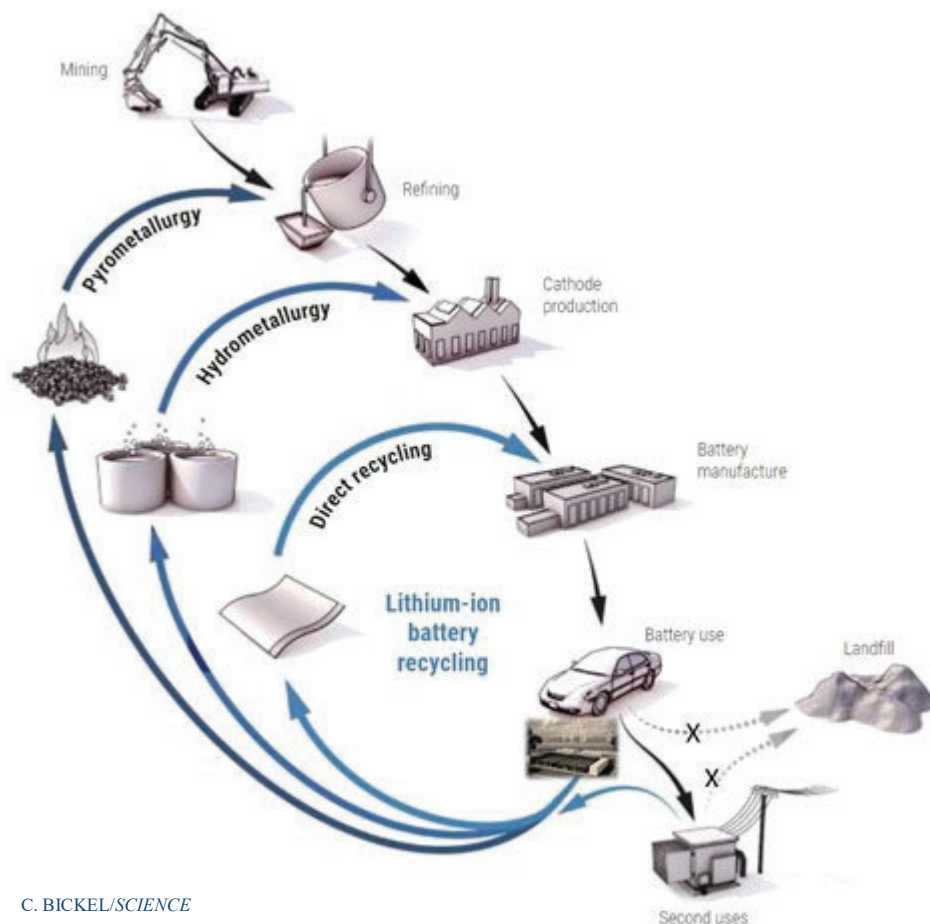
Figure 49. Recycle loops for recycling LIBs.

The first step at any recycling facility is sorting the LIBs by manufacturer and chemistry. Sorting is required because the variety of cell chemistries and designs leads to challenges for recycling processes. As discussed above, recycling companies are often specialized in particular battery chemistry types since mixing them has a negative influence on product quality [152]. As such, not every cell chemistry can be recycled at a given recycling plant. After sorting, the lithium-ion battery packs or modules can be manually dismantled to recover the steel, copper, aluminum, selected plastics, and precious metals from the housing, cable harness, cooling system, or other electronic parts. Although manual dismantling is a relatively simple method, it is associated with low efficiency, harsh environments, severe safety hazards and requires a large workforce. Nissan's rectangular Leaf battery module, for example can take two hours to dismantle while Tesla's battery cells are unique not only for their cylindrical shape but also for the almost indestructible polyurethane cement that holds them together [138]. There are many safety hazards during the disassembly process; it must be carried out in a dry environment and workers need to wear personal protective equipment (PPE) throughout the process. Due to the lack of standardization across

manufactures, the battery packs or modules must be manually disassembled by trained staff with special tools [153].

Because of these challenges, modern recycling facilities prefer to standardize the recycling process by avoiding manual disassembly in favor of more sophisticated recycling technologies. These often begin with a deactivation step to remove the LIBs stored energy and to prevent a surprise thermal event. A common deactivation step is pyrolysis [152] although the electrolyte can also be frozen to prevent the unwanted thermal runaway reactions from occurring during the follow-on processing steps [152]. This step greatly reduces the risk of fires⁷⁰. Once deactivated, the LIB is then subjected to mechanical pretreatment (i.e., shredding⁷¹ or crushing) to produce a black powder from which the valuable fractions (iron (Fe), Cu and Al alloys) are separated by sieving [154]. Thereafter, battery recycling facilities mainly deploy various versions of pyrometallurgy or hydrometallurgy to recover metals and lithium from the black matter. Specifically, the powder is either smelted (pyrometallurgy⁷² [148, 155]) or dissolved in acid (hydrometallurgy⁷³ [155]) to recover valuable compounds, rich in Li, Co, Ni, Mn, etc. [152]. Some facilities will use multiple methods to maximize material recovery. HNEI analysts have held initial discussions with two Nevada recycling start-up companies. As these are new endeavors, processes for recycling are closely held. However, it is known that one of these companies plans to focus on hydrometallurgy while the other plans to focus on pyrometallurgy.

Battery ancillary components – collection. As discussed above, the battery ancillary components are part of the assembly pack or module that comes with the electric vehicle or energy storage system. No additional considerations are needed for the collection of battery ancillary components as they will be collected along with the battery packs or modules.

Battery ancillary components – disposal. In some cases, the battery ancillary components describe above can be disposed of through existing pathways. However, to do so, most will need to be removed during a disassembly step. Given that in Hawai'i the probability will be to ship electric vehicle and energy storage LIBs to off-island recycling centers outright, no added considerations are needed concerning their disposal.

⁷⁰ See, for example, <https://www.popsci.com/energy/lithium-ion-batteries-recycling-fire/>.

⁷¹ See, for example, <https://www.batteryrecyclersofamerica.com/lithium-iron-phosphate-battery-recycling/>

⁷² Pyrometallurgy (e.g., smelting) is a process that heats material in a high temperature furnace to extract metals. Units run as high as 1,500°C and the process can recover cobalt, nickel, and copper, but not lithium or aluminum, which end up in a residue called slag. The high heat required causes this process to be energy intensive. An alloy of cobalt, nickel, and copper is the final product, along with residual gases and slag. The resulting alloy requires more processing to extract individual minerals to be used as components in the battery supply chain.

⁷³ Hydrometallurgy is a chemical leaching process for extracting and separating cathode metals. The process can run below 100°C, requires less energy than pyrometallurgy, and recovers lithium in addition to the other metals recovered by pyrometallurgy. The process uses a liquid bath to extract the metal from batteries, which can be composed of caustic reagents such as hydrochloric, nitric, or sulfuric acids. Hydrometallurgy generally has lower capital costs than pyrometallurgy.

Battery ancillary components – recycle. Battery ancillary components are largely electronic wastes that can, if recovered by manual disassembly, be processed through pre-existing recycling pathways. Otherwise, they are simply processed at the off-island recycling facilities.

Solar Hot Water Systems

Solar hot water panels. In Hawai'i, solar thermal panels are excluded from the definition of solar (PV) modules under the universal waste (UW) rules – the definition of a solar panel does not include solar thermal panels that do not contain photovoltaic cells. As such, disposal of solar water heater panels can be executed through processes for white goods. Recyclable metals (e.g., copper, aluminum) can be stripped and the remainder sent to landfill or incineration along established pathways. The volumes, overall, are small compared the material streams of home appliances, instrumentation, cars, and general construction waste (glass, plastic, wood...).

Solar hot water ancillary components. Ancillary components to solar water heaters are not classified as hazardous and can be processed as white goods. The volumes, overall, are small compared to the material streams of home appliances, instrumentation, cars, and general construction waste (glass, plastic, wood...).

CONSIDERATIONS FOR DISPOSAL OR RECYCLING

This section provides an evaluation of the costs associated with the collection, disposal, and recycling of clean energy materials, as well as a discussion on how these costs could be covered.

Overview

While there is no “panacea,” the combination of solar PV and energy storage is generally accepted by the scientific consensus to be one of the most powerful and effective technologies to decarbonize the economy and energy sectors in response to the global climate emergency. Private market participants and public policymakers at the local, state, and national levels are choosing solar PV and energy storage as a key component of plans to address climate change and reduce greenhouse gas emissions⁷⁴. Solar PV and energy storage at all scales provide significant benefits including but not limited to greenhouse gas emissions reduction, lowering energy costs for consumers and businesses, providing reliable and resilient power, creating jobs, and driving innovation and investment. Despite these benefits, the end-of-life management of solar PV modules and energy storage batteries is a key cost and consideration that must be managed. Manufacturing and end-of-life treatment creates health and environmental concerns [6, 135, 156, 157]. Moreover, production is placing a strain on the mining of key elements that go into their manufacture [129, 130]. The same concerns exist for the LIBs in energy storage systems [64, 158, 159]. Despite these concerns, multiple stakeholders including those from industry, are working to develop viable solutions. In Hawai'i, the key question remains how best in Hawai'i to fund the disposal and recycling of these concerning clean energy materials.



The key question remains how best to fund the disposal and recycle of these concerning clean energy materials.

Despite calls and promise for the recycling of their underlying materials and elements [21, 160], PV modules and lithium-ion batteries face legitimate hurdles with respect to recycling. For example, while the ancillary components (cables, mounting structures, inverters, electronic items, battery management systems...etc.) all have pre-established recycle pathways that generally produce modest revenue, the recycling pathways for PV modules and lithium-ion batteries are currently undependable and cost incurring⁷⁵. For example, current technology, infrastructure⁷⁶, and processes associated with recycling PV modules do not support profitable recovery of cash materials [129]. With respect to LIBs, it is currently less expensive to mine lithium than to recycle

⁷⁴ See IEA Report at <https://www.iea.org/reports/net-zero-by-2050>.

⁷⁵ Assumes the cost of shipping from Hawai'i will continue to outpace any revenue from mainland recyclers.

⁷⁶ See, for example, the following trade article on Lithium battery recycling at <https://www.wastedive.com/news/lithium-ion-battery-industry-recycle-biden-dpa-russia/623042/>.

it⁷⁷, and there remains a lack of large-scale cheap methods to recycle LIBs⁷⁸, and their recycling does not benefit from the value of scrap copper (cables) and steel (mounting structures), which provide revenue streams from PV module decommission [161].

For these and other reasons, expectations for the emergence of the recycling industry that pays waste generators for PV modules as well as electric vehicle and energy storage system LIB batteries are challenged for the foreseeable future⁷⁹. And while there are sound reasons to believe this situation will eventually shift for LIBs, for example, the scarcity and hence future expected value of lithium will increase as more LIBs are made as well the geopolitical positioning of nations like the U.S. to subsidize the procurement of local sources of lithium, these will take some time. Moreover, the same outcome should not so readily be expected for PV panels⁸⁰. For example, Figure 50 shows a few photos of illegally dumped panels and inverters taken by a mainland recycler who recently toured the islands to revisit past installations (of his). Moreover, this same recycler was unwilling to share more extensive photographs of additional dumped PV panels as he is “considering a lawsuit against the company that previously had the panels.” Consequently, it is recommended to consider that the costs associated with environmentally responsible disposal options will, in the near to mid-term foreseeable future, encourage cheaper, more accessible, and less environmentally sound disposal options. Moreover, in Hawai'i, the price of shipping will always continue to impose added costs that undermine the emergence of a pay-for-waste recycling industry on the mainland.

⁷⁷ See New York Times article on the upcoming lithium-ion gold rush.

<https://www.nytimes.com/2021/05/06/business/lithium-mining-race.html>.

⁷⁸ See, for example, the article *Lithium batteries big unanswered question* at

<https://www.bbc.com/future/article/20220105-lithium-batteries-big-unanswered-question>.

⁷⁹ Assumes the costs of operating the recycling processes will remain greater than the income received from the sale of materials recovered and purified from the PV modules and LIBs.

⁸⁰ See LA Times article detailing the landfill disposal problem in California at

<https://www.latimes.com/business/story/2022-07-14/california-rooftop-solar-pv-panels-recycling-danger>.

Figure 50. Images of dumped PV panels and inverters.



In discussions with stakeholders helping to prepare this report, three options have been identified that each partially address the costs of disposal and recycling: Waste Generator Responsibility (WGR), Expanded Producer Responsibility (EPR), and State Assisted Recycle (SAR). Under WGR, the generator of the waste would bear the full cost of off-island disposal and recycling. Under EPR, the manufacturers, distributors, or other responsible parties would be physically and financially responsible for the collection and recycling of their products at their end-of-life stage [162]. Under SAR, the State of Hawai‘i would assist salvagers, contractors, and the counties with the costs of collection and off-island disposal and recycling of PV modules and lithium-ion batteries⁸¹. The relative advantages and disadvantages of each option are now discussed for both PV modules and lithium-ion batteries.

PV Modules

Basic cost. The price of treating PV modules can vary dramatically with region and choice of treatment method. Current costs of landfilling on the mainland are around \$1.38 per module while the average recycling cost is \$28⁸² per PV module [163]. In addition, the cost of transporting PV modules from Hawai‘i to Reno (door to door) is estimated to be between \$15 (40”HC) and \$32 (20”Std) depending upon the container selected (see Appendix, Communications C13). In Europe, by contrast, the price of recycling is currently 75¢ for a 250 W module of 10 kg mass. The significantly lower cost in Europe is attributed to higher volumes, the learning effect, and

⁸¹ This could be modelled, for example, after the Glass Advance Disposal Fee program or less so after the Hawai‘i Deposit Beverage Container Program.

⁸² This excludes the cost of transport from Hawai‘i to the mainland.

significant government investment⁸³ [163]. Given the lack of aggressive government policy and legislation, these lower costs for recycling are not expected to occur in the U.S. or Asia in the foreseeable future.

Waste generator responsibility. Under this scenario, those responsible for generating the waste are required to arrange for and pay the full cost of transport and treatment at off-island disposal/recycling centers. In practice, at residential and commercial scale homeowners would contract PV installers or contractors to remove and arrange for the off-island transport of their PV modules to landfill disposal or industrial recycling. At the utility-scale the independent power producer (IPP) would be expected to manage the disassembly and transport costs. As discussed above, the costs to the waste generator will vary depending upon the choice of landfill or recycling for end-of-life treatment. In the event that off-island landfill options are ultimately banned, the waste generator in Hawai'i would then have to bear the higher cost of recycling in addition to shipping. On average, using today's recycling costs (see Appendix, Communications C14), this would amount in Hawai'i to approximately \$60 per module not including the labor charge of the contractor/installer to remove the modules (see Appendix, Communications C15). For the average size of a 20-module installation, the cost of removal, transport, and recycle could reach as high as \$3,200⁸⁴. If landfilling continues in the U.S. or Asia, then the cost of recycling could be avoided and under this scenario, the cost of removal and transport would decrease to approximately \$2,000. In either case, both options present end of use costs to the waste generator. At the utility-scale, the expectation is that the Power Purchase Agreements (PPA) should have included language requiring the Independent Power Producers (IPP) to bear the full costs of their de-installation and off-island removal. Future work should review each PPA in depth to review the burden of enforcement.

Expanded producer responsibility. Under this scenario, the manufacturer, distributor, or some other responsible party, is required to manage the end-of-life treatment of their PV module product. Pioneered in Europe through the WEEE Directive, the EPR act requires producers of PV modules to ensure their take-back and recycling – including the related administration, reporting and financing – of their products within the countries of the EU. In Europe, any violation of the WEEE rules may incur fines or an interdiction of commerce. Through this obligation, the industry can take greater responsibility and builds in the cost of collection and end-of-life treatment of their products into the up-front cost paid by the consumers. Finally, each EU Member State defines individually how PV modules will be covered by their national WEEE law.

Currently, there is no analogous federal program in the U.S. although some States are moving in this direction. In 2017, for example, Washington state became the first in the U.S. to pass a bill

⁸³ In the EU, for example, solar cells manufacturers are bound by law to fulfil specific legal requirements and recycling standards. This has led to significant advancements in the recycling industry.

⁸⁴ An estimate of \$2,000 to uninstall and take down modules plus 20x60\$.

establishing an extended producer responsibility (EPR) program for solar modules⁸⁵ [164]. The law will require, starting in July 2023, manufacturers to fund the collection and recycling of the modules. In California, the Department of Resources Recycling and Recovery (CalRecycle) has considered adding solar modules to its electronics recycling program [164]. In particular, the department is working with other branches of state government to draft a paper, expected to be released this year, on the end-of-life management of PV modules [164].

Overall, Hawai'i remains somewhat isolated with respect to implementing similar EPR laws for PV modules. Hawai'i's market share is comparatively small and consequently unlikely to exert significant influence over manufacturers of PV modules. Moreover, the majority of module manufacturers are based in countries outside the jurisdiction of U.S. law, complicating legal remedies for noncompliance with any EPR law. In this scenario, the most likely way for Hawai'i to enforce EPR compliance (beyond that which is imposed by California or the larger United States) would be to disallow the purchase of PV modules from manufacturers that decline to participate. This step could impact the ability of installers and contractors to offer their clients the full range of price and product choice and potentially lead to higher prices. For these reasons, the full success of EPR laws in Hawai'i is tied to their effective execution in the States of California, Washington, or even the larger U.S.

State assisted recycle. Under this scenario, the waste generator (e.g., salvagers or contractors) who arrange for the collection and transport of PV modules to mainland disposal or recycle sites would receive some form of financial reimbursement from the State. The question of how the State would raise and distribute the revenue is complicated by issues of equity, practicality, and administrative capacity. Over the course of speaking with stakeholders spread over staff in the county refuse divisions, private salvagers, mainland recyclers, and county recycle coordinators, two principle options surfaced. In the first, the installer or contractor would add a surcharge per module to be paid at the time of purchase⁸⁶ which would then be transferred to some form of a State Assisted Recycle program. In the second, the homeowner would pay a surcharge per watt generated over the lifetime use of the module. These funds would be transferred to the State Assisted Recycle program⁸⁷. In either case, the collected funds would be used to help subsidize the costs of recycling. For example, the funds could be transferred to county programs that manage recycling programs and contract salvagers for the disposal of abandoned vehicles and other wastes⁸⁸.

The first option, an Advanced Disposal Fee, represents a pay-forward mechanism in which fees collected from purchases today are directly used to cover the costs of modules thrown away today.

⁸⁵ <https://www.eesi.org/articles/view/washington-state-tackles-solar-panel-waste-the-dirty-side-of-clean-tech>. Accessed 6/21/2022.

⁸⁶ Termed, for example, an *Advanced Disposal Fee*.

⁸⁷ In a manner, perhaps, similar to how the Hawai'i Energy program is funded.

⁸⁸ Such as those with already exist to underwrite the cost of disposal of abandoned cars.

While there is no direct connection between a fee collected at the time of purchase and its specific disposal/recycle at a later date, there is no other viable alternative because of the lag time to its disposal is over twenty years. Without such assistance the number of modules currently dumped at Hawai'i landfills is expected to continue and increase (see Appendix, Communications C16).

The second option collects the funds in very small monthly increments. This pay as its used concept was recently proposed by scientists at NREL for the United States starting in 2021 [163]. The authors assumed an installation of 25 GW in 2021, a 25:1 ratio of newly installed to recycled modules, an average module rating of 350 W per module, and a recycling cost of \$18 per module. Spreading the cost across 25 GW, the authors calculated a “fee” of 0.2 cents per watt or approximately \$0.78 per 350 Watt module and just over \$1 per commercial scale module. The authors further postulated that such a fee system would increase the cost of a 7 kW residential project by only \$15, a commercial scale project by only a few hundred to a few thousand dollars, and a utility-scale project between tens of thousands to a million dollars for a gigawatt scale facility [163]. Finally, the authors pointed out that although the ratio of new modules being recycled will decrease with time, the cost of recycling modules in the U.S. should significantly decrease and thus offset the greater number of modules being recycled⁸⁹.

Averaging the surcharge over the lifetime of the PV module has the advantage of keeping the surcharge low while still ensuring that sufficient funds are raised to cover present recycling costs. For example, the number of PV modules currently being installed are high relative to the number of PV modules that would be shipped off island for recycling. As such, only a small surcharge per watt produced per module is needed to cover the costs of transporting and recycling a small number of PV modules. With time, as the number of PV modules to be disposed and recycled increases, the cost of recycling can be expected to decrease significantly [102]. Unfortunately, this savings is only for the recycling portion. Shipping and labor costs, which are included as total cost for recycling will not likely decrease. In summary, more than 50% of \$60/module cost is estimated to be shipping and labor is not included. As such, the relatively small surcharge per watt produced per module will may still not be enough to cover the decreased cost off-island disposal.

Lithium-ion Batteries

Basics cost. A recent study by the Electric Power Research Institute presented a cost of \$1 per lb. (\$2.20 per kg) as the recycling cost of lithium-ion chemistry batteries⁹⁰ [165]. This cost estimate included the batteries being delivered to the recycling facility, the labor cost of module disassembly as well as offsets for the value of the metals recovered from the recycling process. Although this study assumed that metal racks inherent to the battery packs/modules could be

⁸⁹ This assumes the lower recycle costs is predicated on high participation in recycling and thus the production of sufficient volume of PV modules being recycled so as to support the learning curve of the U.S.-based recycling industry.

⁹⁰ e.g., NMC, NCA, LMO, LFP, LTO.

recycled as scrap metal, the amount recovered from recycling the scrap metal (~8¢ per lb.) was considered sufficient to offset the cost of their (i.e., copper and steel) transport to a metal(s) recycler but insufficient to significantly offset the cost of the battery recycle. Also, the cost of recycling the battery management system units was neglected (i.e., the computer components that monitor and operate the battery modules along with the cable connectors can be commonly recycled with the other electronic components in the system). Another report suggest that it costs \$4.50 per pound to recycle a Tesla battery [166]. For context, a typical residential Tesla Powerwall battery weighs 250 lbs. yielding a recycling cost between approximately \$250 and \$1,000. These numbers are, however, fluid changing as the refurbish, reuse, and recycle markets develop.

As with PV modules, the costs of off-island disposal of lithium-ion batteries are both fluid and heavily impacted by shipping costs. In a review of these studies, Slattery et al. unsurprisingly found that the transport cost estimates can vary significantly: from \$0.24 per kg to \$5.51 per kg for a standard distance assumption, yielding an average value of \$1.54 per kg [167]. Reasons for this range include regional differences in fuel and labor costs, as well as different calculation methods. In Hawai'i, the cost to ship LIBs to the mainland (e.g., Reno Nevada where Tesla's Redwood Materials plant is located) costs between \$900 and \$3,000 for a 44" x 48" x 48" size pallet⁹¹. For context, the Model S and Model X Tesla battery dimensions are 68.5 x 30 x 75 cm (L x W x H). This translates to a volume of 5.5 ft³. The volume of the pallet above is 58.5 ft³. If some loss of space is assumed just to shape issues, roughly 10 batteries per pallet can be shipped. As such, some savings could be achieved by bulk shipment as the price for one or multiple LIB's is comparable – the quotes are based on pallet size and not so much on weight.

The above discussion highlights the reality that the cost of recycling lithium-ion batteries is both fluid and a moving target and, in Hawai'i, highly impacted the cost of shipping. That said, long-term prospects for reduced costs or even profit from recovery of materials are being promised [168]. In many lithium-ion batteries, for example, the concentrations of cobalt, nickel, lithium, and manganese exceed the concentrations in natural ores, making spent batteries akin to highly enriched ore [155]. However, routes to profitability are still unclear [169] even as new recycling methods are being developed [140]. Moreover, the widespread implementation of LIB recycling is hampered by recycling inefficiencies, environmental impacts, safety hazards and logistical challenges, such as collection and transportation [170]. A large variety of pack designs and battery chemistries further add to the complexity of recycling [171]. Given the currently rather low number of End-of-Life (EoL) electric vehicle LIBs, recycling costs are still high and profits low, discouraging EV and battery manufacturers from pursuing the effective recycling of retired batteries [172].

⁹¹ For example, uShip (<https://www.uship.com>). This is an online service that facilitates quotes from multiple shippers.

One additional factor not considered is decommissioning costs. While at the utility-scale the cost of decommissioning the installed batteries is the responsibility of the independent power producer⁹², for residential and commercial scale installations the cost of decommissioning will be borne by the owner and generator of the waste LIB. This distinction is key because independent power producers will be more likely to be aware of and to therefore plan for decommissioning costs than your typical homeowner who may find the unexpected costs prohibitively high.

Waste generator responsibility. Under this scenario, those responsible for generating the LIB waste are required to arrange for and pay the full cost of transport to and treatment at off-island disposal/recycling centers. For electric vehicles, this could be the last owner of the vehicle (presumably arranged through the independent mechanic replacing the battery). It could also potentially be the car dealership depending upon the details of any manufacturer backed EPR agreements. In the case of energy storage systems, this translates to residential homeowners or commercial scale business owners contracting battery installers or contractors to remove and arrange off island transport of their lithium-ion batteries. In the case of abandoned or auctioned electric vehicles, the cost burden falls upon the counties and salvagers. At utility-scale, the independent power producer would be expected to bear the full cost⁹³. In those situations, where the IPP declines to honor their commitment, either through insolvency or contractual disagreement, the property owner would bear the costs of clean-up. In those cases where the property owner fails to make payment, the costs will then ultimately fall on the State or counties until the funds can be recouped through enforcement⁹⁴.

As discussed above, the waste generators costs will vary. This variation is not solely a function of classic market competition drivers⁹⁵ but also due to unknown developments in the recycling industry and government regulatory sphere – both of which will have profound impacts upon the costs to recycle. In Hawai'i, the cost of shipping must always be accounted for. For the sake of estimation, however, a typical Tesla car owner in Hawai'i could expect to pay approximately \$15,250⁹⁶ to have their used battery shipped and fully recycled. This number is only an estimate (e.g., the car battery weight is going to vary by the battery capacity and energy density both of which will vary with the manufacturer and car model). The consequences of this high cost to end-of-life treatment could be substantial. When faced with battery replacement costs⁹⁷ that approach the cost of a new car, some car owners can be expected to dump their EVs to the second-hand car market and these could end up as abandoned vehicles⁹⁸. To this end, there is considerable concern at the county level (see Appendix, Communications C17).

⁹² As required under the terms of power purchase agreements between the State and the power producer.

⁹³ Following the terms of their PPA agreement with the State.

⁹⁴ For example, by placing a lien on the land.

⁹⁵ Competition between companies, advantages to scale, changing laws and other unknowns.

⁹⁶ Based on an average vehicle weight of 3,500 pounds, a recycle cost of \$4.50 per pound.

⁹⁷ Costs to replace a battery will include the price of a new battery, the cost to recycle the old batter, and labor.

⁹⁸ It is assumed that second or third hand owners will have difficulty affording the cost of recycle.

Expanded producer responsibility. Under this scenario, the manufacture, most likely through the dealerships, would be required to manage end-of-life treatment of their electric vehicle or energy system storage LIBs. Regarding energy storage systems, as late as July 2020 no U.S. federal policy directly addressed battery energy storage system decommissioning, or mandated or incentivized reuse/recovery of lithium-ion batteries [173, 174]. While there are no state or local laws specifically addressing LIB recycling, except for universal waste regulations, a variety of states have regulations governing the recycling of lead-acid and other batteries that could ultimately be applied to LIBs [174]. For example, California has lead-acid battery recycling regulations and EPR (extended producer responsibility) regulations for rechargeable battery recycling. Both California and New York require retailers to accept battery returns from customers and to recycle them [174].

Although Hawai'i similarly requires retailers and wholesalers of lead-acid batteries to accept old batteries when new batteries are purchased (Chapter 342I, Hawai'i Revised Statutes), it should be noted that the lead acid batteries are far simpler to recycle, far more stable from a safety point of view, and possess a design that highly standardized across manufacturers. As such, the existing model for recycling lead acid batteries will not readily transfer to the processing of LIBs. This degree of product equivalence has permitted the growth of an established and reliable recycling industry⁹⁹, a reality that facilitates the outsourcing of responsibility for the collection, transport, and payment of lead acid batteries (to mainland recycles) from the State to a variety of local businesses, some of whom pay a small amount to the generator of the battery¹⁰⁰.

This situation, by contrast, is not yet equivalent for LIBs which do not possess similar product equivalency across make and model¹⁰¹. As such, complex and energy-intensive LIB recycling processes are still being tailored to a specific make or model. Unfortunately, manufactures have yet to established stable recycling options for their own batteries. Regarding EV LIBs, for example, only one automaker (Tesla) has announced an intention to take back and recycle their batteries while others¹⁰² propose to pursue refurbishing for reuse in energy storage system batteries [175]. Although promising, Tesla's recycling plant is under development, only recycling a fraction of its batteries [150]. Current options for disposal of EV or energy storage system LIBs are expensive (see Appendix, Communications C18) environmentally questionable, and subject to unpredictable local and regional policies. China, for example, has already stopped the importation of electronic waste and the possibility that such policies will be extended to PV modules and EV

⁹⁹ See, for example, recycling lead-acid batteries is easy. Why is recycling lithium-ion batteries hard? By James Morton Turner. <https://cleantechnica.com/2022/07/24/recycling-lead-acid-batteries-is-easy-why-is-recycling-lithium-ion-batteries-hard/>.

¹⁰⁰ See, for example, the following representative link: <https://footprinthero.com/how-to-recycle-lead-acid-batteries>.

¹⁰¹ Materials used within a given brand of LIB, particularly with the chemistries of the cathode and electrolyte, as well as the structure and material used in the casing not only vary between manufacturers, but can vary between models of the same battery.

¹⁰² Hyunda, Renault, BMW.

and energy storage system batteries must be considered¹⁰³. Moreover, the refurbishing market has yet to be established for all makes and brands, with only a few on the mainland operating successfully¹⁰⁴. Finally, the chance of some manufacturers abandoning their product lines or going bankrupt remains a distinct possibility.

For these reasons, expectations to enforce Extended Producer Responsibility laws in Hawai'i should be approached cautiously, at least for the foreseeable future. Manufacturers, despite the promise of technological developments, only have programs at pilot scale¹⁰⁵. The few mainland recyclers that advertise themselves to take LIBs regardless of make or model are similarly small and under development. Similar to the PV module recycling industry, Hawai'i's market share of electric vehicles is quite small compared to the U.S. or global market and attempts to legally impose EPR laws that extend beyond the reach of U.S. law, could result in manufactures of electric vehicles and energy storage systems disengaging from Hawai'i. As such, any realistic dependency on EPR pathways in Hawai'i will follow similar efforts in California or the U.S.

State assisted recycle. Under this scenario, salvagers or mechanics who arrange for the collection and transport of LIBs from abandoned vehicles to mainland recycle sites would receive some reimbursement¹⁰⁶. Similar to PV modules, the question of how the State would raise the revenue is complicated by issues of equity and practicality. Although mechanisms to reimburse the cost of recycling orphaned power tool size lithium batteries exist in Hawai'i, these programs are not presently prepared to underwrite the cost of recycling EV or energy storage scale LIBs (see Appendix, Communications C19). Unlike the PV module industry, however, the collection and disbursement of reimbursement funds could be simpler to organize and enforce. The most functional point to collect fees would be at the point of purchase or car registration fees (see Appendix, Communications C20).

Fees assigned at the time of purchase would have the auto dealerships to assess the surcharge and then transfer these funds to the State Assisted Recycle program. However, as mentioned above, the cost to recycle a Tesla would add approximately \$15,520 to the purchase price. In the case of energy storage systems, this would require that the contractor installing the battery system would charge, collect, and transfer the fee to the State. If EPR programs advanced the actual amount of the advanced disposal fee, this cost could be reduced or even removed.

¹⁰³ See <https://www.reuters.com/article/us-china-waste-imports/china-plans-to-cut-waste-imports-to-zero-by-next-year-official-idUSKCN1R90AQ>.

¹⁰⁴ See Bubblebee Battery Recycling which refurbishes Toyota and Honda LIB. <https://bumblebeebatteries.com/>.

¹⁰⁵ See, for example, <https://electrek.co/2022/03/21/heres-what-the-future-of-battery-recycling-is-going-to-look-like-for-ev-owners/>.

¹⁰⁶ This could occur, for example, through the counties via their current interactions with salvagers and other processors of abandoned or discarded waste.

Solar Hot Water Systems

Solar water systems are processed by recyclers who first recover recyclable metals before disposal. Depending on the size, solar water systems would be managed as a white good as it enters the recycling facility, or as scrap metal. Removing the metal components could be part of the white good recycling process. The current market price of recyclable metals covers the cost of disposal. Additional fees are not perceived as necessary.

Summary and Recommendations

The new and emerging waste streams of PV modules and lithium-ion batteries will begin to accelerate to significant levels in Hawai'i during the latter half of this decade. During this analysis, however, it has become apparent that most stakeholders (e.g., relevant State government agencies, counties refuse divisions, local salvagers and recyclers) in Hawai'i who will have a role in the management, collection, disposal, and recycling of these new and emerging waste streams are neither prepared nor have the capacity to process those levels. Moreover, the generators of these waste streams are largely unaware of or prepared to bear the full costs of their disposal. For example, it has been learned that both local and mainland recyclers are already being contacted by local contractors for disposal quotes that are not followed up on because of the high costs. The concern is that unless these hurdles are addressed, the risk of continued and increased unlawful dumping of these materials in Hawai'i is high (and is likely already occurring).

There is time, however, for all stakeholders in Hawai'i to prepare as the surge in these new and emerging waste streams are not expected to accelerate until later this decade. There is also good reason to assume that each of proposed solutions will provide a real benefit that, when pursued together, will prove quite effective. For example, mainland efforts are addressing effective EPR laws¹⁰⁷ as well as established and reliable recycling options¹⁰⁸. Moreover, as reuse and recycling pathways mature on the mainland, the cost of recycle will decrease, further enhancing the utility and variety of accessible pathways¹⁰⁹. That being said, the costs associated with on-island pre-processing¹¹⁰ and off-island shipping will not decrease, and as such the recycling of either waste stream will not be a net profit activity, at least for the foreseeable future.

For these reasons, to achieve comprehensive and effective disposal and recycling of these waste streams, it is recommended to pursue some combination of all three proposed options.

¹⁰⁷ See, for example, the following webinar addressing solar panel recycling and EPR at <https://oregonrecyclers.org/events/webinar-solar-panel-recycling-epr>.

¹⁰⁸ See, for example, the following We Recycle Solar website at <https://werecolesolar.com/>.

¹⁰⁹ See, for example, a company that rebuilds Honda and Toyota hybrid EV batteries at <https://bumblebeebatteries.com/>.

¹¹⁰ For example, removing frames from PV panels or de-activating EV or energy storage system LIBs.

Specifically, to take steps to:

1. Ensure and enforce waste generator responsibility;
2. Pursue and manage EPRs where possible; and
3. Implement an Advanced Disposal Fee program.

Step 1 is based on recommendations from the Hawai'i Department of Health, which is charged with enforcement of rules and regulations targeting waste streams in Hawai'i. It is fair and equitable to expect panel and battery owners, who benefit directly from the use of their clean energy materials, to take responsibility for their disposal. That being said, it is also fair to suggest that some users may not have been appropriately informed of the costs and unique responsibilities¹¹¹ associated with their disposal of these materials. Step 2 is based upon recommendations from proponents of extended producer responsibility (EPR). Utility-scale projects will eventually be responsible for the disposal of large-scale amounts of waste at high cost and in those cases where the PPAs were not written with "airtight" end-of-life responsibilities and/or the IPPs are near or insolvent, the presence of EPRs would be extremely beneficial. In addition, there are equity considerations when evaluating who should be responsible for the management of waste streams generated by private companies, households, and businesses. Step 3 is based on recommendations from the counties that are ultimately faced with the burden of financing the disposal of abandoned PV modules and LIBs. Currently, county staff manage the small amounts of LIBs (see Appendix, Communications C21) entering the waste stream by dipping into revenues from vehicle registration fees. Concerns have been raised, however, with how to pay for these costs as the number of batteries increases with time (see Appendix, Communications C22). Advanced disposal fees, for example, could also be used to sponsor amnesty programs that serve to bring in wastes that would otherwise be dumped¹¹².

In addition, it is also recommended to:

1. Continue the work of tracking the penetration and composition of clean energy materials and updating, as appropriate, the predicted disposal loading rates;
2. Develop and environmental waste management strategy for these clean energy waste streams;
3. Organize the education and training of contractors, salvagers, and relevant staff in the counties as to best practices and laws governing the collection, storage, and transport of these clean energy waste streams;
4. Organize public service announcements educating residential, commercial, and utility-scale owners of their waste generator responsibilities;
5. Review PPAs with respect to end-of-life disposal responsibilities as well as mechanisms for enforcement in cases of IPP default;

¹¹¹ Specifically, that the materials they purchased and had installed are classified as hazardous waste.

¹¹² See the following link that describes an amnesty program for mattress and box springs.

<https://yubanet.com/regional/wm-offers-free-mattress-and-box-spring-drop-off-at-mccourtney-road-transfer-station/>.

6. Assist recyclers, as appropriate, with the expansion of their businesses to increase their capacities, including those based in Hawai'i and potential business partners in the U.S.;
7. Identify and track EPR opportunities;
8. Identify and track mainland recyclers,
9. Identify funding for the disposal and recycling of clean energy materials; and
10. Consider state-wide agreements with off-island recyclers that support long-term and cost-effective access.

These activities, pursued together over five to seven years, have the potential to provide a comprehensive and effective environmental management system (EMS) to manage an effective stakeholder-wide response to these new and emerging waste streams. Moreover, as the learning curve grows and all stakeholders become better acclimated to their management of these waste streams, some of these activities can be modified or even phased out.

OTHER ISSUES TO CONSIDER FOR MANAGEMENT, RECYCLING, AND DISPOSAL

This section identifies additional issues related to the management, recycling, and disposal of clean energy systems that may be pertinent to the Act 92 request. To that end, the working group of HNEI, the Hawai'i Department of Health, the Hawai'i State Energy Office, as well as other stakeholders¹¹³ have developed the following additional list of issues for consideration.

Power Purchase Agreements

Utility-scale installations should include, in the power purchase agreements (PPAs), provisions that place responsibility on the independent power producers (IPP) to cover the end-of-life disposal and/or treatment of clean energy materials. This will remove a significant burden on local waste disposal handlers as well as impacted State agencies and counties. Throughout the development of this report, several suggestions emerged to ensure effective PPAs. The first is for the State to insert into the PPA a provision that requires IPPs to remove and transport *all* of the clean energy materials off the island at the end of the agreement. The advantage to this requirement is that the State bears no responsibility for processing the end-of-life treatment of utility-scale clean energy waste. The disadvantage to this option is that State has no certain protection against bankruptcy of a given IPP. To guard against this potentiality, the second option is to attach a fee or deposit requirement as part of the PPA that requires funds to be put away for the disposal of these materials at their end-of-life¹¹⁴. The advantage to this option is that State can collect the necessary funds at the start of the project and therefore does not bear the risk of a given IPP declaring bankruptcy and leaving behind clean energy materials. The disadvantages to this option are that the costs of end-of-life treatment are difficult to estimate accurately, the end of life can occur as many as twenty years later and the State will have to manage both the funds and the logistics of off-island transportation of all clean energy materials.

Extended Producer Responsibility

Extended producer responsibility (EPR) or similar models, whereby the manufacturer, reseller, or installer is responsible for the end-of-life management of PV modules, electronic items, and batteries, is conceptually attractive. It also has a successful model in the management of lead-acid batteries. In addition to lifting the product's end-of-life burden off the State, the EPR model has the added effect of encouraging manufacturers of clean energy materials to design the fabrication of their products to better support the end of life recycling or reuse. The challenges to the EPR model, with respect to PV modules and energy storage batteries, is the difficulty in identifying and gaining compliance from the responsible manufacturer. In addition to a general ongoing resistance

¹¹³ e.g., contractors, recyclers, county refuse and recycle coordinator staff, mainland recyclers...etc.

¹¹⁴ This is similar to the decommissioning fee that all nuclear reactors pay.

of these manufactures to take on these burdens, the production of PV modules and energy systems batteries occurs through multiple layers of manufacturers of which many are outside the U.S.¹¹⁵. As a consequence, it can be difficult to identify which manufacturer is responsible. Moreover, if that producer is outside the U.S., it can be difficult if not impossible to enforce compliance (on them). Finally, as both recycle and reuse industries are fluid and developing, the risk of a given manufacturer of PV modules or LIBs going out of business before their products reach end of life is real and significant¹¹⁶.

Landfill Ban

While universal waste and hazardous waste regulations generally prohibit the dumping of universal waste PV modules, electronic items and LIBs into local municipal solid waste landfills (the State of Hawai‘i does not have any hazardous waste landfills), there is currently an exclusion for household hazardous waste. Unless the Department of Health’s Hazardous Waste Program makes a clear determination that solar PV modules removed from residential structures do not meet the conditions of this exclusion (see “*PV modules – disposal*” in Section 4), this allows residential PV modules to be landfilled. Moreover, PV modules are currently landfilled in many states in the U.S. at relatively low cost. However, concerns about landfilling PV modules are increasing. As such, full landfill bans may become a reality. In this case, recycling, with its higher costs, will become the only remaining option and the challenges of high transport costs to recycle previously discussed will become paramount. In this case, the State may need to charge sufficient fees (e.g., Advanced Disposal Fee) to supplement the cost of disposal at residential and commercial scale and, at utility-scale, require the placement of deposits in the absence of enforceable PPAs.

Handling Issues Associated with Lithium-ion Batteries

Lithium-ion batteries, as currently designed, present a real threat of fires and extreme challenges to firefighters. It may take several generations of battery modifications by manufacturers to lessen the hazard of fires at recycling plants. In a recent publication, for example, the existential threat of lithium-ion battery fires to the recycling industry in California was emphasized.

“Every (Materials Recycling Facility) MRF, pretty much, in California is experiencing fires, if not on a daily basis, on a weekly basis.... We're on the fringe of losing our recycling infrastructure that we've built over several decades to try and recycle this stuff” [176].

¹¹⁵ In the case of PV modules, the solar cells may be produced by one manufacturer while the PV module itself may be assembled by a second. In the case of batteries, the battery cell is manufactured by one producer and assembled into a battery pack or module by another.

¹¹⁶ See for example the following press release announcing LG is leaving the PV module production business. <https://www.lg.com/us/press-release/lg-to-exit-global-solar-panel-business>.

This growing hazard serves to emphasize the risk to storage and transport of LIBs at local and regional recycling centers. It also raises concerns around their ocean transport from Hawai'i. In the case of an extreme weather event that causes damage to large numbers of residential, commercial, or utility-scale LIBs, this increases the chance of LIBs being damaged to the point of increased threat of flammability and explosion. Given these risks, procedures should be put in place to manage the collection, storage, and transport of a large number of damaged EV or energy storage LIBs.

Household Hazardous Waste Exclusion

Currently, the household waste exclusion permits the landfilling of hazardous waste generated by households. The Hawai'i Department of Health's Hazardous Waste Program has not yet taken a position on whether solar PV modules removed from residential structures meet the conditions of this exclusion. If solar PV modules from household residences are excluded from the household waste exclusion, residential waste generators¹¹⁷ will be exposed to unexpectedly high end-of-life treatment costs. These types of unexpected cost "shocks" often lead to and promote the kind of illegal dumping that is very difficult to monitor and regulate.

¹¹⁷ Or the contractor they seek for quotes.

APPENDIX – TABLES

Table A1. Chemical composition of c-Si PV modules.

Power	Weight	Panel	Glass	Al	Encapsulant EVA	Si	Backsheet PVF/PET	Kg/kWdc										
								Cu	Mg	Pb	Sn	Ag	Ni	Zn				
Wdc	kg																	
215	22.3	1.04E+02	6.43E+01	2.28E+01	7.78E+00	4.15E+00	2.59E+00	3.84E-01	-	1.23E-01	1.24E-01	1.43E-01	-	-	-	-	-	-
165	-	-	6.91E+01	2.30E+01	7.88E+00	1.77E+00	3.20E-01	8.50E-01	-	2.40E-02	4.20E-02	-	1.20E-03	-	-	-	-	-
215	21.99	1.02E+02	7.59E+01	1.05E+01	6.65E+00	3.56E+00	3.68E+00	5.83E-01	-	7.16E-02	1.23E-01	5.11E-02	-	-	-	-	-	-
220	22	1.00E+02	7.00E+01	1.80E+01	5.10E+00	3.56E+00	1.53E-01	9.33E-01	-	2.60E-02	2.60E-02	5.30E-02	-	-	-	-	-	-
220	22	1.00E+02	6.80E+01	2.10E+01	5.00E+00	-	1.00E-01	4.01E-01	-	3.00E-02	3.00E-02	1.50E-01	-	-	-	-	-	-
250	19	7.60E+01	-	-	-	2.29E+00	-	5.06E-01	-	1.60E-01	-	2.88E-02	-	-	-	-	-	-
225	24	1.07E+02	6.98E+01	1.76E+01	8.43E-02	4.27E+00	-	7.80E-01	5.55E-01	4.98E-02	6.25E-05	6.15E-02	1.06E-05	1.06E-05	8.32E-06	-	-	-
270	18.6	6.89E+01	5.24E+01	5.51E+00	4.82E+00	3.44E+00	3.20E-01	6.89E-01	-	-	-	6.89E-02	-	-	-	-	-	-
224	23	1.03E+02	-	1.65E+01	-	7.95E-01	-	7.37E-01	5.22E-01	4.91E-03	-	1.32E+00	-	-	-	-	-	-
210	-	-	7.67E+01	2.00E+01	7.62E+00	-	3.95E+00	8.57E-01	-	2.38E-02	4.29E-02	-	1.24E-03	-	-	-	-	-
220	21.2	9.64E+01	4.37E+01	1.13E+01	4.40E+00	-	2.09E+00	4.77E-01	-	1.33E-02	2.41E-02	-	-	-	-	-	-	-
224	16	7.14E+01	5.00E+01	1.29E+01	3.64E+00	2.61E+00	1.07E+00	3.14E-01	-	1.79E-02	1.79E-02	3.57E-02	-	-	-	-	-	-
224	23	1.03E+02	6.58E+01	1.66E+01	6.52E+00	7.95E-01	-	7.36E-01	5.22E-01	4.70E-03	6.00E-05	5.80E-02	1.07E-03	1.07E-03	1.00E-05	-	-	-
AVE	21.51	9.37E+01	6.41E+01	1.63E+01	5.41E+00	2.72E+00	1.59E+00	6.34E-01	5.33E-01	4.57E-02	4.30E-02	1.97E-01	8.80E-04	8.80E-04	9.16E-06	-	-	-
AVEDEV	1.55	1.18E+01	8.43E+00	4.18E+00	1.71E+00	1.07E+00	1.33E+00	1.75E-01	1.44E-02	3.68E-02	3.22E-02	2.25E-01	4.35E-04	4.35E-04	8.40E-07	-	-	-

Table A2. Material composition of 500 kW_{ac} PV inverters. Values estimated per kW rating of inverter.

Power	Weight	Cu	Steel	Al	Ag	Ni	Au	Sn	Pb	Fe	Zn	Mg	Mn	Ta
kWac	kg													
500.0	3.824	6.78E-01	2.88E+00	2.62E-01	7.40E-04	3.20E-04	1.02E-03	4.00E-05	3.60E-03	1.00E-04	1.00E-03	2.00E-05	2.00E-06	4.00E-05
500.0	-	1.95E+00	-	7.53E-01	2.13E-03	9.20E-04	2.90E-03	6.00E-05	1.04E-02	2.90E-04	2.30E-03	6.00E-06	1.00E-05	1.20E-04
AVE	3.82E+00	1.31E+00	2.88E+00	5.08E-01	1.44E-03	6.20E-04	1.96E-03	5.00E-05	7.00E-03	1.95E-04	1.65E-03	1.30E-05	6.00E-06	8.00E-05
AVEDEV	0.00E+00	6.36E-01	0.00E+00	2.46E-01	6.95E-04	3.00E-04	9.40E-04	1.00E-05	3.40E-03	9.50E-05	6.50E-04	7.00E-06	4.00E-06	4.00E-05

Table A3. Material composition of low power solar inverters.

Power	Weight	Cu	Steel	Al
kWac	kg	kg/kWac		
old low power inverter				
0.5	1.6	1.25E-03	4.88E-02	4.26E-01
2.5	18.5	2.98E-01	5.30E-01	5.60E-01
new low power inverter				
2.5	11.2	0.76	0.36	2.00
5.0	18.0	0.62	0.30	1.60
10.0	28.9	0.49	0.23	1.28
20.0	46.2	0.40	0.19	1.03

Table A4. Power density of inverters across scale for residential and commercial microinverters.

Manufacture	Model	Max output power	Weight	Density
		kWac	kg	kg/kWac
Enphase	M190-72-240-S13	0.19	1.99	10.474
Siemens	SMINT215R60xx	0.215	1.600	7.442
Siemens	M215-60-2LL-S22-IG	0.215	1.460	6.791
Enphase	Enphase, M215-IG	0.215	1.540	7.163
Enphase	IQ8-60-2-US	0.240	1.080	4.500
Vikye	Vikye581hcb4y	0.250	1.050	4.200
Heayzoki	Heayzokisavzqehxkg6351-11	0.250	0.995	3.980
Enphase	IQ8PLUS-72-2-US	0.290	1.080	3.724
Enphase	IQ7A-72-2-US	0.290	1.080	3.724
Walfront	Walfrontpgmv7213kw-12	0.330	0.997	3.021
Enphase	IQ7A-72-2-US	0.349	1.080	3.095
Apsystems	YC600	0.548	2.600	4.745
Kaideng Energy	WVC-600	0.580	2.800	4.828
Mophorn	600W MPPT	0.600	2.270	3.783
Vevor	WVC600-433WiFi	0.600	2.800	4.667
Vesdas	WVC-700	0.700	2.500	3.571
Mophorn	1200W MPPT	1.200	3.630	3.025
Sunket-ESS	SUNG2-US-230	1.300	2.400	1.846

Table A5. Power density of inverters across scale for residential and commercial central/string inverters.

Manufacture	Model	Max output power	Weight	Density
		kWac	kg	kg/kWac
Solar Edge	SE3000A-US	3.000	20.200	6.733
Solar Edge	SE5000A-US	5.000	21.700	4.340
Solar Edge	SE7000A-US	7.000	21.700	3.100
Solar Edge	SE10000A-US	10.000	37.100	3.710
Solar Edge	SE11400A-US	11.400	37.100	3.254
Solar Edge	SE3K	3.000	16.400	5.467
Solar Edge	SE4K	4.000	16.400	4.100
Solar Edge	SE5K	5.000	16.400	3.280
Solar Edge	SE7K	7.000	16.400	2.343
Solar Edge	SE7600A-US	7.6	24.7	3.250
Solar Edge	SE9K-US	9	30.2	3.356
Solar Edge	SE10000A-US	10	40.1	4.010
Solar Edge	SE10K-US	10	30.2	3.020
Solar Edge	SE14.4KUS	14.4	32.5	2.257
Solar Edge	SE17.3KUS	17.3	32.5	1.879
Solar Edge	SE20KUS ¹	20	33.7	1.685
Solectra	PVI 25TL-208	25	56	2.240
Solar Edge	SE30KUS	30	35.5	1.183
Solar Edge	SE40KUS ¹	40	35.5	0.888
Solectra	XGI 1000-60	60	55.8	0.930
Solectra	XGI 1000-60	65	55.8	0.858
KACO	blue planet 125 TL3 M1 WM OD IIPO	125	78.2	0.626
Solectria	XGI 1500-125	125	122	0.976
KACO	blue planet 150 TL3 M1 WM OD IIQO	150	78.2	0.521
Solectria	XGI 1500-150/166	150	122	0.813
Solectria	XGI 1500 175-480	175	131.5	0.751
Solectria	XGI 1500 200/200-480	200	131.5	0.658
Solectria	XGI 1500-250	250	131.5	0.526

Table A6. Power density of inverters across scale for large utility inverters.

Manufacture	Model	Max output power	Weight	Density
		kWac	kg	kg/kWac
ABB	PVS800-57-0100KW-A	100	550	5.500
ABB	PVS800-57-0250KW-A	250	1100	4.400
ABB	PVS800-57-0500KW-A	500	1800	3.600
ABB	CORE -500.0-TL	500	1100	2.200
ABB	CORE -1000.0-TL	1000	2005	2.005
Firmer	R18615TL	1555	1600	1.029
SMA	SC 2750 UP-US	2750	4000	1.455
SMA	SC 4000 UP-US	4000	3700	0.925

Table A7. Weight percentage of components across Li-ion battery chemistries [50, 67, 176, 177].

Manufacturer	Source	Positive electrode		Positive electrode base		Negative electrode		Negative electrode base		Electrolyte		Outer Case	
		(wt%)	(chemistry)	(wt%)	(chemistry)	(wt%)	(chemistry)	(wt%)	(chemistry)	(wt%)	(chemistry)	(wt%)	(chemistry)
Lithium Ion													
Sanyo	Safety Data Sheet	20-60	LMO	1-10	Aluminum	10-30	90% Carbon, 10% silicon	1-15	Copper	5-25	Ester carbonate and 1 M.LiPF6	1-30	Aluminum, iron, Aluminum laminated plastic
Tesla	Safety Data Sheet	33	NCA, NMC, NMO, LCO	5	Aluminum	21	Carbon	7	Copper	10	Alkyl carbonate and 1 M.LiPF6	20	Iron and other
Generic	Yu et al 2021	31	LMO, LCO, NMC, NCA, LFP	8	Aluminum	22	Graphite	17	Copper	15	Alkyl carbonate and 1 M.LiPF6 or LBF4	NR	NR
Generic	Li et al (2018)	27.5	LCO	7.25	Aluminum	16	Nongraphitized carbon	7.25	Copper	3.5	Alkyl (propylene and diethyl) carbonate and 1 M.LiPF6	24.5	Steel, Nickel
LG Chem	Safety Data Sheet	20-50	Metal Oxide: proprietary	2-10	Aluminum	10-30	Carbon	2-10	Copper	10-20	Proprietary - not reported	Remainder	Stainless Steel, Nickel and inert materials
LG Chem	Safety Data Sheet	4-50	NMC	2-10	Aluminum	10-30	Carbon	2-10	Copper	10-20	Proprietary - not reported	Remainder	Stainless Steel, Nickel and inert materials
LGCHEM	Safety Data Sheet	20-50	Metal Oxide: proprietary	2-10	Aluminum	10-20	Carbon	2-10	Copper	10-20	Proprietary - not reported	Remainder	Aluminum, Copper, and inert materials
Acumentrics	Safety Data Sheet	25-35	LFP	3-7	Aluminum	12-18	Carbon	5-9	Copper	10-18	Alkyl (ethylene, dimethyl, ethyl methyl) carbonate and 1 M.LiPF6	18-22	Mild steel
Generic	Zhu et al 2021	25.5	NMC, LCO, LMO, LFP	6.9	Aluminum	14.5	Carbon	8.1	Copper	11.2	Alkyl (propylene, ethylene, ethyl methyl, dimethyl, diethyl) carbonate and lithium salts	30	Not specified
Generic	Diekman et al (2017)	14.80	NMC	5.5	Aluminum	8.2	Carbon	9.2	Copper	8.3	Volatile Components	29.4	Steel, Aluminum, Plastics
Generic forecasted	Kocllhar and Johnston (2018)	33.00	NMC, LFP, LMO	8.0	Aluminum	15	Graphite	9.9	Copper	13.5	Alkyl (ethylene, ethyl methyl) carbonate and 1 M.LiPF6	18.4	Steel, Plastics, Aluminum
Altrairnano	Safety Data Sheet	20-40	NMC	1.5-6	Aluminum	15-35	Lithium titanium oxide	1.5-6	Aluminum	10-20	Alkyl (ethyl and ethylen, dimethyl) carbonate and 1M LiPF6. LIBOB is also an additive.	NR	NR
Nickel Metal Hydride													
EFK	Safety Data Sheet	15-25	NiHM	5-15	Nickel	20-40	Hydrogen Absorbing Alloy (Ni, Co, Mn, Al)	20-40	Iron	0-15	Alkaline electrolyte principally comprised of potassium, sodium, or lithium hydroxide	NR	NR
Generic	Torabi et al (2019)	15-25	NiHM	15-25	Nickel	20-40	Hydrogen Absorbing Alloy (Ni, Co, Mn, Al)	20-40	Iron	0-15	Alkaline electrolyte mostly comprised of potassium, sodium, or lithium hydroxide	NR	NR
Motorola	Product Data Sheet	10-35	NiHM	10-25	Nickel	15-30	Hydrogen Absorbing Alloy (Ni, Co, Mn, Al)	10-30	Nickel	15-Oct	Alkaline electrolyte mostly comprised of potassium, sodium, or lithium hydroxide	25-Oct	Steel

Table A8. Battery energy density as a function of chemistry and scale. Sources: Literature [21, 176, 178, 179] and product specification sheets.

Chemistry	Scale	Energy Density
		kWh/kg
LFP/C	Cells/Modules	0.101/0.101
LFP/C	Cells/Modules	0.121/0.121
LFP/C	Cells/Modules	0.121/0.124
LFP/C	Cells	0.12
LFP/C	Cells	0.131
LFP/C	Power System	0.09
NCA/C	Cells	0.236
NCA/Si-C, SiO-C	Cells	0.236
NCA/Si-C	Cells	0.36
NMC/C	Cells/Modules	0.112/0.112
NMC/C	Cells	0.13
NMC/LTO	Cells	0.089
NMC/C	Cells	0.152
NMC/C	Cells	0.186
NMC/C	Cells	0.241
NMC-LMO/C	Cells	0.109
NMC-LMO/C	Cells	0.172
NMC-LMO/C	Cells	0.157
LMO-NCA/C	Cells	0.155
LMO-NCA/C	Cells	0.167
LFP/C	Power System	0.09
NMC/C	Power System	0.12
NMC/C	Power System	0.13
NMC/C	Power System	0.16
NMC/C	Power System	0.14
NMC/C	Power System	0.12
NMC/C	Power System	0.11

Table A9. Cumulative installed PV across island and scale through 2021.

Location	Unit	2005	2006	2007	2008	2009	2010	2011	2012	2013	2014	2015	2016	2017	2018	2019	2020	2021
Residential - HECO	MWac	0.7	1.0	1.9	4.9	9.8	16.4	32.4	70.2	143.7	184.0	216.1	250.7	271.1	287.8	303.3	334.0	358.6
Residential - HELCO	MWac	0.1	0.2	0.4	1.0	1.9	3.2	6.3	13.4	22.5	33.1	45.4	53.8	58.5	63.1	68.0	72.6	76.6
Residential - MECO	MWac	0.2	0.2	0.4	1.1	2.2	3.6	7.1	15.9	24.1	34.3	47.0	60.0	63.9	66.1	71.3	77.9	82.6
Residential - KIUC	MWac	0.0	0.0	0.0	0.0	0.0	0.0	1.9	3.1	5.8	8.3	11.7	13.3	14.8	16.3	17.2	18.6	18.6
Commercial - HECO	MWac	0.5	0.7	1.3	3.4	6.7	11.2	22.1	48.8	77.4	99.1	126.9	160.3	202.6	216.9	232.8	254.1	266.49
Commercial - HELCO	MWac	0.1	0.1	0.3	0.7	1.4	2.4	4.7	10.9	15.7	18.6	24.4	27.7	31.5	34.0	35.0	37.4	39.44
Commercial - MECO	MWac	0.1	0.2	0.3	0.8	1.7	2.8	5.5	12.5	16.8	20.2	26.5	33.7	39.1	49.9	53.8	54.1	57.4
Commercial - KIUC	MWac	0.0	0.0	0.0	0.0	0.0	0.0	4.0	2.0	2.9	4.9	6.4	11.8	13.6	14.1	14.4	15.0	15.0
Utility - HECO	MWac	0.0	0.0	0.0	0.0	0.0	0.0	0.0	7.0	7.0	12.0	23.0	29.5	62.5	62.5	192.1	197.7	197.7
Utility - HELCO	MWac	0.0	0.0	0.0	0.0	0.0	0.0	0.0	0.0	0.0	0.0	0.0	0.0	0.0	0.0	0.0	0.0	0.0
Utility - MECO	MWac	0.0	0.0	0.0	1.2	1.2	1.2	1.2	1.2	1.2	1.2	1.2	1.2	1.2	1.2	7.0	7.0	7.0
Utility - KIUC	MWac	0.0	0.0	0.0	0.0	0.0	1.0	1.0	7.0	7.0	19.0	31.0	31.0	46.0	66.0	80.0	80.0	80.0
SUM - Residential	MWac	1.0	1.4	2.7	7.0	13.9	23.2	47.8	102.6	196.1	259.7	320.2	377.7	408.3	433.3	459.8	503.1	536.4
SUM - Commercial	MWac	0.7	1.0	1.9	4.9	9.8	16.4	36.4	74.2	112.7	142.7	184.2	233.5	286.9	314.8	336.0	360.7	378.3
SUM - Utility	MWac	0.0	0.0	0.0	1.2	1.2	2.2	2.2	15.2	15.2	32.2	55.2	61.7	109.7	135.5	279.1	284.7	284.7
Culmative PV	MWac	1.8	2.4	4.7	13.1	25.0	41.8	86.4	192.0	324.0	434.6	559.6	673.0	804.8	883.5	1074.8	1148.4	1199.4

Table A10. Cumulative number of installed Enphase microinverters through 2022 as a function of island. Data (not shown) from Molokai is 62 in 2019 and 3 in 2020. Source: Enphase.

Hawai'i		Kauai	
Year	Microinverters commissioned	Year	Microinverters commissioned
2008	40	2009	144
2009	594	2010	1451
2010	3476	2011	3021
2011	13293	2012	6890
2012	37025	2013	9112
2013	32500	2014	7646
2014	32357	2015	8091
2015	32490	2016	4389
2016	15522	2017	4016
2017	8034	2018	4094
2018	9492	2019	5199
2019	11551	2020	5422
2020	10962	2021	6884
2021	9867	2022	998
2022	2313		
Total	219516	Total	67357
Maui		O'ahu	
Year	Microinverters commissioned	Year	Microinverters commissioned
2008	77	2008	656
2009	1996	2009	4003
2010	4273	2010	19046
2011	20951	2011	68433
2012	40006	2012	245215
2013	31778	2013	190996
2014	36561	2014	103581
2015	46757	2015	100048
2016	31158	2016	77528
2017	9921	2017	46383
2018	10473	2018	34741
2019	7559	2019	51260
2020	9375	2020	61050
2021	10874	2021	52010
2022	3133	2022	11389
Total	264892	Total	1066339

Table A11. Cumulative installed storage across island and scale through 2021.

	2005	2006	2007	2008	2009	2010	2011	2012	2013	2014	2015	2016	2017	2018	2019	2020	2021
Residential & Commercial- HECO	MWh	0.0	0.0	0.0	0.00	0.00	0.00	0.7	1.0	1.1	1.5	2.2	5.4	30.3	57.0	134.8	207.3
Residential & Commercial- HELCO	MWh	0.0	0.0	0.0	0.0	0.0	0.0	0.2	0.2	0.2	0.2	0.4	4.0	17.7	42.1	65.1	91.7
Residential & Commercial- MECO	MWh	0.0	0.0	0.0	0.0	0.0	0.0	0.1	0.1	0.1	0.1	0.1	1.6	5.5	17.1	38.8	52.3
Residential & Commercial - KUJC	MWh	0.0	0.0	0.0	0.0	0.0	0.0	0.0	0.0	0.0	0.0	0.0	2.1	3.9	8.2	7.8	20.5
Utility - HECO	MWh	0.0	0.0	0.0	0.0	0.0	0.0	0.0	0.0	0.0	0.0	0.3	0.3	0.3	0.3	0.3	0.3
Utility - HELCO	MWh	0.0	0.0	0.0	0.0	0.0	0.0	0.0	0.0	0.0	0.0	0.0	0.0	0.0	0.0	0.0	0
Utility - MECO	MWh	0.0	0.0	0.0	0.0	24.4	24.4	24.4	24.4	24.4	24.4	24.4	26.4	26.4	26.4	26.4	26.4
Utility - KIUC	MWh	0.0	0.0	0.0	0.0	0.0	0.0	0.0	0.0	0.0	4.6	4.6	56.6	156.6	156.6	156.6	156.6
SUM - Residential & Commercial	MWh	0.0	0.0	0.0	0.0	0.0	0.0	1.0	1.3	1.4	1.8	2.7	13.0	57.5	124.4	246.5	371.8
SUM - Utility	MWh	0.0	0.0	0.0	0.0	24.4	24.4	24.4	24.4	24.4	29.0	29.3	83.3	183.3	183.3	183.3	183.3
Cumulative storage	MWh	0.0	0.0	0.0	0.0	24.4	24.4	25.4	25.7	25.8	30.8	32.0	96.3	240.8	307.7	429.8	555.1

Note: The data above was calculated from data from HECO in kW of new battery capacity of installed per year. To convert from MW to MWh a factor of 2.7 was used.

	2005	2006	2007	2008	2009	2010	2011	2012	2013	2014	2015	2016	2017	2018	2019	2020	2021
Residential & Commercial- HECO	kW	NR	NR	NR	NR	NR	NR	270	115.6	41.8	130	266.1	1169	9248.1	9874.1	28813.7	26867.5
Residential & Commercial- HELCO	kW	NR	NR	NR	NR	NR	NR	90.1	0	1.3	0	41.8	1337.3	5073.5	9053.6	8525	9847.9
Residential & Commercial- MECO	kW	NR	NR	NR	NR	NR	NR	20	0	0	0	15.2	552.8	1642.9	4280.9	8044.1	5005.7

Table A12. Cumulative electric vehicles across islands and studies.

Location	Source	2011	2012	2013	2014	2015	2016	2017	2018	2019	2020	2021	2022
Oahu	EoT study	4.10E+02	8.70E+02	1.60E+03	2.32E+03	3.01E+03	3.96E+03	5.20E+03	6.55E+03	8.19E+03	9.32E+03	1.13E+04	1.38E+04
Hawaii	EoT study	4.30E+01	8.30E+01	1.03E+02	1.52E+02	1.76E+02	2.41E+02	3.50E+02	4.55E+02	6.14E+02	7.96E+02	1.02E+03	1.33E+03
Maui	EoT study	2.10E+02	3.02E+02	7.00E+02	1.19E+03	1.33E+03	1.52E+03	1.82E+03	2.09E+03	2.27E+03	2.49E+03	3.27E+03	4.51E+03
All islands	EoT study	6.63E+02	1.26E+03	2.41E+03	3.66E+03	4.52E+03	5.74E+03	7.38E+03	9.10E+03	1.11E+04	1.26E+04	1.56E+04	1.96E+04
All islands	HADA study	3.00E+02	1.25E+03	2.35E+03	3.50E+03	4.70E+03	5.85E+03	7.05E+03	8.40E+03	1.03E+04	1.38E+04	1.78E+04	2.18E+04
All islands	HNEI study					7.33E+03	1.26E+04	1.53E+04	1.76E+04	1.97E+04	2.35E+04	2.77E+04	3.29E+04
		2023	2024	2025	2026	2027	2028	2029	2030	2031	2032	2033	2034
		1.67E+04	2.01E+04	2.41E+04	2.88E+04	3.41E+04	4.02E+04	4.71E+04	5.49E+04	6.36E+04	7.33E+04	8.41E+04	9.59E+04
		1.79E+03	2.52E+03	3.65E+03	5.14E+03	6.92E+03	9.02E+03	1.11E+04	1.33E+04	1.59E+04	1.88E+04	2.20E+04	2.54E+04
		6.00E+03	7.90E+03	1.08E+04	1.49E+04	2.06E+04	2.60E+04	3.14E+04	3.87E+04	4.77E+04	5.84E+04	7.01E+04	8.19E+04
		2.45E+04	3.05E+04	3.86E+04	4.88E+04	6.16E+04	7.52E+04	8.96E+04	1.07E+05	1.27E+05	1.62E+05	1.88E+05	2.03E+05
		2.64E+04	3.14E+04	3.66E+04	4.31E+04	5.05E+04	5.90E+04	6.86E+04	7.95E+04	9.15E+04	1.05E+05	1.19E+05	1.34E+05
		3.81E+04	4.40E+04	4.87E+04	5.93E+04	7.00E+04	8.00E+04	8.78E+04	9.49E+04	1.08E+05	1.29E+05	1.40E+05	1.57E+05
		2034	2035	2036	2037	2038	2039	2040	2041	2042	2043	2044	2045
		9.59E+04	1.09E+05	1.22E+05	1.36E+05	1.54E+05	1.74E+05	1.98E+05	2.26E+05	2.54E+05	2.84E+05	3.16E+05	3.50E+05
		2.54E+04	2.94E+04	3.34E+04	3.79E+04	4.28E+04	4.82E+04	5.42E+04	6.04E+04	6.78E+04	7.53E+04	8.34E+04	9.21E+04
		8.19E+04	9.33E+04	1.05E+05	1.18E+05	1.31E+05	1.44E+05	1.57E+05	1.70E+05	1.82E+05	1.93E+05	2.05E+05	2.16E+05
		2.03E+05	2.32E+05	2.61E+05	2.92E+05	3.28E+05	3.66E+05	4.09E+05	4.56E+05	5.04E+05	5.53E+05	6.05E+05	6.59E+05
		1.34E+05	1.51E+05	1.70E+05	1.93E+05	2.19E+05	2.48E+05	2.78E+05	3.11E+05	3.46E+05	3.84E+05	4.24E+05	4.66E+05
		1.57E+05	1.72E+05	1.88E+05	2.05E+05	2.22E+05	2.38E+05	2.60E+05	-	-	-	-	-

Table A13. Cumulative projected PV penetration across island and scale. Values for 2022 also reflect the amount of cumulative PV installed through 2021. Note: HECO projections in the integrated grid report combined residential with commercial. Predictions for Kaua'i were not available. Utility-scale data does not increase in years after 2024 because data was only available for years 2022 through 2024.

Type and location	Unit	2022	2023	2024	2025	2026	2027	2028	2029	2030	2031	2032	2033	2034	2035	2036	2037	2038	2039	2040	2041	2042	2043	2044	2045	
Residential & Commercial - Oahu	MWac	644.0	681.4	701.9	723.2	744.9	766.6	788.3	809.7	831.0	851.1	870.1	887.9	905.0	921.5	937.0	951.8	966.2	980.0	993.4	1006.5	1019.1	1031.4	1042.8	1053.9	
Residential & Commercial - Hawaii	MWac	124.0	130.5	134.4	138.8	143.7	148.7	153.8	159.1	164.4	169.6	174.4	179.1	183.8	188.4	192.8	197.2	201.4	205.5	209.2	213.2	216.8	220.5	224.2	227.4	
Residential & Commercial - Maui	MWac	143.4	151.4	156.9	162.5	168.1	173.7	179.3	184.9	190.6	196.0	201.0	205.7	210.5	214.9	219.2	223.4	227.5	230.9	234.3	237.8	240.9	244.0	247.0	249.8	
Residential & Commercial - Kaua'i	MWac	35.7	37.8	39.8	41.9	44.0	46.1	48.2	50.2	52.3	54.4	56.5	58.6	60.6	62.7	64.8	66.9	69.0	71.0	73.1	75.2	77.3	79.4	81.4	83.5	
SUM - Residential & Commercial	MWac	947.1	1001.1	1033.1	1066.5	1100.8	1135.1	1169.6	1203.9	1238.2	1271.1	1301.9	1331.3	1360.0	1387.5	1413.8	1439.3	1464.0	1487.5	1510.0	1532.6	1554.0	1575.3	1595.4	1614.7	
Utility - Oahu	MWac	236.7	519.2	616.2	616.2	616.2	616.2	616.2	616.2	616.2	616.2	616.2	616.2	616.2	616.2	616.2	616.2	616.2	616.2	616.2	616.2	616.2	616.2	616.2	616.2	616.2
Utility - Hawaii	MWac	0.0	60.0	72.0	72.0	72.0	72.0	72.0	72.0	72.0	72.0	72.0	72.0	72.0	72.0	72.0	72.0	72.0	72.0	72.0	72.0	72.0	72.0	72.0	72.0	72.0
Utility - Maui	MWac	7.0	67.0	199.5	199.5	199.5	199.5	199.5	199.5	199.5	199.5	199.5	199.5	199.5	199.5	199.5	199.5	199.5	199.5	199.5	199.5	199.5	199.5	199.5	199.5	199.5
Utility - Kauai	MWac	80.0	80.0	80.0	115.7	115.7	115.7	115.7	115.7	115.7	115.7	115.7	115.7	115.7	115.7	115.7	115.7	115.7	115.7	115.7	115.7	115.7	115.7	115.7	115.7	115.7
SUM - Utility	MWac	323.7	726.2	967.7	1003.4	1003.4	1003.4	1003.4	1003.4	1003.4	1003.4	1003.4	1003.4	1003.4	1003.4	1003.4	1003.4	1003.4	1003.4	1003.4	1003.4	1003.4	1003.4	1003.4	1003.4	1003.4
Culmative PV	MWac	1270.8	1727.3	2000.8	2069.9	2104.2	2138.6	2173.0	2207.3	2241.7	2274.5	2305.4	2334.7	2363.4	2390.9	2417.2	2442.7	2467.4	2490.9	2513.5	2536.0	2557.5	2578.7	2598.9	2618.1	

Table A14. Hawaiian Electric utility-scale renewable project status board. Listing sourced on 8/8/2022.

Hawaiian Electric Renewable Project Status Board

NEWLY IN SERVICE						
Name	Island	Developer	Tech	Size	In Service	RPS % Points Contribution
Mililani I Solar, LLC	O'ahu (Mililani)	Clearway Energy Group LLC	Solar + BESS	39 MW 156 MWh (BESS)	7/31/2022	1.2

Shared Solar (Phase 2, Tranche 1 CBRE) Final Award Group Projects						
Name	Island	Developer	Tech	Size	Estimated Completion	RPS % Points Contribution
Lāna'i Solar	Lāna'i	DG Development & Acquisition	Solar + BESS	17.5 MW, 89 MWh (BESS)	2024	0.4

Stage 2 RFP Final Award Group Projects Awaiting Regulatory Approval						
Name	Island	Developer	Tech	Size	Estimated Completion	RPS % Points Contribution
Keāhole Battery Energy Storage	Hawai'i Island (Kailua-Kona)	Hawaiian Electric Company	BESS	12 MW, 12 MWh	2024	N/A
Waena BESS	Maui (Kahului)	Hawaiian Electric Company	BESS	40 MW, 160 MWh	2024	0.2

APPROVED BY REGULATORS						
Name	Island	Developer	Tech	Size	Estimated Completion	RPS % Points Contribution
AES Kuihelani	Maui (Central Maui)	AES Corporation	Solar + BESS	60 MW 240 MWh (BESS)	2023	1.9
AES Waikoloa Solar, LLC	Hawai'i Island (Waikoloa)	AES Corporation	Solar + BESS	30 MW 120 MWh (BESS)	2/2023	0.8
AES West Oahu Solar, LLC	O'ahu (West O'ahu)	AES Corporation	Solar + BESS	12.5 MW 50 MWh (BESS)	3/2023	0.4
Barbers Point Solar	O'ahu (Kapolei)	Innergex Renewable Energy Inc.	Solar + BESS	15 MW 60 MWh (BESS)	2024	0.4
Hale Kuawehi Solar LLC	Hawai'i Island (Waimea)	Innergex Renewable Energy Inc.	Solar + BESS	30 MW 120 MWh (BESS)	2023	0.8

BESS = Battery Energy Storage System



*Table A14 (cont.). Hawaiian Electric's utility-scale renewable project status board.
Listing sourced on 9/22/2022.*

APPROVED BY REGULATORS (Cont'd)						
Name	Island	Developer	Tech	Size	Estimated Completion	RPS % Points Contribution
Ho'ohana Solar 1, LLC	O'ahu (Kunia)	Hanwha Energy USA Holdings Corp (174 Power Global)	Solar + BESS	52 MW 208 MWh (BESS)	2024	1.4
Kahana Solar	Maui (Napili - Honokowai)	Innergex Renewable Energy Inc.	Solar + BESS	20 MW, 80 MWh (BESS)	2024	0.7
Kamaole Solar	Maui (Kihei)	Potentia Renewables	Solar + BESS	40 MW, 160 MWh (BESS)	2024	1.4
Kapolei Energy Storage	O'ahu (Barbers Point Harbor)	Plus Power LLC	BESS	185 MW, 565 MWh	5/2023	0.1
Kūpono Solar	O'ahu (Ewa)	Kūpono Solar Development Company, LLC	Solar + BESS	42 MW, 168 MWh (BESS)	2024	0.85
Mountain View Solar	O'ahu (Wai'anae)	AES Corporation	Solar + BESS	7 MW, 35 MWh (BESS)	2023	0.3
Paeahu Solar LLC	Maui (Wailea)	Innergex Renewable Energy Inc.	Solar + BESS	15 MW 60 MWh (BESS)	2024	0.5
Puna Geothermal Venture	Hawai'i Island (Puna)	Ormat Technologies Inc.	Geothermal	46 MW	TBD	~4.0
Waiawa Phase 2 Solar	O'ahu (Waiawa)	AES Corporation	Solar + BESS	30 MW, 240 MWh (BESS)	2024	1.2
Waiawa Solar Power LLC	O'ahu (Waiawa)	Clearway Energy Group LLC	Solar + BESS	36 MW 144 MWh (BESS)	2/2023	1.2

BEES = Battery Energy Storage System



Table A15. Cumulative projected PV energy storage to be installed across island and scale. Values for 2022 also include the amount of cumulative PV energy storage installed through 2021. HECO projections in the integrated grid report combined residential with commercial. Utility-scale data does not increase in years after 2025 due to an absence of proposed projects.

Scale - Island	Unit	2022	2023	2024	2025	2026	2027	2028	2029	2030	2031	2032	2033
Res. & Com. - Oahu	MWh	1.80E+02	2.53E+02	2.84E+02	3.18E+02	3.52E+02	3.87E+02	4.23E+02	4.58E+02	4.93E+02	5.27E+02	5.58E+02	5.87E+02
Res. & Com. - Hawaii	MWh	5.59E+01	7.05E+01	7.70E+01	8.42E+01	9.23E+01	1.01E+02	1.09E+02	1.18E+02	1.26E+02	1.35E+02	1.42E+02	1.50E+02
Res. & Com. - Maui	MWh	9.07E+01	1.09E+02	1.19E+02	1.30E+02	1.41E+02	1.51E+02	1.62E+02	1.72E+02	1.82E+02	1.92E+02	2.01E+02	2.10E+02
Res. & Com. - Kauai	MWh	2.56E+01	3.07E+01	3.57E+01	4.08E+01	4.59E+01	5.10E+01	5.61E+01	6.11E+01	6.62E+01	7.13E+01	7.64E+01	8.15E+01
SUM - Res. & Com.	MWh	3.52E+02	4.63E+02	5.16E+02	5.73E+02	6.32E+02	6.90E+02	7.50E+02	8.09E+02	8.68E+02	9.25E+02	9.78E+02	1.03E+03
Utility - Oahu	MWh	1.56E+02	1.12E+03	1.63E+03	1.63E+03	1.63E+03	1.63E+03	1.63E+03	1.63E+03	1.63E+03	1.63E+03	1.63E+03	1.63E+03
Utility - Hawaii	MWh	0.00E+00	2.40E+02	2.52E+02	2.52E+02	2.52E+02	2.52E+02	2.52E+02	2.52E+02	2.52E+02	2.52E+02	2.52E+02	2.52E+02
Utility - Maui	MWh	2.64E+01	2.66E+02	8.15E+02	8.15E+02	8.15E+02	8.15E+02	8.15E+02	8.15E+02	8.15E+02	8.15E+02	8.15E+02	8.15E+02
Utility - Kauai	MWh	1.57E+02	1.57E+02	1.57E+02	2.27E+02	2.27E+02	2.27E+02	2.27E+02	2.27E+02	2.27E+02	2.27E+02	2.27E+02	2.27E+02
SUM - Utility	MWh	3.39E+02	1.78E+03	2.85E+03	2.92E+03	2.92E+03	2.92E+03	2.92E+03	2.92E+03	2.92E+03	2.92E+03	2.92E+03	2.92E+03
2034	2035	2036	2037	2038	2039	2040	2041	2042	2043	2044	2045		
6.15E+02	6.42E+02	6.67E+02	6.91E+02	7.14E+02	7.36E+02	7.57E+02	7.77E+02	7.96E+02	8.14E+02	8.32E+02	8.48E+02		
1.57E+02	1.64E+02	1.71E+02	1.78E+02	1.84E+02	1.91E+02	1.97E+02	2.03E+02	2.08E+02	2.14E+02	2.19E+02	2.24E+02		
2.18E+02	2.26E+02	2.33E+02	2.41E+02	2.47E+02	2.54E+02	2.60E+02	2.67E+02	2.72E+02	2.77E+02	2.84E+02	2.89E+02		
8.65E+01	9.16E+01	9.67E+01	1.02E+02	1.07E+02	1.12E+02	1.17E+02	1.22E+02	1.27E+02	1.32E+02	1.37E+02	1.42E+02		
1.08E+03	1.12E+03	1.17E+03	1.21E+03	1.25E+03	1.29E+03	1.33E+03	1.37E+03	1.40E+03	1.45E+03	1.47E+03	1.50E+03		
1.63E+03	1.63E+03	1.63E+03	1.63E+03	1.63E+03	1.63E+03	1.63E+03	1.63E+03	1.63E+03	1.63E+03	1.63E+03	1.63E+03	1.63E+03	1.63E+03
2.52E+02	2.52E+02	2.52E+02	2.52E+02	2.52E+02	2.52E+02	2.52E+02	2.52E+02	2.52E+02	2.52E+02	2.52E+02	2.52E+02	2.52E+02	2.52E+02
8.15E+02	8.15E+02	8.15E+02	8.15E+02	8.15E+02	8.15E+02	8.15E+02	8.15E+02	8.15E+02	8.15E+02	8.15E+02	8.15E+02	8.15E+02	8.15E+02
2.27E+02	2.27E+02	2.27E+02	2.27E+02	2.27E+02	2.27E+02	2.27E+02	2.27E+02	2.27E+02	2.27E+02	2.27E+02	2.27E+02	2.27E+02	2.27E+02
2.92E+03	2.92E+03	2.92E+03	2.92E+03	2.92E+03	2.92E+03	2.92E+03	2.92E+03	2.92E+03	2.92E+03	2.92E+03	2.92E+03	2.92E+03	2.92E+03

Table A16. Predicted disposal loading rates from residential PV modules on O'ahu.

Residential PV Panel Disposal - Oahu																	
Component	unit	2025	2026	2027	2028	2029	2030	2031	2032	2033	2034	2035	2036	2037	2038	2039	2040
Loading	MWac	0.738	0.246	0.943	2.993	4.92	6.56	15.99	37.82	73.44	40.3	32.14	34.62	20.37	16.74	15.48	30.66
PV material	kg	6.92E+04	2.31E+04	8.84E+04	2.80E+05	4.61E+05	6.15E+05	1.50E+06	3.54E+06	6.88E+06	3.78E+06	3.01E+06	3.24E+06	1.91E+06	1.57E+06	1.45E+06	2.87E+06
Panels	#	3.21E+03	1.07E+03	4.11E+03	1.30E+04	2.14E+04	2.86E+04	6.97E+04	1.65E+05	3.20E+05	1.76E+05	1.40E+05	1.51E+05	8.87E+04	7.29E+04	6.74E+04	1.34E+05
Glass	kg	4.73E+04	1.58E+04	6.05E+04	1.92E+05	3.16E+05	4.21E+05	1.03E+06	2.43E+06	4.71E+06	2.58E+06	2.06E+06	2.22E+06	1.31E+06	1.07E+06	9.93E+05	1.97E+06
Aluminum	kg	1.20E+04	4.01E+03	1.54E+04	4.88E+04	8.02E+04	1.07E+05	2.61E+05	6.17E+05	1.20E+06	6.57E+05	5.24E+05	5.65E+05	3.32E+05	2.73E+05	2.52E+05	5.00E+05
EVA	kg	3.99E+03	1.33E+03	5.10E+03	1.62E+04	2.66E+04	3.55E+04	8.65E+04	2.05E+05	3.97E+05	2.18E+05	1.74E+05	1.87E+05	1.10E+05	9.05E+04	8.37E+04	1.66E+05
Si	kg	2.01E+03	6.70E+02	2.57E+03	8.15E+03	1.34E+04	1.79E+04	4.36E+04	1.03E+05	2.00E+05	1.10E+05	8.75E+04	9.43E+04	5.55E+04	4.56E+04	4.22E+04	8.35E+04
PVF/PET	kg	1.17E+03	3.90E+02	1.50E+03	4.75E+03	7.81E+03	1.04E+04	2.54E+04	6.00E+04	1.17E+05	6.40E+04	5.10E+04	5.49E+04	3.23E+04	2.66E+04	2.46E+04	4.87E+04
Cu	kg	4.68E+02	1.56E+02	5.98E+02	1.90E+03	3.12E+03	4.16E+03	1.01E+04	2.40E+04	4.66E+04	2.56E+04	2.04E+04	2.20E+04	1.29E+04	1.06E+04	9.82E+03	1.94E+04
Mg	kg	3.93E+02	1.31E+02	5.03E+02	1.60E+03	2.62E+03	3.50E+03	8.52E+03	2.02E+04	3.91E+04	2.15E+04	1.71E+04	1.85E+04	1.09E+04	8.92E+03	8.25E+03	1.63E+04
Pb	kg	3.37E+01	1.12E+01	4.31E+01	1.37E+02	2.25E+02	3.00E+02	7.31E+02	1.73E+03	3.36E+03	1.84E+03	1.47E+03	1.58E+03	9.31E+02	7.65E+02	7.07E+02	1.40E+03
Sn	kg	3.17E+01	1.06E+01	4.06E+01	1.29E+02	2.12E+02	2.82E+02	6.88E+02	1.63E+03	3.16E+03	1.73E+03	1.38E+03	1.49E+03	8.76E+02	7.20E+02	6.66E+02	1.32E+03
Ag	kg	1.46E+02	4.86E+01	1.86E+02	5.91E+02	9.72E+02	1.30E+03	3.16E+03	7.47E+03	1.45E+04	7.96E+03	6.35E+03	6.84E+03	4.02E+03	3.31E+03	3.06E+03	6.06E+03
Ni	kg	6.49E+01	2.16E+01	8.30E+01	2.63E+00	4.33E+00	5.77E+00	1.41E+01	3.33E+01	6.46E+01	3.55E+01	2.83E+01	3.05E+01	1.79E+01	1.47E+01	1.36E+01	2.70E+01
Zn	kg	6.76E+03	2.25E+03	8.64E+03	2.74E+02	4.51E+02	6.01E+02	1.46E+01	3.46E+01	6.73E+01	3.69E+01	2.94E+01	3.17E+01	1.87E+01	1.53E+01	1.42E+01	2.81E+01

Table A17. Predicted disposal loading rates from residential PV modules in Hawai'i County.

Residential PV Panel Disposal - Hawaii																	
Component	unit	2025	2026	2027	2028	2029	2030	2031	2032	2033	2034	2035	2036	2037	2038	2039	2040
Loading	MWac	0.14	0.05	0.18	0.58	0.96	1.28	3.12	7.05	9.17	10.55	12.28	8.42	4.71	4.55	4.93	4.62
PV material	kg	1.35E+04	4.50E+03	1.72E+04	5.47E+04	9.00E+04	1.20E+05	2.92E+05	6.60E+05	8.60E+05	9.89E+05	1.15E+06	7.89E+05	4.41E+05	4.26E+05	4.62E+05	4.33E+05
Panels	#	6.27E+02	2.09E+02	8.01E+02	2.54E+03	4.18E+03	5.58E+03	1.36E+04	3.07E+04	4.00E+04	4.60E+04	5.35E+04	3.67E+04	2.05E+04	1.98E+04	2.15E+04	2.01E+04
Glass	kg	9.24E+03	3.08E+03	1.18E+04	3.75E+04	6.16E+04	8.21E+04	2.00E+05	4.52E+05	5.88E+05	6.77E+05	7.88E+05	5.40E+05	3.02E+05	2.92E+05	3.16E+05	2.96E+05
Aluminum	kg	2.35E+03	7.83E+02	3.00E+03	9.52E+03	1.57E+04	2.09E+04	5.09E+04	1.15E+05	1.50E+05	1.72E+05	2.00E+05	1.37E+05	7.68E+04	7.42E+04	8.04E+04	7.53E+04
EVA	kg	7.79E+02	2.60E+02	9.95E+02	3.16E+03	5.19E+03	6.92E+03	1.69E+04	3.81E+04	4.96E+04	5.71E+04	6.64E+04	4.55E+04	2.55E+04	2.46E+04	2.67E+04	2.50E+04
Si	kg	1.54E+02	5.15E+01	1.97E+02	6.26E+02	1.03E+03	1.37E+03	3.34E+03	7.55E+03	9.83E+03	1.13E+04	1.32E+04	9.03E+03	5.05E+03	4.88E+03	5.29E+03	4.95E+03
PVF/PET	kg	2.29E+02	7.62E+01	2.92E+02	9.27E+02	1.52E+03	2.03E+03	4.95E+03	1.12E+04	1.46E+04	1.67E+04	1.95E+04	1.34E+04	7.47E+03	7.22E+03	7.82E+03	7.33E+03
Cu	kg	9.13E+01	3.04E+01	1.17E+02	3.70E+02	6.09E+02	8.12E+02	1.98E+03	4.47E+03	5.82E+03	6.69E+03	7.79E+03	5.34E+03	2.99E+03	2.89E+03	3.13E+03	2.93E+03
Mg	kg	7.68E+01	2.56E+01	9.81E+01	3.11E+02	5.12E+02	6.82E+02	1.66E+03	3.75E+03	4.89E+03	5.62E+03	6.55E+03	4.49E+03	2.51E+03	2.43E+03	2.63E+03	2.46E+03
Pb	kg	6.58E+00	2.19E+00	8.41E+00	2.67E+01	4.39E+01	5.85E+01	1.43E+02	3.22E+02	4.19E+02	4.82E+02	5.61E+02	3.85E+02	2.15E+02	2.08E+02	2.25E+02	2.11E+02
Sn	kg	6.19E+00	2.06E+00	7.91E+00	2.51E+01	4.13E+01	5.51E+01	1.34E+02	3.03E+02	3.95E+02	4.54E+02	5.28E+02	3.62E+02	2.03E+02	1.96E+02	2.12E+02	1.99E+02
Ag	kg	2.84E+01	9.48E+00	3.63E+01	1.15E+02	1.90E+02	2.53E+02	6.16E+02	1.39E+03	1.81E+03	2.08E+03	2.43E+03	1.66E+03	9.30E+02	8.99E+02	9.74E+02	9.12E+02
Ni	kg	1.27E+01	4.22E+02	1.62E+01	5.14E+01	8.44E+01	1.13E+00	2.74E+00	6.20E+00	8.07E+00	9.28E+00	1.08E+01	7.41E+00	4.14E+00	4.00E+00	4.34E+00	4.06E+00
Zn	kg	1.32E+03	4.40E+04	1.69E+03	5.35E+03	8.79E+03	1.17E+02	2.86E+02	6.45E+02	8.40E+02	9.66E+02	1.13E+01	7.71E+02	4.31E+02	4.17E+02	4.52E+02	4.23E+02

Table A18. Predicted disposal loading rates from residential PV modules on Maui.

		Panels Residential – Maui															
Component	unit	2025	2026	2027	2028	2029	2030	2031	2032	2033	2034	2035	2036	2037	2038	2039	2040
Loading	MWac	0.162	0.054	0.207	0.657	1.08	1.44	3.51	8.794	8.227	10.204	12.705	12.928	3.892	2.26	5.13	6.63
PV material	kg	1.52E+04	5.06E+03	1.94E+04	6.16E+04	1.01E+05	1.35E+05	3.29E+05	8.24E+05	7.71E+05	9.56E+05	1.19E+06	1.21E+06	3.65E+05	2.12E+05	4.81E+05	6.21E+05
Panels	#	7.06E+02	2.35E+02	9.02E+02	2.86E+03	4.70E+03	6.27E+03	1.53E+04	3.83E+04	3.58E+04	4.44E+04	5.53E+04	5.63E+04	1.70E+04	9.84E+03	2.23E+04	2.89E+04
Glass	kg	1.04E+04	3.46E+03	1.33E+04	4.21E+04	6.93E+04	9.24E+04	2.25E+05	5.64E+05	5.28E+05	6.55E+05	8.15E+05	8.29E+05	2.50E+05	1.45E+05	3.29E+05	4.25E+05
Aluminum	kg	2.64E+03	8.81E+02	3.38E+03	1.07E+04	1.76E+04	2.35E+04	5.72E+04	1.43E+05	1.34E+05	1.66E+05	2.07E+05	2.11E+05	6.35E+04	3.69E+04	8.37E+04	1.08E+05
EVA	kg	8.76E+02	2.92E+02	1.12E+03	3.55E+03	5.84E+03	7.79E+03	1.90E+04	4.76E+04	4.45E+04	5.52E+04	6.87E+04	6.99E+04	2.10E+04	1.22E+04	2.77E+04	3.59E+04
Si	kg	4.41E+02	1.47E+02	5.64E+02	1.79E+03	2.94E+03	3.92E+03	9.56E+03	2.40E+04	2.24E+04	2.78E+04	3.46E+04	3.52E+04	1.06E+04	6.16E+03	1.40E+04	1.81E+04
PVF/PET	kg	2.57E+02	8.57E+01	3.29E+02	1.04E+03	1.71E+03	2.29E+03	5.57E+03	1.40E+04	1.31E+04	1.62E+04	2.02E+04	2.05E+04	6.18E+03	3.59E+03	8.14E+03	1.05E+04
Cu	kg	1.03E+02	3.43E+01	1.31E+02	4.17E+02	6.85E+02	9.13E+02	2.23E+03	5.58E+03	5.22E+03	6.47E+03	8.06E+03	8.20E+03	2.47E+03	1.43E+03	3.25E+03	4.21E+03
Mg	kg	8.63E+01	2.88E+01	1.10E+02	3.50E+02	5.76E+02	7.68E+02	1.87E+03	4.69E+03	4.38E+03	5.44E+03	6.77E+03	6.89E+03	2.07E+03	1.20E+03	2.73E+03	3.53E+03
Pb	kg	7.40E+00	2.47E+00	9.46E+00	3.00E+01	4.94E+01	6.58E+01	1.60E+02	4.02E+02	3.76E+02	4.66E+02	5.81E+02	5.91E+02	1.78E+02	1.03E+02	2.34E+02	3.03E+02
Sn	kg	6.97E+00	2.32E+00	8.90E+00	2.83E+01	4.65E+01	6.19E+01	1.51E+02	3.78E+02	3.54E+02	4.39E+02	5.46E+02	5.56E+02	1.67E+02	9.72E+01	2.21E+02	2.85E+02
Ag	kg	3.20E+01	1.07E+01	4.09E+01	1.30E+02	2.13E+02	2.84E+02	6.93E+02	1.74E+03	1.62E+03	2.02E+03	2.51E+03	2.55E+03	7.69E+02	4.46E+02	1.01E+03	1.31E+03
Ni	kg	1.43E-01	4.75E-02	1.82E-01	5.78E-01	9.50E-01	1.27E+00	3.09E+00	7.74E+00	7.24E+00	8.98E+00	1.12E+01	1.14E+01	3.42E+00	1.99E+00	4.51E+00	5.83E+00
Zn	kg	1.48E-03	4.95E-04	1.90E-03	6.02E-03	9.89E-03	1.32E-02	3.22E-02	8.06E-02	7.54E-02	9.35E-02	1.16E-01	1.18E-01	3.57E-02	2.07E-02	4.70E-02	6.07E-02

Table A19. Predicted disposal loading rates from residential PV modules on Kaua'i.

		Residential PV Panel Disposal – Kauai															
Component	unit	2025	2026	2027	2028	2029	2030	2031	2032	2033	2034	2035	2036	2037	2038	2039	2040
Loading	MWac	0.00	0.00	0.00	0.00	0.00	0.00	1.94	1.13	2.71	2.52	3.36	1.59	1.58	1.43	0.98	1.40
PV material	kg	0.00E+00	0.00E+00	0.00E+00	0.00E+00	0.00E+00	0.00E+00	1.82E+05	1.06E+05	2.54E+05	2.36E+05	3.15E+05	1.49E+05	1.48E+05	1.34E+05	9.15E+04	1.31E+05
Panels	#	0.00E+00	0.00E+00	0.00E+00	0.00E+00	0.00E+00	0.00E+00	8.45E+03	4.93E+03	1.18E+04	1.10E+04	1.46E+04	6.93E+03	6.88E+03	6.23E+03	4.25E+03	6.10E+03
Glass	kg	0.00E+00	0.00E+00	0.00E+00	0.00E+00	0.00E+00	0.00E+00	1.24E+05	7.25E+04	1.74E+05	1.62E+05	2.16E+05	1.02E+05	1.01E+05	9.17E+04	6.26E+04	8.98E+04
Aluminum	kg	0.00E+00	0.00E+00	0.00E+00	0.00E+00	0.00E+00	0.00E+00	3.16E+04	1.84E+04	4.42E+04	4.11E+04	5.48E+04	2.59E+04	2.58E+04	2.33E+04	1.59E+04	2.28E+04
EVA	kg	0.00E+00	0.00E+00	0.00E+00	0.00E+00	0.00E+00	0.00E+00	1.05E+04	6.12E+03	1.47E+04	1.36E+04	1.82E+04	8.60E+03	8.55E+03	7.73E+03	5.28E+03	7.57E+03
Si	kg	0.00E+00	0.00E+00	0.00E+00	0.00E+00	0.00E+00	0.00E+00	5.28E+03	3.08E+03	7.38E+03	6.86E+03	9.15E+03	4.33E+03	4.30E+03	3.90E+03	2.66E+03	3.81E+03
PVF/PET	kg	0.00E+00	0.00E+00	0.00E+00	0.00E+00	0.00E+00	0.00E+00	3.08E+03	1.79E+03	4.30E+03	4.00E+03	5.33E+03	2.52E+03	2.51E+03	2.27E+03	1.55E+03	2.22E+03
Cu	kg	0.00E+00	0.00E+00	0.00E+00	0.00E+00	0.00E+00	0.00E+00	1.23E+03	7.17E+02	1.72E+03	1.60E+03	2.13E+03	1.01E+03	1.00E+03	9.07E+02	6.19E+02	8.88E+02
Mg	kg	0.00E+00	0.00E+00	0.00E+00	0.00E+00	0.00E+00	0.00E+00	1.03E+03	6.03E+02	1.44E+03	1.34E+03	1.79E+03	8.47E+02	8.42E+02	7.62E+02	5.20E+02	7.46E+02
Pb	kg	0.00E+00	0.00E+00	0.00E+00	0.00E+00	0.00E+00	0.00E+00	8.87E+01	5.17E+01	1.24E+02	1.15E+02	1.54E+02	7.27E+01	7.22E+01	6.54E+01	4.46E+01	6.40E+01
Sn	kg	0.00E+00	0.00E+00	0.00E+00	0.00E+00	0.00E+00	0.00E+00	8.34E+01	4.86E+01	1.17E+02	1.08E+02	1.45E+02	6.84E+01	6.80E+01	6.15E+01	4.20E+01	6.02E+01
Ag	kg	0.00E+00	0.00E+00	0.00E+00	0.00E+00	0.00E+00	0.00E+00	3.83E+02	2.23E+02	5.35E+02	4.98E+02	6.64E+02	3.14E+02	3.12E+02	2.82E+02	1.93E+02	2.76E+02
Ni	kg	0.00E+00	0.00E+00	0.00E+00	0.00E+00	0.00E+00	0.00E+00	3.83E+02	2.23E+02	5.35E+02	4.98E+02	6.64E+02	3.14E+02	3.12E+02	2.82E+02	1.93E+02	2.76E+02
Zn	kg	0.00E+00	0.00E+00	0.00E+00	0.00E+00	0.00E+00	0.00E+00	1.71E+00	9.95E-01	2.38E+00	2.22E+00	2.96E+00	1.40E+00	1.39E+00	1.26E+00	8.59E-01	1.23E+00

Table A20. Predicted disposal loading rates from commercial PV modules on O‘ahu.

		Panels Commercial - Oahu																		
Component	unit	2025	2026	2027	2028	2029	2030	2031	2032	2033	2034	2035	2036	2037	2038	2039	2040			
Loading	MWac	0.504	0.168	0.644	2.044	3.36	4.48	10.92	26.67	28.56	21.7	27.86	33.38	42.33	14.26	15.92	21.34			
PV material	kg	4.72E+04	1.57E+04	6.03E+04	1.92E+05	3.15E+05	4.20E+05	1.02E+06	2.50E+06	2.68E+06	2.03E+06	2.61E+06	3.13E+06	3.97E+06	1.34E+06	1.49E+06	2.00E+06			
Panels	#	2.20E+03	7.32E+02	2.81E+03	8.90E+03	1.46E+04	1.95E+04	4.76E+04	1.16E+05	1.24E+05	9.45E+04	1.21E+05	1.45E+05	1.84E+05	6.21E+04	6.93E+04	9.30E+04			
Glass	kg	3.23E+04	1.08E+04	4.13E+04	1.31E+05	2.16E+05	2.87E+05	7.00E+05	1.71E+06	1.83E+06	1.39E+06	1.79E+06	2.14E+06	2.72E+06	9.15E+05	1.02E+06	1.37E+06			
Aluminum	kg	8.22E+03	2.74E+03	1.05E+04	3.33E+04	5.48E+04	7.31E+04	1.78E+05	4.35E+05	4.66E+05	3.54E+05	4.54E+05	5.44E+05	6.90E+05	2.33E+05	2.60E+05	3.48E+05			
EVA	kg	2.73E+03	9.09E+02	3.48E+03	1.11E+04	1.82E+04	2.42E+04	5.91E+04	1.44E+05	1.54E+05	1.17E+05	1.51E+05	1.81E+05	2.29E+05	7.71E+04	8.61E+04	1.15E+05			
Si	kg	1.37E+03	4.58E+02	1.75E+03	5.57E+03	9.15E+03	1.22E+04	2.97E+04	7.26E+04	7.78E+04	5.91E+04	7.59E+04	9.09E+04	1.15E+05	3.88E+04	4.34E+04	5.81E+04			
PVF/PET	kg	8.00E+02	2.67E+02	1.02E+03	3.24E+03	5.33E+03	7.11E+03	1.73E+04	4.23E+04	4.53E+04	3.44E+04	4.42E+04	5.30E+04	6.72E+04	2.26E+04	2.53E+04	3.39E+04			
Cu	kg	3.20E+02	1.07E+02	4.09E+02	1.30E+03	2.13E+03	2.84E+03	6.93E+03	1.69E+04	1.81E+04	1.38E+04	1.77E+04	2.12E+04	2.69E+04	9.05E+03	1.01E+04	1.35E+04			
Mg	kg	2.69E+02	8.95E+01	3.43E+02	1.09E+03	1.79E+03	2.39E+03	5.82E+03	1.42E+04	1.52E+04	1.16E+04	1.48E+04	1.78E+04	2.26E+04	7.60E+03	8.49E+03	1.14E+04			
Pb	kg	2.30E+01	7.68E+00	2.94E+01	9.34E+01	1.54E+02	2.05E+02	4.99E+02	1.22E+03	1.31E+03	9.92E+02	1.27E+03	1.53E+03	1.93E+03	6.52E+02	7.28E+02	9.75E+02			
Su	kg	2.17E+01	7.23E+00	2.77E+01	8.79E+01	1.45E+02	1.93E+02	4.70E+02	1.15E+03	1.23E+03	9.33E+02	1.20E+03	1.44E+03	1.82E+03	6.13E+02	6.85E+02	9.18E+02			
Ag	kg	9.95E+01	3.32E+01	1.27E+02	4.04E+02	6.64E+02	8.85E+02	2.16E+03	5.27E+03	5.64E+03	4.29E+03	5.50E+03	6.59E+03	8.36E+03	2.82E+03	3.14E+03	4.21E+03			
Ni	kg	4.43E-01	1.48E-01	5.67E-01	1.80E+00	2.96E+00	3.94E+00	9.61E+00	2.35E+01	2.51E+01	1.91E+01	2.45E+01	2.94E+01	3.72E+01	1.25E+01	1.40E+01	1.88E+01			
Zn	kg	4.62E-03	1.54E-03	5.90E-03	1.87E-02	3.08E-02	4.10E-02	1.00E-01	2.44E-01	2.62E-01	1.99E-01	2.55E-01	3.06E-01	3.88E-01	1.31E-01	1.46E-01	1.95E-01			

Table A21. Predicted disposal loading rates from commercial PV modules in Hawai'i County.

		Panels Commercial - Hawaii																		
Component	unit	2025	2026	2027	2028	2029	2030	2031	2032	2033	2034	2035	2036	2037	2038	2039	2040			
Loading	MWac	0.126	0.036	0.138	0.438	0.72	0.96	2.34	6.195	4.727	2.95	5.818	3.28	3.79	2.45	1.07	2.38			
PV material	kg	1.18E+04	3.37E+03	1.29E+04	4.10E+04	6.75E+04	9.00E+04	2.19E+05	5.81E+05	4.43E+05	2.76E+05	5.45E+05	3.07E+05	3.55E+05	2.30E+05	1.00E+05	2.23E+05			
Panels	#	5.49E+02	1.57E+02	6.01E+02	1.91E+03	3.14E+03	4.18E+03	1.02E+04	2.70E+04	2.06E+04	1.28E+04	2.53E+04	1.43E+04	1.65E+04	1.07E+04	4.66E+03	1.04E+04			
Glass	kg	8.08E+03	2.31E+03	8.85E+03	2.81E+04	4.62E+04	6.16E+04	1.50E+05	3.97E+05	3.03E+05	1.89E+05	3.73E+05	2.10E+05	2.43E+05	1.57E+05	6.86E+04	1.53E+05			
Aluminum	kg	2.05E+03	5.87E+02	2.25E+03	7.14E+03	1.17E+04	1.57E+04	3.82E+04	1.01E+05	7.71E+04	4.81E+04	9.49E+04	5.35E+04	6.18E+04	4.00E+04	1.74E+04	3.88E+04			
EVA	kg	6.81E+02	1.95E+02	7.46E+02	2.37E+03	3.89E+03	5.19E+03	1.27E+04	3.35E+04	2.56E+04	1.60E+04	3.15E+04	1.77E+04	2.05E+04	1.33E+04	5.79E+03	1.29E+04			
Si	kg	3.43E+02	9.81E+01	3.76E+02	1.19E+03	1.96E+03	2.61E+03	6.37E+03	1.69E+04	1.29E+04	8.04E+03	1.58E+04	8.93E+03	1.03E+04	6.67E+03	2.91E+03	6.48E+03			
PVF/PET	kg	2.00E+02	5.71E+01	2.19E+02	6.95E+02	1.14E+03	1.52E+03	3.71E+03	9.83E+03	7.50E+03	4.68E+03	9.23E+03	5.21E+03	6.01E+03	3.89E+03	1.70E+03	3.78E+03			
Cu	kg	7.99E+01	2.28E+01	8.75E+01	2.78E+02	4.57E+02	6.09E+02	1.48E+03	3.93E+03	3.00E+03	1.87E+03	3.69E+03	2.08E+03	2.40E+03	1.55E+03	6.79E+02	1.51E+03			
Mg	kg	6.72E+01	1.92E+01	7.36E+01	2.33E+02	3.84E+02	5.12E+02	1.25E+03	3.30E+03	2.52E+03	1.57E+03	3.10E+03	1.75E+03	2.02E+03	1.31E+03	5.70E+02	1.27E+03			
Pb	kg	5.76E+00	1.65E+00	6.31E+00	2.00E+01	3.29E+01	4.39E+01	1.07E+02	2.83E+02	2.16E+02	1.35E+02	2.66E+02	1.50E+02	1.73E+02	1.12E+02	4.89E+01	1.09E+02			
Su	kg	5.42E+00	1.55E+00	5.94E+00	1.88E+01	3.10E+01	4.13E+01	1.01E+02	2.66E+02	2.03E+02	1.27E+02	2.50E+02	1.41E+02	1.63E+02	1.05E+02	4.60E+01	1.02E+02			
Ag	kg	2.49E+01	7.11E+00	2.73E+01	8.65E+01	1.42E+02	1.90E+02	4.62E+02	1.22E+03	9.34E+02	5.83E+02	1.15E+03	6.48E+02	7.48E+02	4.84E+02	2.11E+02	4.70E+02			
Ni	kg	1.11E-01	3.17E-02	1.21E-01	3.83E-01	6.33E-01	8.44E-01	2.06E+00	5.45E+00	4.16E+00	2.60E+00	5.12E+00	2.89E+00	3.33E+00	2.16E+00	9.41E-01	2.09E+00			
Zn	kg	1.15E-03	3.30E-04	1.26E-03	4.01E-03	6.60E-03	8.79E-03	2.14E-02	5.67E-02	4.33E-02	2.70E-02	5.33E-02	3.00E-02	3.47E-02	2.24E-02	9.80E-03	2.18E-02			

Table A22. Predicted disposal loading rates from commercial PV modules on Maui.

		Panels Commercial - Maui																		
Component	unit	2025	2026	2027	2028	2029	2030	2031	2032	2033	2034	2035	2036	2037	2038	2039	2040			
Loading	MWac	0.126	0.042	0.161	0.511	0.84	1.12	2.73	6.966	4.273	3.396	6.331	7.236	5.408	10.74	3.87	0.37			
PV material	kg	1.18E+04	3.94E+03	1.51E+04	4.79E+04	7.87E+04	1.05E+05	2.56E+05	6.53E+05	4.00E+05	3.18E+05	5.93E+05	6.78E+05	5.07E+05	1.01E+06	3.63E+05	3.47E+04			
Panels	#	5.49E+02	1.83E+02	7.01E+02	2.23E+03	3.66E+03	4.88E+03	1.19E+04	3.03E+04	1.86E+04	1.48E+04	2.76E+04	3.15E+04	2.36E+04	4.68E+04	1.69E+04	1.61E+03			
Glass	kg	8.08E+03	2.69E+03	1.03E+04	3.28E+04	5.39E+04	7.18E+04	1.75E+05	4.47E+05	2.74E+05	2.18E+05	4.06E+05	4.64E+05	3.47E+05	6.89E+05	2.48E+05	2.37E+04			
Aluminum	kg	2.05E+03	6.85E+02	2.63E+03	8.33E+03	1.37E+04	1.83E+04	4.45E+04	1.14E+05	6.97E+04	5.54E+04	1.03E+05	1.18E+05	8.82E+04	1.75E+05	6.31E+04	6.03E+03			
EVA	kg	6.81E+02	2.27E+02	8.71E+02	2.76E+03	4.54E+03	6.06E+03	1.48E+04	3.77E+04	2.31E+04	1.84E+04	3.42E+04	3.91E+04	2.92E+04	5.81E+04	2.09E+04	2.00E+03			
Si	kg	3.43E+02	1.14E+02	4.39E+02	1.39E+03	2.29E+03	3.05E+03	7.44E+03	1.90E+04	1.16E+04	9.25E+03	1.72E+04	1.97E+04	1.47E+04	2.93E+04	1.05E+04	1.01E+03			
PVF/PET	kg	2.00E+02	6.67E+01	2.56E+02	8.11E+02	1.33E+03	1.78E+03	4.33E+03	1.11E+04	6.78E+03	5.39E+03	1.00E+04	1.15E+04	8.58E+03	1.70E+04	6.14E+03	5.87E+02			
Cu	kg	7.99E+01	2.66E+01	1.02E+02	3.24E+02	5.33E+02	7.10E+02	1.73E+03	4.42E+03	2.15E+03	4.02E+03	4.59E+03	4.89E+03	3.43E+03	6.81E+03	2.45E+03	3.35E+02			
Mg	kg	6.72E+01	2.24E+01	8.58E+01	2.72E+02	4.48E+02	5.97E+02	1.46E+03	3.71E+03	2.28E+03	1.81E+03	3.37E+03	3.86E+03	2.88E+03	5.72E+03	2.06E+03	1.97E+02			
Pb	kg	5.76E+00	1.92E+00	7.36E+00	2.34E+01	3.84E+01	5.12E+01	1.25E+02	3.18E+02	1.95E+02	1.55E+02	2.89E+02	3.31E+02	2.47E+02	4.91E+02	1.77E+02	1.69E+01			
Su	kg	5.42E+00	1.81E+00	6.93E+00	2.20E+01	3.61E+01	4.82E+01	1.17E+02	3.00E+02	1.84E+02	1.46E+02	2.72E+02	3.11E+02	2.33E+02	4.62E+02	1.66E+02	1.59E+01			
Ag	kg	2.49E+01	8.29E+00	3.18E+01	1.01E+02	1.66E+02	2.21E+02	5.39E+02	1.38E+03	8.44E+02	6.71E+02	1.23E+03	1.43E+03	1.07E+03	2.12E+03	7.64E+02	7.31E+01			
Ni	kg	1.11E-01	3.69E-02	1.42E-01	4.50E-01	7.39E-01	9.85E-01	2.40E+00	6.13E+00	3.76E+00	2.99E+00	5.57E+00	6.37E+00	4.76E+00	9.45E+00	3.40E+00	3.25E-01			
Zn	kg	1.15E-03	3.85E-04	1.47E-03	4.68E-03	7.69E-03	1.03E-02	2.50E-02	6.38E-02	3.91E-02	3.11E-02	5.80E-02	6.63E-02	4.95E-02	9.84E-02	3.54E-02	3.39E-03			

Table A23. Predicted disposal loading rates from commercial PV modules on Kauai'i.

		Panels Commercial - Kauai																		
Component	unit	2025	2026	2027	2028	2029	2030	2031	2032	2033	2034	2035	2036	2037	2038	2039	2040			
Loading	MWac	0	0	0	0	0	0	4.02	2.00	0.921	2	1.48	5.4	1.8	0.48	0.33	0.59			
PV material	kg	0.00E+00	0.00E+00	0.00E+00	0.00E+00	0.00E+00	0.00E+00	3.77E+05	1.87E+05	8.63E+04	1.87E+05	1.39E+05	5.06E+05	1.69E+05	4.50E+04	3.09E+04	5.53E+04			
Panels	#	0.00E+00	0.00E+00	0.00E+00	0.00E+00	0.00E+00	0.00E+00	1.75E+04	8.71E+03	4.01E+03	8.71E+03	6.45E+03	2.35E+04	7.84E+03	2.09E+03	1.44E+03	2.57E+03			
Glass	kg	0.00E+00	0.00E+00	0.00E+00	0.00E+00	0.00E+00	0.00E+00	2.58E+05	1.28E+05	5.91E+04	1.28E+05	9.49E+04	3.46E+05	1.15E+05	3.08E+04	2.12E+04	3.78E+04			
Aluminum	kg	0.00E+00	0.00E+00	0.00E+00	0.00E+00	0.00E+00	0.00E+00	6.56E+04	3.26E+04	1.50E+04	3.26E+04	2.41E+04	8.81E+04	2.94E+04	7.83E+03	5.38E+03	9.62E+03			
EVA	kg	0.00E+00	0.00E+00	0.00E+00	0.00E+00	0.00E+00	0.00E+00	2.17E+04	1.08E+04	4.98E+03	1.08E+04	8.00E+03	2.92E+04	9.74E+03	2.60E+03	1.78E+03	3.19E+03			
Si	kg	0.00E+00	0.00E+00	0.00E+00	0.00E+00	0.00E+00	0.00E+00	1.09E+04	5.44E+03	2.51E+03	5.45E+03	4.03E+03	1.47E+04	4.90E+03	1.31E+03	8.99E+02	1.61E+03			
PVF/PET	kg	0.00E+00	0.00E+00	0.00E+00	0.00E+00	0.00E+00	0.00E+00	6.38E+03	3.17E+03	1.46E+03	3.17E+03	2.35E+03	8.57E+03	2.86E+03	7.62E+02	5.24E+02	9.36E+02			
Cu	kg	0.00E+00	0.00E+00	0.00E+00	0.00E+00	0.00E+00	0.00E+00	2.55E+03	1.27E+03	5.84E+02	1.27E+03	9.39E+02	3.43E+03	1.14E+03	3.04E+02	2.09E+02	3.74E+02			
Mg	kg	0.00E+00	0.00E+00	0.00E+00	0.00E+00	0.00E+00	0.00E+00	2.14E+03	1.07E+03	4.91E+02	1.07E+03	7.89E+02	2.88E+03	9.59E+02	2.56E+02	1.76E+02	3.14E+02			
Pb	kg	0.00E+00	0.00E+00	0.00E+00	0.00E+00	0.00E+00	0.00E+00	1.84E+02	9.14E+01	4.21E+01	9.14E+01	6.76E+01	2.47E+02	8.23E+01	2.19E+01	1.51E+01	2.70E+01			
Su	kg	0.00E+00	0.00E+00	0.00E+00	0.00E+00	0.00E+00	0.00E+00	1.73E+02	8.60E+01	3.96E+01	8.60E+01	6.37E+01	2.32E+02	7.74E+01	2.06E+01	1.42E+01	2.54E+01			
Ag	kg	0.00E+00	0.00E+00	0.00E+00	0.00E+00	0.00E+00	0.00E+00	7.94E+02	3.95E+02	1.82E+02	3.95E+02	2.92E+02	1.07E+03	3.55E+02	9.48E+01	6.52E+01	1.17E+02			
Ni	kg	0.00E+00	0.00E+00	0.00E+00	0.00E+00	0.00E+00	0.00E+00	3.54E+00	1.76E+00	8.10E-01	1.76E+00	1.30E+00	4.75E+00	1.58E+00	4.22E-01	2.90E-01	5.19E-01			
Zn	kg	0.00E+00	0.00E+00	0.00E+00	0.00E+00	0.00E+00	0.00E+00	3.68E-02	1.83E-02	8.44E-03	1.83E-02	1.36E-02	4.95E-02	1.65E-02	4.40E-03	3.02E-03	5.40E-03			

Table A24. Predicted disposal loading rates from utility PV modules on O'ahu.

Utility PV Panel Disposal - Oahu																	
Component	unit	2025	2026	2027	2028	2029	2030	2031	2032	2033	2034	2035	2036	2037	2038	2039	2040
Loading	MWac	0	0	0	0	0	0	0	7	0	5	11	6.5	33	0	129.6	5.6
PV material	kg	0.00E+00	0.00E+00	0.00E+00	0.00E+00	0.00E+00	0.00E+00	0.00E+00	6.56E+05	0.00E+00	4.69E+05	1.03E+06	6.09E+05	3.09E+06	0.00E+00	1.21E+07	5.25E+05
Panels	#	0.00E+00	0.00E+00	0.00E+00	0.00E+00	0.00E+00	0.00E+00	0.00E+00	3.05E+04	0.00E+00	2.18E+04	4.79E+04	2.83E+04	1.44E+05	0.00E+00	5.65E+05	2.44E+04
Glass	kg	0.00E+00	0.00E+00	0.00E+00	0.00E+00	0.00E+00	0.00E+00	0.00E+00	4.49E+05	0.00E+00	3.21E+05	7.06E+05	4.17E+05	2.12E+06	0.00E+00	8.31E+06	3.59E+05
Aluminum	kg	0.00E+00	0.00E+00	0.00E+00	0.00E+00	0.00E+00	0.00E+00	0.00E+00	1.14E+05	0.00E+00	8.15E+04	1.79E+05	1.06E+05	5.38E+05	0.00E+00	2.11E+06	9.13E+04
EVA	kg	0.00E+00	0.00E+00	0.00E+00	0.00E+00	0.00E+00	0.00E+00	0.00E+00	3.79E+04	0.00E+00	2.70E+04	5.98E+04	3.52E+04	1.78E+05	0.00E+00	7.01E+05	3.03E+04
Si	kg	0.00E+00	0.00E+00	0.00E+00	0.00E+00	0.00E+00	0.00E+00	0.00E+00	1.91E+04	0.00E+00	1.36E+04	3.00E+04	1.77E+04	8.99E+04	0.00E+00	3.53E+05	1.53E+04
PVF/PET	kg	0.00E+00	0.00E+00	0.00E+00	0.00E+00	0.00E+00	0.00E+00	0.00E+00	1.11E+04	0.00E+00	7.94E+03	1.75E+04	1.03E+04	5.24E+04	0.00E+00	2.06E+05	8.89E+03
Cu	kg	0.00E+00	0.00E+00	0.00E+00	0.00E+00	0.00E+00	0.00E+00	0.00E+00	4.44E+03	0.00E+00	3.17E+03	6.98E+03	4.12E+03	2.09E+04	0.00E+00	8.22E+04	3.55E+03
Mg	kg	0.00E+00	0.00E+00	0.00E+00	0.00E+00	0.00E+00	0.00E+00	0.00E+00	3.73E+03	0.00E+00	2.66E+03	5.86E+03	3.46E+03	1.76E+04	0.00E+00	6.91E+04	2.98E+03
Pb	kg	0.00E+00	0.00E+00	0.00E+00	0.00E+00	0.00E+00	0.00E+00	0.00E+00	3.20E+02	0.00E+00	2.28E+02	5.03E+02	2.97E+02	1.51E+03	0.00E+00	5.92E+03	2.56E+02
Su	kg	0.00E+00	0.00E+00	0.00E+00	0.00E+00	0.00E+00	0.00E+00	0.00E+00	3.01E+02	0.00E+00	2.15E+02	4.73E+02	2.80E+02	1.42E+03	0.00E+00	5.57E+03	2.41E+02
Ag	kg	0.00E+00	0.00E+00	0.00E+00	0.00E+00	0.00E+00	0.00E+00	0.00E+00	1.38E+03	0.00E+00	9.87E+02	2.17E+03	1.28E+03	6.52E+03	0.00E+00	2.56E+04	1.11E+03
Ni	kg	0.00E+00	0.00E+00	0.00E+00	0.00E+00	0.00E+00	0.00E+00	0.00E+00	6.16E+00	0.00E+00	4.40E+00	9.68E+00	5.72E+00	2.90E+01	0.00E+00	1.14E+02	4.93E+00
Zn	kg	0.00E+00	0.00E+00	0.00E+00	0.00E+00	0.00E+00	0.00E+00	0.00E+00	6.41E-02	0.00E+00	4.58E-02	1.01E-01	5.95E-02	3.02E-01	0.00E+00	1.19E+00	5.13E-02

Table A25. Predicted disposal loading rates from utility PV modules in Hawai'i County.

Utility PV Panel Disposal - Hawaii																	
Component	unit	2025	2026	2027	2028	2029	2030	2031	2032	2033	2034	2035	2036	2037	2038	2039	2040
Loading	MWac	0	0	0	0	0	0	0	0	0	0	0	0	0	0	0	0
PV material	kg	0.00E+00	0.00E+00	0.00E+00	0.00E+00	0.00E+00	0.00E+00	0.00E+00	0.00E+00	0.00E+00	0.00E+00	0.00E+00	0.00E+00	0.00E+00	0.00E+00	0.00E+00	0.00E+00
Panels	#	0.00E+00	0.00E+00	0.00E+00	0.00E+00	0.00E+00	0.00E+00	0.00E+00	0.00E+00	0.00E+00	0.00E+00	0.00E+00	0.00E+00	0.00E+00	0.00E+00	0.00E+00	0.00E+00
Glass	kg	0.00E+00	0.00E+00	0.00E+00	0.00E+00	0.00E+00	0.00E+00	0.00E+00	0.00E+00	0.00E+00	0.00E+00	0.00E+00	0.00E+00	0.00E+00	0.00E+00	0.00E+00	0.00E+00
Aluminum	kg	0.00E+00	0.00E+00	0.00E+00	0.00E+00	0.00E+00	0.00E+00	0.00E+00	0.00E+00	0.00E+00	0.00E+00	0.00E+00	0.00E+00	0.00E+00	0.00E+00	0.00E+00	0.00E+00
EVA	kg	0.00E+00	0.00E+00	0.00E+00	0.00E+00	0.00E+00	0.00E+00	0.00E+00	0.00E+00	0.00E+00	0.00E+00	0.00E+00	0.00E+00	0.00E+00	0.00E+00	0.00E+00	0.00E+00
Si	kg	0.00E+00	0.00E+00	0.00E+00	0.00E+00	0.00E+00	0.00E+00	0.00E+00	0.00E+00	0.00E+00	0.00E+00	0.00E+00	0.00E+00	0.00E+00	0.00E+00	0.00E+00	0.00E+00
PVF/PET	kg	0.00E+00	0.00E+00	0.00E+00	0.00E+00	0.00E+00	0.00E+00	0.00E+00	0.00E+00	0.00E+00	0.00E+00	0.00E+00	0.00E+00	0.00E+00	0.00E+00	0.00E+00	0.00E+00
Cu	kg	0.00E+00	0.00E+00	0.00E+00	0.00E+00	0.00E+00	0.00E+00	0.00E+00	0.00E+00	0.00E+00	0.00E+00	0.00E+00	0.00E+00	0.00E+00	0.00E+00	0.00E+00	0.00E+00
Mg	kg	0.00E+00	0.00E+00	0.00E+00	0.00E+00	0.00E+00	0.00E+00	0.00E+00	0.00E+00	0.00E+00	0.00E+00	0.00E+00	0.00E+00	0.00E+00	0.00E+00	0.00E+00	0.00E+00
Pb	kg	0.00E+00	0.00E+00	0.00E+00	0.00E+00	0.00E+00	0.00E+00	0.00E+00	0.00E+00	0.00E+00	0.00E+00	0.00E+00	0.00E+00	0.00E+00	0.00E+00	0.00E+00	0.00E+00
Sn	kg	0.00E+00	0.00E+00	0.00E+00	0.00E+00	0.00E+00	0.00E+00	0.00E+00	0.00E+00	0.00E+00	0.00E+00	0.00E+00	0.00E+00	0.00E+00	0.00E+00	0.00E+00	0.00E+00
Ag	kg	0.00E+00	0.00E+00	0.00E+00	0.00E+00	0.00E+00	0.00E+00	0.00E+00	0.00E+00	0.00E+00	0.00E+00	0.00E+00	0.00E+00	0.00E+00	0.00E+00	0.00E+00	0.00E+00
Ni	kg	0.00E+00	0.00E+00	0.00E+00	0.00E+00	0.00E+00	0.00E+00	0.00E+00	0.00E+00	0.00E+00	0.00E+00	0.00E+00	0.00E+00	0.00E+00	0.00E+00	0.00E+00	0.00E+00
Zn	kg	0.00E+00	0.00E+00	0.00E+00	0.00E+00	0.00E+00	0.00E+00	0.00E+00	0.00E+00	0.00E+00	0.00E+00	0.00E+00	0.00E+00	0.00E+00	0.00E+00	0.00E+00	0.00E+00

Table A26. Predicted disposal loading rates from utility PV modules on Maui.

		Utility PV Panel Disposal - Maui															
Component	unit	2025	2026	2027	2028	2029	2030	2031	2032	2033	2034	2035	2036	2037	2038	2039	2040
Loading	MWac	0	0	0	1.2	0	0	0	0	0	0	0	0	0	5.8	0	0
PV material	kg	0.00E+00	0.00E+00	0.00E+00	1.12E+05	0.00E+00	0.00E+00	0.00E+00	0.00E+00	0.00E+00	0.00E+00	0.00E+00	0.00E+00	0.00E+00	5.44E+05	0.00E+00	0.00E+00
Panels	#	0.00E+00	0.00E+00	0.00E+00	5.23E+03	0.00E+00	0.00E+00	0.00E+00	0.00E+00	0.00E+00	0.00E+00	0.00E+00	0.00E+00	0.00E+00	2.53E+04	0.00E+00	0.00E+00
Glass	kg	0.00E+00	0.00E+00	0.00E+00	7.70E+04	0.00E+00	0.00E+00	0.00E+00	0.00E+00	0.00E+00	0.00E+00	0.00E+00	0.00E+00	0.00E+00	3.72E+05	0.00E+00	0.00E+00
Aluminum	kg	0.00E+00	0.00E+00	0.00E+00	1.96E+04	0.00E+00	0.00E+00	0.00E+00	0.00E+00	0.00E+00	0.00E+00	0.00E+00	0.00E+00	0.00E+00	9.46E+04	0.00E+00	0.00E+00
EVA	kg	0.00E+00	0.00E+00	0.00E+00	6.49E+03	0.00E+00	0.00E+00	0.00E+00	0.00E+00	0.00E+00	0.00E+00	0.00E+00	0.00E+00	0.00E+00	3.14E+04	0.00E+00	0.00E+00
Si	kg	0.00E+00	0.00E+00	0.00E+00	3.27E+03	0.00E+00	0.00E+00	0.00E+00	0.00E+00	0.00E+00	0.00E+00	0.00E+00	0.00E+00	0.00E+00	1.58E+04	0.00E+00	0.00E+00
PVF/PET	kg	0.00E+00	0.00E+00	0.00E+00	1.90E+03	0.00E+00	0.00E+00	0.00E+00	0.00E+00	0.00E+00	0.00E+00	0.00E+00	0.00E+00	0.00E+00	9.20E+03	0.00E+00	0.00E+00
Cu	kg	0.00E+00	0.00E+00	0.00E+00	7.61E+02	0.00E+00	0.00E+00	0.00E+00	0.00E+00	0.00E+00	0.00E+00	0.00E+00	0.00E+00	0.00E+00	3.68E+03	0.00E+00	0.00E+00
Mg	kg	0.00E+00	0.00E+00	0.00E+00	6.40E+02	0.00E+00	0.00E+00	0.00E+00	0.00E+00	0.00E+00	0.00E+00	0.00E+00	0.00E+00	0.00E+00	3.09E+03	0.00E+00	0.00E+00
Pb	kg	0.00E+00	0.00E+00	0.00E+00	5.48E+01	0.00E+00	0.00E+00	0.00E+00	0.00E+00	0.00E+00	0.00E+00	0.00E+00	0.00E+00	0.00E+00	2.65E+02	0.00E+00	0.00E+00
Sn	kg	0.00E+00	0.00E+00	0.00E+00	5.16E+01	0.00E+00	0.00E+00	0.00E+00	0.00E+00	0.00E+00	0.00E+00	0.00E+00	0.00E+00	0.00E+00	2.49E+02	0.00E+00	0.00E+00
Ag	kg	0.00E+00	0.00E+00	0.00E+00	2.37E+02	0.00E+00	0.00E+00	0.00E+00	0.00E+00	0.00E+00	0.00E+00	0.00E+00	0.00E+00	0.00E+00	1.15E+03	0.00E+00	0.00E+00
Ni	kg	0.00E+00	0.00E+00	0.00E+00	1.06E+00	0.00E+00	0.00E+00	0.00E+00	0.00E+00	0.00E+00	0.00E+00	0.00E+00	0.00E+00	0.00E+00	5.10E+00	0.00E+00	0.00E+00
Zn	kg	0.00E+00	0.00E+00	0.00E+00	1.10E+02	0.00E+00	0.00E+00	0.00E+00	0.00E+00	0.00E+00	0.00E+00	0.00E+00	0.00E+00	0.00E+00	5.31E+02	0.00E+00	0.00E+00

Table A27. Predicted disposal loading rates from utility PV modules on Kaua'i.

		Utility PV Panel Disposal - Kauai															
Component	unit	2025	2026	2027	2028	2029	2030	2031	2032	2033	2034	2035	2036	2037	2038	2039	2040
Loading	MWac	0	0	0	0	0	1	0	6	0	12	12	0	15	20	14	0
PV material	kg	0.00E+00	0.00E+00	0.00E+00	0.00E+00	0.00E+00	9.37E+04	0.00E+00	5.62E+05	0.00E+00	1.12E+06	1.12E+06	0.00E+00	1.41E+06	1.87E+06	1.31E+06	0.00E+00
Panels	#	0.00E+00	0.00E+00	0.00E+00	0.00E+00	0.00E+00	4.36E+03	0.00E+00	2.61E+04	0.00E+00	5.23E+04	5.23E+04	0.00E+00	6.53E+04	8.71E+04	6.10E+04	0.00E+00
Glass	kg	0.00E+00	0.00E+00	0.00E+00	0.00E+00	0.00E+00	6.41E+04	0.00E+00	3.85E+05	0.00E+00	7.70E+05	7.70E+05	0.00E+00	9.62E+05	1.28E+06	8.98E+05	0.00E+00
Aluminum	kg	0.00E+00	0.00E+00	0.00E+00	0.00E+00	0.00E+00	1.63E+04	0.00E+00	9.78E+04	0.00E+00	1.96E+05	1.96E+05	0.00E+00	2.45E+05	3.26E+05	2.28E+05	0.00E+00
EVA	kg	0.00E+00	0.00E+00	0.00E+00	0.00E+00	0.00E+00	5.41E+03	0.00E+00	3.25E+04	0.00E+00	6.49E+04	6.49E+04	0.00E+00	8.11E+04	1.08E+05	7.57E+04	0.00E+00
Si	kg	0.00E+00	0.00E+00	0.00E+00	0.00E+00	0.00E+00	2.72E+03	0.00E+00	1.63E+04	0.00E+00	3.27E+04	3.27E+04	0.00E+00	4.09E+04	5.45E+04	3.81E+04	0.00E+00
PVF/PET	kg	0.00E+00	0.00E+00	0.00E+00	0.00E+00	0.00E+00	1.59E+03	0.00E+00	9.52E+03	0.00E+00	1.90E+04	1.90E+04	0.00E+00	2.38E+04	3.17E+04	2.22E+04	0.00E+00
Cu	kg	0.00E+00	0.00E+00	0.00E+00	0.00E+00	0.00E+00	6.34E+02	0.00E+00	3.81E+03	0.00E+00	7.61E+03	7.61E+03	0.00E+00	9.52E+03	1.27E+04	8.88E+03	0.00E+00
Mg	kg	0.00E+00	0.00E+00	0.00E+00	0.00E+00	0.00E+00	5.33E+02	0.00E+00	3.20E+03	0.00E+00	6.40E+03	6.40E+03	0.00E+00	7.99E+03	1.07E+04	7.46E+03	0.00E+00
Pb	kg	0.00E+00	0.00E+00	0.00E+00	0.00E+00	0.00E+00	4.57E+01	0.00E+00	2.74E+02	0.00E+00	5.48E+02	5.48E+02	0.00E+00	6.85E+02	9.14E+02	6.40E+02	0.00E+00
Sn	kg	0.00E+00	0.00E+00	0.00E+00	0.00E+00	0.00E+00	4.30E+01	0.00E+00	2.58E+02	0.00E+00	5.16E+02	5.16E+02	0.00E+00	6.45E+02	8.60E+02	6.02E+02	0.00E+00
Ag	kg	0.00E+00	0.00E+00	0.00E+00	0.00E+00	0.00E+00	1.97E+02	0.00E+00	1.18E+03	0.00E+00	2.37E+03	2.37E+03	0.00E+00	2.96E+03	3.95E+03	2.76E+03	0.00E+00
Ni	kg	0.00E+00	0.00E+00	0.00E+00	0.00E+00	0.00E+00	8.80E-01	0.00E+00	5.28E+00	0.00E+00	1.06E+01	1.06E+01	0.00E+00	1.32E+01	1.76E+01	1.23E+01	0.00E+00
Zn	kg	0.00E+00	0.00E+00	0.00E+00	0.00E+00	0.00E+00	9.16E-03	0.00E+00	5.50E-02	0.00E+00	1.10E-01	1.10E-01	0.00E+00	1.37E-01	1.83E-01	1.28E-01	0.00E+00

Table A28. Aggregate prediction of PV material disposal rates across all islands and scale.

Component	unit	2025	2026	2027	2028	2029	2030	2031	2032	2033	2034	2035	2036	2037	2038	2039	2040
PV material	kg	1.67E+05	5.57E+04	2.13E+05	7.90E+05	1.11E+06	1.58E+06	4.18E+06	1.03E+07	1.24E+07	1.04E+07	1.17E+07	1.06E+07	1.24E+07	7.38E+06	1.79E+07	6.90E+06
Panels	#	7.76E+03	2.59E+03	9.92E+03	3.67E+04	5.17E+04	7.34E+04	1.94E+05	4.77E+05	5.75E+05	4.82E+05	5.44E+05	4.94E+05	5.74E+05	3.43E+05	8.33E+05	3.21E+05
Glass	kg	1.14E+05	3.81E+04	1.46E+05	5.41E+05	7.62E+05	1.08E+06	2.86E+06	7.03E+06	8.47E+06	7.10E+06	8.02E+06	7.27E+06	8.46E+06	5.05E+06	1.23E+07	4.72E+06
Aluminum	kg	2.91E+04	9.69E+03	3.71E+04	1.37E+05	1.94E+05	2.75E+05	7.27E+05	1.79E+06	2.15E+06	1.80E+06	2.04E+06	1.85E+06	2.15E+06	1.28E+06	3.12E+06	1.20E+06
EVA	kg	9.64E+03	3.21E+03	1.23E+04	4.56E+04	6.43E+04	9.11E+04	2.41E+05	5.93E+05	7.14E+05	5.98E+05	6.76E+05	6.13E+05	7.13E+05	4.26E+05	1.03E+06	3.98E+05
Si	kg	4.62E+03	1.54E+03	5.90E+03	2.20E+04	3.08E+04	4.38E+04	1.16E+05	2.87E+05	3.44E+05	2.84E+05	3.20E+05	2.95E+05	3.51E+05	2.07E+05	5.13E+05	1.93E+05
PVF/PET	kg	2.83E+03	9.43E+02	3.61E+03	1.34E+04	1.89E+04	2.67E+04	7.07E+04	1.74E+05	2.10E+05	1.76E+05	1.98E+05	1.80E+05	2.09E+05	1.25E+05	3.04E+05	1.17E+05
Cu	kg	1.13E+03	3.77E+02	1.44E+03	5.35E+03	7.54E+03	1.07E+04	2.83E+04	6.95E+04	8.38E+04	7.02E+04	7.93E+04	7.19E+04	8.37E+04	4.99E+04	1.21E+05	4.67E+04
Mg	kg	9.50E+02	3.17E+02	1.21E+03	4.49E+03	6.33E+03	8.98E+03	2.38E+04	5.84E+04	7.04E+04	5.90E+04	6.66E+04	6.04E+04	7.03E+04	4.20E+04	1.02E+05	3.92E+04
Pb	kg	8.14E+01	2.71E+01	1.04E+02	3.85E+02	5.43E+02	7.70E+02	2.04E+03	5.01E+03	6.03E+03	5.06E+03	5.71E+03	5.18E+03	6.03E+03	3.60E+03	8.74E+03	3.36E+03
Sn	kg	7.66E+01	2.55E+01	9.79E+01	3.62E+02	5.11E+02	7.24E+02	1.92E+03	4.72E+03	5.68E+03	4.76E+03	5.38E+03	4.88E+03	5.67E+03	3.39E+03	8.23E+03	3.17E+03
Ag	kg	3.52E+02	1.17E+02	4.50E+02	1.66E+03	2.35E+03	3.33E+03	8.80E+03	2.16E+04	2.61E+04	2.18E+04	2.47E+04	2.24E+04	2.60E+04	1.55E+04	3.78E+04	1.45E+04
Ni	kg	1.57E+00	5.23E-01	2.00E+00	7.41E+00	1.05E+01	1.48E+01	4.21E+02	3.19E+02	6.49E+02	5.93E+02	7.71E+02	4.12E+02	4.27E+02	3.50E+02	3.60E+02	3.40E+02
Zn	kg	1.63E-02	5.44E-03	2.09E-02	7.72E-02	1.09E-01	1.54E-01	2.10E+00	1.99E+00	3.57E+00	3.21E+00	4.07E+00	2.42E+00	2.58E+00	1.97E+00	2.60E+00	1.89E+00

Table A29. Aggregate prediction of PV material disposal rates on O'ahu across all scale.

Component	unit	2025	2026	2027	2028	2029	2030	2031	2032	2033	2034	2035	2036	2037	2038	2039	2040
PV material	kg	1.16E+05	3.88E+04	1.49E+05	4.72E+05	7.76E+05	1.03E+06	2.52E+06	6.70E+06	9.56E+06	6.28E+06	6.65E+06	6.98E+06	8.97E+06	2.90E+06	1.51E+07	5.40E+06
Panels	#	5.41E+03	1.80E+03	6.91E+03	2.19E+04	3.61E+04	4.81E+04	1.17E+05	3.11E+05	4.44E+05	2.92E+05	3.09E+05	3.25E+05	4.17E+05	1.35E+05	7.01E+05	2.51E+05
Glass	kg	7.97E+04	2.66E+04	1.02E+05	3.23E+05	5.31E+05	7.08E+05	1.73E+06	4.59E+06	6.54E+06	4.30E+06	4.55E+06	4.78E+06	6.14E+06	1.99E+06	1.03E+07	3.69E+06
Aluminum	kg	2.03E+04	6.75E+03	2.59E+04	8.21E+04	1.35E+05	1.80E+05	4.39E+05	1.17E+06	1.66E+06	1.09E+06	1.16E+06	1.21E+06	1.56E+06	5.06E+05	2.63E+06	9.39E+05
EVA	kg	6.72E+03	2.24E+03	8.58E+03	2.72E+04	4.48E+04	5.97E+04	1.46E+05	3.87E+05	5.52E+05	3.62E+05	3.84E+05	4.03E+05	5.18E+05	1.68E+05	8.71E+05	3.12E+05
Si	kg	3.38E+03	1.13E+03	4.32E+03	1.37E+04	2.26E+04	3.01E+04	7.33E+04	1.95E+05	2.78E+05	1.82E+05	1.93E+05	2.03E+05	2.61E+05	8.44E+04	4.39E+05	1.57E+05
PVF/PET	kg	1.97E+03	6.57E+02	2.52E+03	7.99E+03	1.31E+04	1.75E+04	4.27E+04	1.13E+05	1.62E+05	1.06E+05	1.13E+05	1.18E+05	1.52E+05	4.92E+04	2.56E+05	9.14E+04
Cu	kg	7.88E+02	2.63E+02	1.01E+03	3.20E+03	5.25E+03	7.00E+03	1.71E+04	4.53E+04	6.47E+04	4.25E+04	4.50E+04	4.73E+04	6.07E+04	1.97E+04	1.02E+05	3.65E+04
Mg	kg	6.62E+02	2.21E+02	8.46E+02	2.68E+03	4.41E+03	5.88E+03	1.43E+04	3.81E+04	5.44E+04	3.57E+04	3.78E+04	3.97E+04	5.10E+04	1.65E+04	8.58E+04	3.07E+04
Pb	kg	5.68E+01	1.89E+01	7.25E+01	3.78E+02	5.05E+02	1.23E+03	3.27E+03	4.66E+03	5.37E+03	3.06E+03	3.24E+03	3.40E+03	4.37E+03	1.42E+03	7.36E+03	2.63E+03
Sn	kg	5.34E+01	1.78E+01	6.83E+01	2.17E+02	3.56E+02	4.75E+02	1.16E+03	3.07E+03	4.39E+03	2.88E+03	3.05E+03	3.20E+03	4.12E+03	1.33E+03	6.93E+03	2.48E+03
Ag	kg	2.45E+02	8.18E+01	3.13E+02	9.95E+02	1.64E+03	2.18E+03	5.31E+03	1.41E+04	2.01E+04	1.32E+04	1.40E+04	1.47E+04	1.89E+04	6.12E+03	3.18E+04	1.14E+04
Ni	kg	1.09E+00	3.64E-01	1.40E+00	4.43E+00	7.28E+00	9.71E+00	2.37E+01	6.29E+01	8.97E+01	5.89E+01	6.25E+01	6.55E+01	8.42E+01	2.73E+01	1.42E+02	5.07E+01
Zn	kg	1.14E-02	3.79E-03	1.45E-02	4.61E-02	7.58E-02	1.01E-01	2.46E-01	6.55E-01	9.34E-01	6.14E-01	6.50E-01	6.82E-01	8.77E-01	2.84E-01	1.47E+00	5.28E-01

Table A30. Aggregate prediction of PV material disposal rates in Hawai'i County across all scale.

Component	unit	2025	2026	2027	2028	2029	2030	2031	2032	2033	2034	2035	2036	2037	2038	2039	2040
PV material	kg	2.36E+04	7.87E+03	3.02E+04	9.58E+04	1.57E+05	2.10E+05	5.12E+05	1.24E+06	1.30E+06	1.27E+06	1.70E+06	1.10E+06	7.97E+05	6.56E+05	5.62E+05	6.56E+05
Panels	#	1.10E+03	3.66E+02	1.40E+03	4.45E+03	7.32E+03	9.76E+03	2.38E+04	5.77E+04	6.05E+04	5.88E+04	7.88E+04	5.10E+04	3.70E+04	3.05E+04	2.61E+04	3.05E+04
Glass	kg	1.62E+04	5.39E+03	2.07E+04	6.56E+04	1.08E+05	1.44E+05	3.50E+05	8.49E+05	8.92E+05	8.66E+05	1.16E+06	7.50E+05	5.45E+05	4.49E+05	3.85E+05	4.49E+05
Aluminum	kg	4.11E+03	1.37E+03	5.25E+03	1.67E+04	2.74E+04	3.65E+04	8.90E+04	2.16E+05	2.27E+05	2.20E+05	2.95E+05	1.91E+05	1.39E+05	1.14E+05	9.78E+04	1.14E+05
EVA	kg	1.36E+03	4.54E+02	1.74E+03	5.53E+03	9.09E+03	1.21E+04	2.95E+04	7.16E+04	7.52E+04	7.30E+04	9.79E+04	6.33E+04	4.60E+04	3.79E+04	3.25E+04	3.79E+04
Si	kg	4.49E+02	1.50E+02	5.73E+02	1.82E+03	2.99E+03	3.99E+03	9.72E+03	2.44E+04	2.27E+04	1.93E+04	2.90E+04	1.80E+04	1.54E+04	1.16E+04	8.20E+03	1.14E+04
PVF/PET	kg	4.00E+02	1.33E+02	5.11E+02	1.62E+03	2.67E+03	3.55E+03	8.67E+03	2.10E+04	2.21E+04	2.14E+04	2.87E+04	1.86E+04	1.35E+04	1.11E+04	9.52E+03	1.11E+04
Cu	kg	1.60E+02	5.33E+01	2.04E+02	6.48E+02	1.07E+03	1.42E+03	3.46E+03	8.40E+03	8.82E+03	8.56E+03	1.15E+04	7.42E+03	5.39E+03	4.44E+03	3.81E+03	4.44E+03
Mg	kg	1.34E+02	4.48E+01	1.72E+02	5.45E+02	8.95E+02	1.19E+03	2.91E+03	7.06E+03	7.41E+03	7.20E+03	9.65E+03	6.24E+03	4.53E+03	3.73E+03	3.20E+03	3.73E+03
Pb	kg	1.15E+01	3.84E+00	1.47E+01	4.67E+01	7.68E+01	1.02E+02	2.50E+02	6.05E+02	6.35E+02	6.17E+02	8.27E+02	5.35E+02	3.88E+02	3.20E+02	2.74E+02	3.20E+02
Sn	kg	1.08E+01	3.61E+00	1.39E+01	4.40E+01	7.23E+01	9.63E+01	2.35E+02	5.69E+02	5.98E+02	5.81E+02	7.79E+02	5.03E+02	3.66E+02	3.01E+02	2.58E+02	3.01E+02
Ag	kg	4.98E+01	1.66E+01	6.36E+01	2.02E+02	3.32E+02	4.42E+02	1.08E+03	2.61E+03	2.75E+03	2.67E+03	3.57E+03	2.31E+03	1.68E+03	1.38E+03	1.18E+03	1.38E+03
Ni	kg	2.22E+01	7.39E+02	2.83E+01	8.99E+01	1.48E+00	1.97E+00	4.80E+00	1.16E+01	1.22E+01	1.19E+01	1.59E+01	1.03E+01	7.48E+00	6.16E+00	5.28E+00	6.16E+00
Zn	kg	2.31E+03	7.69E+04	2.95E+03	9.36E+03	1.54E+02	2.03E+02	5.00E+02	1.21E+01	1.27E+01	1.24E+01	1.66E+01	1.07E+01	7.79E+02	6.41E+02	5.50E+02	6.41E+02

Table A31. Aggregate prediction of PV material disposal rates on Maui across all scale.

Component	unit	2025	2026	2027	2028	2029	2030	2031	2032	2033	2034	2035	2036	2037	2038	2039	2040
PV material	kg	2.70E+04	9.00E+03	3.45E+04	2.22E+05	1.80E+05	2.40E+05	5.85E+05	1.48E+06	1.17E+06	1.27E+06	1.78E+06	1.89E+06	8.71E+05	1.76E+06	8.43E+05	6.56E+05
Panels	#	1.25E+03	4.18E+02	1.60E+03	1.03E+04	8.36E+03	1.12E+04	2.72E+04	6.86E+04	5.44E+04	5.92E+04	8.29E+04	8.78E+04	4.05E+04	8.19E+04	3.92E+04	3.05E+04
Glass	kg	1.85E+04	6.16E+03	2.36E+04	1.52E+05	1.23E+05	1.64E+05	4.00E+05	1.01E+06	8.02E+05	8.72E+05	1.22E+06	1.29E+06	5.97E+05	1.21E+06	5.77E+05	4.49E+05
Aluminum	kg	4.70E+03	1.57E+03	6.00E+03	3.86E+04	3.13E+04	4.17E+04	1.02E+05	2.57E+05	2.04E+05	2.22E+05	3.10E+05	3.29E+05	1.52E+05	3.07E+05	1.47E+05	1.14E+05
EVA	kg	1.56E+03	5.19E+02	1.99E+03	1.28E+04	1.04E+04	1.38E+04	3.37E+04	8.52E+04	6.76E+04	7.36E+04	1.03E+05	1.09E+05	5.03E+04	1.02E+05	4.87E+04	3.79E+04
Si	kg	7.84E+02	2.61E+02	1.00E+03	6.45E+03	5.23E+03	6.97E+03	1.70E+04	4.29E+04	3.40E+04	3.70E+04	5.19E+04	5.49E+04	2.53E+04	5.12E+04	2.45E+04	1.91E+04
PVF/PET	kg	4.57E+02	1.52E+02	5.84E+02	3.76E+03	3.05E+03	4.06E+03	9.90E+03	2.50E+04	1.98E+04	2.16E+04	3.02E+04	3.20E+04	1.48E+04	2.98E+04	1.43E+04	1.11E+04
Cu	kg	1.83E+02	6.09E+01	2.33E+02	1.50E+03	1.22E+03	1.62E+03	3.96E+03	1.00E+04	7.93E+03	8.63E+03	1.21E+04	1.28E+04	5.90E+03	1.19E+04	5.71E+03	4.44E+03
Mg	kg	1.54E+02	5.12E+01	1.96E+02	1.26E+03	1.02E+03	1.36E+03	3.33E+03	8.40E+03	6.66E+03	7.25E+03	1.01E+04	1.07E+04	4.96E+03	1.00E+04	4.80E+03	3.73E+03
Pb	kg	1.32E+01	4.39E+00	1.68E+01	1.08E+02	8.77E+01	1.17E+02	2.85E+02	7.20E+02	5.71E+02	6.22E+02	8.70E+02	9.21E+02	4.25E+02	8.59E+02	4.11E+02	3.20E+02
Sn	kg	1.24E+01	4.13E+00	1.58E+01	1.02E+02	8.26E+01	1.10E+02	2.68E+02	6.78E+02	5.38E+02	5.83E+02	8.19E+02	8.67E+02	4.00E+02	8.09E+02	3.87E+02	3.01E+02
Ag	kg	5.69E+01	1.90E+01	7.27E+01	4.68E+02	3.79E+02	5.06E+02	1.23E+03	3.11E+03	2.47E+03	2.69E+03	3.76E+03	3.98E+03	1.84E+03	3.71E+03	1.78E+03	1.38E+03
Ni	kg	2.53E+01	8.44E+02	3.24E+01	2.08E+00	1.69E+00	2.25E+00	5.49E+00	1.39E+01	1.10E+01	1.20E+01	1.67E+01	1.77E+01	8.18E+00	1.65E+01	7.92E+00	6.16E+00
Zn	kg	2.64E+03	8.79E+04	3.37E+03	2.17E+02	1.76E+02	2.34E+02	5.72E+02	1.44E+01	1.15E+01	1.25E+01	1.74E+01	1.85E+01	8.52E+02	1.72E+01	8.24E+02	6.41E+02

Table A32. Aggregate prediction of PV material disposal rates on Kaua'i across all scale.

Component	unit	2025	2026	2027	2028	2029	2030	2031	2032	2033	2034	2035	2036	2037	2038	2039	2040
PV material	kg	0.00E+00	0.00E+00	0.00E+00	0.00E+00	0.00E+00	9.37E+04	5.58E+05	8.56E+05	3.40E+05	1.55E+06	1.58E+06	6.55E+05	1.72E+06	2.05E+06	1.43E+06	1.86E+05
Panels	#	0.00E+00	0.00E+00	0.00E+00	0.00E+00	0.00E+00	4.36E+03	2.60E+04	3.98E+04	1.58E+04	7.20E+04	7.34E+04	3.04E+04	8.01E+04	9.54E+04	6.67E+04	8.67E+03
Glass	kg	0.00E+00	0.00E+00	0.00E+00	0.00E+00	0.00E+00	6.41E+04	3.82E+05	5.86E+05	2.33E+05	1.06E+06	1.08E+06	4.48E+05	1.18E+06	1.41E+06	9.82E+05	1.28E+05
Aluminium	kg	0.00E+00	0.00E+00	0.00E+00	0.00E+00	0.00E+00	1.63E+04	9.72E+04	1.49E+05	5.92E+04	2.69E+05	2.75E+05	1.14E+05	3.00E+05	3.57E+05	2.50E+05	3.25E+04
EVA	kg	0.00E+00	0.00E+00	0.00E+00	0.00E+00	0.00E+00	5.41E+03	3.22E+04	4.94E+04	1.96E+04	8.93E+04	9.11E+04	3.78E+04	9.94E+04	1.19E+05	8.28E+04	1.08E+04
Si	kg	0.00E+00	0.00E+00	0.00E+00	0.00E+00	0.00E+00	2.72E+03	1.62E+04	2.49E+04	9.89E+03	4.50E+04	4.59E+04	1.90E+04	5.01E+04	5.97E+04	4.17E+04	5.42E+03
PVF/PET	kg	0.00E+00	0.00E+00	0.00E+00	0.00E+00	0.00E+00	1.59E+03	9.46E+03	1.45E+04	5.76E+03	2.62E+04	2.67E+04	1.11E+04	2.92E+04	3.48E+04	2.43E+04	3.16E+03
Cu	kg	0.00E+00	0.00E+00	0.00E+00	0.00E+00	0.00E+00	6.34E+02	3.78E+03	5.79E+03	2.30E+03	1.05E+04	1.07E+04	4.43E+03	1.17E+04	1.39E+04	9.71E+03	1.26E+03
Mg	kg	0.00E+00	0.00E+00	0.00E+00	0.00E+00	0.00E+00	5.33E+02	3.18E+03	4.87E+03	1.93E+03	8.81E+03	8.98E+03	3.73E+03	9.80E+03	1.17E+04	8.16E+03	1.06E+03
Pb	kg	0.00E+00	0.00E+00	0.00E+00	0.00E+00	0.00E+00	4.57E+01	2.72E+02	4.17E+02	1.66E+02	7.55E+02	7.70E+02	3.19E+02	8.40E+02	1.00E+03	6.99E+02	9.09E+01
Sn	kg	0.00E+00	0.00E+00	0.00E+00	0.00E+00	0.00E+00	4.30E+01	2.56E+02	3.93E+02	1.56E+02	7.11E+02	7.24E+02	3.01E+02	7.91E+02	9.42E+02	6.58E+02	8.56E+01
Ag	kg	0.00E+00	0.00E+00	0.00E+00	0.00E+00	0.00E+00	1.97E+02	1.18E+03	1.80E+03	7.17E+02	3.26E+03	3.33E+03	1.38E+03	3.63E+03	4.33E+03	3.02E+03	3.93E+02
Ni	kg	0.00E+00	0.00E+00	0.00E+00	0.00E+00	0.00E+00	8.80E-01	3.87E+02	2.30E+02	5.36E+02	5.10E+02	6.75E+02	3.19E+02	3.27E+02	3.00E+02	2.05E+02	2.77E+02
Zn	kg	0.00E+00	0.00E+00	0.00E+00	0.00E+00	0.00E+00	9.16E-03	1.74E+00	1.07E+00	2.39E+00	2.35E+00	3.08E+00	1.45E+00	1.54E+00	1.45E+00	9.90E-01	1.24E+00

Table A33. Predicted disposal rates from PV mounting structure across all scale on each island.

		Mounting Structure All Scale - Oahu															
Component	unit	2025	2026	2027	2028	2029	2030	2031	2032	2033	2034	2035	2036	2037	2038	2039	2040
Steel	kg	8.04E+03	2.68E+03	1.03E+04	3.26E+04	5.36E+04	7.15E+04	1.74E+05	7.80E+05	6.61E+05	6.61E+05	9.59E+05	7.77E+05	2.12E+06	2.01E+05	6.92E+06	6.27E+05
Aluminum	Kg	2.15E+04	7.16E+03	2.75E+04	8.71E+04	1.43E+05	1.91E+05	4.66E+05	1.34E+06	1.76E+06	1.23E+06	1.39E+06	1.38E+06	2.13E+06	5.36E+05	4.64E+06	1.08E+06
		Mounting Structure All Scale - Hawaii															
Component	unit	2025	2026	2027	2028	2029	2030	2031	2032	2033	2034	2035	2036	2037	2038	2039	2040
Steel	kg	1.63E+03	5.44E+02	2.09E+03	6.62E+03	1.09E+04	1.45E+04	3.54E+04	8.57E+04	9.00E+04	8.74E+04	1.17E+05	7.58E+04	5.50E+04	4.53E+04	3.89E+04	4.53E+04
Aluminum	Kg	4.36E+03	1.45E+03	5.57E+03	1.77E+04	2.91E+04	3.88E+04	9.45E+04	2.29E+05	2.40E+05	2.34E+05	3.13E+05	2.02E+05	1.47E+05	1.21E+05	1.04E+05	1.21E+05
		Mounting Structure All Scale - Maui															
Component	unit	2025	2026	2027	2028	2029	2030	2031	2032	2033	2034	2035	2036	2037	2038	2039	2040
Steel	kg	1.87E+03	6.22E+02	2.38E+03	6.98E+04	1.24E+04	1.66E+04	4.04E+04	1.02E+05	8.10E+04	8.81E+04	1.23E+05	1.31E+05	6.02E+04	3.85E+05	5.83E+04	4.53E+04
Aluminum	Kg	4.98E+03	1.66E+03	6.37E+03	5.81E+04	3.32E+04	4.43E+04	1.08E+05	2.73E+05	2.16E+05	2.35E+05	3.29E+05	3.49E+05	1.61E+05	4.08E+05	1.56E+05	1.21E+05
		Mounting Structure All Scale - Kauai															
Component	unit	2025	2026	2027	2028	2029	2030	2031	2032	2033	2034	2035	2036	2037	2038	2039	2040
Steel	kg	0.00E+00	0.00E+00	0.00E+00	0.00E+00	0.00E+00	5.18E+04	3.86E+04	3.18E+05	2.35E+05	6.51E+05	6.53E+05	4.53E+04	7.99E+05	1.05E+06	7.34E+05	1.29E+04
Aluminum	Kg	0.00E+00	0.00E+00	0.00E+00	0.00E+00	0.00E+00	3.16E+04	1.03E+05	2.09E+05	6.28E+05	4.58E+05	4.63E+05	1.21E+05	5.33E+05	6.65E+05	4.65E+05	3.44E+04

Table A34. Predicted disposal rates from residential PV mounting structures on each island.

Mounting Structure Rooftop Residential - Oahu																	
Component	unit	2025	2026	2027	2028	2029	2030	2031	2032	2033	2034	2035	2036	2037	2038	2039	2040
Loading	MW_{ac}	0.74	0.25	0.94	2.99	4.92	6.56	15.99	37.82	73.44	40.30	32.14	34.62	20.37	16.74	15.48	30.66
Steel	kg	4.78E+03	1.59E+03	6.11E+03	1.94E+04	3.19E+04	4.25E+04	1.04E+05	2.45E+05	4.76E+05	2.61E+05	2.08E+05	2.24E+05	1.32E+05	1.08E+05	1.00E+05	1.99E+05
Aluminum	Kg	1.28E+04	4.26E+03	1.63E+04	5.18E+04	8.51E+04	1.13E+05	2.77E+05	6.54E+05	1.27E+06	6.97E+05	5.56E+05	5.99E+05	3.52E+05	2.90E+05	2.68E+05	5.30E+05
Mounting Structure Rooftop Residential - Hawaii																	
Component	unit	2025	2026	2027	2028	2029	2030	2031	2032	2033	2034	2035	2036	2037	2038	2039	2040
Loading	MW_{ac}	0.14	0.05	0.18	0.58	0.96	1.28	3.12	7.05	9.17	10.55	12.28	8.42	4.71	4.55	4.93	4.62
Steel	kg	9.33E+02	3.11E+02	1.19E+03	3.78E+03	6.22E+03	8.29E+03	2.02E+04	4.56E+04	5.94E+04	6.83E+04	7.95E+04	5.45E+04	3.05E+04	2.95E+04	3.19E+04	2.99E+04
Aluminum	Kg	2.49E+03	8.30E+02	3.18E+03	1.01E+04	1.66E+04	2.21E+04	5.40E+04	1.22E+05	1.59E+05	1.83E+05	2.12E+05	1.46E+05	8.15E+04	7.87E+04	8.53E+04	7.99E+04
Mounting Structure Rooftop Residential - Maui																	
Component	unit	2025	2026	2027	2028	2029	2030	2031	2032	2033	2034	2035	2036	2037	2038	2039	2040
Loading	MW_{ac}	0.16	0.05	0.21	0.66	1.08	1.44	3.51	8.79	8.23	10.20	12.71	12.93	3.89	2.26	5.13	6.63
Steel	kg	1.05E+03	3.50E+02	1.34E+03	4.25E+03	6.99E+03	9.33E+03	2.27E+04	5.70E+04	5.33E+04	6.61E+04	8.23E+04	8.37E+04	2.52E+04	1.46E+04	3.32E+04	4.29E+04
Aluminum	Kg	2.80E+03	9.34E+02	3.58E+03	1.14E+04	1.87E+04	2.49E+04	6.07E+04	1.52E+05	1.42E+05	1.77E+05	2.20E+05	2.24E+05	6.73E+04	3.91E+04	8.87E+04	1.15E+05
Mounting Structure Rooftop Residential - Kauai																	
Component	unit	2025	2026	2027	2028	2029	2030	2031	2032	2033	2034	2035	2036	2037	2038	2039	2040
Loading	MW_{ac}	0.00	0.00	0.00	0.00	0.00	0.00	1.94	1.13	2.71	2.52	3.36	1.59	1.58	1.43	0.98	1.40
Steel	kg	0.00E+00	0.00E+00	0.00E+00	0.00E+00	0.00E+00	0.00E+00	1.26E+04	7.32E+03	1.75E+04	1.63E+04	2.18E+04	1.03E+04	1.02E+04	9.26E+03	6.32E+03	9.07E+03
Aluminum	Kg	0.00E+00	0.00E+00	0.00E+00	0.00E+00	0.00E+00	0.00E+00	3.36E+04	1.96E+04	4.69E+04	4.36E+04	5.81E+04	2.75E+04	2.73E+04	2.47E+04	1.69E+04	2.42E+04

Table A35. Predicted disposal loading rates from commercial PV mounting structures.

		Mounting Structure Rooftop Commercial - Oahu															
Component	unit	2025	2026	2027	2028	2029	2030	2031	2032	2033	2034	2035	2036	2037	2038	2039	2040
Loading	MWac	0.50	0.17	0.64	2.04	3.36	4.48	10.92	26.67	28.56	21.70	27.86	33.38	42.33	14.26	15.92	21.34
Steel	kg	3.26E+03	1.09E+03	4.17E+03	1.32E+04	2.18E+04	2.90E+04	7.07E+04	1.73E+05	1.85E+05	1.41E+05	1.80E+05	2.16E+05	2.74E+05	9.24E+04	1.03E+05	1.38E+05
Aluminum	Kg	8.72E+03	2.91E+03	1.11E+04	3.54E+04	5.81E+04	7.75E+04	1.89E+05	4.61E+05	4.94E+05	3.75E+05	4.82E+05	5.77E+05	7.32E+05	2.47E+05	2.75E+05	3.69E+05
		Mounting Structure Rooftop Commercial - Hawaii															
Component	unit	2025	2026	2027	2028	2029	2030	2031	2032	2033	2034	2035	2036	2037	2038	2039	2040
Loading	MWac	0.11	0.04	0.14	0.44	0.72	0.96	2.34	6.20	4.73	2.95	5.82	3.28	3.79	2.45	1.07	2.38
Steel	kg	6.99E+02	2.33E+02	8.94E+02	2.84E+03	4.66E+03	6.22E+03	1.52E+04	4.01E+04	3.06E+04	1.91E+04	3.77E+04	2.12E+04	2.45E+04	1.59E+04	6.93E+03	1.54E+04
Aluminum	Kg	1.87E+03	6.23E+02	2.39E+03	7.58E+03	1.25E+04	1.66E+04	4.05E+04	1.07E+05	8.18E+04	5.10E+04	1.01E+05	5.67E+04	6.56E+04	4.24E+04	1.85E+04	4.12E+04
		Mounting Structure Rooftop Commercial - Maui															
Component	unit	2025	2026	2027	2028	2029	2030	2031	2032	2033	2034	2035	2036	2037	2038	2039	2040
Loading	MWac	0.13	0.04	0.16	0.51	0.84	1.12	2.73	6.97	4.27	3.40	6.33	7.24	5.41	10.74	3.87	0.37
Steel	kg	8.16E+02	2.72E+02	1.04E+03	3.31E+03	5.44E+03	7.25E+03	1.77E+04	4.51E+04	2.77E+04	2.20E+04	4.10E+04	4.69E+04	3.50E+04	6.96E+04	2.51E+04	2.40E+03
Aluminum	Kg	2.18E+03	7.27E+02	2.79E+03	8.84E+03	1.45E+04	1.94E+04	4.72E+04	1.21E+05	7.39E+04	5.87E+04	1.10E+05	1.25E+05	9.36E+04	1.86E+05	6.69E+04	6.40E+03
		Mounting Structure Rooftop Commercial - Kauai															
Component	unit	2025	2026	2027	2028	2029	2030	2031	2032	2033	2034	2035	2036	2037	2038	2039	2040
Loading	MWac	0.00	0.00	0.00	0.00	0.00	0.00	4.02	0.00	0.92	2.00	1.48	5.40	1.80	0.48	0.33	0.59
Steel	kg	0.00E+00	0.00E+00	0.00E+00	0.00E+00	0.00E+00	0.00E+00	2.60E+04	0.00E+00	5.96E+03	1.30E+04	9.59E+03	3.50E+04	1.17E+04	3.11E+03	2.14E+03	3.82E+03
Aluminum	Kg	0.00E+00	0.00E+00	0.00E+00	0.00E+00	0.00E+00	0.00E+00	6.95E+04	0.00E+00	1.59E+04	3.46E+04	2.56E+04	9.34E+04	3.11E+04	8.30E+03	5.71E+03	1.02E+04

Table A36. Predicted disposal loading rates from utility PV mounting structures.

		Ground Mounting Structure Utility - Oahu															
Component	unit	2025	2026	2027	2028	2029	2030	2031	2032	2033	2034	2035	2036	2037	2038	2039	2040
Loading	MWac	0.00	0.00	0.00	0.00	0.00	0.00	0.00	7.00	0.00	5.00	11.00	6.50	33.00	0.00	129.60	5.60
Steel	kg	0.00E+00	0.00E+00	0.00E+00	0.00E+00	0.00E+00	0.00E+00	0.00E+00	3.63E+05	0.00E+00	2.59E+05	5.70E+05	3.37E+05	1.71E+06	0.00E+00	6.72E+06	2.90E+05
Aluminum	Kg	0.00E+00	0.00E+00	0.00E+00	0.00E+00	0.00E+00	0.00E+00	0.00E+00	2.21E+05	0.00E+00	1.58E+05	3.48E+05	2.06E+05	1.04E+06	0.00E+00	4.10E+06	1.77E+05
Zinc	Kg	0.00E+00	0.00E+00	0.00E+00	0.00E+00	0.00E+00	0.00E+00	0.00E+00	1.47E+04	0.00E+00	1.05E+04	2.32E+04	1.37E+04	6.95E+04	0.00E+00	2.73E+05	1.18E+04
		Ground Mounting Structure Utility - Hawaii															
Component	unit	2025	2026	2027	2028	2029	2030	2031	2032	2033	2034	2035	2036	2037	2038	2039	2040
Loading	MWac	0.00	0.00	0.00	0.00	0.00	0.00	0.00	0.00	0.00	0.00	0.00	0.00	0.00	0.00	0.00	0.00
Steel	kg	0.00E+00	0.00E+00	0.00E+00	0.00E+00	0.00E+00	0.00E+00	0.00E+00	0.00E+00	0.00E+00	0.00E+00	0.00E+00	0.00E+00	0.00E+00	0.00E+00	0.00E+00	0.00E+00
Aluminum	Kg	0.00E+00	0.00E+00	0.00E+00	0.00E+00	0.00E+00	0.00E+00	0.00E+00	0.00E+00	0.00E+00	0.00E+00	0.00E+00	0.00E+00	0.00E+00	0.00E+00	0.00E+00	0.00E+00
Zinc	Kg	0.00E+00	0.00E+00	0.00E+00	0.00E+00	0.00E+00	0.00E+00	0.00E+00	0.00E+00	0.00E+00	0.00E+00	0.00E+00	0.00E+00	0.00E+00	0.00E+00	0.00E+00	0.00E+00
		Ground Mounting Structure Utility - Maui															
Component	unit	2025	2026	2027	2028	2029	2030	2031	2032	2033	2034	2035	2036	2037	2038	2039	2040
Loading	MWac	0.00	0.00	0.00	1.20	0.00	0.00	0.00	0.00	0.00	0.00	0.00	0.00	0.00	5.80	0.00	0.00
Steel	kg	0.00E+00	0.00E+00	0.00E+00	6.22E+04	0.00E+00	0.00E+00	0.00E+00	0.00E+00	0.00E+00	0.00E+00	0.00E+00	0.00E+00	0.00E+00	3.01E+05	0.00E+00	0.00E+00
Aluminum	Kg	0.00E+00	0.00E+00	0.00E+00	3.79E+04	0.00E+00	0.00E+00	0.00E+00	0.00E+00	0.00E+00	0.00E+00	0.00E+00	0.00E+00	0.00E+00	1.83E+05	0.00E+00	0.00E+00
Zinc	Kg	0.00E+00	0.00E+00	0.00E+00	2.53E+03	0.00E+00	0.00E+00	0.00E+00	0.00E+00	0.00E+00	0.00E+00	0.00E+00	0.00E+00	0.00E+00	1.22E+04	0.00E+00	0.00E+00
		Ground Mounting Structure Utility - Kauai															
Component	unit	2025	2026	2027	2028	2029	2030	2031	2032	2033	2034	2035	2036	2037	2038	2039	2040
Loading	MWac	0.00	0.00	0.00	0.00	0.00	1.00	0.00	6.00	0.00	12.00	12.00	0.00	15.00	20.00	14.00	0.00
Steel	kg	0.00E+00	0.00E+00	0.00E+00	0.00E+00	0.00E+00	5.18E+04	0.00E+00	3.11E+05	0.00E+00	6.22E+05	6.22E+05	0.00E+00	7.77E+05	1.04E+06	7.26E+05	0.00E+00
Aluminum	Kg	0.00E+00	0.00E+00	0.00E+00	0.00E+00	0.00E+00	3.16E+04	0.00E+00	1.90E+05	0.00E+00	3.79E+05	3.79E+05	0.00E+00	4.74E+05	6.32E+05	4.43E+05	0.00E+00
Zinc	Kg	0.00E+00	0.00E+00	0.00E+00	0.00E+00	0.00E+00	2.11E+03	0.00E+00	1.26E+04	0.00E+00	2.53E+04	2.53E+04	0.00E+00	3.16E+04	4.21E+04	2.95E+04	0.00E+00

Table A37. Predicted disposal rates from PV cabling across all scale for each island.

		Cabling All Scale - Oahu															
Component	unit	2025	2026	2027	2028	2029	2030	2031	2032	2033	2034	2035	2036	2037	2038	2039	2040
Copper	kg	1.24E+03	4.14E+02	1.59E+03	5.04E+03	8.29E+03	1.11E+04	2.69E+04	1.12E+05	1.02E+05	9.58E+04	1.34E+05	1.12E+05	2.85E+05	3.10E+04	9.05E+05	8.98E+04
		Cabling All Scale - Hawaii															
Component	unit	2025	2026	2027	2028	2029	2030	2031	2032	2033	2034	2035	2036	2037	2038	2039	2040
Copper	kg	2.52E+02	8.41E+01	3.22E+02	1.02E+03	1.68E+03	2.24E+03	5.47E+03	1.33E+04	1.39E+04	1.35E+04	1.81E+04	1.17E+04	8.51E+03	7.01E+03	6.01E+03	7.01E+03
		Cabling All Scale - Maui															
Component	unit	2025	2026	2027	2028	2029	2030	2031	2032	2033	2034	2035	2036	2037	2038	2039	2040
Copper	kg	2.88E+02	9.61E+01	3.68E+02	9.26E+03	1.92E+03	2.56E+03	6.25E+03	1.58E+04	1.25E+04	1.36E+04	1.91E+04	2.02E+04	9.31E+03	5.21E+04	9.01E+03	7.01E+03
		Cabling All Scale - Kauai															
Component	unit	2025	2026	2027	2028	2029	2030	2031	2032	2033	2034	2035	2036	2037	2038	2039	2040
Copper	kg	0.00E+00	0.00E+00	0.00E+00	0.00E+00	0.00E+00	6.74E+03	5.97E+03	4.16E+04	3.63E+03	8.54E+04	8.57E+04	7.00E+03	1.05E+05	1.37E+05	9.57E+04	1.99E+03

Table A38. Predicted disposal rates from residential PV cabling on each island.

		Cabling Rooftop Residential - Oahu															
Component	unit	2025	2026	2027	2028	2029	2030	2031	2032	2033	2034	2035	2036	2037	2038	2039	2040
Loading	MWac	0.74	0.25	0.94	2.99	4.92	6.56	15.99	37.82	73.44	40.30	32.14	34.62	20.37	16.74	15.48	30.66
Copper	kg	7.39E+02	2.46E+02	9.44E+02	3.00E+03	4.92E+03	6.57E+03	1.60E+04	3.79E+04	7.35E+04	4.03E+04	3.22E+04	3.47E+04	2.04E+04	1.68E+04	1.55E+04	3.07E+04
		Cabling Rooftop Residential - Hawaii															
Component	unit	2025	2026	2027	2028	2029	2030	2031	2032	2033	2034	2035	2036	2037	2038	2039	2040
Loading	MWac	0.14	0.05	0.18	0.58	0.96	1.28	3.12	7.05	9.17	10.55	12.28	8.42	4.71	4.55	4.93	4.62
Copper	kg	1.44E+02	4.80E+01	1.84E+02	5.85E+02	9.61E+02	1.28E+03	3.12E+03	7.05E+03	9.18E+03	1.06E+04	1.23E+04	8.43E+03	4.71E+03	4.55E+03	4.93E+03	4.62E+03
		Cabling Rooftop Residential - Maui															
Component	unit	2025	2026	2027	2028	2029	2030	2031	2032	2033	2034	2035	2036	2037	2038	2039	2040
Loading	MWac	0.16	0.05	0.21	0.66	1.08	1.44	3.51	8.79	8.23	10.20	12.71	12.93	3.89	2.26	5.13	6.63
Copper	kg	1.62E+02	5.41E+01	2.07E+02	6.58E+02	1.08E+03	1.44E+03	3.51E+03	8.80E+03	8.24E+03	1.02E+04	1.27E+04	1.29E+04	3.90E+03	2.26E+03	5.14E+03	6.64E+03
		Cabling Rooftop Residential - Kauai															
Component	unit	2025	2026	2027	2028	2029	2030	2031	2032	2033	2034	2035	2036	2037	2038	2039	2040
Loading	MWac	0.00	0.00	0.00	0.00	0.00	0.00	1.94	1.13	2.71	2.52	3.36	1.59	1.58	1.43	0.98	1.40
Copper	kg	0.00E+00	0.00E+00	0.00E+00	0.00E+00	0.00E+00	0.00E+00	1.94E+03	1.13E+03	2.71E+03	2.52E+03	3.36E+03	1.59E+03	1.58E+03	1.43E+03	9.77E+02	1.40E+03

Table A39. Predicted disposal rates from commercial PV cabling on each island.

		Cabling Rooftop Commercial - Oahu															
Component	unit	2025	2026	2027	2028	2029	2030	2031	2032	2033	2034	2035	2036	2037	2038	2039	2040
Loading	MW _{ac}	0.50	0.17	0.64	2.04	3.36	4.48	10.92	26.67	28.56	21.70	27.86	33.38	42.33	14.26	15.92	21.34
Copper	kg	5.05E+02	1.68E+02	6.45E+02	2.05E+03	3.36E+03	4.48E+03	1.09E+04	2.67E+04	2.86E+04	2.17E+04	2.79E+04	3.34E+04	4.24E+04	1.43E+04	1.59E+04	2.14E+04
		Cabling Rooftop Commercial - Hawaii															
Component	unit	2025	2026	2027	2028	2029	2030	2031	2032	2033	2034	2035	2036	2037	2038	2039	2040
Loading	MW _{ac}	0.11	0.04	0.14	0.44	0.72	0.96	2.34	6.20	4.73	2.95	5.82	3.28	3.79	2.45	1.07	2.38
Copper	kg	1.08E+02	3.60E+01	1.38E+02	4.38E+02	7.21E+02	9.61E+02	2.34E+03	6.20E+03	4.73E+03	2.95E+03	5.82E+03	3.28E+03	3.79E+03	2.45E+03	1.07E+03	2.38E+03
		Cabling Rooftop Commercial - Maui															
Component	unit	2025	2026	2027	2028	2029	2030	2031	2032	2033	2034	2035	2036	2037	2038	2039	2040
Loading	MW _{ac}	0.13	0.04	0.16	0.51	0.84	1.12	2.73	6.97	4.27	3.40	6.33	7.24	5.41	10.74	3.87	0.37
Copper	kg	1.26E+02	4.20E+01	1.61E+02	5.12E+02	8.41E+02	1.12E+03	2.73E+03	6.97E+03	4.28E+03	3.40E+03	6.34E+03	7.24E+03	5.41E+03	1.08E+04	3.87E+03	3.70E+02
		Cabling Rooftop Commercial - Kauai															
Component	unit	2025	2026	2027	2028	2029	2030	2031	2032	2033	2034	2035	2036	2037	2038	2039	2040
Loading	MW _{ac}	0.00	0.00	0.00	0.00	0.00	0.00	4.02	0.00	0.92	2.00	1.48	5.40	1.80	0.48	0.33	0.59
Copper	kg	0.00E+00	0.00E+00	0.00E+00	0.00E+00	0.00E+00	0.00E+00	4.02E+03	0.00E+00	9.22E+02	2.00E+03	1.48E+03	5.41E+03	1.80E+03	4.80E+02	3.30E+02	5.91E+02

Table A40. Predicted disposal rates from utility PV cabling on each island.

		Cabling Ground Mounted Utility - Oahu															
Component	unit	2025	2026	2027	2028	2029	2030	2031	2032	2033	2034	2035	2036	2037	2038	2039	2040
Loading	MWac	0.00	0.00	0.00	0.00	0.00	0.00	0.00	7.00	0.00	5.00	11.00	6.50	33.00	0.00	129.60	5.60
Copper	kg	0.00E+00	0.00E+00	0.00E+00	0.00E+00	0.00E+00	0.00E+00	0.00E+00	4.72E+04	0.00E+00	3.37E+04	7.42E+04	4.38E+04	2.22E+05	0.00E+00	8.74E+05	3.78E+04
		Cabling Ground Mounted Utility - Hawaii															
Component	unit	2025	2026	2027	2028	2029	2030	2031	2032	2033	2034	2035	2036	2037	2038	2039	2040
Loading	MWac	0.00	0.00	0.00	0.00	0.00	0.00	0.00	0.00	0.00	0.00	0.00	0.00	0.00	0.00	0.00	0.00
Copper	kg	0.00E+00	0.00E+00	0.00E+00	0.00E+00	0.00E+00	0.00E+00	0.00E+00	0.00E+00	0.00E+00	0.00E+00	0.00E+00	0.00E+00	0.00E+00	0.00E+00	0.00E+00	0.00E+00
		Cabling Ground Mounted Utility - Maui															
Component	unit	2025	2026	2027	2028	2029	2030	2031	2032	2033	2034	2035	2036	2037	2038	2039	2040
Loading	MWac	0.00	0.00	0.00	1.20	0.00	0.00	0.00	0.00	0.00	0.00	0.00	0.00	0.00	5.80	0.00	0.00
Copper	kg	0.00E+00	0.00E+00	0.00E+00	8.09E+03	0.00E+00	0.00E+00	0.00E+00	0.00E+00	0.00E+00	0.00E+00	0.00E+00	0.00E+00	0.00E+00	3.91E+04	0.00E+00	0.00E+00
		Cabling Ground Mounted Utility - Kauai															
Component	unit	2025	2026	2027	2028	2029	2030	2031	2032	2033	2034	2035	2036	2037	2038	2039	2040
Loading	MWac	0.00	0.00	0.00	0.00	0.00	1.00	0.00	6.00	0.00	12.00	12.00	0.00	15.00	20.00	14.00	0.00
Copper	kg	0.00E+00	0.00E+00	0.00E+00	0.00E+00	0.00E+00	6.74E+03	0.00E+00	4.05E+04	0.00E+00	8.09E+04	8.09E+04	0.00E+00	1.01E+05	1.35E+05	9.44E+04	0.00E+00

Table A41. Predicted disposal rates from PV inverters across all scale on each island.

		Micro Inverter All Scale - Oahu																
Component	unit	2025	2026	2027	2028	2029	2030	2031	2032	2033	2034	2035	2036	2037	2038	2039	2040	Totals
Inverter	#	1.77E+03	5.90E+02	2.26E+03	7.18E+03	1.18E+04	1.57E+04	3.84E+04	9.08E+04	1.76E+05	9.67E+04	7.71E+04	8.31E+04	4.89E+04	4.02E+04	3.72E+04	7.36E+04	8.02E+05
Copper	kg	4.43E+01	1.48E+01	5.66E+01	1.80E+00	2.95E+00	3.94E+00	9.59E+00	2.27E+01	4.41E+01	2.42E+01	1.93E+01	2.08E+01	1.22E+01	1.00E+01	9.29E+00	1.84E+01	2.00E+02
Steel	kg	4.91E+01	4.89E+01	4.92E+01	5.02E+01	5.11E+01	5.19E+01	5.64E+01	6.69E+01	8.40E+01	6.81E+01	6.42E+01	6.54E+01	5.85E+01	5.68E+01	5.62E+01	6.35E+01	9.40E+02
Aluminum	kg	1.51E+02	5.03E+01	1.93E+02	6.12E+02	1.01E+03	1.34E+03	3.27E+03	7.74E+03	1.50E+04	8.25E+03	6.58E+03	7.08E+03	4.17E+03	3.43E+03	3.17E+03	6.27E+03	6.83E+04
		String Inverter All Scale - Oahu																
Component	unit	2025	2026	2027	2028	2029	2030	2031	2032	2033	2034	2035	2036	2037	2038	2039	2040	Totals
Inverter	#	9.69E+01	3.23E+01	1.24E+02	3.93E+02	6.46E+02	8.61E+02	2.10E+03	5.00E+03	8.78E+03	5.06E+03	4.46E+03	4.94E+03	3.82E+03	2.31E+03	2.29E+03	4.04E+03	4.50E+04
Copper	kg	1.41E+03	4.70E+02	1.80E+03	5.72E+03	9.41E+03	1.25E+04	3.06E+04	8.24E+04	1.17E+05	7.74E+04	8.23E+04	8.52E+04	1.13E+05	3.50E+04	2.06E+05	6.64E+04	9.26E+05
Steel	kg	9.54E+02	3.18E+02	1.22E+03	3.87E+03	6.36E+03	8.48E+03	2.07E+04	6.99E+04	7.18E+04	6.02E+04	7.96E+04	7.39E+04	1.52E+05	2.47E+04	3.98E+05	5.62E+04	1.03E+06
Aluminum	kg	5.24E+03	1.75E+03	6.70E+03	2.13E+04	3.49E+04	4.66E+04	1.14E+05	2.77E+05	3.94E+05	2.54E+05	2.69E+05	3.07E+05	3.29E+05	1.36E+05	2.07E+05	2.23E+05	2.63E+06
		Micro Inverter All Scale - Hawaii																
Component	unit	2025	2026	2027	2028	2029	2030	2031	2032	2033	2034	2035	2036	2037	2038	2039	2040	Totals
Inverter	#	3.46E+02	1.15E+02	4.42E+02	1.40E+03	2.30E+03	3.07E+03	7.49E+03	1.69E+04	2.20E+04	2.53E+04	2.95E+04	2.02E+04	1.13E+04	1.09E+04	1.18E+04	1.11E+04	1.74E+05
Copper	kg	8.64E+02	2.88E+02	1.10E+01	3.50E+01	5.76E+01	7.68E+01	1.87E+00	4.23E+00	5.50E+00	6.33E+00	7.37E+00	5.05E+00	2.83E+00	2.73E+00	2.96E+00	2.77E+00	4.56E+01
Steel	kg	3.37E+00	1.12E+00	4.31E+00	1.37E+01	2.25E+01	3.00E+01	7.30E+01	1.65E+02	2.15E+02	2.47E+02	2.87E+02	1.97E+02	1.10E+02	1.06E+02	1.15E+02	1.08E+02	1.70E+03
Aluminum	kg	2.95E+01	9.82E+00	3.76E+01	1.19E+02	1.96E+02	2.62E+02	6.38E+02	1.44E+03	1.88E+03	2.16E+03	2.51E+03	1.72E+03	9.64E+02	9.31E+02	1.01E+03	9.45E+02	1.49E+04
		String Inverter All Scale - Hawaii																
Component	unit	2025	2026	2027	2028	2029	2030	2031	2032	2033	2034	2035	2036	2037	2038	2039	2040	Totals
Inverter	#	1.93E+01	6.43E+00	2.47E+01	7.83E+01	1.29E+02	1.72E+02	4.18E+02	9.80E+02	1.14E+03	1.22E+03	1.51E+03	1.01E+03	6.41E+02	5.71E+02	5.56E+02	5.76E+02	9.05E+03
Copper	kg	4.14E+02	8.16E+01	3.13E+02	9.93E+02	1.63E+03	2.18E+03	5.30E+03	1.40E+04	1.07E+04	6.69E+03	1.32E+04	7.44E+03	8.59E+03	5.55E+03	2.43E+03	5.40E+03	8.50E+04
Steel	kg	1.97E+02	6.53E+01	2.51E+02	7.97E+02	1.31E+03	1.75E+03	4.26E+03	1.06E+04	1.02E+04	9.07E+03	1.31E+04	8.23E+03	6.71E+03	5.18E+03	3.91E+03	5.14E+03	8.08E+04
Aluminum	kg	1.08E+03	3.60E+02	1.38E+03	4.38E+03	7.20E+03	9.60E+03	2.34E+04	5.82E+04	5.61E+04	4.98E+04	7.21E+04	4.52E+04	3.68E+04	2.84E+04	2.15E+04	2.82E+04	4.44E+05

Table A41 (cont.). Predicted disposal rates from PV inverters across all scale on each island.

Micro Inverter All Scale - Maui																		
Component	unit	2025	2026	2027	2028	2029	2030	2031	2032	2033	2034	2035	2036	2037	2038	2039	2040	Totals
Inverter	#	3.89E+02	1.30E+02	4.97E+02	1.58E+03	2.59E+03	3.46E+03	8.42E+03	2.11E+04	1.97E+04	2.45E+04	3.05E+04	3.10E+04	9.34E+03	5.42E+03	1.23E+04	1.59E+04	1.87E+05
Copper	kg	9.72E+02	3.24E+02	1.24E+01	3.94E+01	6.48E+01	8.64E+01	2.11E+00	5.28E+00	4.94E+00	6.12E+00	7.62E+00	7.76E+00	2.34E+00	1.36E+00	3.08E+00	3.98E+00	4.67E+01
Steel	kg	3.79E+00	1.26E+00	4.84E+00	1.54E+01	2.53E+01	3.37E+01	8.21E+01	2.06E+02	1.93E+02	2.39E+02	2.97E+02	3.03E+02	9.11E+01	5.29E+01	1.20E+02	1.55E+02	1.82E+03
Aluminum	kg	3.31E+01	1.10E+01	4.24E+01	1.34E+02	2.21E+02	2.95E+02	7.18E+02	1.80E+03	1.68E+03	2.09E+03	2.60E+03	2.65E+03	7.96E+02	4.62E+02	1.05E+03	1.36E+03	1.59E+04
String Inverter All Scale - Maui																		
Component	unit	2025	2026	2027	2028	2029	2030	2031	2032	2033	2034	2035	2036	2037	2038	2039	2040	Totals
Inverter	#	2.19E+01	7.30E+00	2.80E+01	8.92E+01	1.46E+02	1.95E+02	4.74E+02	1.19E+03	1.03E+03	1.20E+03	1.57E+03	1.63E+03	6.21E+02	6.67E+02	6.88E+02	7.04E+02	1.03E+04
Copper	kg	2.85E+02	9.52E+01	3.65E+02	1.16E+03	1.90E+03	2.54E+03	6.19E+03	1.58E+04	9.68E+03	7.70E+03	1.43E+04	1.64E+04	1.23E+04	2.43E+04	8.77E+03	8.42E+02	1.23E+05
Steel	kg	2.26E+02	7.53E+01	2.89E+02	4.37E+03	1.51E+03	2.01E+03	4.90E+03	1.24E+04	9.19E+03	9.35E+03	1.39E+04	1.50E+04	7.99E+03	2.95E+04	7.03E+03	4.10E+03	1.22E+05
Aluminum	kg	1.24E+03	4.14E+02	1.59E+03	5.64E+03	8.28E+03	1.10E+04	2.69E+04	6.81E+04	5.05E+04	5.14E+04	7.64E+04	8.24E+04	4.39E+04	7.33E+04	3.86E+04	2.25E+04	5.62E+05
Micro Inverter All Scale - Kauai																		
Component	unit	2025	2026	2027	2028	2029	2030	2031	2032	2033	2034	2035	2036	2037	2038	2039	2040	Totals
Inverter	#	0.00E+00	0.00E+00	0.00E+00	0.00E+00	0.00E+00	0.00E+00	4.66E+03	2.71E+03	6.50E+03	6.05E+03	8.06E+03	3.82E+03	3.79E+03	3.43E+03	2.34E+03	3.36E+03	4.47E+04
Copper	kg	0.00E+00	0.00E+00	0.00E+00	0.00E+00	0.00E+00	0.00E+00	1.16E+00	6.79E+01	1.63E+00	1.51E+00	2.02E+00	9.54E+01	9.48E+01	8.58E+01	5.86E+01	8.40E+01	1.12E+01
Steel	kg	0.00E+00	0.00E+00	0.00E+00	0.00E+00	0.00E+00	0.00E+00	4.54E+01	2.65E+01	6.34E+01	5.90E+01	7.86E+01	3.72E+01	3.70E+01	3.35E+01	2.28E+01	3.28E+01	4.56E+02
Aluminum	kg	0.00E+00	0.00E+00	0.00E+00	0.00E+00	0.00E+00	0.00E+00	3.97E+02	2.31E+02	5.54E+02	5.16E+02	6.87E+02	3.25E+02	3.23E+02	2.93E+02	2.00E+02	2.86E+02	3.81E+03
String Inverter All Scale - Kauai																		
Component	unit	2025	2026	2027	2028	2029	2030	2031	2032	2033	2034	2035	2036	2037	2038	2039	2040	Totals
Inverter	#	0.00E+00	0.00E+00	0.00E+00	0.00E+00	0.00E+00	3.50E+01	3.63E+02	1.20E+02	3.19E+02	3.46E+02	4.13E+02	3.81E+02	2.42E+02	1.75E+02	1.20E+02	1.69E+02	2.65E+03
Copper	kg	0.00E+00	0.00E+00	0.00E+00	0.00E+00	0.00E+00	2.88E+03	6.61E+03	1.86E+04	4.18E+03	3.96E+04	4.01E+04	7.68E+03	4.69E+04	5.97E+04	4.18E+04	2.28E+03	2.70E+05
Steel	kg	0.00E+00	0.00E+00	0.00E+00	0.00E+00	0.00E+00	2.88E+03	5.41E+03	1.79E+04	2.50E+03	3.81E+04	3.80E+04	6.69E+03	4.60E+04	5.88E+04	4.12E+04	1.42E+03	2.59E+05
Aluminum	kg	0.00E+00	0.00E+00	0.00E+00	0.00E+00	0.00E+00	5.08E+02	2.97E+04	6.52E+03	1.38E+04	2.56E+04	2.51E+04	3.68E+04	2.31E+04	1.74E+04	1.21E+04	7.78E+03	1.98E+05

Table A42. Aggregate metals disposal rates from ancillary components across all scale for each island.

		Aggregate Material from Ancillary Components All Scale - Oahu																			
Component	unit	2025	2026	2027	2028	2029	2030	2031	2032	2033	2034	2035	2036	2037	2038	2039	2040				
Copper	kg	2.65E+03	8.85E+02	3.39E+03	1.08E+04	1.77E+04	2.36E+04	5.75E+04	1.94E+05	2.19E+05	1.73E+05	2.16E+05	1.97E+05	3.98E+05	6.61E+04	1.11E+06	1.56E+05				
Steel	kg	9.05E+03	3.05E+03	1.15E+04	3.65E+04	6.00E+04	8.00E+04	1.95E+05	8.50E+05	7.32E+05	7.21E+05	1.04E+06	8.51E+05	2.27E+06	2.26E+05	7.32E+06	6.83E+05				
Aluminum	kg	2.69E+04	8.96E+03	3.43E+04	1.09E+05	1.79E+05	2.39E+05	5.82E+05	1.62E+06	2.17E+06	1.49E+06	1.66E+06	1.70E+06	2.46E+06	6.75E+05	4.85E+06	1.31E+06				
		Aggregate Material from Ancillary Components All Scale - Hawaii																			
Component	unit	2025	2026	2027	2028	2029	2030	2031	2032	2033	2034	2035	2036	2037	2038	2039	2040				
Copper	kg	6.67E+02	1.66E+02	6.35E+02	2.02E+03	3.31E+03	4.42E+03	1.08E+04	2.73E+04	2.46E+04	2.02E+04	3.13E+04	1.92E+04	1.77E+04	1.26E+04	8.44E+03	1.24E+04				
Steel	kg	1.83E+03	6.11E+02	2.34E+03	7.43E+03	1.22E+04	1.63E+04	3.97E+04	9.65E+04	1.00E+05	9.67E+04	1.31E+05	8.42E+04	6.19E+04	5.06E+04	4.29E+04	5.06E+04				
Aluminum	kg	5.47E+03	1.82E+03	6.99E+03	2.22E+04	3.65E+04	4.86E+04	1.18E+05	2.89E+05	2.98E+05	2.86E+05	3.88E+05	2.49E+05	1.85E+05	1.50E+05	1.26E+05	1.50E+05				
		Aggregate Material from Ancillary Components All Scale - Maui																			
Component	unit	2025	2026	2027	2028	2029	2030	2031	2032	2033	2034	2035	2036	2037	2038	2039	2040				
Copper	kg	5.74E+02	1.91E+02	7.33E+02	1.04E+04	3.83E+03	5.10E+03	1.24E+04	3.16E+04	2.22E+04	2.13E+04	3.34E+04	3.66E+04	2.16E+04	7.64E+04	1.78E+04	7.85E+03				
Steel	kg	2.10E+03	6.98E+02	2.68E+03	7.41E+04	1.40E+04	1.86E+04	4.54E+04	1.15E+05	9.03E+04	9.77E+04	1.37E+05	1.46E+05	6.83E+04	4.14E+05	6.54E+04	4.96E+04				
Aluminum	kg	6.26E+03	2.09E+03	7.99E+03	6.39E+04	4.17E+04	5.56E+04	1.36E+05	3.43E+05	2.68E+05	2.89E+05	4.08E+05	4.34E+05	2.06E+05	4.82E+05	1.95E+05	1.45E+05				
		Aggregate Material from Ancillary Components All Scale - Kauai																			
Component	unit	2025	2026	2027	2028	2029	2030	2031	2032	2033	2034	2035	2036	2037	2038	2039	2040				
Copper	kg	0.00E+00	0.00E+00	0.00E+00	0.00E+00	0.00E+00	9.62E+03	1.26E+04	6.02E+04	7.82E+03	1.25E+05	1.26E+05	1.47E+04	1.51E+05	1.96E+05	1.37E+05	4.28E+03				
Steel	kg	0.00E+00	0.00E+00	0.00E+00	0.00E+00	0.00E+00	5.47E+04	4.41E+04	3.36E+05	2.61E+04	6.89E+05	6.91E+05	5.20E+04	8.45E+05	1.11E+06	7.75E+05	1.43E+04				
Aluminum	kg	0.00E+00	0.00E+00	0.00E+00	0.00E+00	0.00E+00	3.21E+04	1.33E+05	2.16E+05	7.71E+04	4.84E+05	4.89E+05	1.58E+05	5.56E+05	6.83E+05	4.77E+05	4.25E+04				

Table A43. Estimated number of EV batteries disposed on each island.

Location	Unit	2022	2023	2024	2025	2026	2027	2028	2029	2030	2031	2032	2033	2034	2035	2036	2037	2038	2039	2040
EV - Oahu	#	460	732	716	695	944	1244	1351	1634	1137	2022	2437	2898	3426	4010	4640	5330	6093	6914	6914
EV - Hawaii	#	40	20	49	24	65	109	105	159	182	222	315	456	733	1128	1488	1777	2102	2048	2048
EV - Maui	#	92	398	487	141	196	300	268	180	219	774	1242	1492	1898	2893	4147	5640	5449	5386	5386

Table A44. Estimated number of energy storage batteries disposed on each island.

Location	Unit	2022	2023	2024	2025	2026	2027	2028	2029	2030	2031	2032	2033	2034	2035	2036	2037	2038	2039
Res. Oahu	#	45	19	7	22	45	196	1552	1657	4835	4508	4531	4555	1952	2083	2158	2175	2211	2201
Res. Hawaii	#	15	0	0	0	7	224	851	1519	1430	1652	1279	906	404	452	501	518	518	536
Res. Maui	#	3	0	0	0	3	93	245	718	1350	840	984	1129	639	665	665	645	649	646
Res. Kauai	#	0	0	0	0	0	131	114	265	0	788	394							
Com. Oahu	#	1	0	0	0	1	4	32	35	101	94	95	95	41	44	45	46	46	46
Com. Hawaii	#	0	0	0	0	0	5	18	32	30	35	27	19	8	9	10	11	11	11
Com. Maui	#	0	0	0	0	0	2	5	15	28	18	21	24	14	14	14	13	14	14
Com. Kauai	#	0	0	0	0	0	3	2	6	0	16	12	7	7	7	7	7	7	7
Util. Oahu	#	0	0	0	0	0	0	0	0	0	0	0	0	0	0	0	0	0	0
Util. Hawaii	#	0	0	0	0	0	0	0	0	0	0	0	0	0	0	0	0	0	0
Util. Maui	#	6	0	0	0	0	1	0	0	0	0	0	0	0	0	0	0	0	0
Util. Kauai	#	0	0	0	1	0	13	25	0	0	0	0	0	0	0	0	0	0	0
Total Oahu	#	46	20	7	22	46	200	1584	1691	4936	4602	4626	4650	1993	2127	2203	2221	2257	2247
Total Hawaii	#	15	0	0	0	7	229	869	1551	1460	1687	1306	925	412	461	512	529	529	547
Total Maui	#	10	0	0	0	3	95	250	733	1378	857	1005	1152	673	679	679	658	663	639
Total Kauai	#	0	0	0	1	0	146	141	270	0	805	406	7	7	7	7	7	7	7

APPENDIX – FIGURES

Figure A1. Concentration of materials of interest in emerging electronic waste (results for year 2018) in comparison with their average concentration in ore deposits [180].

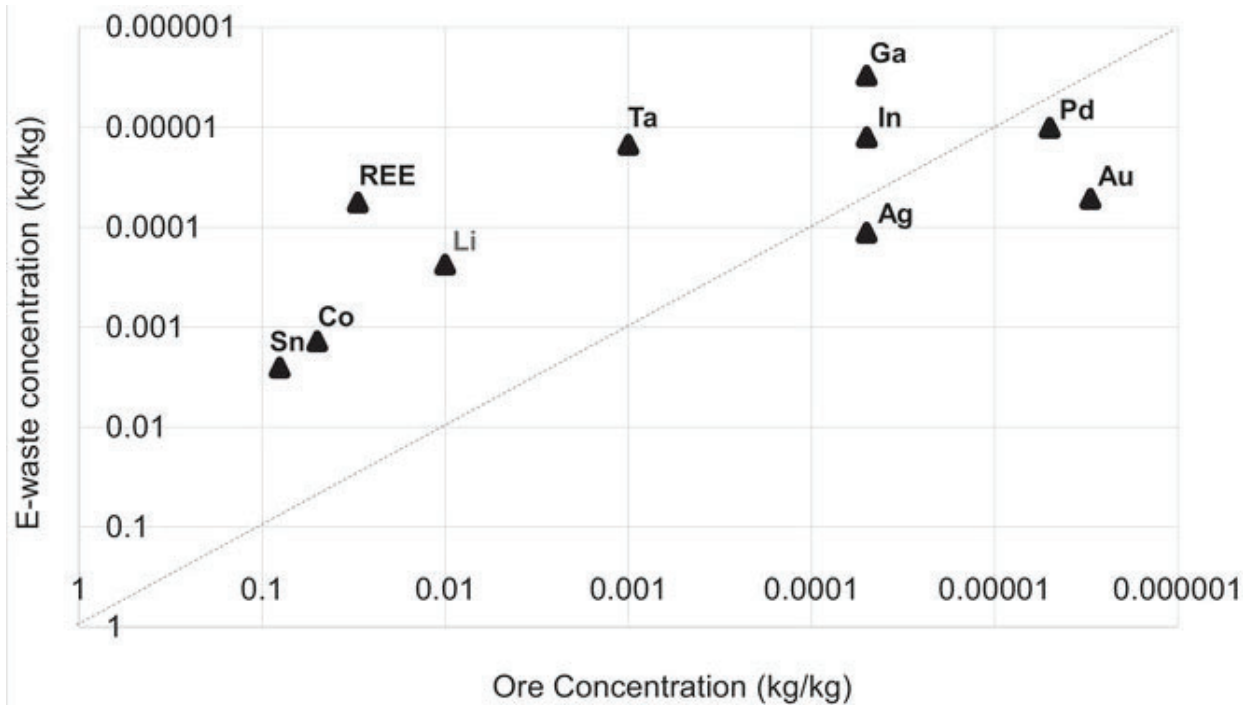
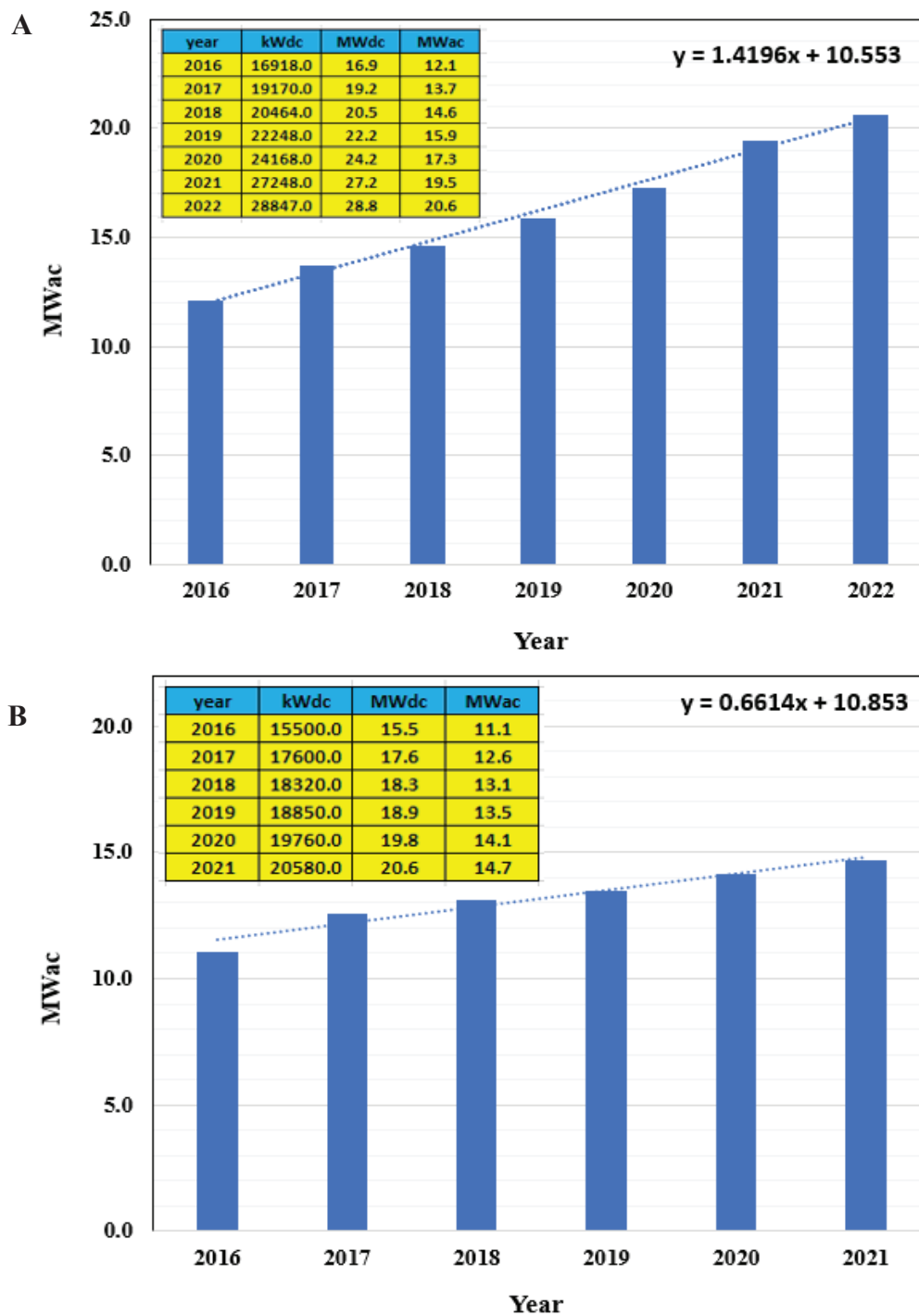
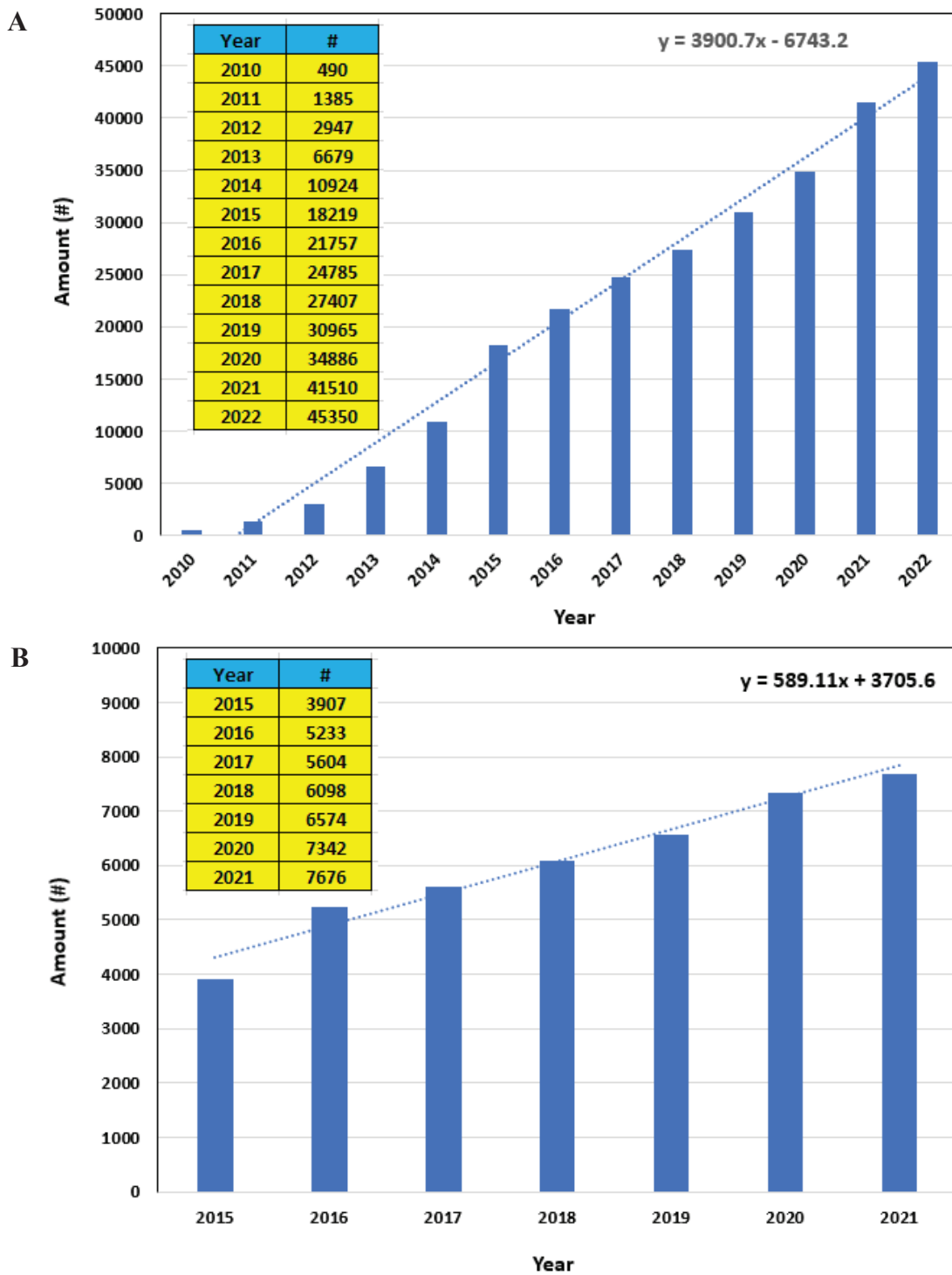

Figure A2. Installed PV on island of Kaua‘i¹¹⁸: Residential (A) and Commercial (B).



¹¹⁸ Data obtained from Jonah Knapp, Associate Engineer, Kaua‘i Island Utility Cooperative.

Figure A3. Installed inverters (micro, string, and battery) on island of Kaua'i¹¹⁹: Residential (A) and Commercial (B).



¹¹⁹ Data obtained from Jonah Knapp, Associate Engineer, Kaua'i Island Utility Cooperative.

Figure A4. Installed energy storage on island of Kaua‘i¹²⁰: Residential (A) and Commercial (B).

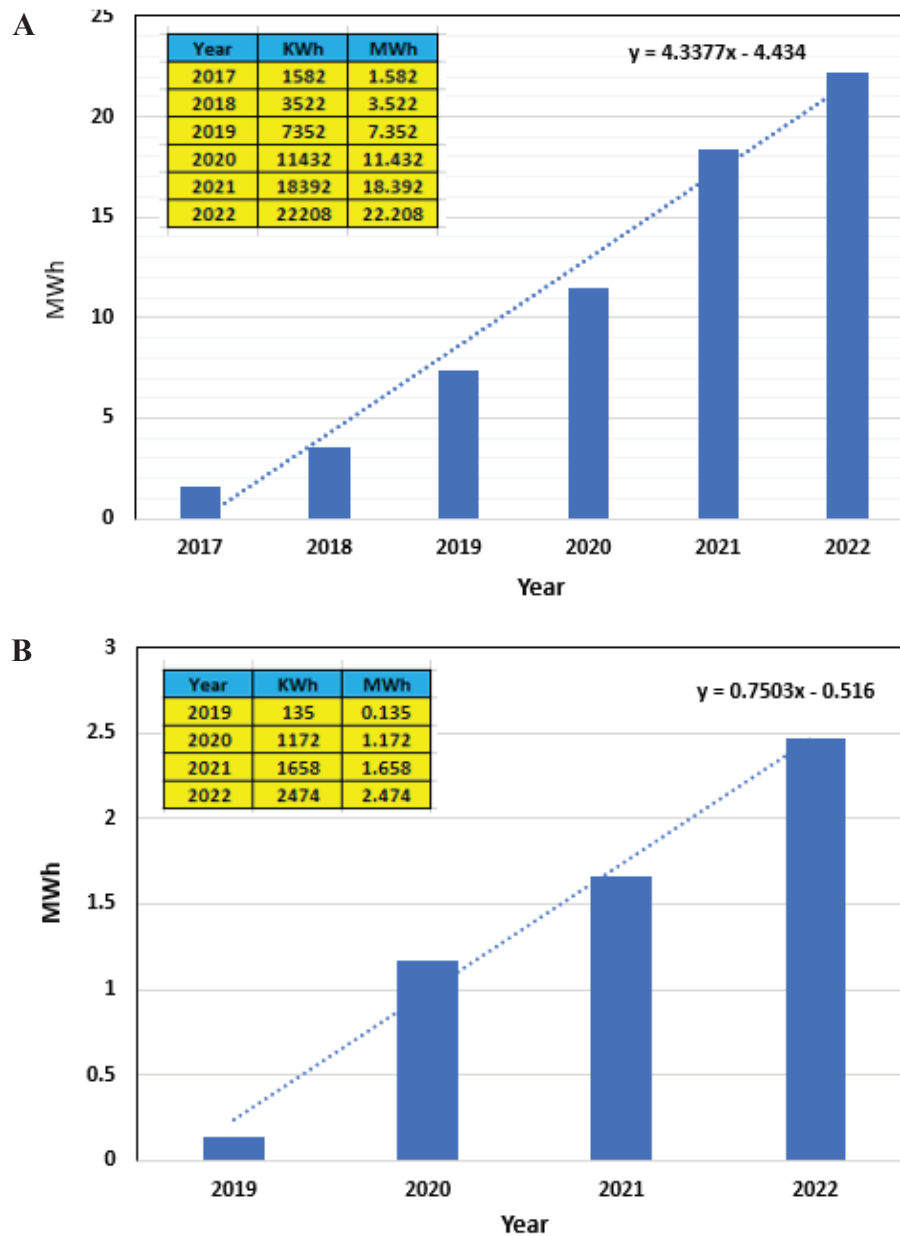

¹²⁰ Data obtained from Jonah Knapp, Associate Engineer, Kaua‘i Island Utility Cooperative.

Figure A5. Prediction of new car and truck purchases in Hawai'i. Legend: All vehicles (blue); electric vehicles (green). Source: Hawai'i Auto Dealers Association [92].

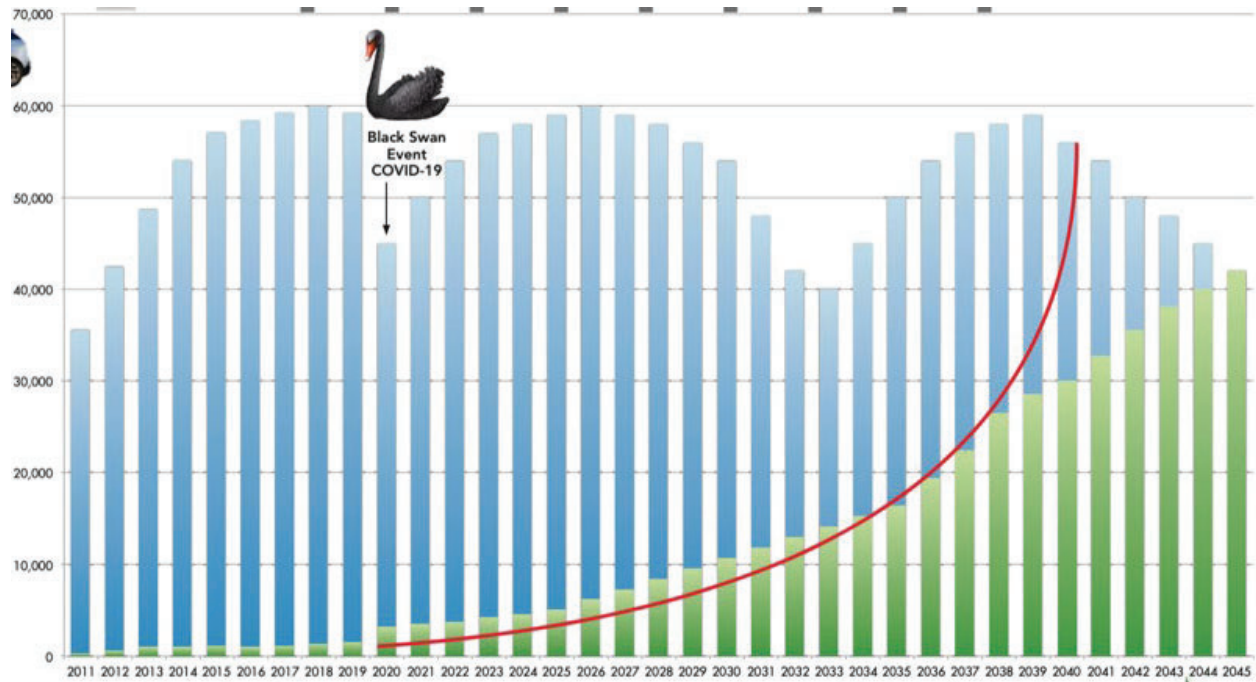
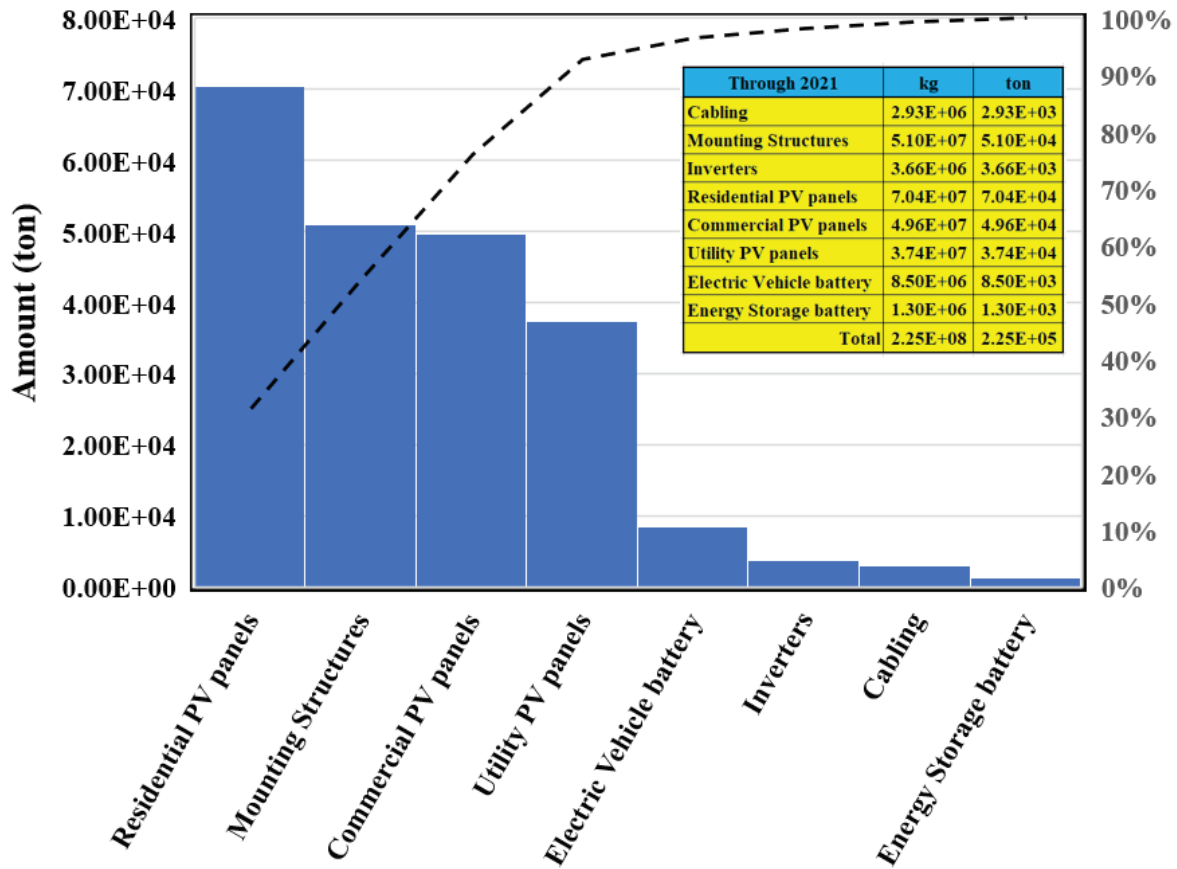

Figure A6. Prediction of total mass of installed clean energy materials¹²¹ through 2021¹²².



¹²¹ This includes PV cabling, mounting structures, inverters, and panels (across all islands and scale), electric vehicle batteries, and energy storage batteries.

¹²² The following assumptions were used in the estimation of values in this plot: 4.5 kg/kWac (residential PV inverter), 1.8 kg/kWac (commercial PV inverter), 2.0 kg/kWac (utility PV inverter), 3.5 kg/kWh (energy storage LIB battery), and 543.6 kg/battery (EV battery).

APPENDIX – COMMUNICATIONS

The list below refers to knowledge or information gained from personal conversations with industry practitioners.

C1: This has occurred, for example, over a 15-year span starting around 2006 at which time larger inverters shifted from 600 volts to 1000 volts and then over the last two to three years to 1500 volts. Personal communication with Sam Vanderhoof, Chief Executive Officer, RecyclePVsolar.com.

C2: Taken from personal conversations with past installers of such off-grid installations and local recyclers who are beginning to receive inquiries as to how to dispose of those materials.

C3: Personal communication with Jonah Knapp, Associate Engineer Kaua'i Island Utility Cooperative.

C4: The majority installed are Tesla's Powerwall whose specification sheet states 14 kWh. Although HECO's IGP report (Table 4.5) estimated the average storage size for residential installations on O'ahu (schedule R customers) is 15.5 KWH), and a personal communication with Tanay Panalal at HECO confirmed the best estimate would be to rest with the Tesla Powerwall.

C5: Typically, residential installations have a single battery and the typical battery installed is Tesla's Powerwall which is rated at 14 kWh. Personal conversations with Tanay Panalal at HECO.

C6: A laboratory test that requires grinding solid material down to pieces approximately one centimeter in diameter, followed by aggressive agitating with an acidic liquid for a defined length of time to simulate the action of acidic water seeping through a landfill. The result is the amounts of various toxic chemicals that leach from the solids are then measured in the leachate and if the amount leached is over the regulatory limit for specific compounds, the material is determined to be hazardous waste.

C7: In Europe, photovoltaic producers have founded the initiative "PV Cycle" whose aim is to create a voluntary, industry-wide take-back and recycling program for end-of-life modules in Europe. Personal conversation with Sam Vanderhoof, Chief Executive Officer, Recycle PV solar.

C8: Universal waste shipping does not require use of the uniform hazardous waste manifest, and so does not require the shipper to have an EPA ID number. A large quantity handler of universal waste is required to notify and obtain an EPA ID number. Personal conversation with Noah Klein, Department of Health, Solid and Hazardous Waste Branch.

C9: Personal conversation with Sam Vanderhoof, Chief Executive Officer, Recycle PV Solar.

C10: These kinds of processes are available at specialized sites, such as HVF West, a certified waste management company that processes government and military waste. <https://www.hvfwest.com/>. Personal conversation with Sam Vanderhoof, Chief Executive Officer, Recycle PV Solar.

C11: The Hazardous waste program in DOH, however, is currently considering a rulemaking proposal to permit deframing by universal waste handlers without requiring a permit. Personal conversation with Noah Klein, DOH Hazardous Waste Branch.

C12: Universal waste electronic item, means a device containing a circuit board, or other complex circuitry, or a video display. Indicators that a device likely contains a circuit board include the presence of a keypad, touch screen, any type of video or digital display, or common electronic ports or connectors, such as serial, parallel, Rj45 (“network”), or USB. Examples of common universal waste electronic items include, but are not limited to: computer central processing unit; computer monitor; portable computer (including notebook, laptop, and tablet computer); devices designed for use with computers (also known as computer peripherals) such as keyboard, mouse, desktop printer, scanner, and external storage drive; server; television; digital video disc (DVD) recorder or player; videocassette recorder or player (VCR); eBook reader; digital picture frame; fax machine; video game equipment; cellular telephone; answering machine; digital camera; portable music or video player; wireless paging device; remote control; and smoke detector. Electronic item does not include a device that is physically a part of, connected to, or integrated within a large piece of equipment that is not meant to be hand-carried by one person (for example, an automobile, large medical equipment, or white goods as defined in chapter 11-58.1). A device is considered physically a part of, connected to, or integrated within a large piece of equipment if the device cannot be easily disconnected from the large equipment by a layperson without specialized training. When a device containing a circuit board or a video display is removed, separated, or separate from the large piece of equipment that it is meant to be a part of, it is a universal waste electronic item. Personal conversation with Noah Klein, DOH Hazardous Waste Branch.

C13: Personal conversations with Sam Vanderhoof, Chief Executive Officer, Recycle PV Solar.

C14: Quote obtained from Sam Vanderhoof, Chief Executive Officer, Recycle PV Solar.

C15: If \$28 to recycle a unit, then more than 50% is shipping cost if this does not include labor to remove from roof. However, for homeowners, replacement is expected to be more common than strict demolition. So, some of the labor is probably something that's needed to be done anyway for replacement. Since labor charge is estimated at more than 50%, this number may be on the

high end. Personal conversation with Sam Vanderhoof, Chief Executive Officer, Recycle PV Solar.

C16: Based upon conversations with mainland recyclers and island-based salvagers who have described giving quotes that price the off-island disposal of PV panels only to never hear back. The general sense is that the cost is prohibitively expensive.

C17: Personal conversations with staff from county refuse divisions and recycle program coordinators.

C18: During the writing of this report, some county staff in counties described entering contracts with regional recyclers that are charging as high as \$1,200 to process and ship a single LIB off island.

C19: Currently, and at a very small scale, the cost of off island disposal of EV LIB are being paid for by counties in Hawai'i from car registration fees. Personal conversation with staff from County recycling coordinators.

C20: This system is already established and the funds are already set up to go to the counties. This concept could be expanded, and the EV owner, will not need to pay all up front. Personal conversation with staff of Hawai'i Department of Health, Solid and Hazardous Waste Branch.

C21: PV panels was not mentioned here as it is assumed that some PV panels are currently being illegally dumped or shredded at recycling centers using processes that are not effectively separating out the underlying precious and toxic metals. Personal conversations with local recyclers and staff from County refuse divisions, and Sam Vanderhoof, Chief Executive Officer, Recycle PV Solar.

C22: Personal conversations with staff from the County refuse divisions.

REFERENCES

1. HECO. *Solar Energy*. Renewable Energy Sources: 2022. Available from: <https://www.hawaiianelectric.com/clean-energy-hawaii/our-clean-energy-portfolio/renewable-energy-sources/solar>. Accessed on 9/24/2022.
2. DOH. *Office of Solid Waste Management Annual Report to the Thirty-First Legislature State of Hawai'i 2022*. State of Hawai'i Department of Health Office of Solid Waste Management. 2022. <https://health.hawaii.gov/shwb/files/2021/12/2022-OSWM-Legislative-Report.pdf>. Accessed on 9/25/2022.
3. Baldwin, S.F. *Quradrenial Technology Review: as Assessment of Energy Technologies and Research Opportunities*. Department of Energy, USA. 2015. Accessed on
4. Parida, B., S. Iniyani, and R. Goic, *Renewable and Sustainable Energy Reviews*. Renewable and Sustainable Energy Reviews, 2011. **15**: p. 1625–1636.
5. Kant, N. and P. Singh, *Review of next generation photovoltaic solar cell technology and comparative materialistic development*. Materials Today: Proceedings, 2021. **56**(6): p. 3460-3470.
6. Paiano, A., *Photovoltaic waste assessment in Italy*. Renewable and Sustainable Energy Reviews, 2015. **41**: p. 99-112.
7. Alajlani, Y., A. Alaswadk, F. Placido, D. Gibson, and A. Diyaf, *Inorganic thin film materials for solar cell applications*. Reference Module in Materials Science and Materials Engineering. 2018: Elsevier B.V.
8. Pagnanelli, F., E. Moscardini, A. Atia, and L. Toro, *Photovoltaic panel recycling: from type-selective processes to flexible apparatus for simultaneous treatment of different types*. Mineral Processing and Extractive Metallurgy (Trans. Inst. Min. Metall. C), 2016. **125**(4): p. 221-227.
9. Jung, B., J. Park, D. Seo, and N. Park, *Sustainable system for raw-metal recovery from crystalline silicon solar panels: from noble-metal extraction to lead removal*. Sustainable Chemistry Engineering, 2016. **4**: p. 4079 - 4083.
10. Granata, G., F. Pagnanelli, E. Moscardini, T. Havlik, and L. Toro, *Recycling of photovoltaic panels by physical operations*. Solar Energy Materials & Solar Cells, 2014. **123**: p. 239 - 248.
11. Flavia, C.S.M., P. Altimari, and F. Pagnanelli, *Recycling of end of life photovoltaic panels: A chemical perspective on process development*. Solar Energy, 2019. **177**: p. 746 - 761.
12. Chowdhury, M.S., K.S. Rahman, T. Chowdhury, N. Nuthammachot, K. Techato, M. Akhtaruzzaman, S.K. Tiong, K. Sopian, and N. Amin, *An overview of solar photovoltaic panels' end-of-life material recycling*. Energy Strategy Reviews, 2020 **27**: p. 100431.
13. Krebs-Moberg, M., M. Pitz, T.L. Dorsette, and S.H. Gheewala, *Third generation of photovoltaic panels: A life cycle assessment*. Renewable Energy, 2021. **164**: p. 556 - 565.
14. Domínguez, A. and R. Geyer, *Photovoltaic waste assessment of major photovoltaic installations in the United States of America*. Renewable Energy, 2019. **133**: p. 1188 - 1200.
15. Isherwood, P.J.M., *Reshaping the Module: The Path to Comprehensive Photovoltaic Panel Recycling*. Sustainability, 2022. **14**: p. 1676
16. Saga, T., *Advances in crystalline silicon solar cell technology for industrial mass production*. NPG Asia Materials, 2010. **2**: p. 96-102.

17. Weckend, S., A. Wade, and G. Heath. *End-Of-Life Management: Solar Photovoltaic Panels*. International Renewable Energy Agency. 2016. Accessed on
18. Dias, P.R., M.G. Benevit, and H.M. Veit, *Photovoltaic solar panels of crystalline silicon: Characterization and separation*. Waste Management & Research, 2016. **34**(3): p. 235–245.
19. Kang, S., S. Yoo, J. Lee, B. Boo, and H. Ryu, *Experimental investigations for recycling of silicon and glass from waste photovoltaic modules*. Renewable Energy, 2012. **47**: p. 152 - 159.
20. Majewski, P., W. Al-shammari, M. Dudley, J. Jit, S.-H. Lee, K. Myoung-Kug, and K. Sung-Jim, *Recycling of solar PV panels- product stewardship and regulatory approaches*. Energy Policy, 2021. **149**: p. 112062.
21. Choi, J.-K. and V. Fthenakis, *Crystalline silicon photovoltaic recycling planning: macro and micro perspectives*. Journal of Cleaner Production, 2014. **66**: p. 443-449.
22. Sander, K., S. Schilling, J. Reinschmidt, K. Wambach, S. Schlenker, A. Müller, J. Springer, D. Fouquet, A. Jelitte, G. Stryi-Hipp, and T. Chrometzka. *Study on the development of a take back and recovery system for photovoltaic products*. Ökopool GmbH. 2007. Accessed on
23. Metz, A., M. Fischer, and J. Trube. *International technology roadmap for photovoltaics (ITRPV): Crystalline silicon technology-current status and outlook*. in *PV Manufacturing in Europe*. 2017. Brussels, Belgium.
24. Monier, V. and M. Hestin. *Study on photovoltaic panels supplementing the impact assessment for a recast of the WEEE directive* BIO Intelligence Service. 2011. Accessed on
25. Dominguez, A. and R. Geyer, *Photovoltaic waste assessment in Mexico*. Resources, Conversation & Recycling, 2017. **127**: p. 29-41.
26. Fthenakis, V. and M. Rauge, *Environmental life-cycle assessment of photovoltaic systems*, in *The Performance of Photovoltaic (PV) Systems: Modelling, Measurement and Assessment*, N. Pearsall, Editor. 2017, Woodhead Publishing. p. 209-232.
27. Albadia, M.H., R.S. Al Abria, M.I. Masouda, K.H. Al Saidi, A.S. Al Busaidi, A. Al Lawati, K. Al Ajmi, and I. Farsie, *Design of a 50 kW solar PV rooftop system*. International Journal of Smart Grid and Clean Energy, 2014. **3**(4): p. 401-409.
28. Hasan, R., S. Mekhilef, M. Seyedmahmoudian, and B. Horan, *Renewable and Sustainable Energy Reviews*. 2017. **67**: p. 1065 - 1080.
29. Kjaer, S.B., J.K. Pedersen, and F. Blaabjerg, *A Review of Single-Phase Grid-Connected Inverters for Photovoltaic Modules*. IEEE Transactions on Industry Applications, 2005. **41**(5): p. 1292 - 1306.
30. Xue, Y., K.C. Divya, G. Griepentrog, M. Liviu, S. Suresh, and M. Manjrekar, *Towards next generation photovoltaic inverters*. EEE Energy Conversion Congress and Exposition, 2011: p. 2467-2474.
31. Dogga, R. and M.K. Pathak, *Recent trends in solar PV inverter topologies*. Solar Energy, 2019. **183**: p. 57-73.
32. Filho, F., Y. Cao, and L.M. Tolbert. *11-level cascaded H-bridge grid-tied inverter interface with solar panels*. 2010. IEEEAPEC.
33. Jungbluth, N., M. Stucki, K. Flury, R. Frischknecht, and S. Büsler. *Life Cycle Inventories of Photovoltaics*. Swiss Federal Office of Energy SFOE. 2012. Accessed on

34. Gautam, A., R. Shankar, and P. Vrat, *End-of-life solar photovoltaic e-waste assessment in India: a step towards a circular economy*. Sustainable Production and Consumption, 2021. **26**: p. 65–77.
35. Tschumperlin, L., P. Stolz, and R. Frischknecht. *Life cycle assessment of low power solar inverters (2.5 to 20 kW)*. treeze Ltd., fair life cycle thinking. 2016. Accessed on
36. de Wild-Scholten, M.J., E.A. Alsema, E.W. ter Horst, M. Bächler, and V.M. Fthenakis. *A cost and environmental impact comparison of grid-connected rooftop and ground based PV systems*. in *21 th European Photovoltaic Solar Energy Conference*. 2006. Dresden, Germany.
37. Siwakoti, Y.P. and F. Blaabjerg, *Common-Ground-Type Transformerless Inverters for Single-Phase Solar Photovoltaic Systems*. IEEE Transactions on industrial electronics, 2018. **65**(3): p. 2100 - 2111.
38. Mayer, J.N., S. Philipps, N.S. Hussein, T. Schlegl, and C. Senkpiel. *Current and future costs of photovoltaics. Long-term scenarios for market development, system prices and LCOE of utility-scale PV systems*. Fraunhofer-Institute for Solar Energy Systems (ISE). 2015. Accessed on
39. Berwal, A.K., S. Kumar, N. Kumari, V. Kumar, and A. Haleem, *Design and analysis of rooftop grid tied 50 kW capacity Solar Photovoltaic (SPV) power plant*. Renewable and Sustainable Energy Reviews, 2017. **77**: p. 1288-1299.
40. Rabanal-Arabach, J., A. Schneider, M. Mrcarica, R. Kopececk, and M. Heckmann. *The need of frameless mounting structures for vertical mounting of bifacial PV modules*. in *32nd European Photovoltaic Solar Energy Conference and Exhibition*. 2017.
41. Bekkelund, K. *A Comparative Life Cycle Assessment of PV Solar Systems*. 2013. Department of Energy and Process Engineering. Norwegian University of Science and Technology. Norway
42. de Wild-Scholten, M. and E.A. Alsema, *Environmental Life Cycle Inventory of Crystalline Silicon Photovoltaic Module Production*. MRS Proceedings, 2005. **895**.
43. Fthenakis, V., H.C. Kim, R. Frischknecht, M. Raugei, P. Sinha, and M. Stucki. *Life Cycle Inventories and Life Cycle Assessments of Photovoltaic Systems*. International Energy Agency Photovoltaic Power Systems Programme. 2011. Accessed on
44. Sinha, P. and M. de Wild-Scholten. *Life cycle assessment of utility-scale CdTe PV balance of System*. . in *27th European Photovoltaic Solar Energy Conference and Exhibition*. 2011.
45. Rahmat Khezri a, Amin Mahmoudi a, and H. Aki, *Optimal planning of solar photovoltaic and battery storage systems for grid-connected residential sector: Review, challenges and new perspectives*. Renewable and Sustainable Energy Reviews, 2022. **153**: p. 111763.
46. Xia, X. and P. Li, *A review of the life cycle assessment of electric vehicles: Considering the influence of batteries*. Science of the Total Environment, 2022. **814**: p. 152870.
47. Piątek, J., S. Afyon, T.M. Budnyak, S. Budnyk, M.H. Sipponen, and A. Slabon, *Sustainable Li-Ion Batteries: Chemistry and Recycling*. Advanced Energy Materials, 2020: p. 2003456.
48. Scrosati, B. and J. Garche, *Lithium batteries: Status, prospects and future*. Journal of Power Sources, 2010. **195**: p. 2419 – 2430.
49. Zhang, J., L. Zhang, F. Sun, and Z. Wang, *An Overview on Thermal Safety Issues of Lithium-ion Batteries for Electric Vehicle Application*. IEEE Access, 2018. **6**: p. 23848.

50. Zhu, P., D. Gastol, J. Marshall, R. Sommerville, V. Goodship, and E. Kendrick, *A review of current collectors for lithium-ion batteries*. Journal of Power Sources, 2021. **485**: p. 229321.
51. Zubi, G., R. Dufo-López, M. Carvalho, and G. Pasaoglu, *The lithium-ion battery: State of the art and future perspectives*. Renewable and Sustainable Energy Reviews, 2018. **89**: p. 292–308.
52. Manimekalai, P., R. Harikumar, and S. Raghavan, *An Overview of Batteries for Photovoltaic (PV) Systems*. International Journal of Computer Applications. **82**(12): p. 28-32.
53. Sun, L., C. Wei, D. Guo, J. Liu, Z. Zhao, Z. Zheng, and Y. Jin, *Comparative Study on Thermal Runaway Characteristics of Lithium Iron Phosphate Battery Modules Under Different Overcharge Conditions*. Fire Technology, 2020. **56**: p. 1555–1574.
54. Wang, L., H. Wu, Y. Hu, Y. Yu, and H. Hunag, *Environmental Sustainability Assessment of Typical Cathode Materials of Lithium-Ion Battery Based on Three LCA Approaches*. Processes, 2019. **7**(2): p. 83.
55. Kallitsis, E., A. Korre, G. Kelsall, M. Kupfersberger, and Z. Nie, *Environmental life cycle assessment of the production in China of lithium-ion batteries with nickel-cobalt-manganese cathodes utilizing novel electrode chemistries*. Journal of Cleaner Production, 2020. **254**: p. 120067.
56. Oliveira, L., M. Messaie, S. Rangaraju, J. Sanfelix, M. Hernandez Rivas, and J. Van Mierlo, *Key issues of lithium-ion batteries – from resource depletion to environmental performance indicators*. Journal of Cleaner Production, 2015. **108, Part A**: p. 354-362
57. Blomgren, G.E., *The development and future of lithium ion batteries*. Journal of The Electrochemical Society, 2017. **164**(1): p. A5019-A5025.
58. Bobba, S., F. Mathieux, and G.A. Blengini, *How will second-use of batteries affect stocks and flows in the EU? A model for traction Li-ion batteries*. Resources, Conservation & Recycling, 2019. **145**: p. 279–291.
59. Pellow, M.A., H. Ambrose, D. Mulvaney, R. Betita, and S. Shaw, *Research gaps in environmental life cycle assessments of lithium ion batteries for grid-scale stationary energy storage systems: End-of-life options and other issues*. Sustainable Materials and Technologies, 2020. **23**: p. e00120.
60. Goriparti, S., E. Miele, F. De Angelis, E.D. Fabrizio, R.P. Zaccaria, and C. Capiglia, *Review on recent progress of nanostructured anode materials for Li-ion batteries*. Journal of Power Sources, 2014. **257**: p. 421-443.
61. Chikkannanava, S.B., D.M. Bernardi, and L. Liu, *A review of blended cathode materials for use in Li-ion batteries*. Journal of Power Sources, 2014. **248**: p. 91-100.
62. Pagliaro, M. and F. Meneguzzo, *Lithium battery reusing and recycling: A circular economy insight*. Heliyon, 2019. **5**: p. e01866.
63. Richa, K., C.W. Babbitt, G. Gaustad, and X. Wang, *A future perspective on lithium-ion battery waste flows from electric vehicles*. Resources, Conservation and Recycling, 2014. **83**: p. 63– 76.
64. Quan, J., S. Zhao, D. Song, T. Wang, W. He, and G. Li, *Comparative life cycle assessment of LFP and NCM batteries including the secondary use and different recycling technologies*. Science of the Total Environment, 2022. **819**: p. 153105.

65. Hess, S., M. Wohlfahrt-Mehrens, and M. Wachtler, *Flammability of Li-Ion Battery Electrolytes: Flash Point and Self-Extinguishing Time Measurements*. Journal of The Electrochemical Society, 2015. **162**(2): p. A3084-A3097.
66. Lander, L., T. Cleaver, M.A. Rajaeifar, V. Nguyen-Tien, R.J.R. Elliott, O. Heidrich, E. Kendrick, J.S. Edge, and G. Offer, *Financial viability of electric vehicle lithium-ion battery recycling*. iScience, 2021. **24**: p. 102787.
67. PatentKochhar, A. and T.G. Johnston, *A process, apparatus, and system for recovering materials from batteries*, W.I.P. Organization, Editor. 2018, Li-Cycle Corporation.
68. Yu, D., Z. Huang, B. Makuza, X. Guo, and Q. Tian, *Pretreatment options for the recycling of spent lithium-ion batteries: A comprehensive review*. Minerals Engineering, 2021. **173**: p. 107218.
69. Marom, R., S.F. Amalraj, N. Leifer, D. Jacob, and D. Aurbach, *A review of advanced and practical lithium battery materials*. Journal of Materials Chemistry, 2011. **21**: p. 9938-9954.
70. Omar, N., P. Van den Bossche, G. Mulder, M. Daowd, J.M. Timmermans, and S. Pauwels. *Assessment of Performance of Lithium Iron Phosphate Oxide, Nickel Manganese Cobalt Oxide and Nickel Cobalt Aluminum Oxide Based cells for Using in Plug-in Battery Electric Vehicle Applications*. in *2011 IEEE Vehicle Power and Propulsion Conference*. 2011.
71. Patel, P., *Improving the Lithium-Ion Battery*. ACS Central Science, 2015. **1**: p. 161-161.
72. Thackeray, M.M., C. Wolverton, and E.D. Isaacs, *Electrical energy storage for transportation—approaching the limits of, and going beyond, lithium-ion batteries*. Energy & Environmental Science 2012. **5**: p. 7854 - 7863.
73. Hesse, H.C., M. Schimpe, D. Kucevic, and A. Jossen, *Lithium-Ion Battery Storage for the Grid—A Review of Stationary Battery Storage System Design Tailored for Applications in Modern Power Grids*. energies, 2107. **10**.
74. Diekmann, J., C. Hanisch, L. Frobose, G. Schalicke, T. Loellhoeffel, A.-S. Folster, and A. Kwadea, *Ecological Recycling of Lithium-Ion Batteries from Electric Vehicles with Focus on Mechanical Processes*. Journal of The Electrochemical Society, 2017. **164**(1): p. A6184 - A6191.
75. Sheikholeslami, M., S.A. Farshad, Z. Ebrahimpour, and Z. Said, *Recent progress on flat plate solar collectors and photovoltaic systems in the presence of nanofluid: A review*. Journal of Cleaner Production. **293**: p. 126119.
76. Michael, J.J., S. Iniyar, and R. Goic, *at plate solar photovoltaic–thermal (PV/T) systems: A reference guide*. Renewable and Sustainable Energy Reviews, 2015. **51**(C): p. 62-88.
77. Alghoul, M.A., M.Y. Sulaiman, B.Z. Azmi, and M.A. Wahab, *Review of materials for solar thermal collectors*. Anti-Corrosion Methods and Materials, 2005. **52**(4): p. 199-206.
78. Clift, D.H. and H. Suehrcke, *Control optimization of PV powered electric storage and heat pump water heaters*. Solar Energy, 2021. **226**: p. 489–500.
79. Fu, R., D. Chung, T. Lowder, D. Feldman, K. Ardani, and R. Margolis. *U.S. Solar Photovoltaic System Cost Benchmark: Q1 2016*. National Renewable Energy Laboratory. 2016. Accessed on
80. HECO. *Quarterly Installed Solar Data*. Our Clean Energy Portfolio 2022. Available from: <https://www.hawaiielectric.com/clean-energy-hawaii/our-clean-energy-portfolio/quarterly-installed-solar-data>. Accessed on 9/24/2022.

81. Mahmoudi, S., N. Huda, and M. Behinia, *Photovoltaic waste assessment: Forecasting and screening of emerging waste in Australia*. Resources, Conservation & Recycling, 2019. **146**: p. 192-205.
82. IRENA. *Renewable Capacity Statistics 2020*. . International Renewable Energy Agency (IRENA). 2020. Accessed on
83. Lumby, B. *A Project Developer's Guide to Utility-scale Solar Photovoltaic Power Plants*. Sgurr Energy. 2015. Accessed on
84. Mondol, J., Y. Yohanis, and B. Norton, *Optimal sizing of array and inverter for grid-connected photovoltaic systems*. Solar Energy, 2006. **80**: p. 1517-1539.
85. Magazine Article Sullivan, T., *Enphase challenging SolarEdge in US inverter market*, in *pv magazine*. 2021.
86. Bhalkar, A., A. Wadekar, M. Wagh, and S. Dengle, *Issues, challenges, and current lacunas in design, and installation of ground mounted solar PV module mounting structure (MMS)*. Materials Today: Proceedings, 2022. **58**(1): p. 128-134.
87. Peters, I.M., C. Breyer, S.A. Jaffer, S. Kurtz, T. Reindl, R. Sinton, and M. Vetter, *The role of batteries in meeting the PV terawatt challenge*. Joule, 2021. **5**(6): p. 1353-1370.
88. Bai, J. and D. Shuai. *Solar PV Battery Installations in Honolulu: 2017, 2018, 2019, 2020*. Department of Business, Economic Development and Tourism. 2017. Accessed on
89. Skeete, J.-P., P. Wells, X. Dong, O. Heidrich, and G. Harper, *Beyond the EVent horizon: Battery waste, recycling, and sustainability in the United Kingdom electric vehicle transition*. Energy Research & Social Science, 2020. **69**: p. 101581.
90. Online Multimedia DBET, *Monthly Energy Data : Historical data from January 2006 to August 2022*, in *Monthly Energy Trends*. 2022.
91. HECO. *Hawaiian Electric Integrated Grid Planning: Inputs and Assumptions*. Hawaiian Electric Company. 2021. Accessed on
92. Magazine Article HADA, in *Hawai'i Dealer*. 2021, Hawai'i Auto Dealers Association: Honolulu.
93. Coffman, M., P. Bernstein, and S. Wee. *Factors affecting EV adoption: a literature review and EV forecast for Hawai'i*. Electric Vehicle Transportation Center. 2015. Accessed on
94. Becker, T.A., I. Sidhu, and B. Tenderich. *Electric vehicles in the United States: a new model with forecasts to 2030*. Center for Entrepreneurship and Technology, University of Berkeley. 2009. Accessed on
95. Government Document Barbose, G., S. Elmallah, and W. Gorman, *Behind-the-Meter Solar+Storage: Market data and trends*, E.A.a.E.I. Division, Editor. 2021, Lawrence Berkely National Laboratory.
96. IRENA. *Innovation landscape brief: Utility-scale batteries*. 2019. Accessed on
97. Yang, C.-J., *Reconsidering solar grid parity*. Energy Policy, 2010. **38**: p. 3270–3273.
98. HECO. *Renewable Project Status Board*. Our Clean Energy Portfolio 2022. Available from: <https://www.hawaiianelectric.com/clean-energy-hawaii/our-clean-energy-portfolio/renewable-project-status-board>. Accessed on 9/24/2022.
99. Conference Paper Fernandes, C.A.F., J.P.N. Torres, M. Morgado, and J.A.P. Morgado, *Aging of Solar PV plants and mitigation of their consequences*, in *IEEE International Power Electronics and Motion Control Conference (PEMC)*. 2016, IEEE: Varna, Bulgaria p. 1240-1247.

100. dos Santos, S.A.A., J.P.N. Torres, C.A.F. Fernandes, and R.A.M. Lameirinhas, *The impact of aging of solar cells on the performance of photovoltaic panels*. Energy Conversion and Management: X, 2021. **10**: p. 100082.
101. Kumar, M. and A. Kumar, *Performance assessment and degradation analysis of solar photovoltaic technologies: A review*. Renewable and Sustainable Energy Reviews, 2017. **78**: p. 554 - 587.
102. Magazine Article Weaver, J., *Recycling solar panels: Making the numbers work*, in *PV magazine*. 2021.
103. Jean, J., M. Woodhouse, and V. Bulovic, *Accelerating Photovoltaic Market Entry with Module Replacement*. Joule, 2019. **3**: p. 2824–2841.
104. eia. *2020 Annual Solar Photovoltaic Module Shipments Report*. U.S. Department of Energy. 2021. Accessed on
105. Gao, D., Y. Zhou, T. Wang, and Y. Wang, *A method for predicting the remaining useful life of lithium-ion batteries based on particle filter using kendall rank correlation coefficient*. Energies, 2020. **13**(6): p. 4183.
106. Anderman, M. *The 2007 advanced automotive battery and ultracapacity industry report*. Advanced Automotive Batteries. 2007. Accessed on
107. Heymans, C., S.B. Walker, S.B. Young, and M. Fowler, *Economic analysis of second use electric vehicle batteries for residential energy storage and load-levelling*. Energy Policy, 2014. **71**: p. 22-30.
108. Omrani, M.M. and H. Jannesari, *Economic and environmental assessment of reusing electric vehicle lithium-ion batteries for load leveling in the residential, industrial and photovoltaic power plants sectors*. Renewable and Sustainable Energy Reviews, 2019. **116**: p. 109413.
109. Ganesan, K. and C. Valderrama, *Anticipatory life cycle analysis framework for sustainable management of end-of-life crystalline silicon photovoltaic panels*. Energy, 2022. **245**: p. 123207.
110. EPRI. *Recycling and Disposal of Battery-Based Grid Energy Storage Systems: A Preliminary Investigation*. EPRI. 2017. Accessed on
111. Cyrs, W.D., H.J. Avens, Z.A. Capshaw, R.A. Kingsbury, J. Sahmel, and B.E. Tvermoes, *Landfill waste and recycling: Use of a screening-level risk assessment tool for end-of-life cadmium telluride (CdTe) thin-film photovoltaic (PV) panels*. Energy Policy, 2014. **68**: p. 524 - 533.
112. EPA. *SW-846 Test Method 1311: Toxicity Characteristic Leaching Procedure*. 2022. Available from: <https://www.epa.gov/hw-sw846/sw-846-test-method-1311-toxicity-characteristic-leaching-procedure>. Accessed on 9/24/2022.
113. Sun, Y., Z. Xie, J. Li, J. Xu, Z. Chen, and R. Naidu, *Assessment of toxicity of heavy metal contaminated soils by the toxicity characteristic leaching procedure*. Environmental Geochemistry and Health 2006. **28**: p. 73:78.
114. Marwede, M. and A. Reller, *Resources, Conservation and Recycling*. Resources, Conservation and Recycling, 2012. **69**: p. 35-49.
115. Corcelli, F., M. Ripaa, E. Leccisi, V. Cigolotti, V. Fiandra, G. Graditi, L. Sannino, M. Tammara, and S. Ulgiati, *Sustainable urban electricity supply chain – Indicators of material recovery and energy savings from crystalline silicon photovoltaic panels end-of-life*. Ecological Indicators, 2018. **94**: p. 37–51.

116. Dias, P., S. Javimczik, M. Benevit, H. Velt, and A.M. Bernardes, *Recycling WEEE: Extraction and concentration of sliver from waste crystalline silicon photovoltaic modules*. Waste Management, 2016. **57**: p. 220 - 225.
117. Klugmann-Radziemska, E., *Current trends in recycling of photovoltaic solar cells and module waste*. Chemistry-Didactics-Ecology-Metrology, 2010. **17**(1-2): p. 89-95.
118. Zeng, D.W., M. Born, and K. Wambach, *Pyrolysis of EVA and its application in recycling of photovoltaic modules*. Journal of Environmental Science, 2004. **16**(6): p. 889 - 893.
119. Farrell, C.C., A.I. Osman, R. Doherty, M. Saad, X. Zhang, A. Murphy, J. Harrison, A.S.M. Vennard, V. Kumaravel, A.H. Al-Muhtase, and D.W. Rooney, *Technical challenges and opportunities in realising a circular economy for waste photovoltaic modules*. Renewable and Sustainable Energy Reviews, 2020. **128**: p. 109911.
120. Magazine Article Kaufmann, K., *It may be safe to put PV panels in landfills, but that doesn't mean we should*, in *pv magazine*. 2020, pv magazine USA
121. Sinha, P., G. Heath, A. Wade, and K. Komoto. *Human Health Risk Assessment Methods for PV Part 3: Module Disposal Risks*. International Energy Agency (IEA) PVPS Task 12, Report T12-16:2020 2020. Accessed on
122. Mahmoudi, S., N. Huda, and M. Behni, *Environmental impacts and economic feasibility of end of life photovoltaic panels in Australia: A comprehensive assessment*. Journal of Cleaner Production, 2020. **260**: p. 120996.
123. Magazine Article Kaufmann, K., *On the road to high-value recycling, storage is ahead of solar*, in *pv magazine*. 2020, pv magazine USA.
124. Fthenakis, V., C. Athias, A. Blumenthal, A. Kulur, J. Magliozzo, and D. Ng, *Sustainability evaluation of CdTe PV: An update* Renewable and Sustainable Energy Reviews, 2020. **123**: p. 109776.
125. Tamarro, M., A. Salluzzo, J. Rimauro, S. Schiavo, and S. Manzo, *Experimental investigation to evaluate the potential environmental hazards of photovoltaic panels*. Journal of Hazardous Materials 2016. **306**: p. 395-405.
126. Tokoro, C., M. Nishi, and Y. Tsunazawa, *Selective grinding of glass to remove resin for silicon-based photovoltaic panel recycling*. Advanced Powder Technology, 2021. **32**: p. 841 - 849.
127. Lu, B., J. Yang, W. Ijomah, W. Wu, and G. Zlamparet, *Perspectives on reuse of WEEE in China: Lessons from the EU*. Resources, Conservation and Recycling, 2018. **135**: p. 83 - 92.
128. EPA. *Solar Panel Recycling*. 2022. Available from: <https://www.epa.gov/hw/solar-panel-recycling>. Accessed on
129. Curtis, T.L., H. Buchanan, G. Heath, L. Smith, and S. Shaw. *Solar Photovoltaic Module Recycling: A Survey of U.S. Policies and Initiatives*. National Renewable Energy Laboratory. 2021. Accessed on
130. Ardente, F., C.E.L. Latunussa, and G.A. Blengini, *Resource efficient recovery of critical and precious metals from waste silicon PV panel recycling*. Waste Management, 2019. **91**: p. 156 - 167.
131. D'Adamo, I., M. Miliacca, and P. Rosa, *Economic Feasibility for Recycling of Waste Crystalline Silicon Photovoltaic Modules*. International Journal of Photoenergy, 2017. **Article ID 4184676**: p. 1-6.

132. Fthenakis, V., *End-of-life management and recycling of PV modules*. Energy Policy, 2000. **28**(14): p. 1051-1058.
133. Magazine Article Wesoff, E. and B. Beetz, *Solar panel recycling in the US — a looming issue that could harm industry growth and reputation*, in *pv magazine*. 2020, pv magazine USA.
134. Latunussa, C.E.L., F. Ardente, G.A. Blengini, and L. Mancini, *Life Cycle Assessment of an innovative recycling process for crystalline silicon photovoltaic panels*. Solar Energy Materials & Solar Cells, 2016. **156**: p. 101-111.
135. Savvilotidou, V., A. Antoniou, and E. Gidarakos, *Toxicity assessment and feasible recycling process for amorphous silicon and CIS waste photovoltaic panels*. Waste Management, 2017. **59**: p. 394 - 402.
136. Sicaa, D., O. Malandrino, S. Supino, M. Testa, and M.C. Lucchetti, *Management of end-of-life photovoltaic panels as a step towards a circular economy*. Renewable and Sustainable Energy Reviews, 2018. **82**: p. 2934 - 2945.
137. Call2Recycle. 2020 – *A Milestone Year: 8.4 Million Pounds of Batteries Recycled* Available from: <https://www.call2recycle.org/2020collectionmilestone/>. Accessed on
138. Morse, I., *A Dead Battery Dilemma*. Science, 2021. **372**(6544): p. 780-783.
139. Government Document DOT, *PHMSA Safety Advisory Notice for the Transportation of Lithium Batteries for Disposal or Recycling*, P.a.H.M.S. Administration, Editor. 2022, US Department of Transportation: Washington, DC.
140. Government Document EPA, *An Analysis of Lithium-ion Battery Fires in Waste Management and Recycling*, O.o.R.C.a. Recovery, Editor. 2021, Environmental Protection Agency.
141. Holleman, M.A. *Lithium-Based Battery Fires in California: A Policy Analysis*. 2019. Department of Public Policy and Administration. California State University, Sacramento.
142. Larsson, F., P. Andersson, P. Blomqvist, and B.-E. Mellander, *Toxic fluoride gas emissions from lithium-ion battery fires*. Scientific Reports, 2017. **7**: p. 10018.
143. Winslow, K.M., S.J. Laux, and T.G. Townsend, *A review on the growing concern and potential management strategies of waste lithium-ion batteries*. Resources, Conservation and Recycling, 2018. **129**: p. 263-277.
144. Lombardo, G., B. Ebin, M.R.S.J. Foreman, B.-M. Britt-Marie Steenari, and M. Petranikova, *Incineration of EV Lithium-ion batteries as a pretreatment for recycling – Determination of the potential formation of hazardous by-products and effects on metal compounds*. Journal of Hazardous Materials, 2020. **393**: p. 122372.
145. Makuza, B., Q. Tian, X. Guo, K. Chattopadhyay, and D. Yu, *Pyrometallurgical options for recycling spent lithium-ion batteries: A comprehensive review*. Journal of Power Sources, 2021. **491**: p. 229622.
146. Patent Tedjar, F. and J.-C. Foudraz, *Method for the mixed recycling of lithium-based anode batteries and cells* USTPO, Editor. 2007, RECUPYL: United States.
147. Magazine Article Oberhaus, D., *The Race To Crack Battery Recycling—Before It's Too Late*, in *WIRED*. 2020.
148. Harper, G., R. Sommerville, E. Kendrick, L. Driscoll, P. Slater, R. Stolkin, A. Walton, P. Christensen, O. Heidrich, S. Lambert, A. Abbott, K. Ryder, L. Gaines, and P. Anderson, *Recycling lithium-ion batteries from electric vehicles*. Nature, 2019. **575**: p. 75-86.

149. Magazine Article Marchant, N., *5 innovators making the electric vehicle battery more sustainable*. 2021, World Economic Forum.
150. Magazine Article Lienert, P., *Ex-Tesla exec Straubel aims to build world's top battery recycler*. 2020, Reuters.
151. Neumann, J., M. Petranikova, M. Meeus, J.D. Gamarra, R. Younesi, M. Winter, and S. Nowak, *Recycling of Lithium-Ion Batteries—Current State of the Art, Circular Economy, and Next Generation Recycling*. *Advanced Energy Materials*, 2022. **12**: p. 2102917.
152. Windisch-Kern, S., E. Gerold, T. Nigl, A. Jandric, M. Altendorfe, B. Rutrecht, S. Scherhauser, H. Raupenstrauch, R. Pomberger, H. Antrekowitsch, and F. Part, *Recycling chains for lithium-ion batteries: A critical examination of current challenges, opportunities and process dependencies* *Waste Management*, 2022. **138**: p. 125 -139.
153. Alfaro-Algaba, M. and F.J. Ramirez, *Techno-economic and environmental disassembly planning of lithium-ion electric vehicle battery packs for remanufacturing*. *Resources, Conservation and Recycling*, 2020. **154**.
154. Meshram, P., A. Mishra, and R. Sahu, *Environmental impact of spent lithium-ion batteries and green recycling perspectives by organic acids – a review*. *Chemosphere*, 2020. **242**: p. 125291.
155. Jacoby, M., *It's Time to Recycle Lithium-Ion Batteries*. *Chemical & Engineering News*, 2019. **97**(28): p. 28-32.
156. Nain, P. and A. Kumar, *Initial metal contents and leaching rate constants of metals leached from end-of-life solar photovoltaic waste: An integrative literature review and analysis* *Renewable and Sustainable Energy Reviews*, 2020. **119**: p. 109592.
157. Seo, B., J.Y. Kim, and J. Chung, *Overview of global status and challenges for end-of-life crystalline silicon photovoltaic panels: A focus on environmental impacts*. *Waste Management*, 2021. **128**: p. 45 - 54.
158. Ding, Y., Z.P. Cano, A. Yu, J. Lu, and Z. Chen, *Automotive Li-Ion Batteries: Current Status and Future Perspectives*. *Electrochemical Energy Reviews*, 2019. **2**: p. 1–28.
159. Hill, N., D. Clarke, L. Blair, and H. Menaude. *Circular Economy Perspectives for the Management of Batteries used in Electric Vehicles*. 2019. Accessed on
160. Dewulf, J., G. Van der Vorst, K. Denturck, H. Van Langenhove, W. Ghyoot, J. Tytgat, and K. Vandeputte, *Recycling rechargeable lithium ion batteries: Critical analysis of natural resource savings*. *Resources, Conservation and Recycling*, 2010. **54**(4): p. 229 - 234.
161. Wade, A., P. Sinha, K. Drozdiak, and E. Brutsch. *Beyond waste – the fate of end-of-life photovoltaic panels from large scale pv installations in the eu the socio-economic benefits of high value recycling compared to re-use*. in *33rd EU PVSEC*. 2017. Amsterdam, The Netherlands.
162. Khawaja, M.K., M. Ghaith, and A. Alkhalidi, *Public-private partnership versus extended producer responsibility for end-of-life of photovoltaic modules management policy*. *Solar Energy*, 2021. **222**: p. 193-201.
163. Walzberg, J., A. Carpenter, and G.A. Heath, *Role of the social factors in success of solar photovoltaic reuse and recycle programmes*. *Nature Energy*, 2021. **6**: p. 913-924.
164. Magazine Article Paben, J., *How the recycling industry is preparing to tackle solar panels*, in *Resource Recycling*. 2021, Resource Recycling, Inc: Portland, Oregon.

165. *Recycling and Disposal of Battery-Based Grid Energy Storage Systems: A Preliminary Investigation*. EPRI. 2017. blob:<https://www.epri.com/a7e73a74-3f48-4500-9fd8-e6b98f78d3bf>. Accessed on
166. Magazine Article Redding, C., *Can Tesla Batteries Be Recycled?*, in *CarShtuff*. 2022.
167. Slattery, M., J. Dunn, and A. Kendall, *Transportation of electric vehicle lithium-ion batteries at end-of-life: A literature review*. Resources, Conservation & Recycling, 2021. **174**: p. 105755.
168. Garole, D.J., R. Hossain, V.J. Garole, V. Sahajwalla, J. Nerkar, and D.P. Duba, *Recycle, Recover and Repurpose Strategy of Spent Li-ion Batteries and Catalysts: Current Status and Future Opportunities*. ChemSusChem, 2020. **13**: p. 3079 – 3100.
169. Lander, L., T. Cleaver, M.A. Rajaeifar, V. Nguyen-Tien, R.J.R. Elliott, O. Heidrich, E. Kendrick, J.S. Edge, and G. Offer, *Financial viability of electric vehicle lithium-ion battery recycling*. iScience, 2021. **24**: p. 102787.
170. Gaines, L., K. Richa, and J. Spangenberg, *Key issues for Li-ion battery recycling*. MRS Energy Sustainability, 2018. **5**: p. E14.
171. Chitre, A., D. Freake, L. Lander, J. Edge, and M.-M. Titirici, *Towards a More Sustainable Lithium-Ion Battery Future: Recycling LIBs from Electric Vehicles*. Batteries & Supercaps, 2020. **3**(11): p. 1126 - 1136.
172. Heelan, J., E. Gratz, Z. Zheng, Q. Wang, M. Chen, D. Apelian, and Y. Wang, *Current and Prospective Li-Ion Battery Recycling and Recovery Processes*. JOM, 2016. **68**: p. pages 2632–2638.
173. Press Release *Pathways To Achieve New Circular Vision for Lithium-Ion Batteries*. 2021, NREL.
174. *The Regulatory Environment for Lithium-Ion Battery Recycling*. ACS Energy Letters, 2022. **7**: p. 736-740.
175. Magazine Article Lambert, F., *Tesla is developing a 'unique battery recycling system'*, in *electrek*. 2019.
176. Magazine Article Carleton, A., *Lithium Battery Fires Are Threatening Recycling as We Know It*, in *Motherboard Tech by Vice*. 2022.
177. Li, L., X. Zhang, M. Li, R. Chen, F. Wu, K. Amine, and J. Lu, *The Recycling of Spent Lithium-Ion Batteries: a Review of Current Processes and Technologies*. Electrochemical Energy Reviews, 2018. **1**(4): p. 461-482.
178. Torabi, F. and P. Ahmadi, *Simulation of battery systems*. 2020, London: Academic Press.
179. Arora, S. and A. Kapoor, *Mechanical Design and Packaging of Battery Packs for Electric Vehicles*, in *Behaviour of Lithium-Ion Batteries in Electric Vehicles*, P. G. and L. B., Editors. 2018, Springer, Cham. p. 175-200
180. Hannan, M.A., M.M. Hoque, Y. Yusof, and P.J. Ker, *State-of-the-Art and Energy Management System of Lithium-Ion Batteries in Electric Vehicle Applications: Issues and Recommendations*. IEEE Access, 2018. **6**: p. 19362 - 19378.
181. Althaf, S., C.W. Babbitt, and R. Chen, *The evolution of consumer electronic waste in the United States*. Journal of Industrial Ecology, 2020. **25**(3): p. 693–706.