

STATE OF HAWAII  
HAWAII STATE PUBLIC LIBRARY SYSTEM  
OFFICE OF THE STATE LIBRARIAN  
44 MERCHANT STREET  
HONOLULU, HAWAII 96813

Senate Committee on Ways and Means  
Informational Budget Briefing  
Wednesday, January 13, 2021  
State Capitol Room 211

**Mission Statement:** The Hawaii State Public Library System (HSPLS) nurtures a lifelong love of reading and learning through its staff, collections, programs, services and physical and virtual spaces.

**Equitable Access**

Our public libraries ensure that all people have equitable access to opportunities and resources for learning 21<sup>st</sup> Century skills and literacies. We connect the collective stories in our communities and open the world of information and ideas through physical and digital technology and resources, providing spaces for community engagement. In order to remain flexible, HSPLS uses a Framework of People, Place, Collections and Programs/Services to make purposeful decisions to support our communities and to prioritize our resources.

**HAWAII STATE PUBLIC LIBRARY SYSTEM  
FRAMEWORK – AREAS OF FOCUS**

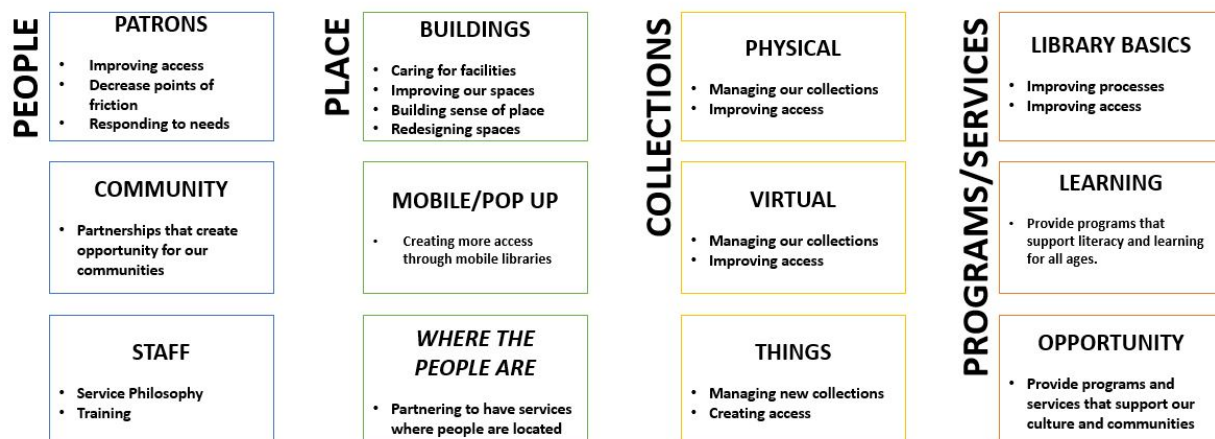

Using the Framework, we measure completion of projects, gauge the impact of new programs and services through community use and feedback, and review the data reflecting use of our physical and digital resources to ensure we are managing resources to meet the needs of our 51 unique communities statewide.

HSPLS continuously reviews and analyzes data related to our outputs of hours, physical and digital resources, partnerships and programs. We also regularly review the number of patrons and their use of physical and digital resources, technology, programs and spaces to identify areas for improvement and resource alignment.

### **Impact of Current Budget Request on Equitable Access**

The current budget request will impact our ability to provide equitable access to our physical resources, programs and spaces. With a budget that is \$3,545,809 less than the amount appropriated in Act 9, Session Laws of Hawaii 2020 and the continued hiring freeze, we do not have the staffing level necessary to prevent ongoing intermittent closures to the public which translates into fewer available days of service. An example of the direct impact is a family that does not have broadband connectivity at home, where the children need to use the library for student assignments and a parent who is applying online for jobs; reduced and inconsistent hours will reduce opportunities for access.

Fewer public service hours at library locations also directly impacts opportunities for government and non-profit partners (local, state, and federal) who use our libraries to connect people to important resources and services, such as programming for: financial support, jobs, taxes, telehealth, passports, and educational support.

While we have improved our digital collections, which are accessible 24/7, there are communities of users who do not have the technology or the connectivity to use these resources. The public libraries also provide locations where many community members learn and practice digital literacy skills necessary for employment in the 21<sup>st</sup> Century. This digital divide widens when our public libraries are not open to provide access to bridge that gap.

The loss of dedicated general funds for the acquisition of books and materials for our library system will also reduce our ability to provide resources to all communities. The public library system provides vetted information and resources that community members use to find information related to health, finances, education, employment and other life decisions.

Currently, the purchase of books and materials, databases, and other resources are paid for using a combination of general and special funds. With the budget reduction, the general fund budget for books and materials has been eliminated to meet the required general fund reduction. This means that all future purchases of books and materials will rely solely on special fines and fees collected by HSPLS. With the current economic crisis and public health restrictions caused by the pandemic, however, the revenue generated by our libraries will not be sufficient for the continued acquisition of books and materials for a statewide library system.

From a data perspective, the use of our resources will decline. It will not necessarily reflect a lack of need, but a lack of access.

### **State-wide Conditions Affecting Operations:**

#### **Library Access During the Pandemic**

Beginning in March 2020, when the pandemic closed our State, HSPLS continued to work with our staff to quickly pivot, to plan and adapt our services to better support communities.

Although our buildings had been closed, for months we continued to work with our staff to use existing funding to transform how we provide library services in light of the pandemic while also looking to accelerating long-desired improvements to our services.

We are proud to share that in a short amount of time, HSPLS staff has been able to quickly launch new electronic services like: online library card applications to create immediate access to digital resources like ebooks, e-audiobooks, and streaming media; set up access to Ancestry.com for Libraries; provide access to Scholastic Teachables, a free online database of tens of thousands of searchable and printable educational materials; and the launch of virtual programs. Increasing our digital resources has been a significant contributor to supporting families and the educational community.

Additionally, on May 19, 2020, HSPLS began to restart direct services to communities based on the safety and health protocols, including Library Take Out, outside WiFi access zones, Computer Time at the Library and now Wiki Visits, which enable a set number of patrons to come into the library and browse for materials or use a public computer for up to 45 minutes. Qualitative and quantitative data shows that our Hawaii communities have relied on access to HSPLS resources throughout the pandemic.

For example, between March 18, 2020 and May 22, 2020, there were 21,849 unique ebook users and 222,254 check-outs of ebooks. By November of 2020, we became the 65<sup>th</sup> library in the country to exceed 1,000,000 ebooks circulated in one year. It demonstrates how important our public library system is to our communities, particularly at a time when so many people are without resources. It is a testament to the desire of keiki, makua, and kupuna to enjoy the simple pleasure of reading and becoming absorbed in our collective stories to feel connected, even as we have been physically distanced.

If we review the number of requests made for library materials for the six-month period between July 2019 - December 2019 and July 2020 - December 2020, there was an huge increase from 636,059 to 974,365 requests. We continue to receive messages from our community like this one:

*“Thank you!! This HSPLS service is a godsend during these times...Mahalos for the library staff’s dedication! Stay Safe. Rowena”* and

*“I really appreciate the Gale Courses; I’ve taken several of them. Upon further investigation, I found that if I were to take these same classes through Ed2go, each one would cost \$149.00. The Hawaii State Library System offers these classes through Gale Course to it’s patrons at no charge. What a fantastic benefit!” Jeanne*

The Hawaii State Public Library System not only loans out our physical and digital collections, but our staff and spaces continue to support other government and non-profit agencies. Here are some examples:

- We were one of the first agencies to volunteer staffing and technology to DLIR to assist with processing unemployment claims. For more than nine months (since April 2020), sixteen HSPLS staff have been processing unemployment claims on behalf of the DLIR Unemployment Division and now provide more skilled technical support to the Unemployment Division and our communities.
- Early on in the pandemic, we loaned the Department of Health 30 laptops from our temporarily closed Ewa Beach Public and School Library for quick access to get their contact tracers up and running, while they waited for new laptops to arrive. Within three days, our IT staff worked to digitally clean and upgrade all 30 laptops for delivery to DOH.

- Our Wahiawa Public Library is temporarily housing Department of Human Services staff who provide services to Women, Infants and Children (WIC) program recipients because they lost their neighboring offices to a fire.
- The U.S. State Department has reached out to HSPLS to help provide additional passport processing services that would otherwise be lost as the federal government continues to reduce its in-person services for our communities.

## **Impacts on Operations**

While we have been able to provide services, there are several challenges that impact our ability to provide services and equitable access statewide.

1) **Staffing** | Eighty percent of the budget is for staffing and the remaining twenty percent is for current expenses (i.e. utilities) to operate 51 branch libraries and two administrative and support offices. With the current budget cuts for FY21, we have had to eliminate 170 student helpers and substitute workers that support operations, care of materials and movement of hundreds of thousands of library materials across 51 locations and six islands. In addition, 69 positions have been unfunded and due to staff leaving and retirements we now have additional vacancies that add up to more than 104 or about 1/5<sup>th</sup> of our positions being unfilled. We have been understaffed on the neighbor islands prior to the pandemic, and due to the hiring freeze and budget reductions, fewer staff means less equitable access for our communities.

Moreover, vital positions that were vacated within the last six months or had been in active recruitment must be filled to continue operations. For example, we have four regional branch manager positions that are vacant (Hilo, Kailua-Kona, Lihue, and Kapolei). These managerial positions are necessary for managing our largest buildings, and providing support for programs, services and resources for their island regions; in some cases, these positions provide island-wide support and direction. While we have requested the authority to fill these critical positions, the hiring freezes have created situations where we do not have the staff to manage our space and resources effectively, which ultimately impacts our system and the community.

2) **Collections** | As discussed above, the HSPLS provides access to physical and digital resources that support literacy, education, and access to the resources that help people find vetted information related to health, employment, financial skill and more, are hampered by reductions to general fund appropriations and a shrinking special fund. If the Legislature were to take all of our special funds – whose sole purpose is to support and fund the acquisition of library books and materials for statewide use - the Hawaii State Public Library System will not be able to continue to support our communities with the resources they need to continue their educational and work-related development.

We would also highlight that as we attempt to meet the growing needs of the community for new electronic resources, such as the expansion of our ebook and audio book collections, we are simultaneously increasing our costs and reducing our revenues. Publishers lease, but do not sell, digital content to us; the more popular a title, the higher the cost to us, as each lease only provides a limited number of uses. At the same time, our digital collection is always returned on time, thereby never generating overdue fines and fees.

**3) Budget Restrictions** | Each year we are restricted from using 5-10% of our budget appropriation. The HSPLS budget is simple. Eighty percent is for staffing and the remaining twenty percent is for current expenses (i.e. utilities). With the current proposed reduction to operate 51 public libraries and support offices with only \$33,578,267.00, an additional restriction of \$1.6M - \$3.3M would mean that we would have to consider some layoffs as it would be difficult to maintain library services without some resources to keep the buildings open and functioning.

While we can request the release of funding, the uncertainty of whether the funding will be available impacts our ability to hire and ensure that we have adequate staffing capacity to create safe spaces to support our communities. In most years, we don't receive all of the budgeted funding until the last couple of months. Receiving funding so late in the budget year has made it very difficult to utilize the funding to initiate projects, to support our payroll and/or fill critical vacancies.

**Federal Funds:**

HSPLS receives approximately \$1.3M through its only source of federal funds, the Library Services and Technology Act (LSTA) grant, provided by the Institute of Museum and Library Services (IMLS). The Grants to States program is a portion of LSTA funding and is distributed to all states based on a population formula; it requires a Maintenance of Effort (MOE) and matching funds on the part of the State.

HSPLS relies on general funds to meet the state match requirements, and any reduction in our budget would directly reduce the amount of federal funds Hawaii receives. LSTA funds completely support our technology, an integrated library collection management system, and online database and learning subscriptions for the public. All of these services are integral to maintaining library operations and supporting Hawaii's communities.

With the deep cuts to the funding for library services, HSPLS will not be able to meet future MOE and matching requirements, which will lead to a direct deduction in our LSTA allotment by the percentage reduction to the MOE. While we can apply for a waiver, there are no guarantees and there is a chance that Hawaii would leave some much needed federal funds on the table.

**Non-General Funds:** HSPLS reports to the Legislature may be viewed at:

<https://www.librarieshawaii.org/about-us/reports/annual-reports/>

**Budget Requests:**

The initial HSPLS budget request was proposed based on the constraints outlined in Finance Memorandum 20-15, Fiscal Biennium 2021-23 Executive Budget Request and Program and Financial Plan for the Period 2021-27, issued by the Department of Budget and Finance on October 2, 2020. A request was made for the operating budget ceiling in general funds for Fiscal Biennium (FB) 2021-2023. The Governor's final decision was a reduction of \$3,545,809 for a total of \$33,578,267 in general funds and a Capital Improvement Project appropriation for health and safety projects of \$5M for fiscal years 2022 and 2023. Attached is a copy of our 2020 Facilities Needs Report and the Department of Accounting and General Services' prioritized list of projects for public library facilities.

With the proposed reduced level of general funds, we anticipate our ability to provide the same level of public services will be impacted in the following ways:

- reduction in the number of public service hours;
- reduction of available materials, public services and programs; and
- delayed building repairs and maintenance.

At this time, more details about specific impacts are not known as they are largely dependent on factors not within HSPLS' control, including: COVID-19 Recovery timeline; potential retirements; the continued hiring freeze; potential furloughs; and approval of the final budget, which may not occur until June 2021.

HSPLS fully recognizes the State's somber economic forecast due to the global COVID-19 pandemic. Our 51 public library locations on six islands are vital visible access points of community support. Now more than ever, as Hawaii seeks to endure and recover from the pandemic and economic crisis, our families and communities will need free, publicly-funded resources.

Our statewide public library system provides communities equal access to technology, high-speed internet, wifi, books, music, movies, education, job-seeking and training tools and

classes, connection to local/state/federal services and programs, and places for our communities to gather and engage as we work our way toward recovery and growth.

Although tough decisions are going to need to be made, and everyone will need to figure out how to manage through the economic storm, we respectfully request that the reductions to the budget of the Hawaii State Public Library System do not cut so deep that there will not be equity of access to resources that support opportunities for resilience and recovery in our communities.

Thank you for your support of our public library system.





Hawaii State Public Library System



# Facilities Needs Report

October 2020



Hawaii State Public Library System

# **FACILITIES NEEDS REPORT**

**October 2020**



Stacey A. Aldrich  
State Librarian

The Hawaii State Public Library System (HSPLS) is made up of 51 unique library locations across six islands. Our public libraries are trusted and valued places that provide opportunities for everyone to learn, grow, and be together as a community. Our responsibility is to ensure that these spaces remain accessible, safe and comfortable for everyone. With sixty percent of HSPLS branches built before 1970 and over forty-six percent of these are 50+ years old we need your support.

As Hawaii builds pathways for recovery, our public library locations are more important than ever. Our public libraries are important social infrastructure for recovery and connection because they are open to all and provide our communities with access to educational resources, internet access, job searching, skill building classes, caring staff to help, and connection to other people in the community with just a library card.

Over the past five years, we are grateful for the support of the Board of Education, Governor, and Legislature and increases in the base budget for Repair and Maintenance funding to \$1M. This funding has enabled us to work on projects in almost every branch to address facility issues.

This year’s report focuses on the CIP projects that are waiting to be addressed across our library system. It also highlights CIP projects that are underway and/or have been completed. The Department of Accounting and General Services has provided all estimates to HSPLS.

HSPLS continues to review, prioritize, and build strategic priorities for improving our public library buildings and spaces to best serve our communities.

If you would like further information, please do not hesitate to contact Mallory Fujitani, Special Assistant to the State Librarian, at (808) 586-3700.

Mahalo for supporting your public libraries,  
Stacey A. Aldrich  
State Librarian

Oahu Libraries:

1. Kaneohe
2. Kailua
3. Waimanalo P&S
4. Hawaii Kai
5. Aina Haina
6. Kaimuki
7. a) Waikiki-Kapahulu  
b) Library for the Blind & Physically Handicapped
8. McCully-Moilili
9. Manoa
10. Hawaii State Library
11. Liliha

12. Kalihi-Palama
13. Salt Lake-Moanalua
14. Aiea
15. Pearl City
16. Ewa Beach P&S
17. Waipahu
18. Kapolei
19. Waianae
20. Mililani
21. Wahiawa
22. Waialua
23. Kahuku P&S
24. Nanakuli

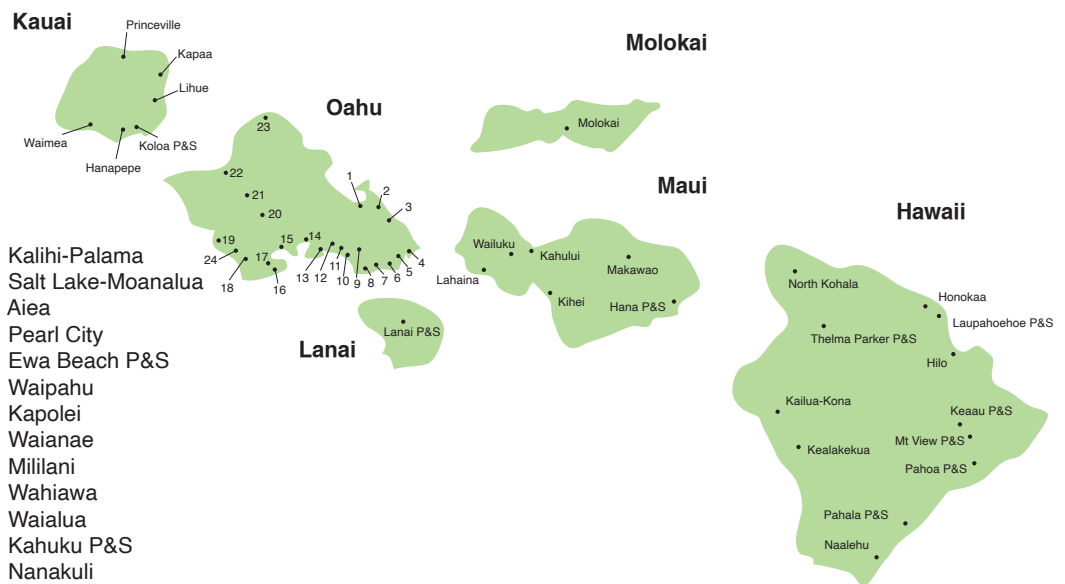

# ISLAND OF HAWAII



## HILO PUBLIC LIBRARY

**Project Costs**..... \$1,446,417

**Projects:**

REPAIR INTERIOR PLASTER DAMAGE FROM EARTHQUAKE	165,375
REPAIR UNEVEN FLOOR - NON-FICTION AREA	59,430
ELEVATOR - UPGRADE FREIGHT/DUMBWTR	806,400
ELECTRICAL UPGRADE	415,212
HEAT ABATEMENT	

**FY20 projects initiated:** Installation of security fencing, replace equipment for wastewater system, heat abatement, and exterior lighting.



## HONOKAA PUBLIC LIBRARY

**Project Costs**..... \$300,090

**Projects:**

PAINT EXTERIOR (2008)	117,915
ROOF - RECOAT (2008)	182,175

**FY20 projects initiated:** Replace air conditioning system.



## KAILUA-KONA PUBLIC LIBRARY

**Project Costs**..... \$717,686

**Projects:**

FIRE ALARM - UPGRADE	105,221
ROOF - RPL GUTTERS	97,871
ECM-2 PHOTOSENS @ PERMITERS	21,987
REPAIR AND PAINT EXTERIOR	236,145
ROOF - RECOAT W/ PV (2012)	256,463

**FY20 projects to be initiated:** Replace air conditioning system.



## KEAAU PUBLIC & SCHOOL LIBRARY

**Project Costs**..... \$2,151,975

**Projects:**

A/C - RPL (2006)	507,959
ECM-2 PHOTOSENS @ PERMITERS	21,987
PV - RECOAT CORRUGATED ROOF	942,680
ELECTRICAL UPGRADE	232,050
CEILING - MEETING ROOM, FRAMING WAVY	91,350
PAINT INTERIOR - PEELING	183,719
ROOF - RECOAT (2009)	172,232

**FY20 projects to be initiated:** Planning study for consolidation and replacement of Mt. View and Keaau public libraries.



## KEALAKEKUA PUBLIC LIBRARY

**Project Costs**..... \$522,743

**Projects:**

ELECTRICAL UPGR (FRONT IS KNOB & TUBE)	160,283
CHECK INTEGRITY OF POST/PIER SUPPORTS	105,735
REPLACE GALVANIZED WATER PIPING	91,350
WINDOWS	165,375

**FY20 projects initiated:** Replace cesspool.



## LAUPAHOEHOE PUBLIC & SCHOOL LIBRARY

**Project Costs**..... \$1,600,368

**Projects:**

A/C - RPL CHILLER/DOORS/LOUVERS	712,289
CONCRETE - SPALLING REBAR	120,110
A/C - RPL AHUS IN CEILING	478,275
PAINT EXTERIOR - RESEAL & PAINT	198,345
REPAIR AND PAINT SAFETY RAILING - CONF RM EXIT	91,350



## MOUNTAIN VIEW PUBLIC & SCHOOL LIBRARY

**Project Costs.....** \$907,211

**Projects:**

A/C - RPL 2 CHILLRS, 2 AHUS, DUCTWORK (1993)	549,413
ECM-2 PHOTOLENS @ PERMITERS	21,987
WINDOWS - WOOD/GLASS LOUVERS	147,840
PAINT EXTERIOR - PEELING	187,971

**FY20 projects initiated:** Planning study for consolidation and replacement of Mt. View and Keaau public libraries.



## NAALEHU PUBLIC LIBRARY

**Project Cost.....** \$1,500,000

Notice to proceed for the expansion and renovation project was issued on July 29, 2019. The new building will be triple the size of the old library (775 sq. ft.), enlarge the parking lot, and include a bathroom inside the library for patrons and staff.

New Naalehu Public Library expected to open in spring 2021.



## NORTH KOHALA PUBLIC LIBRARY

**Project Costs.....** \$1,028,066

**Projects:**

A/C - RPL UNITS (2010)	333,827
WINDOWS SEALS/GASKETS REPAIR/REPLACE	133,455
FIRE ALARM - REPLACED (2010), FIXED (2019)	172,232
PAINT EXTERIOR (2010)	236,145
PARKING - RESEAL	152,408

**FY21 projects to be initiated:** Replace roof, repair or replace wind turbine.



## PAHALA PUBLIC & SCHOOL LIBRARY

**Project Costs.....** \$933,587

**Projects:**

A/C - RPL CHILLER & AHU (1994?)	377,612
ECM-2 PHOTOLENS @ PERMITERS	21,987
WATER LINE - MOVE FROM HYDRANT?	99,488
SLAB CRACK STAFF AREA	59,430
WATER LINE - EXTER FOUNTAIN RPL??	25,452
WASTE/WATER PIPING - CAST/COPPER	232,050
PAINT EXTERIOR (2009)	117,569



## PAHOA PUBLIC & SCHOOL LIBRARY

**Project Costs.....** \$565,824

**Projects:**

PARKING - RPL LIGHTS	77,375
PARKING REPAVE	133,455
TERMITE TENT - 2012	65,772
PAINT EXTERIOR	116,991
ROOF - RECOAT (2009 LAST PAINT)	172,232

**FY20:** Pahoa Public Library planning process to resume.



## THELMA PARKER MEMORIAL PUBLIC & SCHOOL LIBRARY

**Project Costs.....** \$1,537,904

**Projects:**

A/C - MAIN FAN SYSTEM OLD	168,998
ELECTRICAL UPGRADE	95,099
ECM-2 PHOTOLENS @ PERMITERS	21,987
PV - ADD RECOAT CORRUGATED ROOF	942,680
PARKING REPAVE	165,995
LIGHTS EXTER - RPL AT EAVES	77,375
TERMITE TENT	65,772

# ISLAND OF KAUAI



## HANAPEPE PUBLIC LIBRARY

Project Costs..... \$1,149,981

**Projects:**

A/C - RPL 2 CHILLERS & ENCLOSURE AT OLD SIDE	414,750
A/C - RPL 2 AHUS AT OLD SIDE	414,750
ECM-2 INSTALL ELECTRONIC THERMOSTATS	16,212
ECM-3 INSTALL ELECT TIMERS W/ BACKUP	17,252
ECM-5 INSTL LED EXTER LIGHTS, PHOTOCEL	20,255
ECM-4 RPL JALOUSIE TO FIXED WINDOWS	34,713
WASTE/WATER PIPING	232,050



## KAPAA PUBLIC LIBRARY

Project Costs..... \$2,160,344

**Projects:**

ELECTRICAL UPGRADE	249,900
PARKING LOT REPAVE (1/2 COUNTY)	256,484
A/C - RPL 2 LARGE AHUS, 1 SMALL AHU	506,730
ROOF RECOAT - RPL CAPSHEET (2000)	373,086
HALLWAY/RESTROOMS ADA	206,430
WASTE/WATER PIPING	232,050
PAINT EXTERIOR	175,382
FLOORING - RPL CARPET	160,283

**FY20 projects initiated:** Feasibility study for renovation or replacement of library.



## KOLOA PUBLIC & SCHOOL LIBRARY

Project Costs..... \$1,083,306

**Projects:**

A/C - RPL CHILLR/ 3 AHUS (2000)	701,138
ECM-3 INSTALL ELECT TIMERS W/ BACKUP	16,328
ECM-2 INSTALL ELECTRONIC THERMOSTATS	16,443
ECM-5 INSTL LED EXTER LIGHTS, PHOTOCEL	17,598
LIGHTS INTERIOR	133,455
PAINT EXTERIOR	198,345



## LIHUE PUBLIC LIBRARY

Project Costs..... \$162,362

**Projects:**

ECM-3 INSTALL ELECT TIMERS W/ BACKUP	16,328
ECM-2 INSTALL ELECTRONIC THERMOSTATS	16,443
ECM-5 INSTL LED EXTER LIGHTS, PHOTOCEL	25,106
PARKING RESEAL / PERV CONC @ LDG DK	104,486



## PRINCEVILLE PUBLIC LIBRARY

Project Costs..... \$323,400

**Projects:**

LIGHTS EXTERIOR	91,350
LIGHTS INTERIOR	232,050

**FY20 projects initiated:** Replace air conditioning system, repair flooring slab & refloor, repair roof and downspouts, remove exterior planter boxes, address drainage issues and other repairs.



## WAIMEA PUBLIC LIBRARY

Project Costs..... \$115,217

**Projects:**

REPLACE WINDOW TINTING	64,733
ECM-3 INSTALL ELECT TIMERS W/ BACKUP	16,674
ECM-4 INSTL LED EXTER LIGHTS, PHOTOCEL	16,790
ECM-2 INSTALL ELECTRONIC THERMOSTATS	17,021

**FY20 projects initiated:** Renovate and upgrade meeting room, accessible public bathrooms, repair and upgrade parking lot.



**HANA PUBLIC & SCHOOL LIBRARY**

**Project Costs.....** \$281,212

**Projects:**

ENERGY - A/C - PREM EFFIC MTRS AHUS	17,252
ENERGY - LAV/SINK AERATORS	17,252
ENERGY - A/C - CO2 VENT CONTRL	21,987
ENERGY - A/C - HIGH EFFIC AHU W/ VFD	23,258
ENERGY - LOFLO TOILETS/URINALS	24,528
ENERGY - A/C - SEAL DUCTS ING CEILING	30,765
ENERGY - A/C - HI EFFIC CONDENSING UNIT	146,171

**FY20 projects to be initiated:** Structural reinforcement work.



**KAHULUI PUBLIC LIBRARY**

**Project Costs.....** \$1,500,000

**Kahului:** Notice to proceed for the air condition, ceiling and lighting replacement project was issued on August 17, 2020. Completion is estimated for summer 2021. Interior repairs to follow.



**KIHEI PUBLIC LIBRARY**

**Project Costs.....** \$1,338,687

**Projects:**

ENERGY - TIMER SWITCH	16,212
ENERGY - LAV/SINK AERATORS	19,793
ENERGY - A/C - CO2 VENT CONTRL?	21,987
ENERGY - LOFLO TOILETS/URINALS	29,495
ENERGY - A/C - SEAL DUCTS ING CEILING	30,765
GROUNDS - IRRIGATION IMPROVEMENT	96,600
RESTROOM - RPL FIXTURES	36,561
A/C - RPL CHILLER/AHU (2015)	1,087,275



**LAHAINA PUBLIC LIBRARY**

**Project Costs.....** \$997,826

**Projects:**

ROOF - RPL WOOD SHINGLES (1998)	333,827
ELECTRIC UPGRADE	136,784
EXTERIOR LIGHTING - ADD MORE FIXTURES	50,715
PARKING REPAVE	21,987
ENERGY - TINT WINDOWS	99,488
ENERGY - VENT ATTIC SPACE	152,408
TERMITE TREATMENT (2002)	45,948
PAINT EXTERIOR - FOL? (2015)	110,723
FLOORING - RPL ACM VCT (WORK AREA)	45,948



**LANAI PUBLIC & SCHOOL LIBRARY**

**Project Costs.....** \$582,845

**Projects:**

ENERGY - A/C - PREM EFFIC MTRS AHUS	17,252
ENERGY - LAV/SINK AERATORS	17,252
ENERGY - A/C - CO2 VENT CONTRL	20,717
ENERGY - A/C - SEAL DUCTS ING CEILING	21,987
ENERGY - LOFLO TOILETS/URINALS	24,528
ENERGY - A/C - HIGH EFFIC AHU W/ VFD	172,232
ENERGY - A/C - HI EFFIC CONDENSING UNIT	308,879

**FY21 projects initiated:** Replace roof.



**MAKAWAO PUBLIC LIBRARY**

**Project Costs.....** \$1,320,522

**Projects:**

CEILING TILES - CHECK AND SECURE GLUED ON TILES	91,350
A/C - CHILLER/AHU/PKGE, ENCL (DESIGN)	1,064,175
ENERGY - A/C - PREM EFFIC MTRS AHUS	17,598
ENERGY - TIMER SWITCH	17,714
ENERGY - LAV/SINK AERATORS	22,911
ENERGY - LOFLO TOILETS/URINALS	24,990
ENERGY - A/C - CO2 VENT CONTRL	25,799
ENERGY - A/C - HIGH EFFIC AHU W/ VFD	25,799
ENERGY - A/C - SEAL DUCTS ING CEILING	30,188

**FY20 projects initiated:** Feasibility study for expansion.

# MAUI COUNTY LIBRARIES



## MOLOKAI PUBLIC LIBRARY

**Project Cost.....** \$4,500,000

The expansion and renovation project will include a new children's room, meeting room and other additional improvements. Anticipated completion: Fall 2020.



## WAILUKU PUBLIC LIBRARY

**Project Costs.....** \$966,977

**Projects:**

WINDOWS - REPLACE JALOUSIES	192,045
CEILING TILES - RPL @ HAW RM LOOSE (ALL?)	76,104
PAINT INTERIOR - LEAD?	247,800
FLOORING - RPL ACM VCT & CARPET	111,300
FIRE EXIT - SWITCH MGR OFFICE + DOOR	45,255
ENERGY - TIMER SWITCH	232,208
ENERGY - LAV/SINK AERATORS	16,212
ENERGY - LOFLO TOILETS/URINALS	17,829
ENERGY - CEIL FAN - ENRGY STR VARIABLE	28,224

**FY20 projects to be initiated:** Tree removal and roof repair, heat abatement, repair of window screens.



# ISLAND OF OAHU



## AIEA PUBLIC LIBRARY

**Project Costs.....** \$476,070

**Projects:**

ROOF - COAT METAL W/ SKYLITES (2014)	326,550
PARKING - RESEAL	149,520



## AINA HAINA PUBLIC LIBRARY

**Project Costs.....** \$122,493

**Projects:**

ECM-2 INSTLL PERIMETER LIGHT CONTROLS	18,060
TERMITE TREATMENT	45,948
IRRIGATION - RPL SYS	58,485

**FY20 projects initiated:** Upgrade fire alarm system. Construction started Sept 2020.



# ISLAND OF OAHU



## EWA BEACH PUBLIC & SCHOOL LIBRARY

Project Costs..... \$2,370,690

**Projects:**

A/C - RPL 60 TON CHILLER (1990)	478,275
A/C - RPL 7.5 TON PKG MTG RM (2000)	45,255
PARKING REPAVE	261,891
ROOF - RPL PUF (RECOAT 2014)	695,888
ELECTRICAL SYSTEM	152,408
PAINT EXTERIOR (2007)	58,485
IRRIGATION - RPL SYS	353,850
FLOORING - RPL	152,408
PAINT INTERIOR	172,232

**FY20 projects to be initiated:** Replace air conditioning system.



## HAWAII KAI PUBLIC LIBRARY

Project Costs..... \$2,181,879

**Projects:**

WASTE/WATER PIPING	293,475
PARKING REPAVE	192,150
ROOF - RPL GRAVEL BUR (2004)	549,413
ELEVATOR - UPGRADE	489,248
FIRE ALARM UPGRADE W/ ELEVATOR	120,110
ELECTRICAL SYSTEM	417,375
PAINT INTERIOR	120,110

**FY21 projects to be initiated:** Replace master water piping, repave parking lot, reroof.



## HAWAII STATE LIBRARY

Project Costs..... \$7,831,341

**Projects:**

FIRE ALARM - UPGRADE	333,827
A/C - RPL 120 EA FCUS/EF/DUCT HTR (1992)	5,019,525
ECM-1 A/C PUT CW PUMPS ON BLDG CLOCK	17,136
ECM-2 A/C SEWER CREDIT	21,410
ECM-4 A/C INSTL VFDS ON CHW PUMPS	76,451
ECM-3 A/C RESTORE CHW CONTROL VALVES	98,564
ELEVATOR - UPGRADE 2	942,680
WASTE/WATER PIPING	232,050
PAINT INTERIOR - FROM VARIOUS LEAKS	1,089,701

**FY20 projects initiated:** Interior repairs, planning for upgrade of the entire building including electrical and plumbing infrastructure.



## KAHUKU PUBLIC & SCHOOL LIBRARY

Project Costs..... \$672,315

**Projects:**

ECM-1 A/C ADJUST TIME CLOCK	16,097
WINDOW - REPLACE TINT	45,948
WASTE/WATER PIPING	146,171
ELECTRICAL SYSTEM	232,050
FLOORING - RPL	232,050



## KAILUA PUBLIC LIBRARY

Project Costs..... \$1,349,135

**Projects:**

ELECTRICAL - INSTALL MAIN BREAKER	177,450
PV INSTALL	1,025,514
PARKING REPAVE	146,171



## KAIMUKI PUBLIC LIBRARY

Project Costs..... \$1,596,924

**Projects:**

PV - ON NEW ROOF?	172,232
PARKING - INSTLL CORNR GUARDS @ 7 COL	920,850
ELEC - UPGRADE	210,819
PARKING RESEAL UPPER LOT	36,561
FLOORING - RPL	256,463

**FY20 projects initiated:** Upgrade fire alarm system. Lower parking lot drainage project completed.

# ISLAND OF OAHU



## KALIHI-PALAMA PUBLIC LIBRARY

Project Costs..... \$533,684

**Projects:**

WINDOW - REPLACE TINT FRONT PICTURE WINDOWS	97,650
ROOF - RPL CAPSHEET (2004)	172,232
WALKWAY - CT @ COURTYARD PONDING	185,871
PARKING RESEAL (2006)	19,446
IRRIGATION - RPL	58,485



## KANEOHE PUBLIC LIBRARY

Project Costs..... \$2,809,674

**Projects:**

ROOF - RPL SHINGLE/CAPSHEET	16,443
A/C - RPL 6 AHUS HI CEILING (2000)	18,869
ECM-4 INSTL LED EXIT SIGNS	478,275
ECM-3 DELAMP VARIOUS AREAS	549,413
PV - INSTALL?	152,408
PARKING - BLOCK KAM ENTR ADD STALLS?	562,118
RESTROOMS ADA & PARTITIONS	920,850
TERMITE TENT	111,300

**FY21 projects initiated:** Reroof, replace air conditioning system, various repairs.



## KAPOLEI PUBLIC LIBRARY

Project Costs..... \$2,145,581

**Projects:**

ROOF HATCH REPLACE	50,715
A/C - RPL 4 AHUS (2000)	768,075
WALL - RPR CRACKS AT CMU	65,772
ELEVATOR - UPGRADE 1EA	489,248
WASTE/WATER PIPING	232,050
ELECTRICAL SYSTEM	353,850
PARKING RESEAL	185,871



## LIBRARY FOR THE BLIND & PRINT DISABLED

Project Costs..... \$465,486

**Projects:**

ROOF - RPL ASPHALT SHINGLE (2004?)	296,405
ECM-1 INSTALL LED EXIT SIGNS	16,674
FLOORING - RPL ACM TILES	152,408

**FY20 projects to be initiated:** Repave parking lot.



## LILIHA PUBLIC LIBRARY

Project Cost..... \$2,700,000

Notice to proceed for the renovation of Liliha Public Library was issued for January 14, 2019. The project includes replacement of the air conditioning system, complete bathroom renovation, wastewater system repairs, replace roof, structural repairs to walls and parking lot, repair or replacement of windows, interior painting. Upon completion of the repairs to the building, upgrades to the interior of the library will be completed, including replacing the flooring, new signage and furniture. Anticipated completion: Spring 2021.



## MANOA PUBLIC LIBRARY

Project Costs..... \$232,050

**Projects:**

WASTE/WATER PIPING	232,050
--------------------	---------

# ISLAND OF OAHU



## McCULLY-MOILILI PUBLIC LIBRARY

**Project Costs.....** \$2,588,555

**Projects:**

ENERGY - WINDOW GASKET LEAKS	64,733
PARKING REPAVE	366,125
PAINT EXTERIOR	308,879
ECM-2 INSTALL LED EXIT SIGNS	16,905
A/C - RPL 60 TON CHILLER/DRS/LOUVRS	574,592
A/C - RPL 5 AHUS	768,075
ELEVATOR - UPGRADE	489,248

**FY20 projects initiated:** Reroof, PV installation, miscellaneous repairs to building. Upon completion of the repairs will be made to the interior.



## MILILANI PUBLIC LIBRARY

**Project Costs.....** \$1,661,090

**Projects:**

BOOK DROP - EXPAND, SAFETY	120,110
A/C - RPL 8 TON CHLLR & AHU (2008)	206,430
A/C - RPL 50 TON CHLLR & AHU (2008)	659,505
WASTE/WATER PIPING	232,050
ELECTRICAL SYSTEM	293,475
PAINT LOWER PARKING LOT WALLS	149,520

**FY20 projects to be initiated:** Repaving the parking lot. Contruction to start Fall 2020.



## NANAKULI PUBLIC LIBRARY

**FY21:** Initiate plan, design and construction for improvements for exterior space.



## PEARL CITY PUBLIC LIBRARY

**Project Costs.....** \$3,290,648

**Projects:**

A/C - RPL 2 40 TONS CHILLERS	659,505
A/C - INSTALL DUCT SYSTEM / CEILING TILES	768,075
PV - INSTALL	920,850
LOADING DCK - RAISE ELEV & ELEC PANEL	333,827
PAINT EXTERIOR	198,345
PLMBG FIXT - R/R ADA	210,819
PARKING REPAVE	133,455
IRRIGATION - RPL SYS	65,772



## SALT LAKE-MOANALUA PUBLIC LIBRARY

**Project Costs.....** \$1,348,904

**Projects:**

A/C - RPL CRAC SPLIT UNIT	833,196
REPLACE WINDOW TINT	26,460
PAINT EXTERIOR	489,248

**FY20 projects initiated:** Anticipated completion of reroof and PV installation January 2021. Repave parking lot December 2020.



## WAHIAWA PUBLIC LIBRARY

**Project Costs.....** \$1,850,993

**Projects:**

A/C - RPL 30 TON CHILLER	394,538
A/C - RPL 8 AHUS IN CEILING	768,075
ELECTRICAL - UPGRADE 2011 COMPUTERS	172,232
PARKING - RENOV ADA W/ FRONT DOOR	152,408
IRRIGATION INSTALL	77,375
PARKING REPAVE	105,735
A/C - INSTALL EF IN RESTROOMS	28,224
PAINT INTERIOR	152,408

**FY20 projects initiated:** Reroof, repairs to exterior, repair entry area.

# ISLAND OF OAHU



## WAIALUA PUBLIC LIBRARY

**Project Costs**..... \$165,375

**Projects:**

ELECTRICAL SYSTEM	165,375
-------------------	---------

**FY20 projects initiated:** Replace cesspool.  
Construction to Start: Spring 2020.



## WAIANAE PUBLIC LIBRARY

**Project Costs**..... \$826,938

**Projects:**

REPLACE MECH RM DOORS	33,180
IRRIGATION - RPL SYS	126,347
ELECTRICAL - UPGRADE	172,232
PARKING RESEAL	136,784
FLOORING - RPL	126,347
WASTE/WATER PIPING	232,050

**FY20:** Exterior painted



## WAIKIKI – KAPAHULU PUBLIC LIBRARY

**Project Costs**..... \$1,217,696

**Projects:**

A/C - RPL 20 TON PACKAGE UNIT	622,650
A/C - RPL CHLLR & AHU	326,550
ELECTRICAL - UPGRADE / ADD OUTLETS	210,819
TERMITE - TENT	57,677

**FY20 projects to be initiated:** Repave parking lots.



## WAIMANALO PUBLIC & SCHOOL LIBRARY

**Project Costs**..... \$757,523

**Projects:**

ECM-1 DELAMP VARIOUS AREAS	16,905
ROOF - RPL SHINGLE	164,724
WASTE/WATER PIPING	232,050
ELECTRICAL SYSTEM	165,375
PAINT INTERIOR	178,469



## WAIPAHU PUBLIC LIBRARY

**Project Costs**..... \$1,001,144

**Projects:**

A/C - RPL 2 AHUS	622,650
ROOF - RECOAT METAL SEAM	183,225
PARKING REPAVE (W/ CIVIC CTR)	136,784
IRRIGATION IMPROVEMENTS	58,485

	Library	Street Address	City	Zip code	Opening Dates Dy / Mo Yr	
<b>HAWAII</b>	Hilo Public Library	300 Waiianuenue Ave	Hilo	96720	20-Jan	1951
	Honokaa Public Library	45-3380 Mamane St Building #3	Honokaa	96727	5-Jun	1937
	Kailua-Kona Public Library	75-138 Hualalai Rd	Kailua Kona	96740	29-Feb	1992
	Keaau Public & School Library	16-571 Keaau Pahoa Rd	Keaau	96749	30-Sep	1974
	Kealakekua Public Library	81-6619 Mamalahoa Hwy	Kealakekua	96750	14-Oct	1950
	Laupahoehoe Public & School Library	35-2065 Old Mamalahoa Hwy	Laupahoehoe	96764	10-Dec	1973
	Mountain View Public & School Library	18-1235 Volcano Hwy	Mountain View	96771	1-Jun	1977
	Naalehu Public Library	95-5669 Mamalahoa Hwy	Naalehu	96772	26-Feb	1994
	North Kohala Public Library	54-3645 Akoni Pule Hwy	Kapaau	96755	8-Nov	2010
	Pahala Public Library	96-3150 Pikake St	Pahala	96777	2-Mar	1963
	Pahoa Public Library	15-3070 Pahoa Kalapana Rd	Pahoa	96778	3-Sep	1967
	Thelma Parker Memorial Public and School Library	67-1209 Mamalahoa Hwy	Kamuela	96743	Oct	1978
<b>KAUAI</b>	Hanapepe Public Library	4490 Kona Rd	Hanapepe	96716	9-Feb	1950
	Kapaa Public Library	4-1464 Kuhio Hwy	Kapaa	96746	12-Mar	1955
	Koloa Public & School Library	3451 Poipu Rd	Koloa	96756	16-Jun	1976
	Lihue Public Library	4344 Hardy St	Lihue	96766	23-Aug	1969
	Princeville Public Library	4343 Emmalani Dr	Princeville	96722	14-Apr	1999
	Waimea Public Library	9750 Kaunualii Hwy	Waimea	96796	1-Aug	1950
<b>MAUI</b>	Hana Public & School Library	4111 Hana Hwy	Hana	96713	14-Jan	1984
	Kahului Public Library	90 School St	Kahului	96732	9-Feb	1963
	Kihei Public Library	35 Waimahaihai St	Kihei	96753	24-Apr	1996
	Lahaina Public Library	680 Wharf St	Lahaina	96761	2-Mar	1956
	Lanai Public Library	555 Fraser Ave	Lanai City	96763	15-Oct	1975
	Makawao Public Library	1159 Makawao Ave	Makawao	96768	22-Feb	1969
	Wailuku Public Library	251 S High St	Wailuku	96793	21-May	1937
	Molokai Public Library	15 Ala Malama Ave	Kaunakakai	96748	6-Aug	1929
<b>OAHU</b>	Aiea Public Library	99-374 Pohai Pl	Aiea	96701	19-Jul	2014
	Aina Haina Public Library	5246 Kalaniana'ole Hwy	Honolulu	96821	18-Oct	1962
	Ewa Beach Public Library	91-950 North Rd	Ewa Beach	96706	28-Aug	1971
	Hawaii Kai Public Library	249 Lunalilo Home Rd	Honolulu	96825	1-Dec	1973
	Hawaii State Library	478 S King St	Honolulu	96813	1-Feb	1913
	Kahuku Public & School Library	56-490 Kamehameha Hwy	Kahuku	96731	25-Nov	1968
	Kailua Public Library	239 Kuulei Rd	Kailua	96734	28-Dec	1960
	Kaimuki Public Library	1041 Koko Head Ave	Honolulu	96816	17-Jun	1965
	Kalihi Palama Public Library	1325 Kalihi St	Honolulu	96819	9-Sep	1949
	Kaneohe Public Library	45-829 Kamehameha Hwy	Kaneohe	96744	5-Jan	1963
	Kapolei Public Library	1020 Manawai St	Kapolei	96707	21-Aug	2004
	Library for the Blind & Physically Handicapped	402 Kapahulu Ave	Honolulu	96815	31-Mar	1931
	Liliha Public Library	1515 Liliha St	Honolulu	96817	16-Dec	1966
	Manoa Public Library	2716 Woodlawn Dr	Honolulu	96822	9-Jun	2012
	McCully-Moiliili Public Library	2211 S King St	Honolulu	96826	22-Nov	1969
	Mililani Public Library	95-450 Makaimoimo St	Mililani	96789	27-Oct	1984
	Nanakuli Public Library	89-070 Farrington Hwy	Waianae	96792	14-Apr	2018
	Pearl City Public Library	1138 Waimano Home Rd	Pearl City	96782	15-Nov	1969
	Salt Lake/Moanalua Public Library	3225 Salt Lake Blvd	Honolulu	96818	29-Aug	1992
	Wahiawa Public Library	820 California Ave	Wahiawa	96786	20-Jul	1965
	Waialua Public Library	67-068 Kealohanui St	Waialua	96791	Sep	1927
	Waianae Public Library	85-625 Farrington Hwy	Waianae	96792	20-Dec	1966
	Waikiki-Kapahulu Public Library	400 Kapahulu Ave	Honolulu	96815	11-Jul	1952
Waimanalo Public & School Library	41-1320 Kalaniana'ole Hwy	Waimanalo	96795	25-Feb	1978	
Waipahu Public Library	94-275 Mokuola St	Waipahu	96797	18-Mar	1996	

DAVID Y. IGE  
GOVERNOR



CURT T. OTAGURO  
COMPTROLLER  
AUDREY HIDANO  
DEPUTY COMPTROLLER

STATE OF HAWAII  
DEPARTMENT OF ACCOUNTING AND GENERAL SERVICES

P.O. BOX 119, HONOLULU, HAWAII 96810-0119

RA-21.0005

October 6, 2020

TO: Stacey Aldrich, State Librarian  
Hawaii State Public Library System

ATTN: Mallory Fujitani  
Special Assistant

FROM: Curt T. Otaguro, Comptroller *C. Otaguro*

SUBJECT: Project Funding Request for the FY 2022/2023 Budget for the Hawaii State Public Library System

Attached are the prioritized backlog lists of repair/maintenance projects for the upcoming budget request for FY 2022/2023, soft copies were emailed earlier. Upon request, staff from our Central Services Division can attend scope and consultant selection meetings and provide more detailed scope and photos of the high priority projects.

The individual projects were scored and prioritized, by funding type. Also, projects that are ongoing or funded by your Department were removed from the high priority list.

The CIP and General funding needed were based on high priority projects (generally Condition rating '9' and above). Projects rated '9' and higher are energy related or the conditions may begin to affect occupants' operations. The recommended funding for the projects, by source, are:

	<u>CIP Bond Fund</u>	<u>General Fund</u>
FY2022	\$7,036,000	\$1,574,000
FY2023	\$7,028,000	\$1,461,000

If you have any questions, please contact Mr. Dean Shimomura at 831-6730 or [dean.h.shimomura@hawaii.gov](mailto:dean.h.shimomura@hawaii.gov).

Attachments

c: D. Shimomura  
J. Hisano  
S. Shoji

**2020 HSPLS East Oahu Facilities**

<b>TYPE</b>	<b>NO</b>	<b>TY I</b>	<b>BLDG/FACILITY</b>	<b>DESCRIPTION OF WORK</b>	<b>D T</b>	<b>S/CON CC</b>	<b>CONSTR COS</b>	<b>ESTIMATE</b>
29	10	129	HAWAII STATE	<b>HOLD PROJECTS, RENOVATION BEING PLANNED (I2019)</b>	B			
29	10	129	KAPAA	<b>HOLD PROJECTS, STUDY TO RELOCATE FACILITY (I2019)</b>	B			
29	10	129	MAKAWAO	<b>HOLD PROJECTS, PLANNING FACILITY EXPANSION (I2019)</b>	B			
29	10	129	MOLOKAI	<b>HOLD PROJECTS, PROBABLE FACILITY EXPANSION (I2019)</b>	B			
28	10	128	HAWAII STATE	ROOF - RPL TILE & FLAT (RPR 2015)	B	480,900	2,425,500	2,906,400
28	10	128	KOHALA	ROOF - (2010) REPLACE	B	91,350	262,500	353,850
27	10	127	EWA BEACH	A/C - RPL 60 TON CHILLER (1990)	B	114,450	363,825	478,275
27	10	127	HANAPEPE	A/C - RPL 2 CHILLERS & ENCLOSURE AT OLD SIDE	B	102,900	311,850	414,750
27	10	127	HANAPEPE	A/C - RPL 2 AHUS AT OLD SIDE	B	102,900	311,850	414,750
27	10	127	MT. VIEW	A/C - RPL 2 CHILLRS, 2 AHUS, DUCTWORK (1993)	B	124,950	424,463	549,413
23	10	123	KAILUA-KONA	FIRE ALARM - UPGRADE	B	42,735	62,486	105,221
22	10	122	HAWAII KAI	WASTE/WATER PIPING	B	83,475	210,000	293,475
21	10	121	KALIHI	WINDOW - REPLACE TINT FRONT PICTURE WINDOWS	B	39,900	57,750	97,650
21	10	121	MCCULLY	ENERGY - WINDOW GASKET LEAKS	B	28,350	36,383	64,733
19	10	119	KAILUA	ELECTRICAL - INSTALL MAIN BREAKER	B	61,950	115,500	177,450
19	10	119	KEALAKEKUA	ELECTRICAL UPGR (FRONT IS KNOB & TUBE)	B	60,375	99,908	160,283
18	10	118	KAHULUI	PAINT EXTERIOR - SPALL / CMU AT CRTYARD	B	74,550	194,040	268,590
17	10	117	WAILUKU	WINDOWS - REPLACE JALOUSIES	B	66,045	126,000	192,045
12	10	112	HAWAII KAI	PARKING REPAVE	B	65,100	127,050	192,150
12	10	112	MCCULLY	PARKING REPAVE	B	91,350	274,775	366,125
7	10	107	MAKAWAO	CEILING TILES - CHECK AND SECURE GLUED ON TILES	B	38,850	52,500	91,350
7	10	107	WAILUKU	CEILING TILES - RPL @ HAW RM LOOSE (ALL?)	B	33,600	42,504	76,104
28	9	109	HAWAII KAI	ROOF - RPL GRAVEL BUR (2004)	B	124,950	424,463	549,413
28	9	109	KAILUA-KONA	ROOF - RPL GUTTERS	B	38,850	59,021	97,871
28	9	109	LAHAINA	ROOF - RPL WOOD SHINGLES (1998)	B	84,000	249,827	333,827
27	9	108	KOLOA	A/C - RPL CHILLR/ 3 AHUS (2000)	B	155,400	545,738	701,138
27	9	108	LAUPAHOEHOE	A/C - RPL CHILLER/DOORS/LOUVERS	B	150,150	562,139	712,289
27	9	108	MOLOKAI	A/C - RPL 3 CHILLERS (1993)	B	102,900	314,738	417,638
27	9	108	MOLOKAI	A/C - RPL 3 AHU & DUCTS IN ATTIC	B	114,450	363,825	478,275
27	9	108	THELMA PARKER	A/C - MAIN FAN SYSTEM OLD	B	59,850	109,148	168,998
27	9	108	WAIPAHU	A/C - RPL 2 AHUS (1996?)	B	137,550	485,100	622,650
26	9	107	HILO	REPAIR INTERIOR PLASTER DAMAGE FROM EARTHQUAKE	B	60,375	105,000	165,375
26	9	107	HILO	REPAIR UNEVEN FLOOR - NON-FICTION AREA	B	27,930	31,500	59,430

**2020 HSPLS East Oahu Facilities**

<b>TYPE</b>	<b>UNITY</b>	<b>F</b>	<b>BLDG/FACILITY</b>	<b>DESCRIPTION OF WORK</b>	<b>D T</b>	<b>S/CON C</b>	<b>ONSTR COS</b>	<b>TIMATE</b>
26	9	107	MOLOKAI	STRUCT - TERM DAM ROOF & LANAI BEAMS	B	45,150	72,765	117,915
25	9	106	HILO	ELEVATOR - UPGRADE FREIGHT/DUMBWTR	B	171,150	635,250	806,400
23	9	104	HAWAII STATE	FIRE ALARM - UPGRADE	B	84,000	249,827	333,827
19	9	100	LAHAINA	ELECTRIC UPGRADE	B	49,350	87,434	136,784
19	9	100	LAUPAHOEHOE	ELECTRICAL - RESTORE FLOOR OUTLETS	B	21,000	24,255	45,255
19	9	100	THELMA PARKER	ELECTRICAL UPGRADE	B	38,850	56,249	95,099
16	9	97	LAHAINA	EXTERIOR LIGHTING - ADD MORE FIXTURES	B	24,465	26,250	50,715
14	9	95	WAILUKU	FLOORING - RPL ACM VCT & CARPET	B	42,000	69,300	111,300
12	9	93	LAHAINA	PARKING REPAVE	B	15,750	6,237	21,987
12	9	93	OLD AIEA	PARKING REPAVE (ARTISIAN SPRING IN PARKING LOT)	B	74,550	157,500	232,050
12	9	93	PEARL CITY	PARKING REPAVE	B	49,455	84,000	133,455
11	9	92	KAHULUI	RPL CMU WALL @ PROPLINE & CRTYARD	B	84,000	231,000	315,000
10	9	91	MILILANI	BOOK DROP - EXPAND, SAFETY	B	45,150	74,960	120,110
10	9	91	WAIANAE	REPLACE MECH RM DOORS	B	17,430	15,750	33,180



**2020 HSPLS East Oahu Facilities**

<b>TYPE</b>	<b>UNITY</b>	<b>BLDG/FACILITY</b>	<b>DESCRIPTION OF WORK</b>	<b>D T S/CON C</b>	<b>ONSTR COS</b>	<b>TIMATE</b>		
28	10	128	WAIPAHU	ROOF - RECOAT METAL SEAM	G	61,950	121,275	183,225
20	10	120	PAHOA	TERMITE TENT - 2012	G	28,350	37,422	65,772
20	10	120	THELMA PARKER	TERMITE TENT	G	28,350	37,422	65,772
18	10	118	LAUPAHOEHOE	PAINT EXTERIOR - RESEAL & PAINT	G	60,900	137,445	198,345
18	10	118	LAUPAHOEHOE	REPAIR AND PAINT SAFETY RAILING - CONF RM EXIT	G	38,850	52,500	91,350
18	10	118	MT. VIEW	PAINT EXTERIOR - PEELING	G	63,000	124,971	187,971
9	10	109	KIHEI	CUT DOWN TREES - LEANING ON WALL, RUPTURED WATER	G	27,930	31,500	59,430
4	10	104	KEAAU	PAINT INTERIOR - PEELING	G	65,100	118,619	183,719
28	9	109	KEAAU	ROOF - RECOAT (2009)	G	59,850	112,382	172,232
19	9	100	KAPOLEI	HECO/ELEC BOX & COVERS REBUILD/REPLACE	G	26,600	30,000	56,600
18	9	99	MCCULLY	PAINT EXTERIOR	G	84,000	224,879	308,879
18	9	99	PAHOA	PAINT EXTERIOR	G	45,150	71,841	116,991
18	9	99	WAIANAE	PAINT EXTERIOR - SEAL	G	59,850	112,382	172,232
14	9	95	KAHULUI	FLOORING - RPL CARPET IN WORK AREA	G	74,550	162,393	236,943
14	9	95	KEAAU	FLOORING - RPL CARPET	G	38,850	56,249	95,099
12	9	93	KAHULUI	PARKING RESEAL	G	60,900	124,971	185,871
12	9	93	KAIMUKI	PARKING RESEAL UPPER LOT	G	59,850	112,382	172,232
12	9	93	KALIHI	PARKING RESEAL (2006)	G	59,850	112,382	172,232
8	9	89	WAIANAE	IRRIGATION - RPL SYS	G	45,150	81,197	126,347
4	9	85	HILO	PAINT INTERIOR	G	60,900	121,275	182,175
28	8	92	PAHOA	ROOF - RECOAT (2009 LAST PAINT)	G	59,850	112,382	172,232
28	8	92	THELMA PARKER	ROOF - RECOAT	G	59,850	112,382	172,232
21	8	85	SALT LAKE	REPLACE WINDOW TINT	G	15,960	10,500	26,460
20	8	84	HANAPEPE	TERMITE TREATMENT (2013)	G	27,300	31,185	58,485
20	8	84	HAWAII STATE	TERMITE TENT	G	68,250	138,600	206,850
20	8	84	KIHEI	TERMITE TREATMENT	G	34,650	43,775	78,425
18	8	82	EWA BEACH	PAINT EXTERIOR (2007)	G	74,550	187,341	261,891
18	8	82	HONOKAA	PAINT EXTERIOR (2008)	G	45,150	72,765	117,915
18	8	82	KAILUA-KONA	REPAIR AND PAINT EXTERIOR	G	75,600	160,545	236,145
18	8	82	KOHALA	PAINT EXTERIOR (2010)	G	75,600	160,545	236,145
18	8	82	LANAI	PAINT EXTERIOR (2008)	G	60,900	124,971	185,871
18	8	82	MILILANI	PAINT LOWER PARKING LOT WALLS	G	52,500	97,020	149,520
17	8	81	HAWAII STATE	REPLACE/REPAIR WINDOW GASKETS/SEALS	G	83,475	210,000	293,475

**2020 HSPLS East Oahu Facilities**

<b>TYPE</b>	<b>UNITY</b>	<b>ID</b>	<b>BLDG/FACILITY</b>	<b>DESCRIPTION OF WORK</b>	<b>DT</b>	<b>S/CON</b>	<b>CC</b>	<b>CONSTR COST</b>	<b>ESTIMATE</b>	
14	8	78	KAHUKU	FLOORING - RPL	G			52,500	93,671	146,171
14	8	78	KAIMUKI	FLOORING - RPL	G			60,900	149,919	210,819
12	8	76	WAIANAE	PARKING REPAVE	G			49,350	87,434	136,784
9	8	73	KAPOLEI	CONCRETE LANDINGS/PADS CRACKED/SPALL AT SECONDA	G			16600	15000	31,600
8	8	72	EWA BEACH	IRRIGATION - RPL SYS	G			27,300	31,185	58,485
8	8	72	KAPOLEI	IRRIGATION - REPAIR	G			33,600	43,775	77,375
8	8	72	KIHEI	IRRIGATION REPLACE/REPAIR	G			38,850	57,750	96,600
8	8	72	PEARL CITY	IRRIGATION - REPAIR/REPLACE	G			28,350	37,422	65,772
4	8	68	HAWAII STATE	PAINT INTERIOR - FROM VARIOUS LEAKS	G			215,250	874,451	1,089,701



STATE OF HAWAII  
HAWAII STATE PUBLIC LIBRARY SYSTEM  
OFFICE OF THE STATE LIBRARIAN  
44 MERCHANT STREET, HONOLULU, HI 96813  
TEL. 808-586-3704 / FAX 808-586-3715

August 18, 2020

**MEMORANDUM**

TO: David Y. Ige, Governor  
State of Hawaii

VIA: Craig K. Hirai, Director  
Department of Budget & Finance

FROM: Stacey A. Aldrich  
State Librarian

A handwritten signature in blue ink, appearing to read "Stacey A. Aldrich".

SUBJECT: Annual Review and Update of Departmental Organization and Position  
Organization Charts and Functional Statements

As requested in Administrative Directive No. 19-02, we are providing an electronic file of our updated organization and position charts and functional statements. We have also included all delegated and non-delegated organizational changes authorized as of June 30, 2020.

These updates do not include proposed reorganizations that are pending review and any organizational structures which HSPLS may have informally instituted. Please contact our Administrative Services Officer, Vicki Kitajima at 586-3636, if you require any additional information.

Enclosure

DEPARTMENT OF EDUCATION  
HAWAII STATE PUBLIC LIBRARY SYSTEM

ORGANIZATION AND POSITION ORGANIZATION CHARTS  
(As of June 30, 2020)

TABLE OF CONTENTS

	CHART
HAWAII STATE PUBLIC LIBRARY SYSTEM .....	I
OFFICE OF THE STATE LIBRARIAN .....	II
TECHNICAL SERVICES SECTION .....	III
ELECTRONIC SUPPORT SERVICES SECTION .....	IV
LIBRARY DEVELOPMENT SERVICES SECTION .....	V
ADMINISTRATIVE SERVICES BRANCH .....	VI
HAWAII STATE LIBRARY .....	VII
Federal Documents Section; Children's Section; Serials Section; Young Adult Section; Social Science and Philosophy Section; Business, Science, and Technology Section; Hawaii and Pacific Section .....	VII-A
Art, Music, and Recreation Section & Audio Visual Section; Language, Literature, and History Section; Library Operations Section .....	VII-B
Library for the Blind and Physically Handicapped .....	VIII
PUBLIC LIBRARIES BRANCH .....	IX
<i>West Oahu / Hawaii Region Libraries</i> .....	IX-A
<u>West Oahu Region</u> Aiea Public Library; Ewa Beach Public and School Library; Kahuku Public and School Library; Kapolei Public Library .....	IX-B
Mililani Public Library; Nanakuli, Pearl City Public Library; Salt Lake-Moanalua Public Library .....	IX-C
Wahiawa Public Library; Waialua Public Library; Waianae Public Library Waipahu Public Library. ....	IX-D
<u>Hawaii Region</u> Hilo Public Library; Honokaa Public Library; Kailua-Kona Public Library Keaau Public and School Library; Kealahou Public Library .....	IX-E
Laupahoehoe Public and School Library; Mountain View Public and School Library; Naalehu Public Library; North Kohala Public Library .....	IX-F
Pahoa Public and School Library; Thelma Parker Memorial Public and School Library; .....	IX-G

DEPARTMENT OF EDUCATION  
HAWAII STATE PUBLIC LIBRARY SYSTEM

ORGANIZATION AND POSITION ORGANIZATION CHARTS  
(As of June 30, 2020)

TABLE OF CONTENTS

	CHART
<i>East Oahu / Maui County / Kauai Region Libraries</i> .....	IX-H
<u>East Oahu Region</u>	
Aina Haina Public Library; Hawaii Kai Public Library; Kailua Public Library Kaimuki Public Library; Kalihi-Palama Public Library .....	IX-I
Kaneohe Public Library; Liliha Public Library; Manoa Public Library; McCully-Moiliili Public Library .....	IX-J
Waikiki-Kapahulu Public Library; Waimanalo Public and School Library. ....	IX-K
<u>Maui County Region</u>	
Hana Public and School Library; Kahului Public Library; Kihei Public Library; Lahaina Public Library; Makawao Public Library; Wailuku Public Library; Lanai Public and School Library; Molokai Public Library .....	IX-L
<u>Kauai Region</u>	
Hanapepe Public Library; Kapaa Public Library; Koloa Public and School Library; Lihue Public Library; Princeville Public Library; Waimea Public Library .....	IX-M

STATE OF HAWAII  
DEPARTMENT OF EDUCATION  
HAWAII STATE PUBLIC LIBRARY SYSTEM  
ORGANIZATION CHART

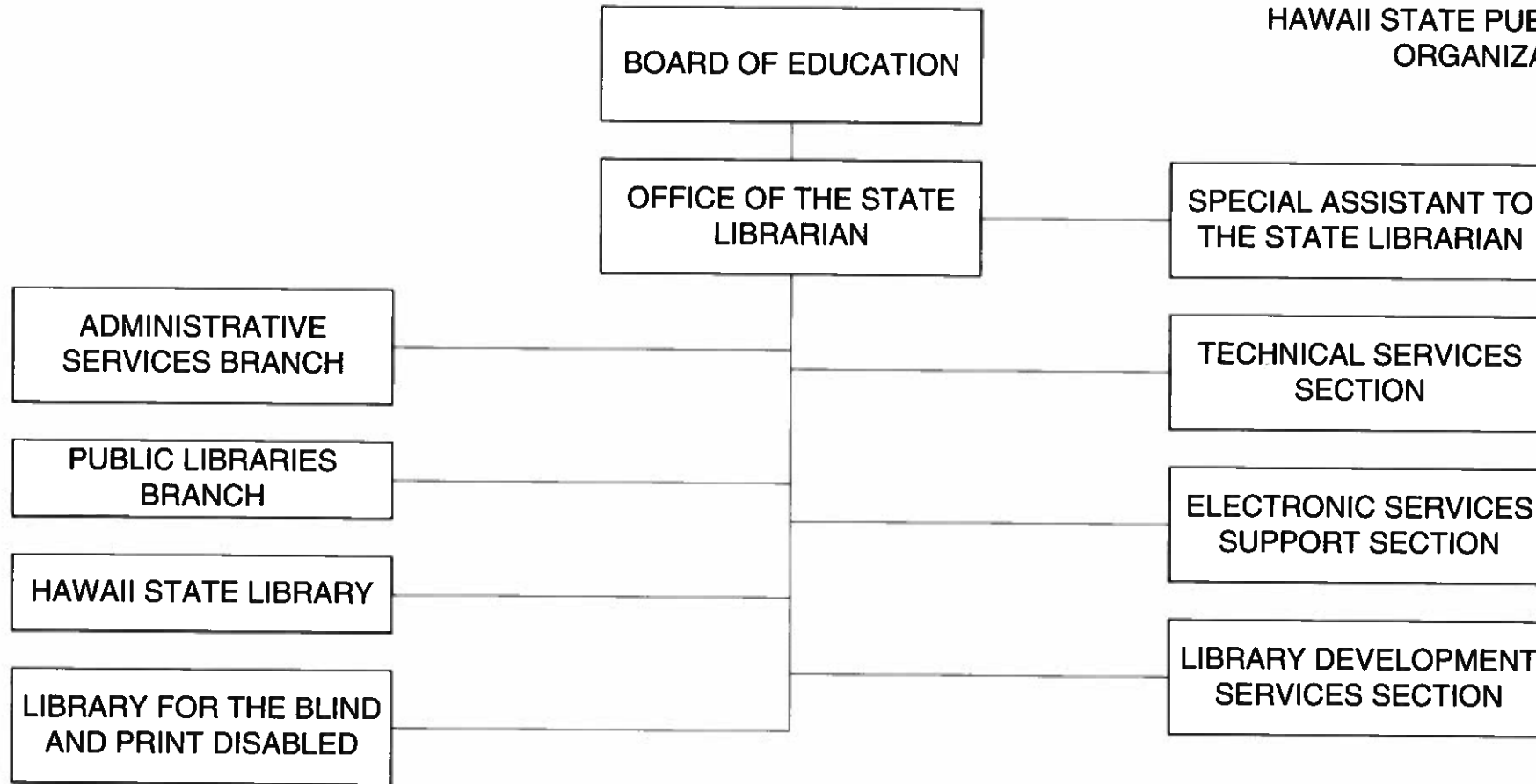

As of 6/30/20

  
\_\_\_\_\_  
Stacey A. Aldrich  
State Librarian

CHART I

1/ Position to be redescribed

STATE OF HAWAII  
DEPARTMENT OF EDUCATION  
HAWAII STATE PUBLIC LIBRARY SYSTEM  
POSITION ORGANIZATION CHART  
OFFICE OF THE STATE LIBRARIAN

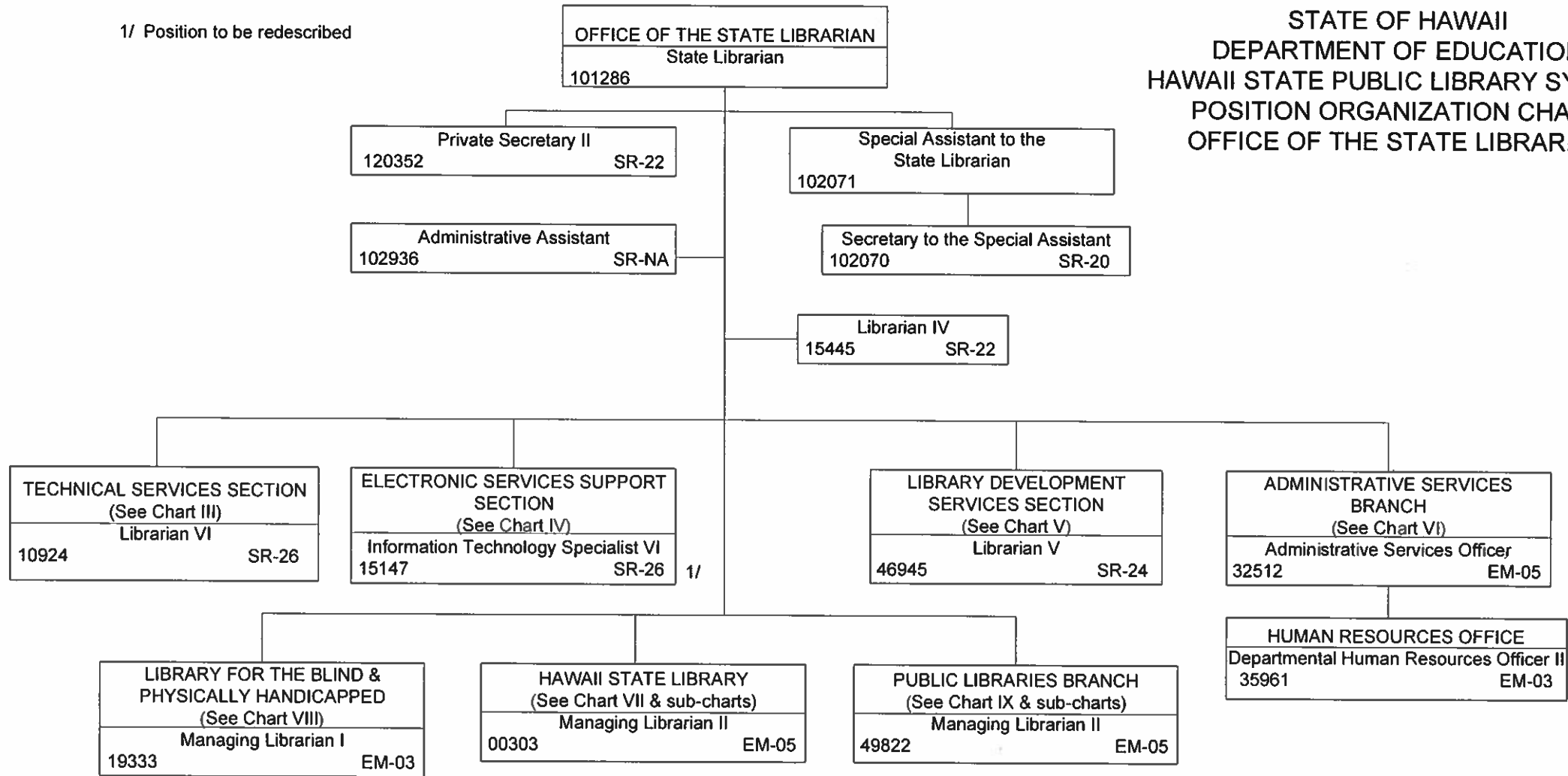

As of 6/30/20

*Stacey A. Aldrich*  
Stacey A. Aldrich  
State Librarian

CHART II

STATE OF HAWAII  
 DEPARTMENT OF EDUCATION  
 HAWAII STATE PUBLIC LIBRARY SYSTEM  
 POSITION ORGANIZATION CHART  
 TECHNICAL SERVICES SECTION

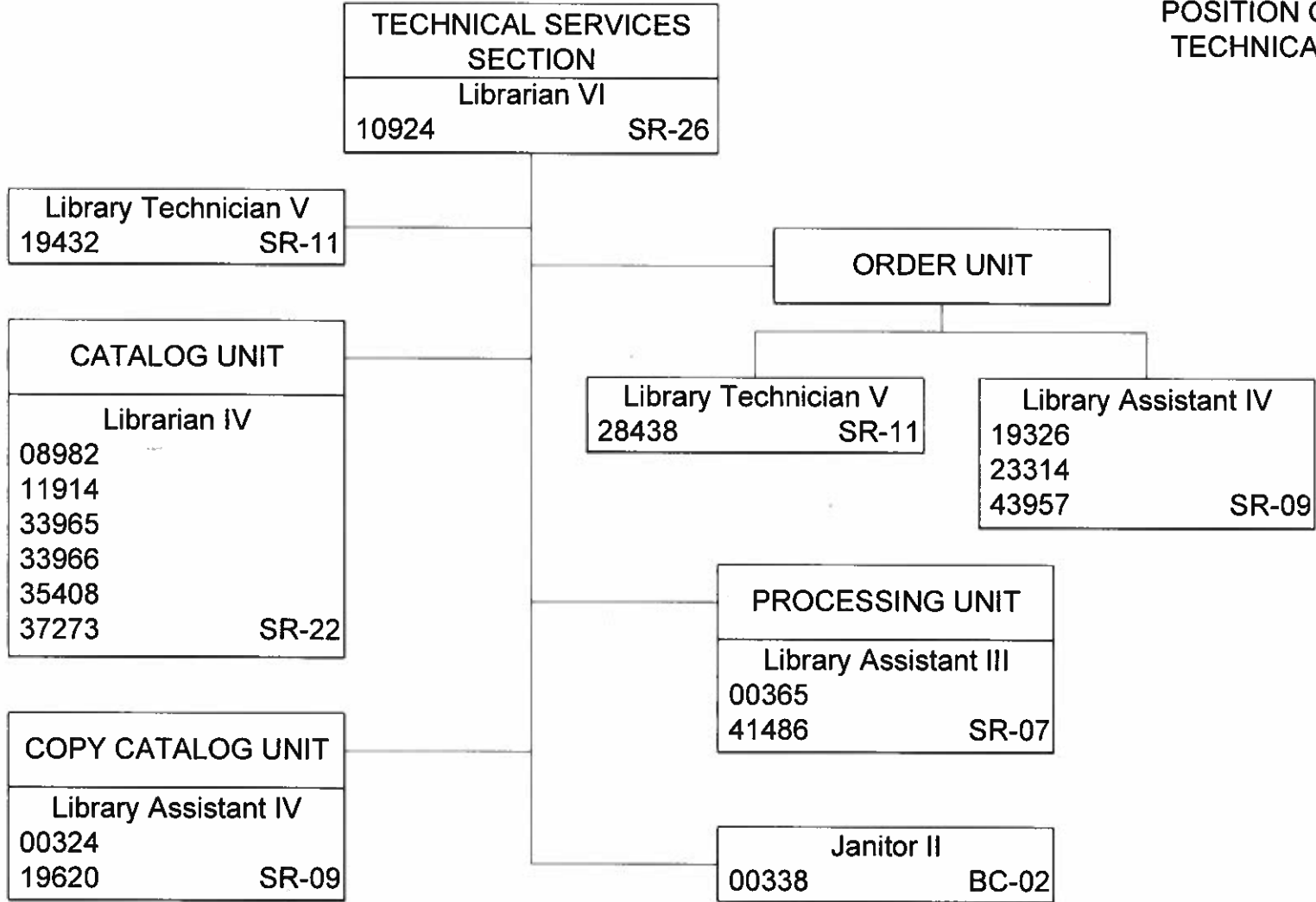

As of 6/30/20

CHART III

*Stacey A. Aldrich*  
 \_\_\_\_\_  
 Stacey A. Aldrich  
 State Librarian



STATE OF HAWAII  
 DEPARTMENT OF EDUCATION  
 HAWAII STATE PUBLIC LIBRARY SYSTEM  
 POSITION ORGANIZATION CHART  
 ELECTRONIC SERVICES SUPPORT SECTION

1/ To be redescribed

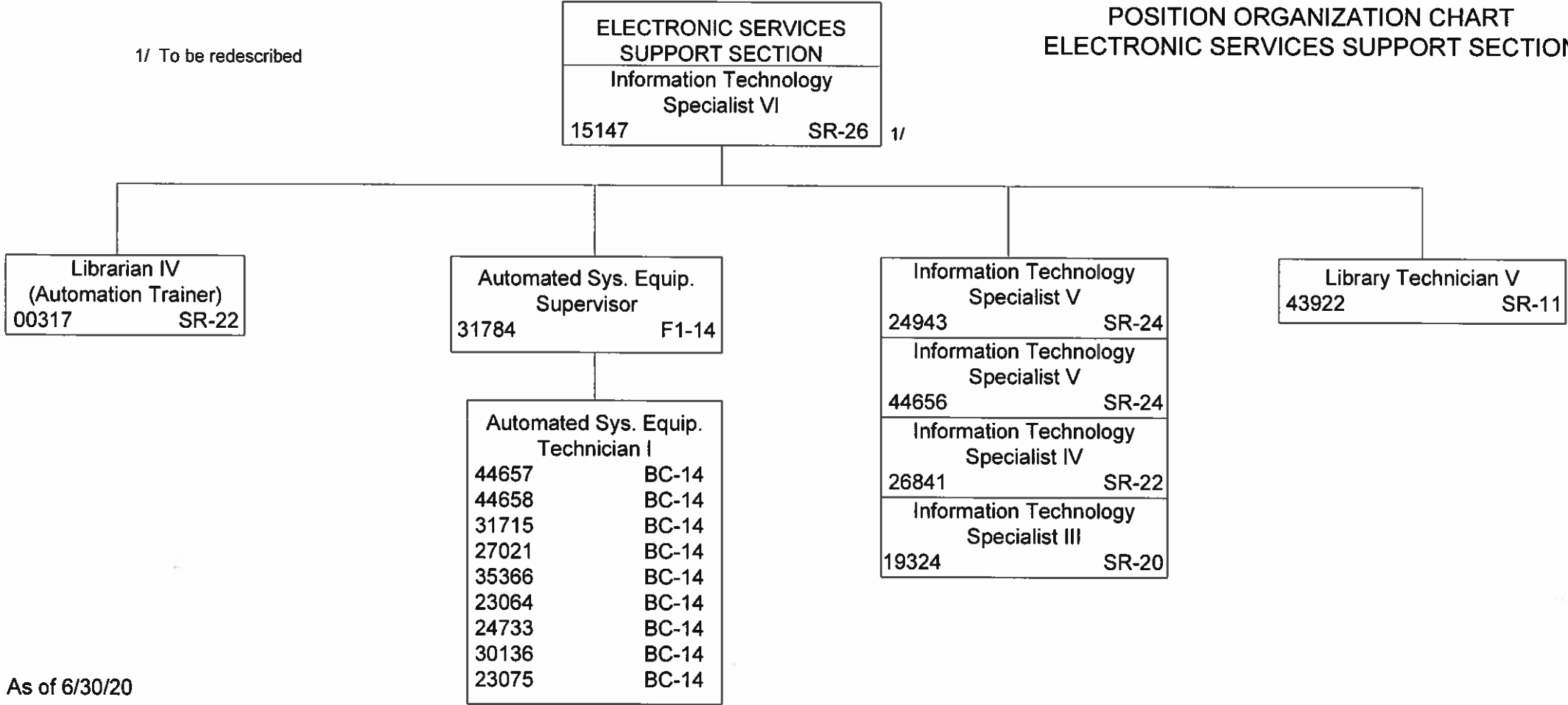

As of 6/30/20

  
 Stacey A. Aldrich  
 State Librarian

CHART IV

STATE OF HAWAII  
DEPARTMENT OF EDUCATION  
HAWAII STATE PUBLIC LIBRARY SYSTEM  
POSITION ORGANIZATION CHART  
LIBRARY DEVELOPMENT SERVICES SECTION

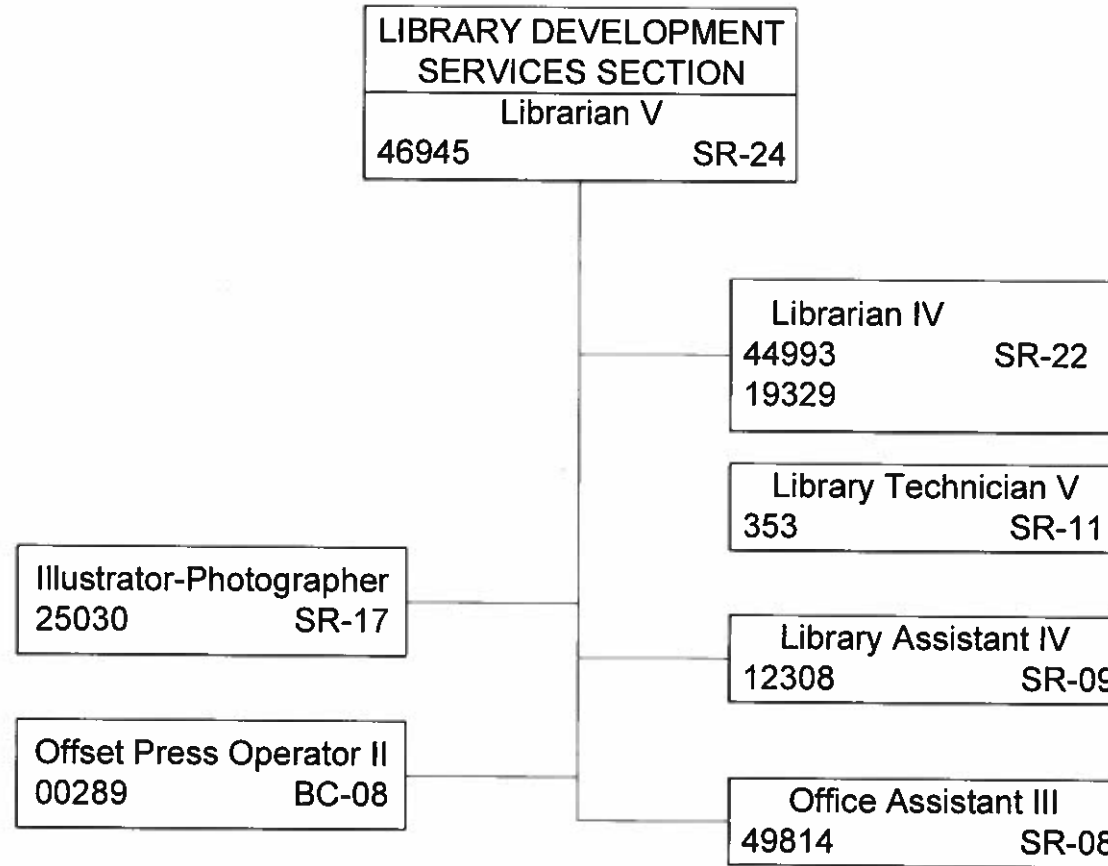

As of 6/30/20

  
Stacey A. Aldrich  
State Librarian

CHART V

STATE OF HAWAII  
DEPARTMENT OF EDUCATION  
HAWAII STATE PUBLIC LIBRARY SYSTEM  
POSITION ORGANIZATION CHART  
ADMINISTRATIVE SERVICES BRANCH

1/ Position to be redescribed  
2/ Position is responsible for labor relations area.

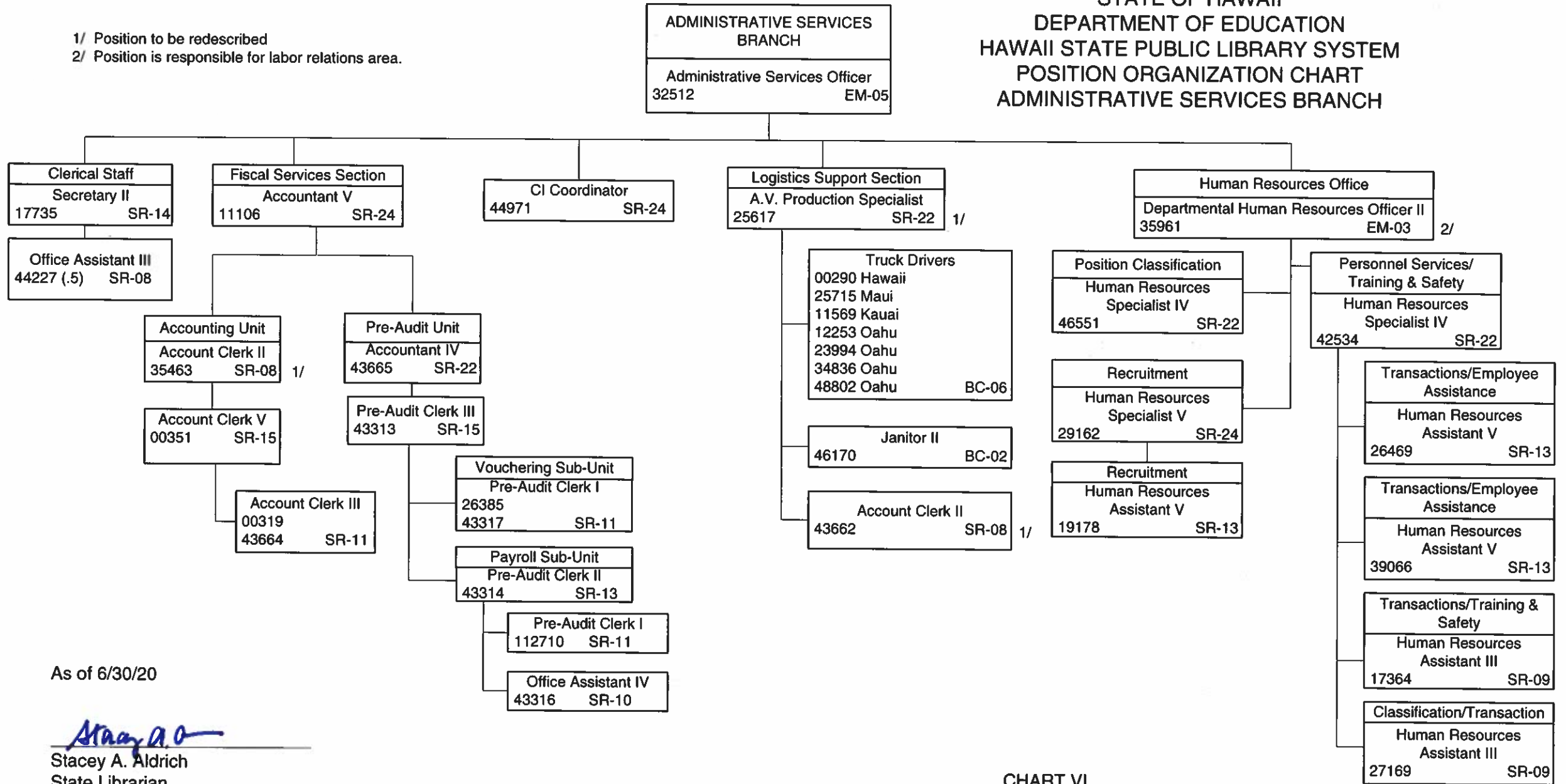

As of 6/30/20

*Stacey A. Aldrich*  
Stacey A. Aldrich  
State Librarian

CHART VI

STATE OF HAWAII  
DEPARTMENT OF EDUCATION  
HAWAII STATE PUBLIC LIBRARY SYSTEM  
ORGANIZATION CHART  
HAWAII STATE LIBRARY

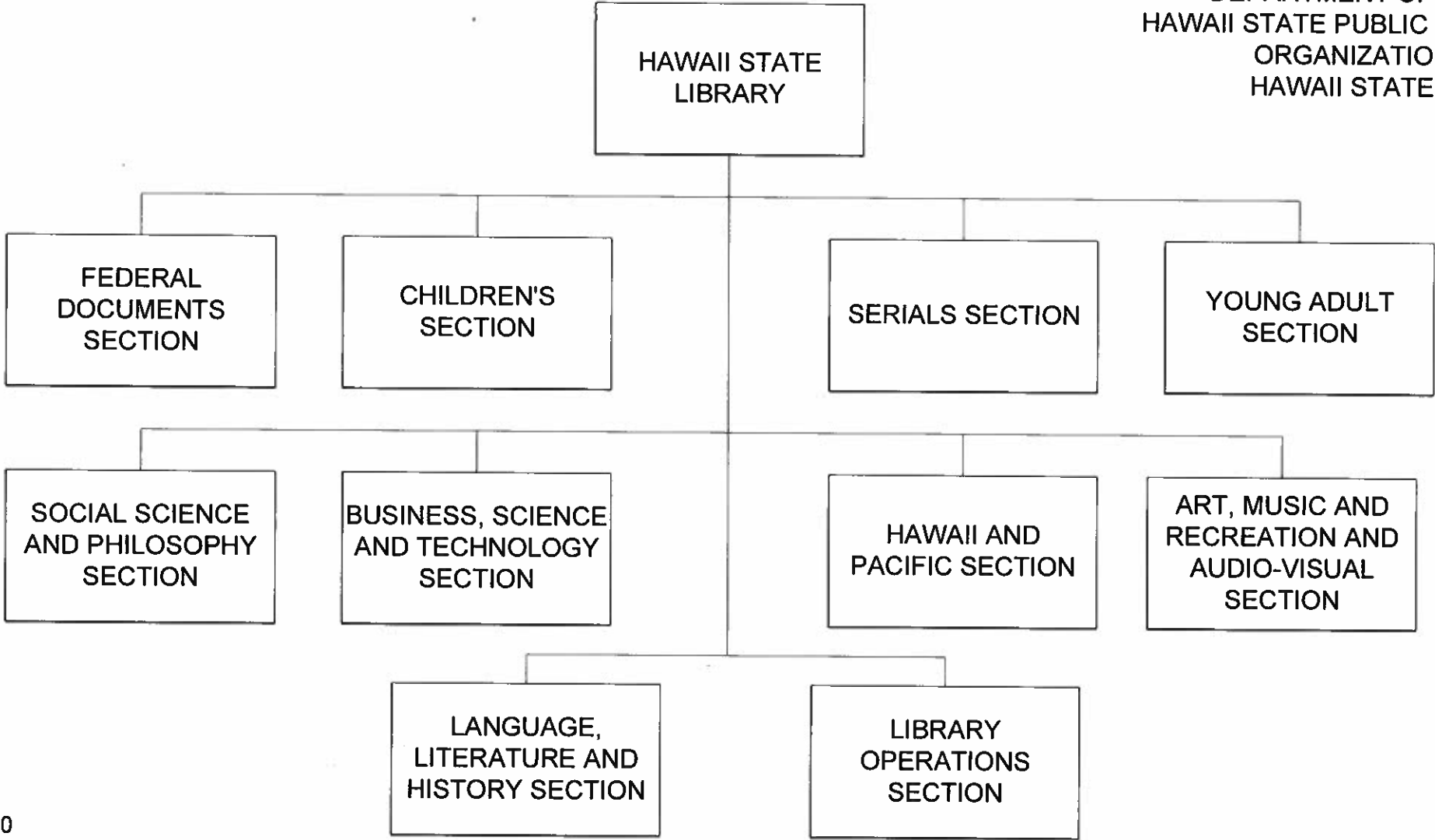

As of 6/30/20

  
Stacey A. Aldrich  
State Librarian

STATE OF HAWAII  
DEPARTMENT OF EDUCATION  
HAWAII STATE PUBLIC LIBRARY SYSTEM  
POSITION ORGANIZATION CHART  
HAWAII STATE LIBRARY

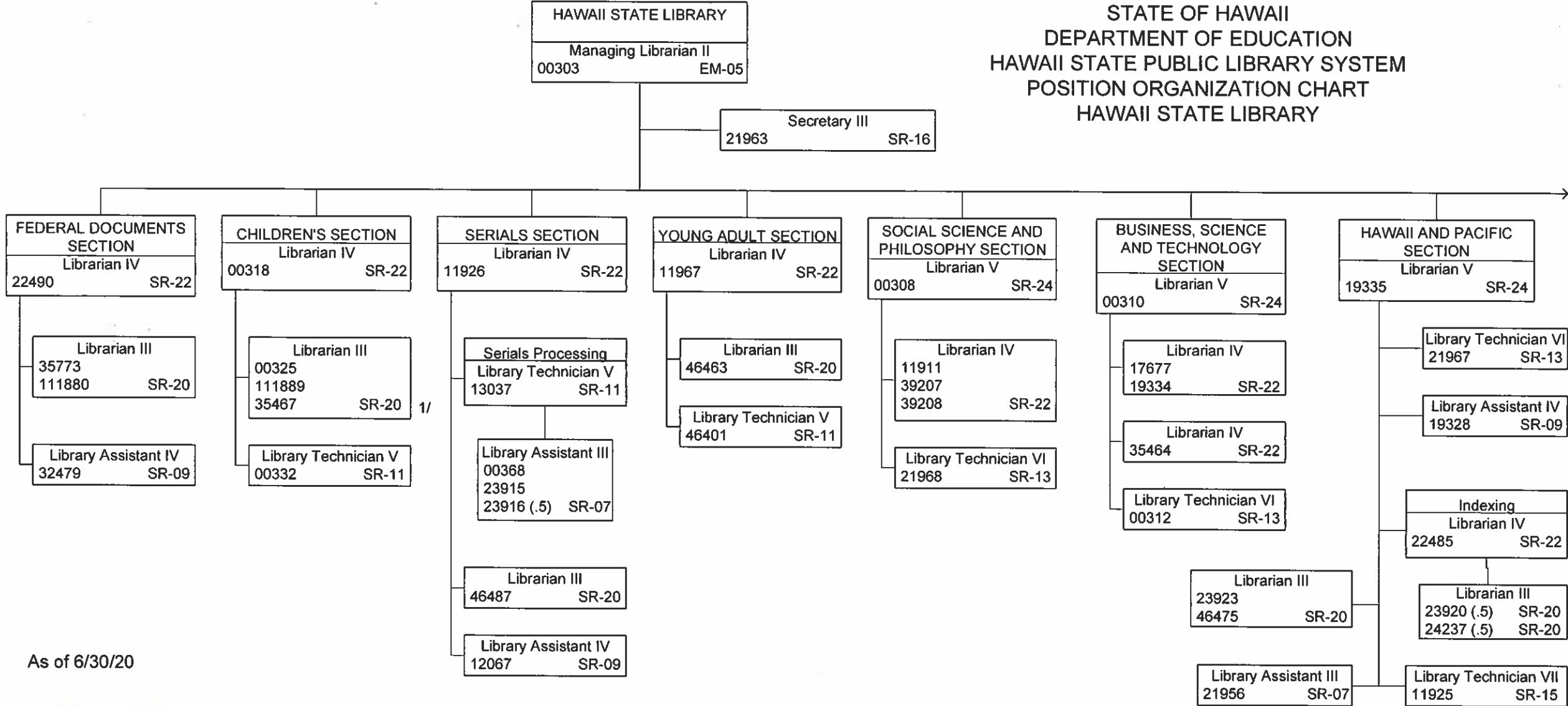

1/ Position shared with Young Adult Section

As of 6/30/20

*Stacey A. Aldrich*  
Stacey A. Aldrich  
State Librarian

STATE OF HAWAII  
 DEPARTMENT OF EDUCATION  
 HAWAII STATE PUBLIC LIBRARY SYSTEM  
 POSITION ORGANIZATION CHART  
 HAWAII STATE LIBRARY

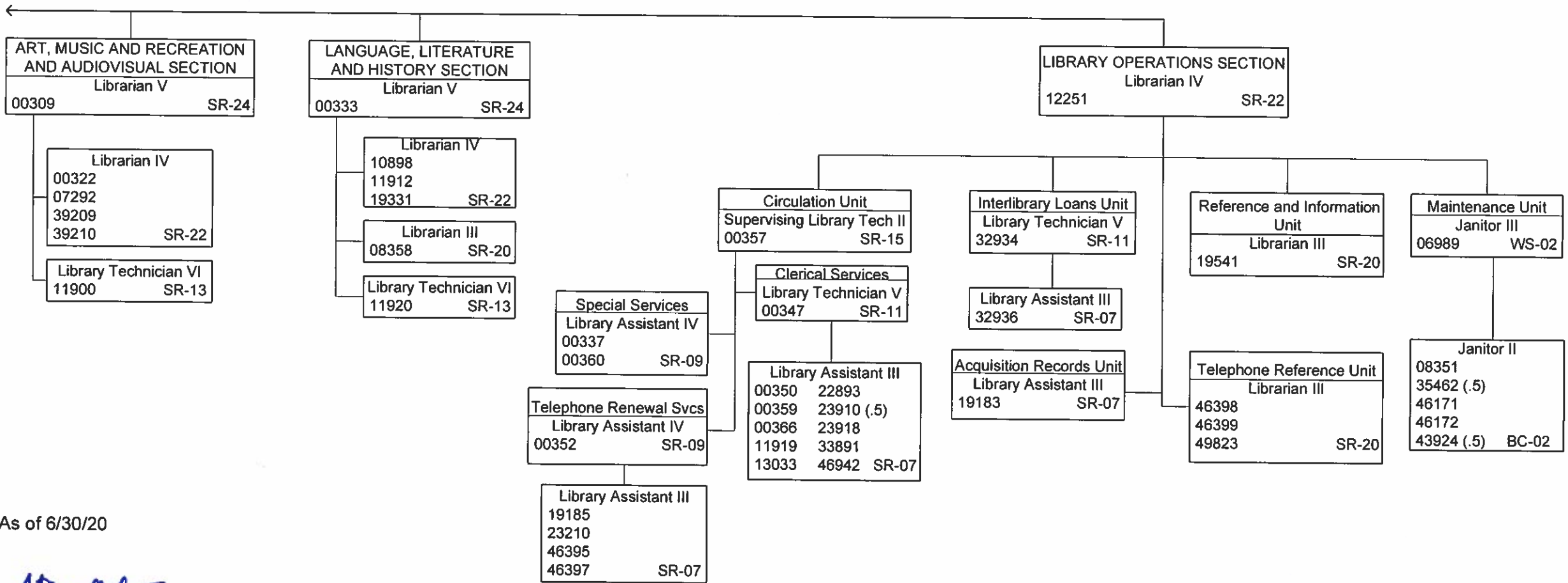

As of 6/30/20

*Stacey A. Aldrich*  
 Stacey A. Aldrich  
 State Librarian

CHART VII-B

STATE OF HAWAII  
 DEPARTMENT OF EDUCATION  
 HAWAII STATE PUBLIC LIBRARY SYSTEM  
 POSITION ORGANIZATION CHART  
 LIBRARY FOR THE BLIND AND  
 PRINT DISABLED

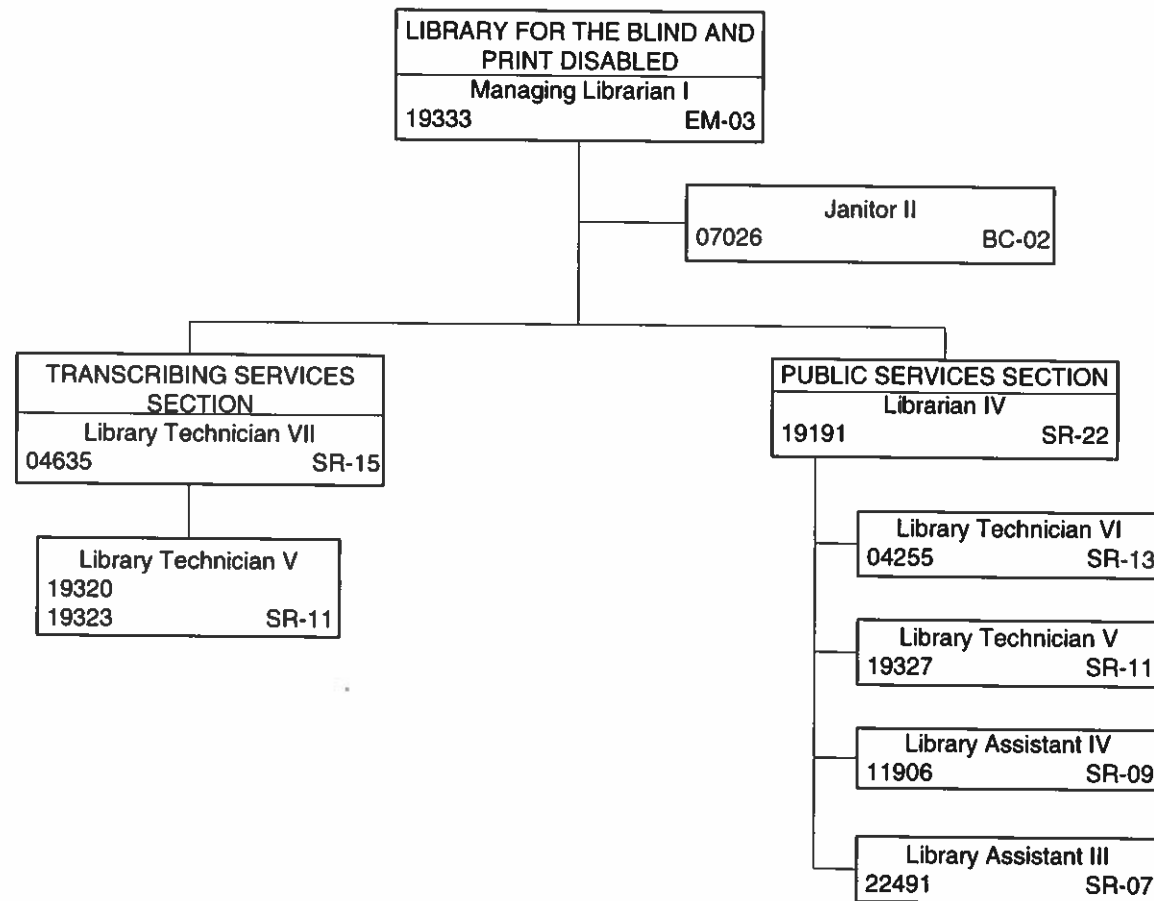

As of 6/30/20

  
 Stacey A. Aldrich  
 State Librarian

CHART VIII

STATE OF HAWAII  
DEPARTMENT OF EDUCATION  
HAWAII STATE PUBLIC LIBRARY SYSTEM  
ORGANIZATION CHART  
PUBLIC LIBRARIES BRANCH

PUBLIC LIBRARIES BRANCH  
Managing Librarian II  
49822 EM-05

Secretary III  
112250 SR-16

Librarian V  
44224 SR-24

Office Assistant IV  
32248 SR-10

1/ Position to be transferred and redescribed

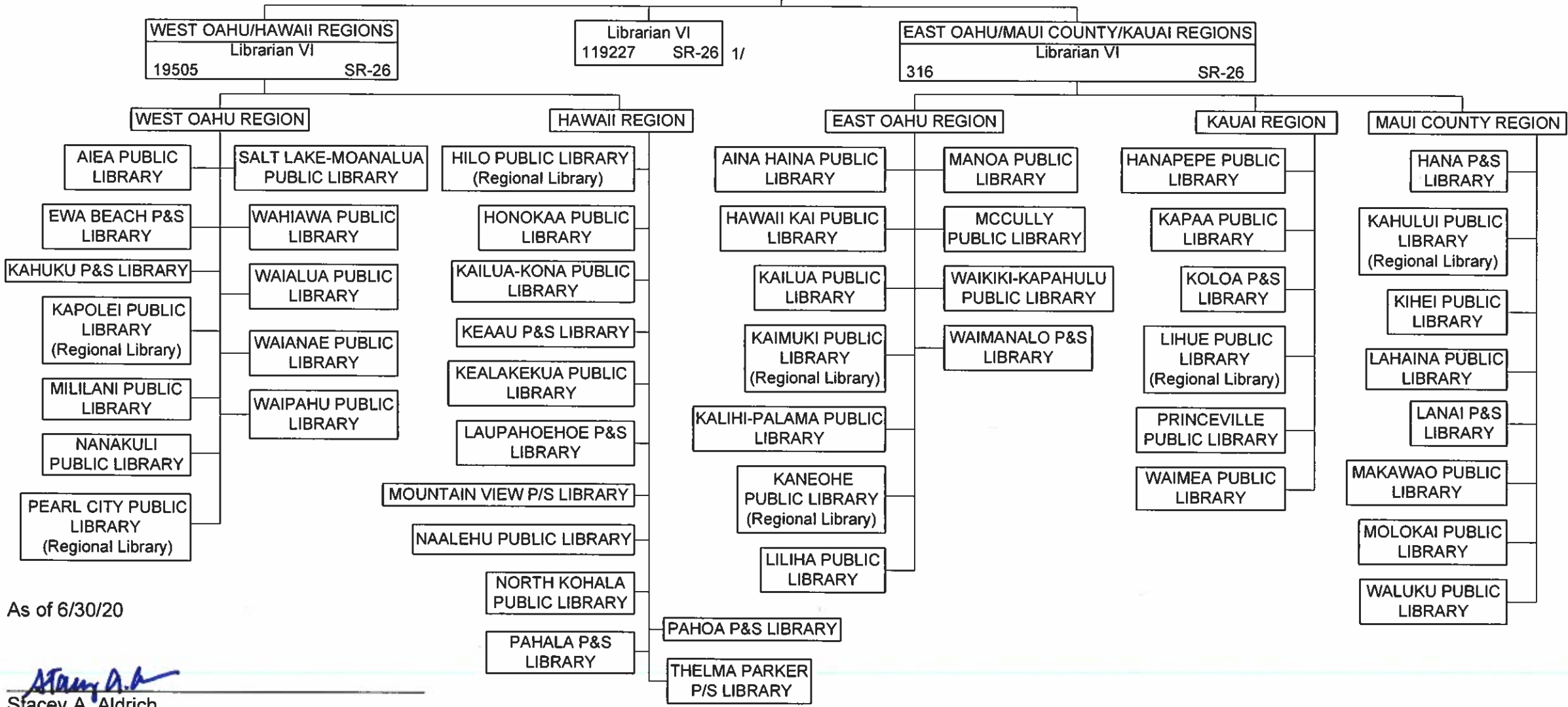

As of 6/30/20

*Stacey A. Aldrich*  
Stacey A. Aldrich  
State Librarian

CHART IX



1/ Reallocated to Librarian V, SR-24, for recruitment purposes eff. 7/1/16

WEST OAHU/HAWAII REGIONS  
Librarian VI  
19505 SR-26 1/

STATE OF HAWAII  
DEPARTMENT OF EDUCATION  
HAWAII STATE PUBLIC LIBRARY SYSTEM  
ORGANIZATION CHART  
PUBLIC LIBRARIES BRANCH  
WEST OAHU/HAWAII REGIONS

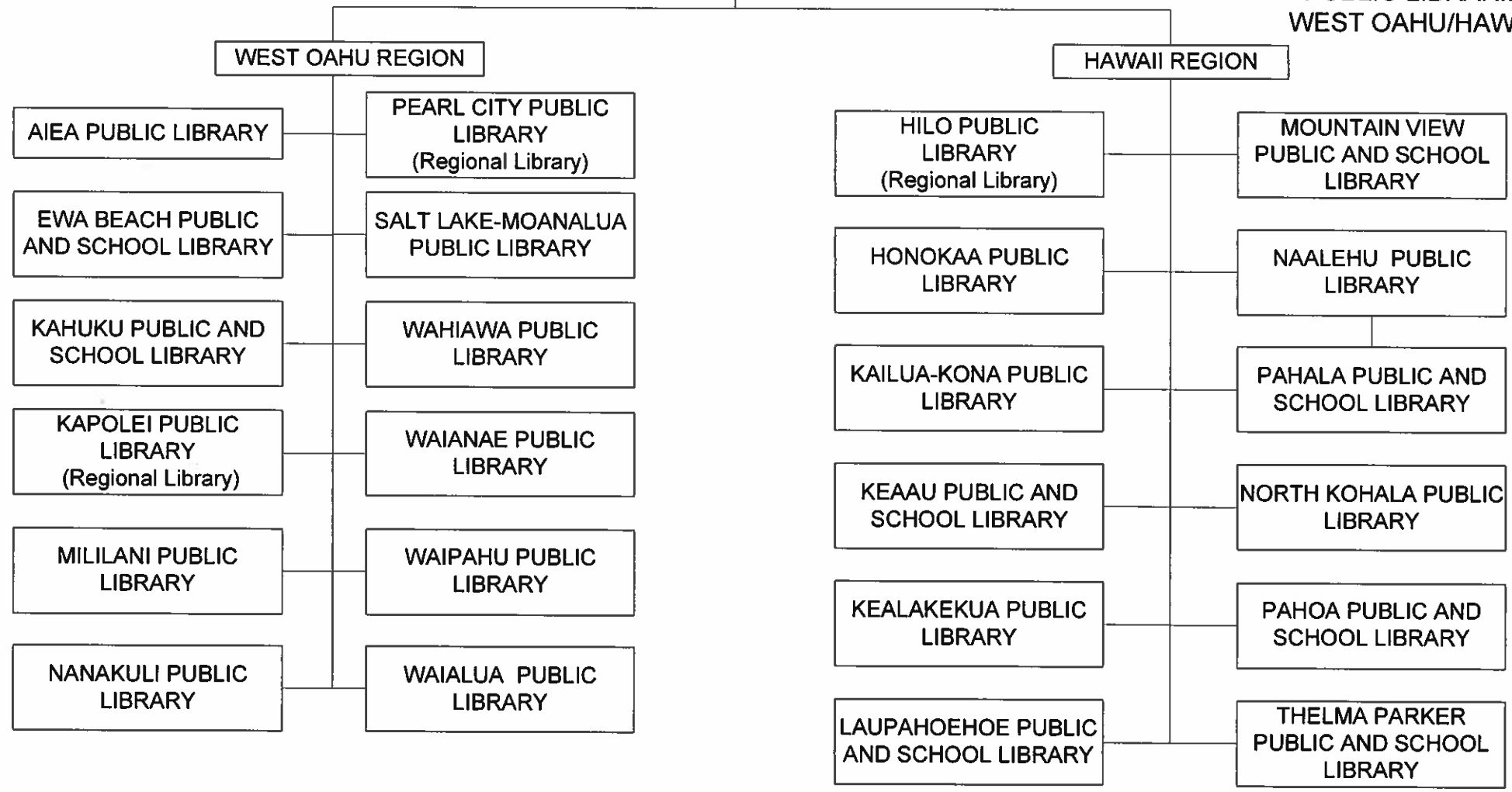

As of 6/30/20

  
Stacey A. Aldrich  
State Librarian

CHART IX-A

STATE OF HAWAII  
DEPARTMENT OF EDUCATION  
HAWAII STATE PUBLIC LIBRARY SYSTEM  
POSITION ORGANIZATION CHART  
PUBLIC LIBRARIES BRANCH  
WEST OAHU REGION

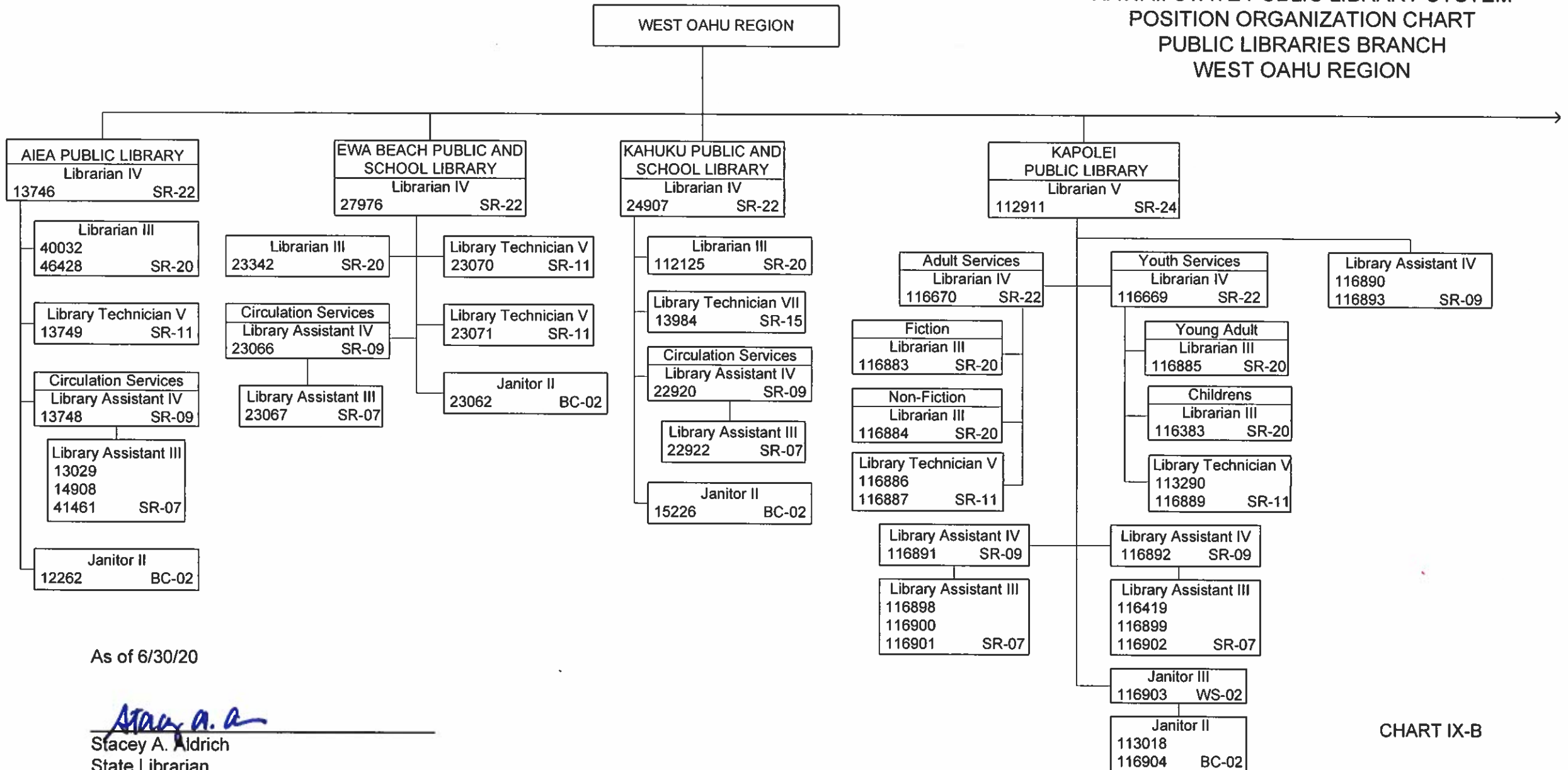

As of 6/30/20

*Stacey A. Aldrich*  
Stacey A. Aldrich  
State Librarian

CHART IX-B

STATE OF HAWAII  
DEPARTMENT OF EDUCATION  
HAWAII STATE PUBLIC LIBRARY SYSTEM  
POSITION ORGANIZATION CHART  
PUBLIC LIBRARIES BRANCH  
WEST OAHU REGION

1/ Pending establishment

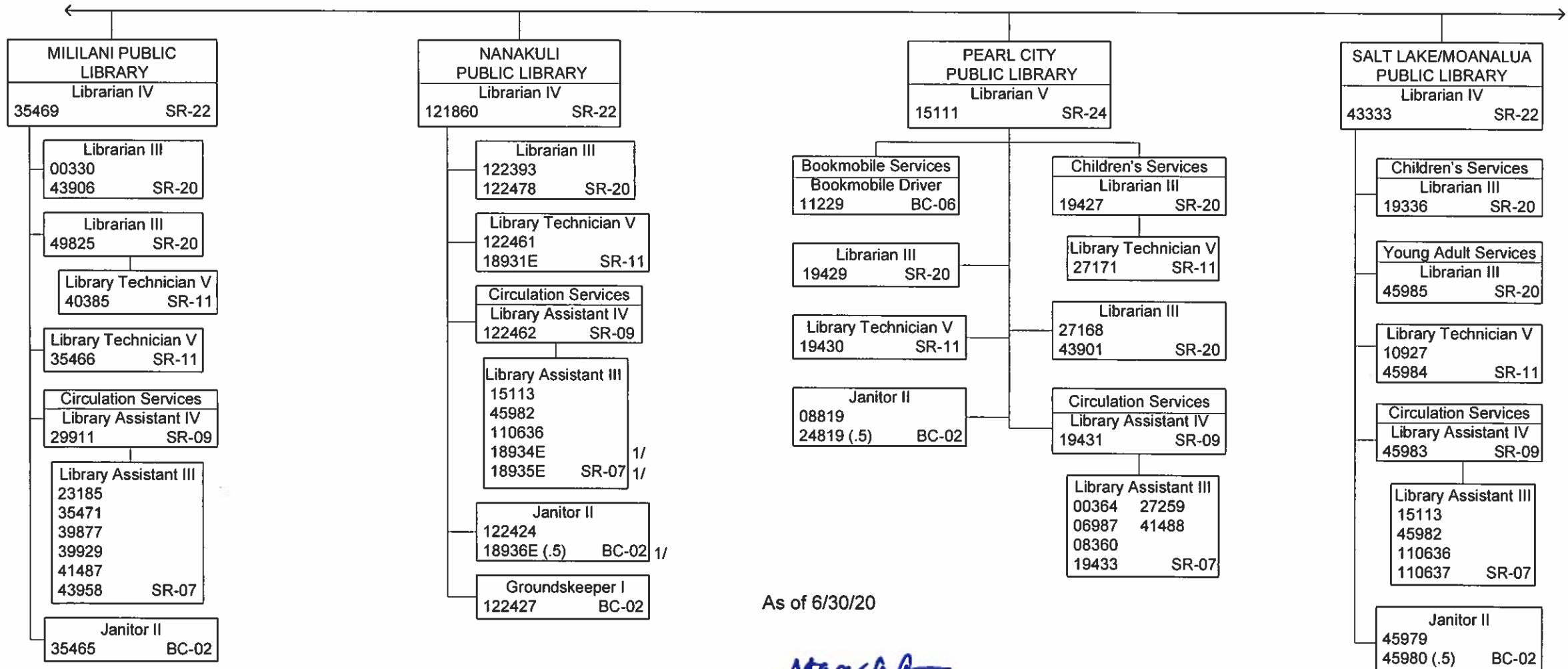

As of 6/30/20

*Stacey A. Aldrich*  
Stacey A. Aldrich  
State Librarian

CHART IX-C

STATE OF HAWAII  
 DEPARTMENT OF EDUCATION  
 HAWAII STATE PUBLIC LIBRARY SYSTEM  
 POSITION ORGANIZATION CHART  
 PUBLIC LIBRARIES BRANCH  
 WEST OAHU REGION

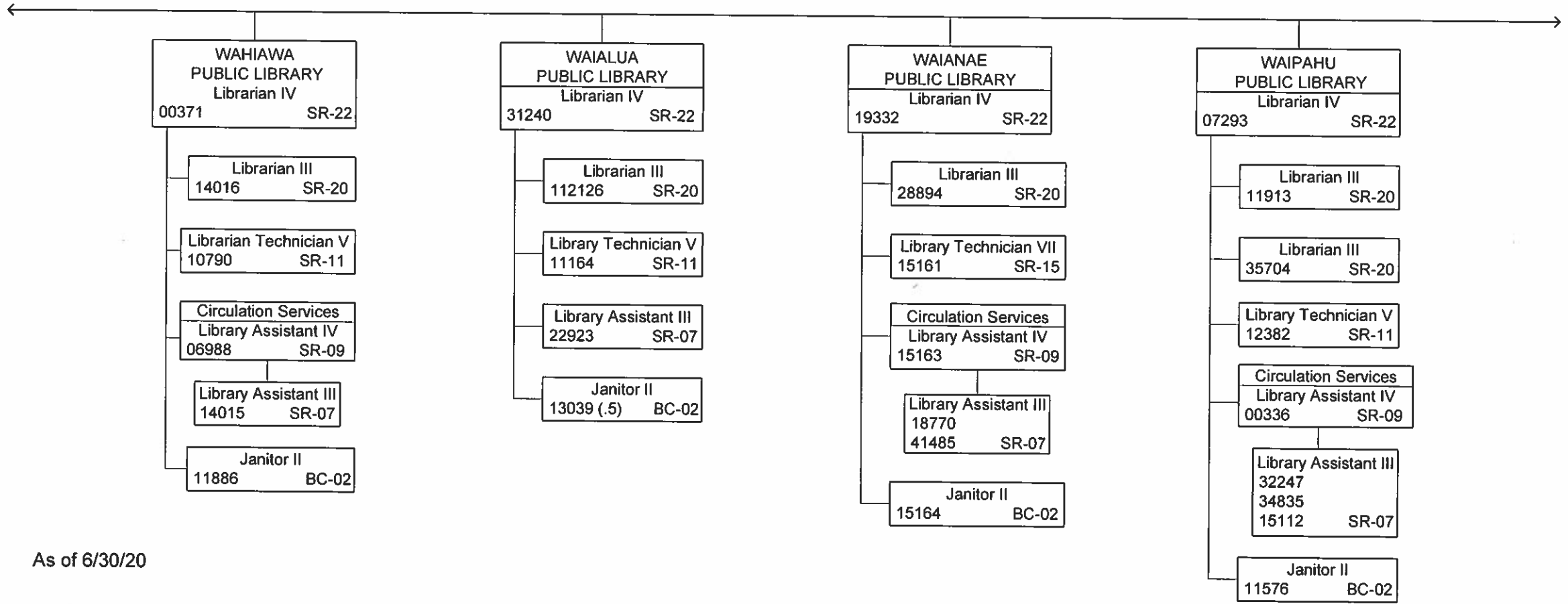

As of 6/30/20

*Stacey A. Aldrich*  
 \_\_\_\_\_  
 Stacey A. Aldrich  
 State Librarian

CHART IX-D

STATE OF HAWAII  
DEPARTMENT OF EDUCATION  
HAWAII STATE PUBLIC LIBRARY SYSTEM  
POSITION ORGANIZATION CHART  
PUBLIC LIBRARIES BRANCH  
HAWAII REGION

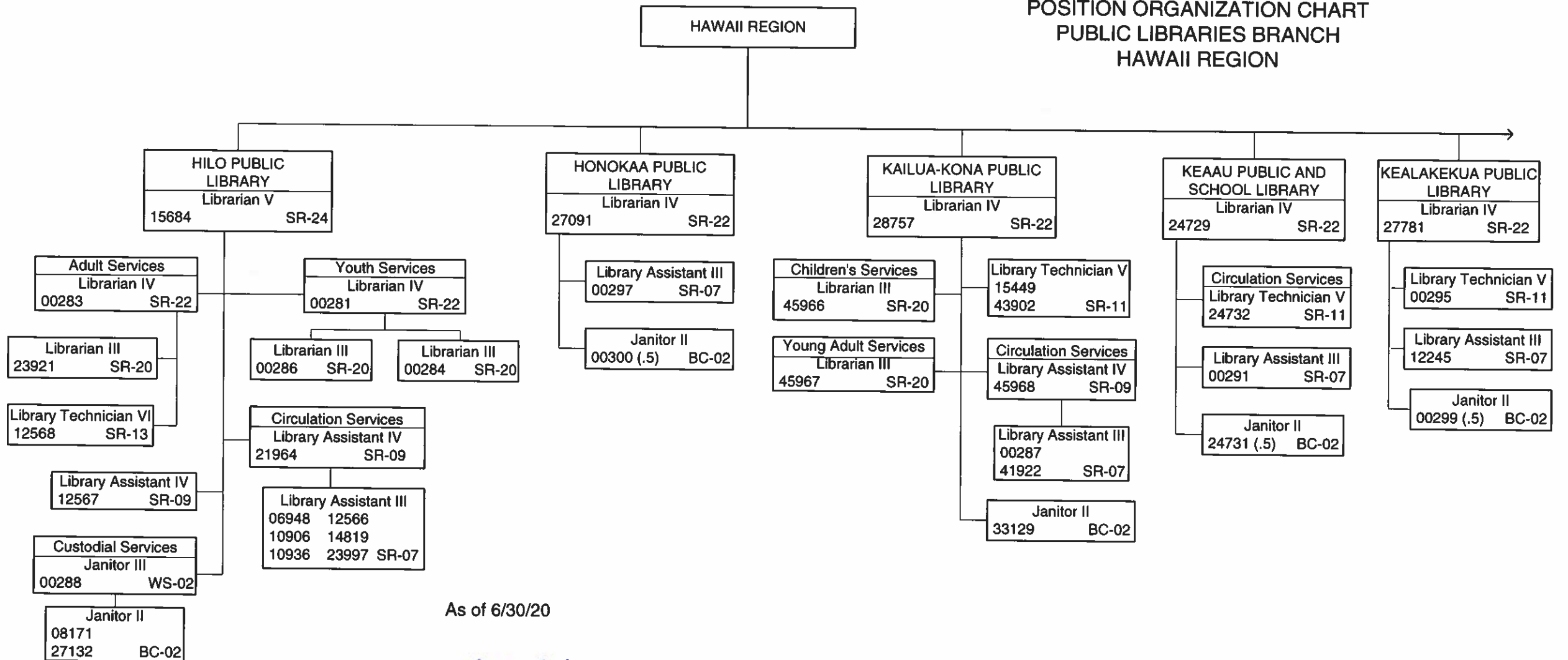

As of 6/30/20

*Stacey A. Aldrich*  
Stacey A. Aldrich  
State Librarian

CHART IX-E

STATE OF HAWAII  
 DEPARTMENT OF EDUCATION  
 HAWAII STATE PUBLIC LIBRARY SYSTEM  
 POSITION ORGANIZATION CHART  
 PUBLIC LIBRARIES BRANCH  
 HAWAII REGION

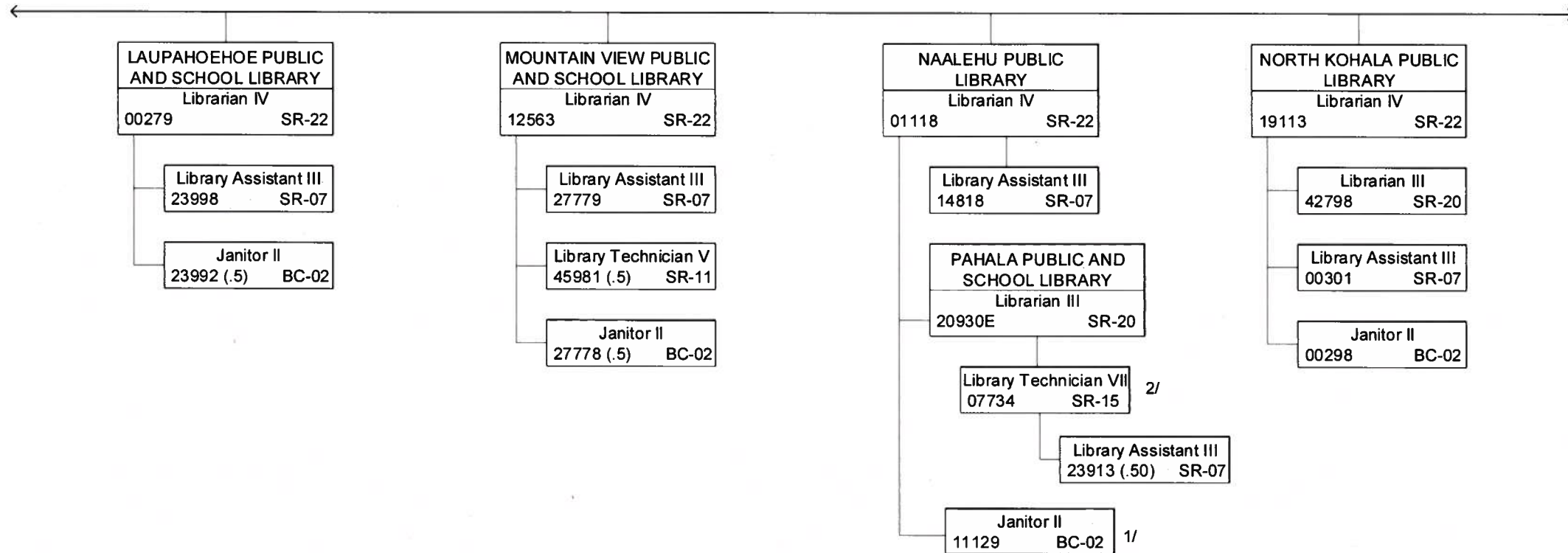

APPROVED

Stacey A. Aldrich      12/23/2000  
 State Librarian      Date

1/ Position physically located at Pahala but supervised by Pos. No. 1118, Librarian IV, located at Naalehu  
 2/ To Be Redescribed

CHART IX-F

STATE OF HAWAII  
 DEPARTMENT OF EDUCATION  
 HAWAII STATE PUBLIC LIBRARY SYSTEM  
 POSITION ORGANIZATION CHART  
 PUBLIC LIBRARIES BRANCH  
 HAWAII REGION

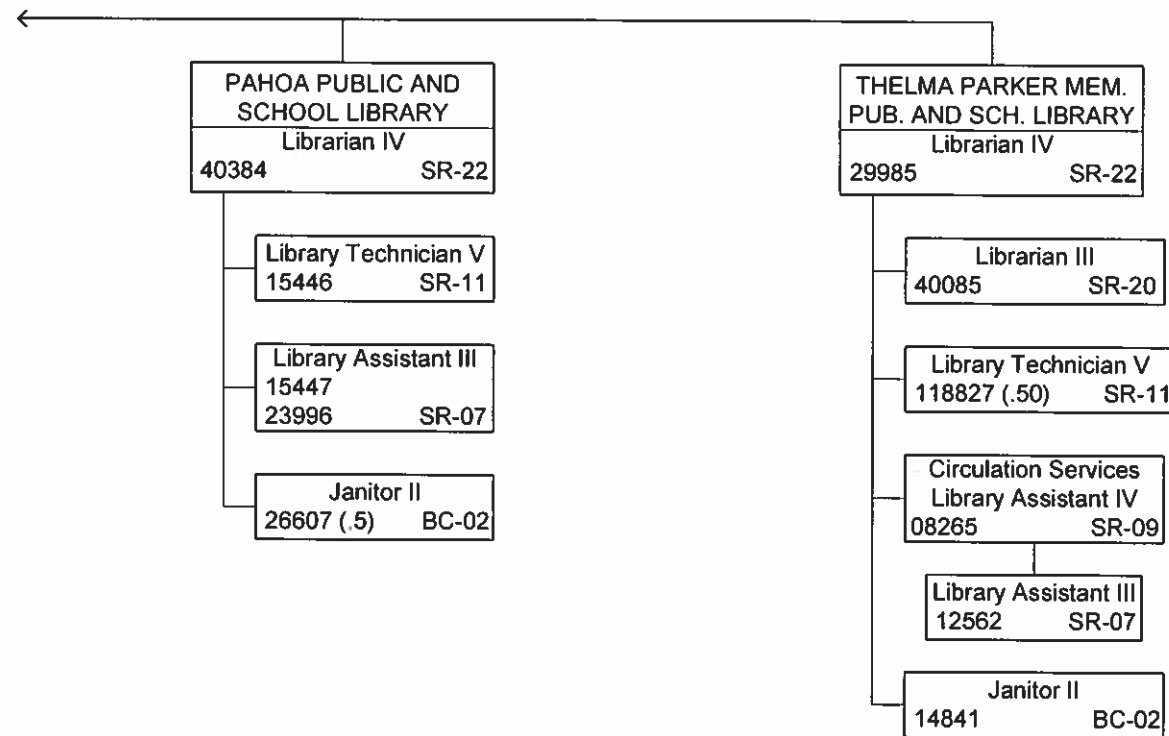

As of 6/30/20

  
 Stacey A. Aldrich  
 State Librarian

CHART IX-G

STATE OF HAWAII  
 DEPARTMENT OF EDUCATION  
 HAWAII STATE PUBLIC LIBRARY SYSTEM  
 ORGANIZATION CHART  
 PUBLIC LIBRARIES BRANCH  
 EAST OAHU/MAUI COUNTY/KAUAI REGIONS

EAST OAHU/MAUI COUNTY/KAUAI REGIONS  
 Librarian VI  
 00316 SR-26

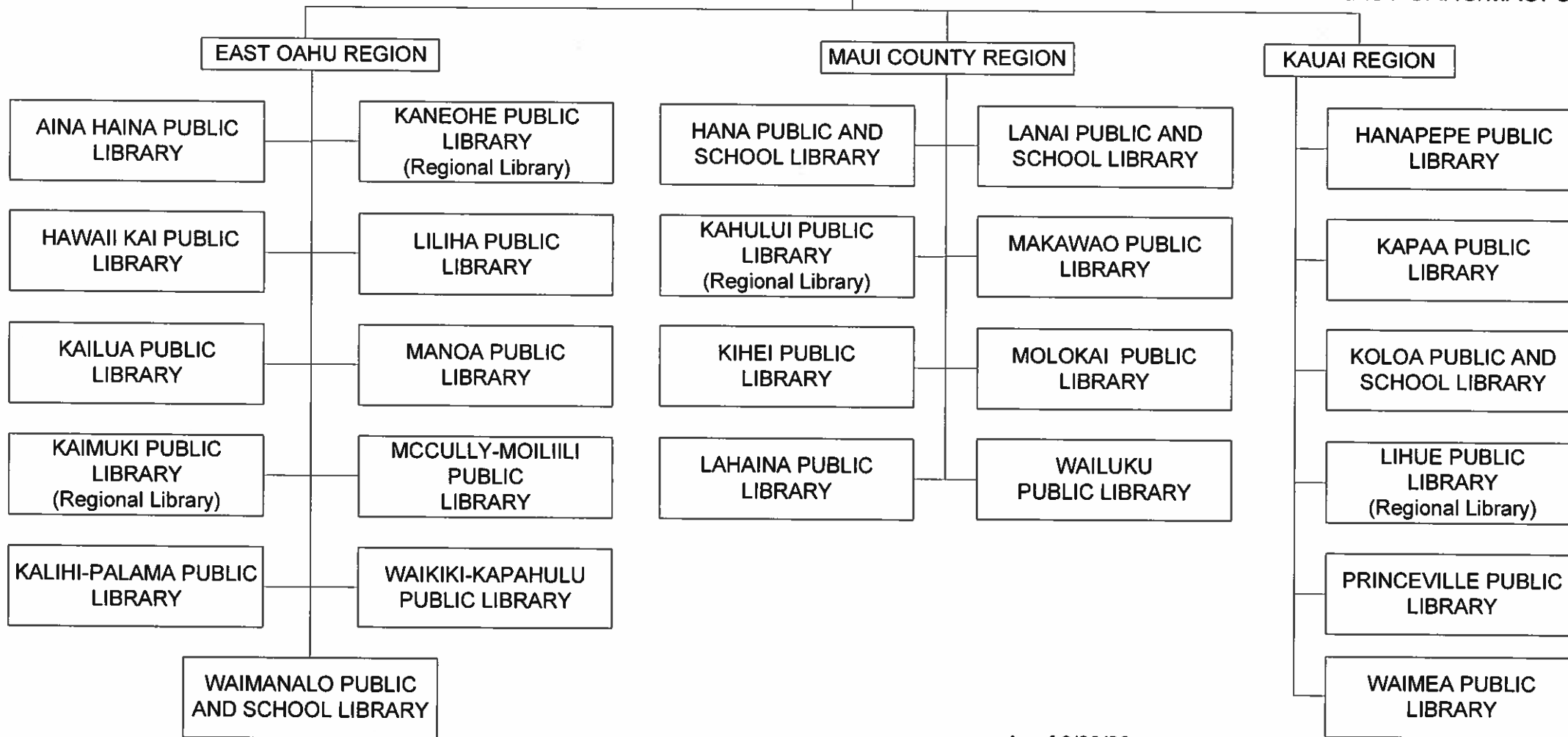

As of 6/30/20

CHART IX-H

*Stacey A. Aldrich*  
 Stacey A. Aldrich  
 State Librarian



STATE OF HAWAII  
DEPARTMENT OF EDUCATION  
HAWAII STATE PUBLIC LIBRARY SYSTEM  
POSITION ORGANIZATION CHART  
PUBLIC LIBRARIES BRANCH  
EAST OAHU REGION

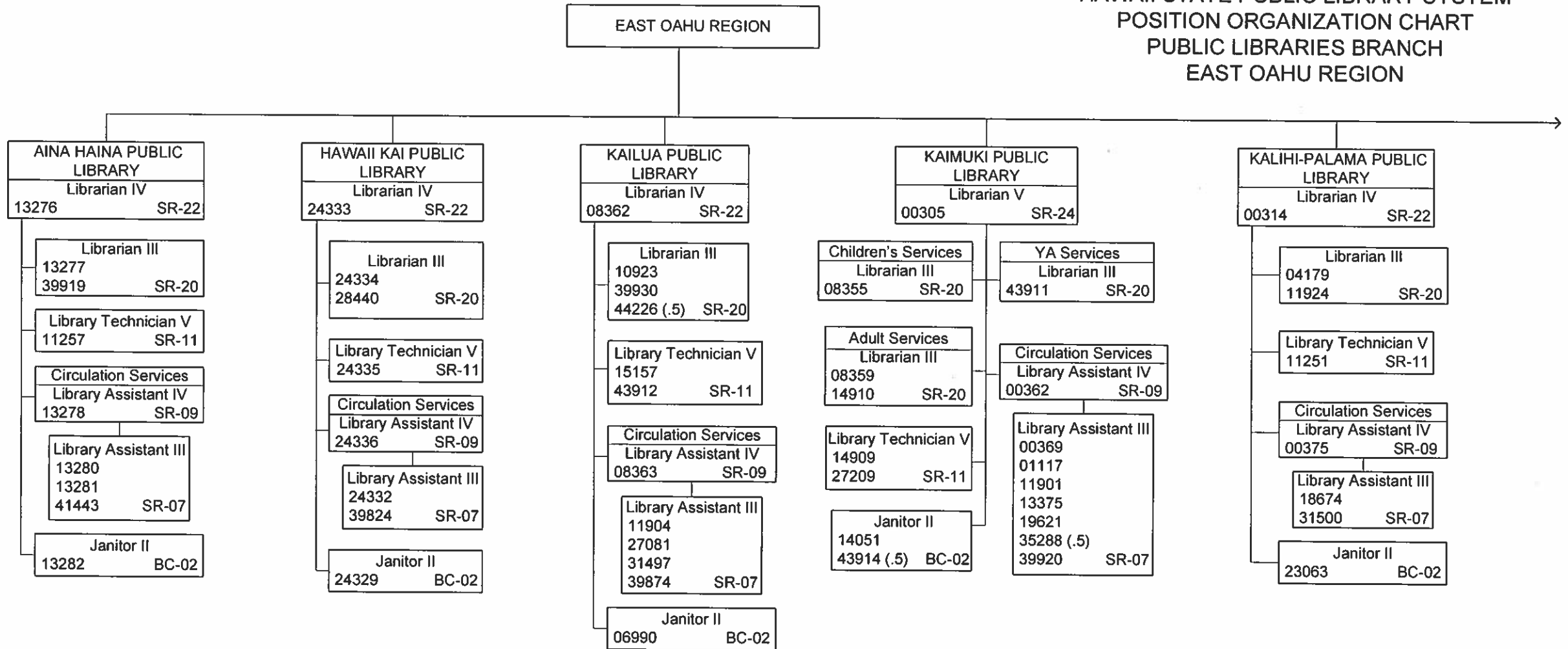

As of 6/30/20

*Stacey A. Aldrich*  
Stacey A. Aldrich  
State Librarian

CHART IX-I

STATE OF HAWAII  
DEPARTMENT OF EDUCATION  
HAWAII STATE PUBLIC LIBRARY SYSTEM  
POSITION ORGANIZATION CHART  
PUBLIC LIBRARIES BRANCH  
EAST OAHU REGION

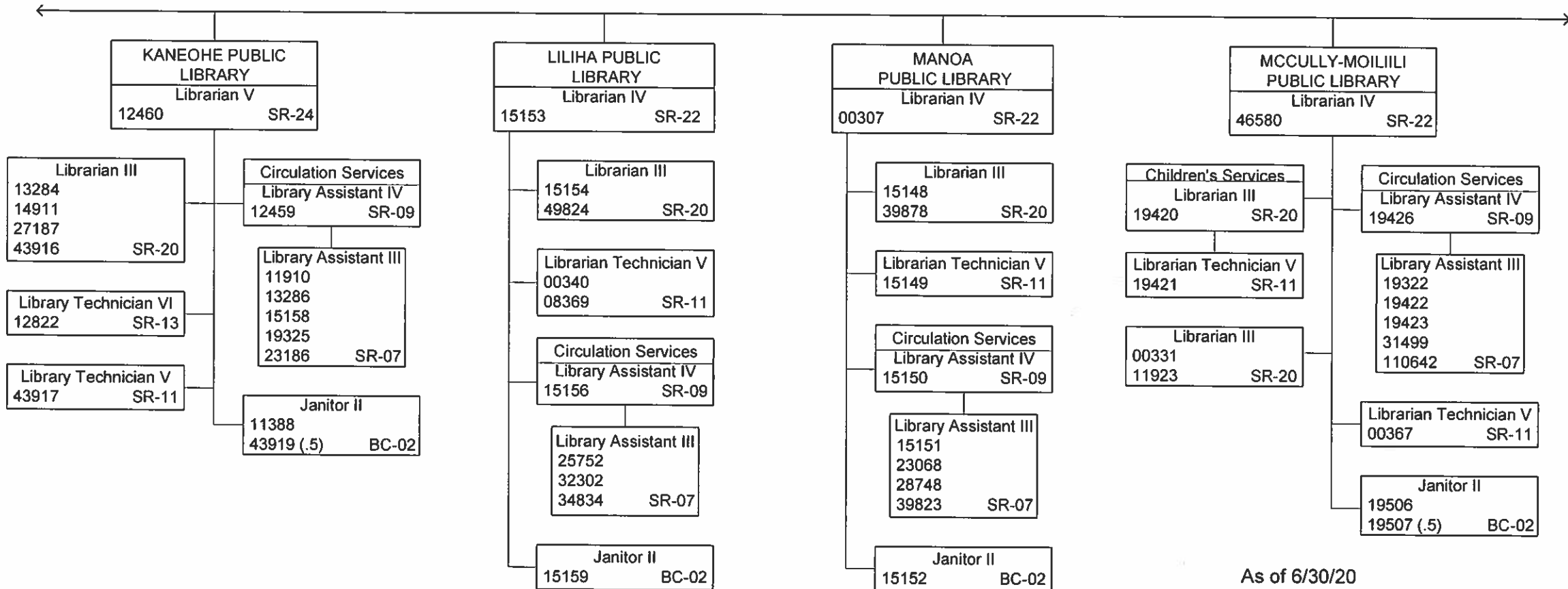

As of 6/30/20

CHART IX-J

*Stacey A. Aldrich*  
Stacey A. Aldrich  
State Librarian

STATE OF HAWAII  
 DEPARTMENT OF EDUCATION  
 HAWAII STATE PUBLIC LIBRARY SYSTEM  
 POSITION ORGANIZATION CHART  
 PUBLIC LIBRARIES BRANCH  
 EAST OAHU REGION

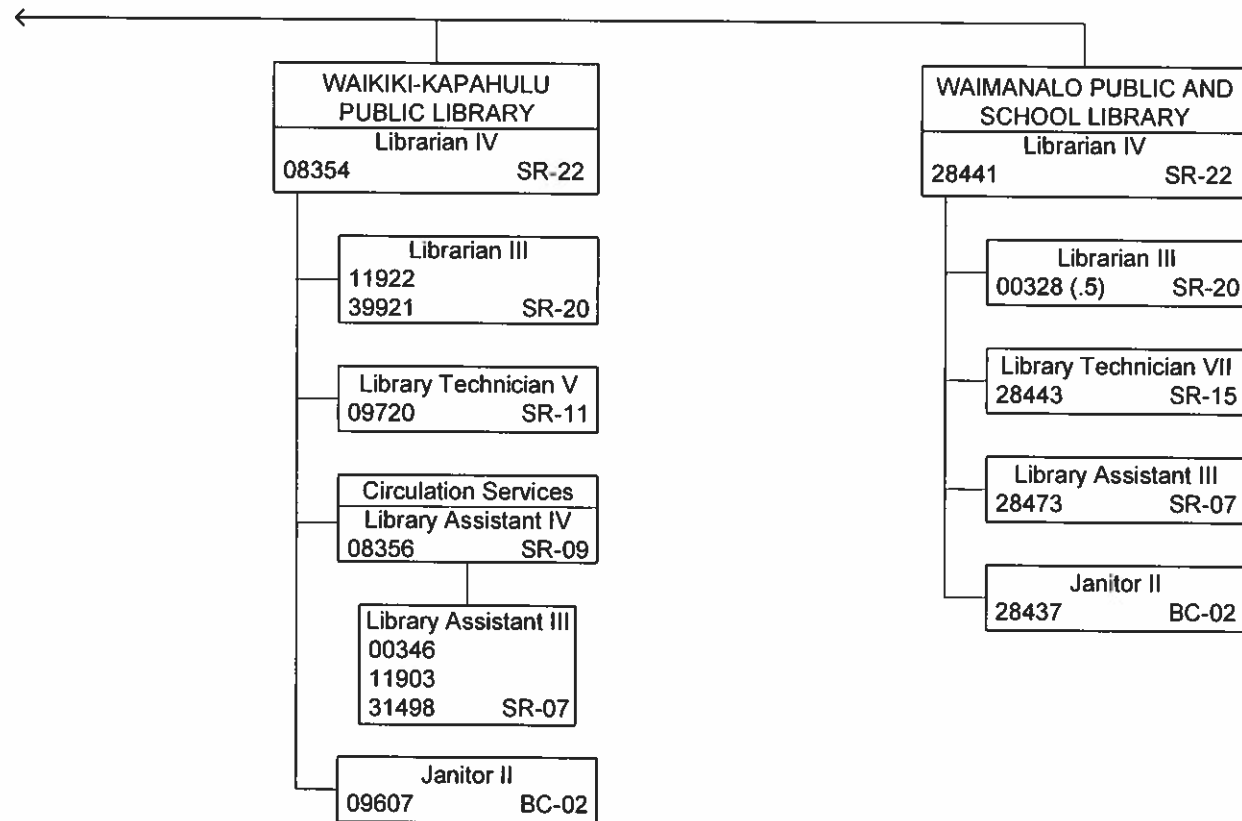

As of 6/30/20

*Stacey A. Aldrich*  
 \_\_\_\_\_  
 Stacey A. Aldrich  
 State Librarian

CHART IX-K

STATE OF HAWAII  
DEPARTMENT OF EDUCATION  
HAWAII STATE PUBLIC LIBRARY SYSTEM  
POSITION ORGANIZATION CHART  
PUBLIC LIBRARIES BRANCH  
MAUI COUNTY REGION

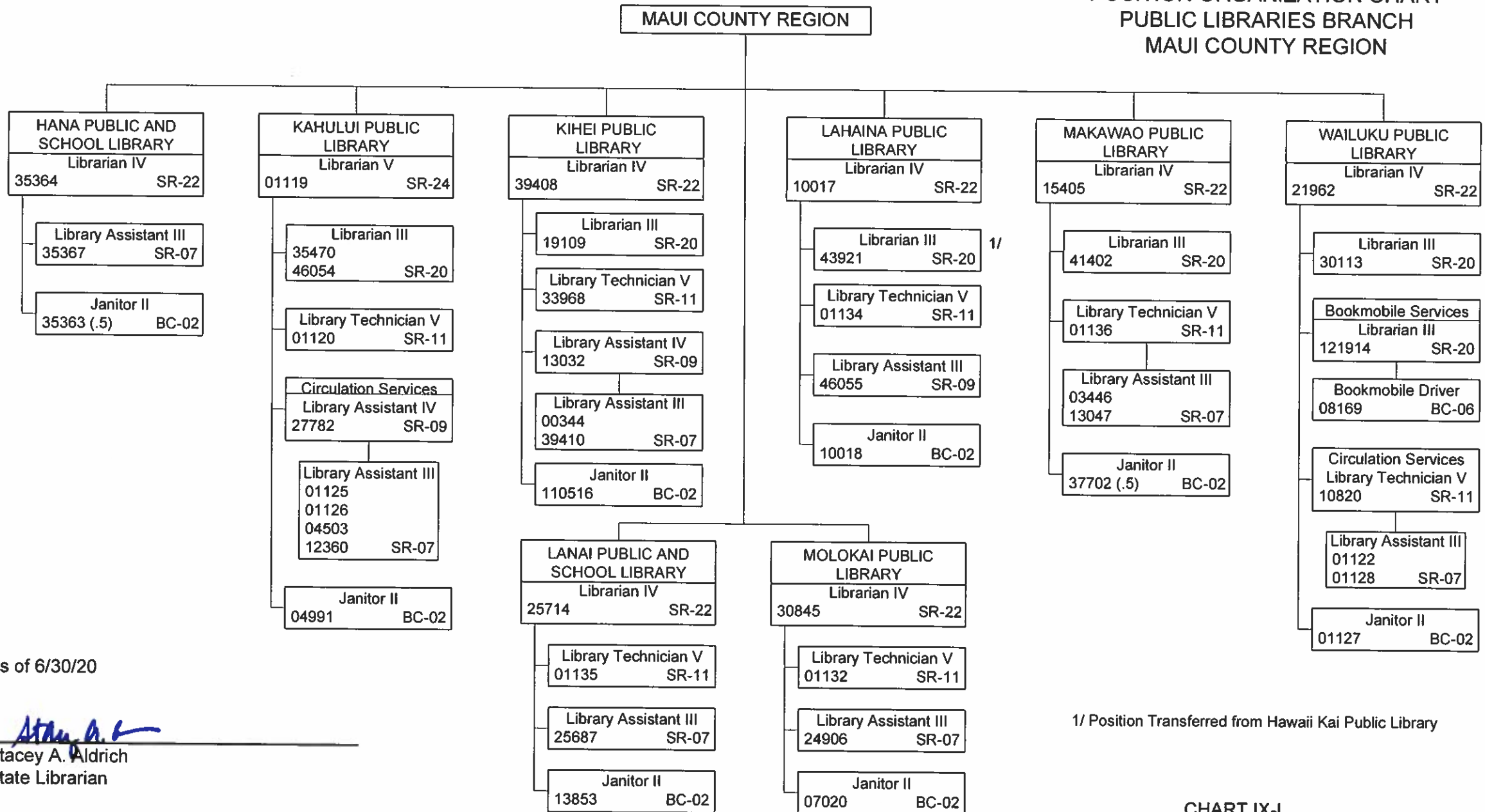

As of 6/30/20

  
Stacey A. Aldrich  
State Librarian

1/ Position Transferred from Hawaii Kai Public Library

CHART IX-L

STATE OF HAWAII  
 DEPARTMENT OF EDUCATION  
 HAWAII STATE PUBLIC LIBRARY SYSTEM  
 POSITION ORGANIZATION CHART  
 PUBLIC LIBRARIES BRANCH  
 KAUAI REGION

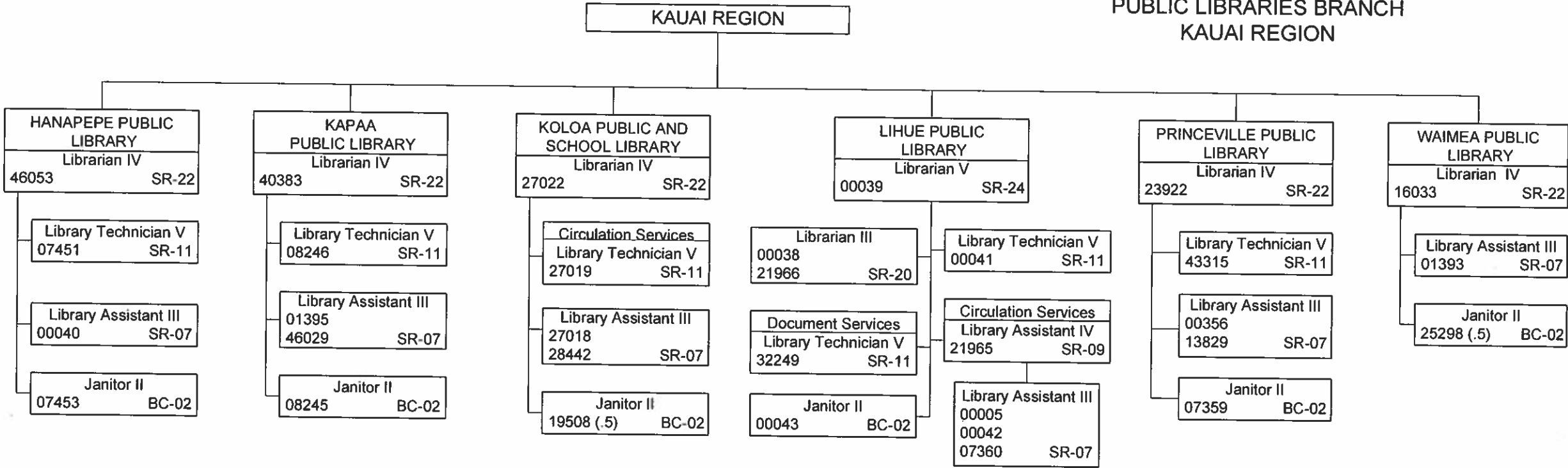

As of 6/30/20

  
 Stacey A. Aldrich  
 State Librarian

CHART IX-M

DEPARTMENT OF EDUCATION  
HAWAII STATE PUBLIC LIBRARY SYSTEM

FUNCTIONAL STATEMENTS  
(As of June 30, 2020)

TABLE OF CONTENTS

	PAGE
OFFICE OF THE STATE LIBRARIAN .....	1
SPECIAL ASSISTANT TO THE STATE LIBRARIAN.....	2
TECHNICAL SERVICES SECTION .....	3
ELECTRONIC SUPPORT SERVICES SECTION .....	5
LIBRARY DEVELOPMENT SERVICES SECTION .....	6
ADMINISTRATIVE SERVICES BRANCH .....	7
Logistics Support Services.....	9
Human Resources Office.....	10
HAWAII STATE LIBRARY .....	11
LIBRARY FOR THE BLIND AND PRINT DISABLED .....	18
DISTRICT OFFICES .....	19

## OFFICE OF THE STATE LIBRARIAN

With oversight by the Board of Education, the State Librarian plans, directs, measures, evaluates, and reports to the Board, the Governor, the Legislature, and the public about library services, collections, and programs which fulfill the mission of the Hawaii State Public Library System (HSPLS).

- Represents HSPLS to the Board of Education, the Governor, the Legislature, other State agencies, the Congressional delegation, professional organization, community groups, and the public.
- Develops and recommends policies for Board approval and implements and evaluates policies.
- Initiates long-range statewide strategic planning and needs assessment studies; develops goals, objectives, standards, and evaluation criteria; and oversees activities to achieve system objectives.
- Establishes a coherent, effective organizational structure and lines of authority.
- Develops an administrative and support services team, which represents all functions within HSPLS: the Hawaii State Library and the Library for the Blind and Physically Handicapped, community libraries, and their support units including administrative services, human resources, electronic support, technical services, and library development.
- Facilitates effective communication and working relationships throughout the organization.
- Promotes a commitment to fair and consistent services throughout the library system for all customers by overseeing the development and documentation of integrated policies, guidelines, and procedures.
- Pursues State and Federal funding, grants, and donations to maximize HSPLS' ability to provide an appropriate and innovative array of collections, services, and programs to meet community needs.
- Develops a program-based, needs-driven budget for recommendation to the Board. Presents testimony and provides background information and reports during the legislative session.
- Mentors library staff by providing encouragement, guidance, and training opportunities to increase knowledge, skills, and performance and to prepare staff to assume increasing levels of responsibility and leadership.
- Networks with DHRD, the University of Hawaii's Library and Information Science program, and other government, professional, and community organizations to attract potential applicants and make them aware of employment opportunities within HSPLS.
- Monitors customer expectations as well as service methods and best practices in both the library and commercial fields.
- Initiates new technologies and practices to improve services and collections.
- Promotes a culture of continuous improvement and innovation.

## SPECIAL ASSISTANT TO THE STATE LIBRARIAN

The Special Assistant to the State Librarian provides support for the Office of the State Librarian by working with the State Librarian, library administrators and staff to implement Hawaii State Public Library System (HSPLS) program objectives.

- Participates in the planning, organizing, and administration of the HSPLS' programs and services.
- Confers with other administrative team members and program administrators to resolve problems, clarify system goals, objectives, priorities, and responsibilities, and implement initiatives approved by the State Librarian.
- Serves as a liaison with the Board of Education, Legislature, and other groups on behalf of HSPLS as necessary.



## TECHNICAL SERVICES SECTION (TSS)

The Technical Services Section orders, catalogs, and processes materials for Hawaii State Public Library System (HSPLS) libraries and recommends effective acquisitions and processing procedures for front-line staff. Through its national standards-based cataloging operations, TSS creates and maintains the bibliographic records in HSPLS' online inventory of library materials. TSS works with administrators, the public service staff, and the Electronic Services Support Section (ESSS) staff to maximize the union catalog's reliability and usefulness in accessing HSPLS' physical and digital collections.

### Acquisitions and Processing

- Recommends statewide policies, procedures, and practices for the acquisition and processing of materials.
- Recommends efficient and effective workflow methods relating to acquisitions and processing by front-line library staff.
- Notifies/distributes vendor catalogs and other promotional materials to libraries.
- Coordinates and compiles title recommendations from Hawaii State Library (HSL) subject specialists and selection committees into consolidated order lists, which are distributed in spreadsheet form to HSPLS libraries.
- Orders library materials selected and sent to TSS by HSPLS libraries.
- Coordinates order/receipt accounting with the Administrative Services Branch (ASB) for cost center accounting and purchase order/voucher production.
- Prepares and distributes status reports to HSPLS libraries about their orders and receipts.
- Serves as a liaison in resolving vendor problems between vendors and individual libraries. Files claims, receives credits, and verifies vendor statements and invoices.
- Evaluates vendor performance, prices, discounts, delivery times, and service quality.
- Processes and distributes centrally purchased and received materials.
- Processes centrally purchased library materials that are physically received and cataloged at TSS, including linking, labeling, stripping, stamping, covering, sorting and packing for delivery and mail.
- Develops written procedures and conducts training sessions for front-line staff about ordering and processing requirements. Instructs and advises staff about procedures on an on-going basis.
- Works with the Electronic Services Support Section (ESSS) to attain optimum performance of library automated systems related to acquisitions and processing
- Process HSPLS libraries' individual orders for library materials following the same procedures used for ordering library materials from the consolidated order list.
- Processes invoices for payment by matching the packing slips received at the libraries with the invoices, checking for discrepancies in titles, quantities, and pricing of library materials ordered and received.
- Reconciles and validates the monthly purchase card charges using the appropriate packing slip and invoice for each charge, requesting invoices as necessary, and paying invoices that are received, but not charged.

### Cataloging and Classification:

- Recommends statewide cataloging and classification policies and practices based on national standards .
- Provides centralize cataloging of library materials in print, non-print and electronic formats for all libraries in HSPLS. Creates and maintains bibliographic records and authority files.
- Provides classification and other identification for all library materials.
- Researches and corrects reported errors in the online catalog.
- Conducts training sessions and gives presentations on catalog and authority control requirements to libraries. Alerts the field about classification changes.
- Maintains the integrity of the bibliographic database.

### Cataloging and Classification (continued)

- Works with ESSS and vendors to resolve problems with automated library systems related to cataloging, database maintenance, and the public catalog.
- Participates in system discussions about new formats, technology, and collections and shares technical services expertise and recommendations.

- Monitors new developments, technologies, and best practices in the technical services field.
- Provides consultative services to HSPLS libraries on collection development and evaluation.

Other

- Oversees the common facility operations and maintenance requirements of all the support offices at the Salt Lake facility.
- Coordinates the receipt and distribution of materials donated to HSPLS, including cataloging and processing as needed.

## ELECTRONIC SERVICES SUPPORT SECTION (ESSS)

- Provides overall design, implementation, research and development of infrastructure and peripheral technological support for library services support offices.
- Provides information technology support to all HSPLS staff during all open hours of libraries and departments. Provides limited emergency support and services during off-hours.
- Provides tier 2 technical support to customers to assist in accessing HSPLS services. (Tier 1 is Telephone Reference & Information)
- Advises HSPLS core administrators of information technology changes, needs, assessments and conducts a regular dialogue with administration to ensure that operations and technology design align with the requirements and needs of HSPLS.
- Develops specifications for equipment and software to support libraries and departments.
- Provides hardware and software maintenance, upgrade and repair services for libraries and departments.
- Provides scheduled preventive maintenance services.
- Provides training and retraining on the library's electronic systems.
- Works with vendors and suppliers to provide timely, cost-effective services and resolution of problems.
- Administrates server systems (virtual and physical) and network connections.
- Monitors system activity and performance, reporting and adjusting as necessary to provide timely, economical services to staff and patrons.
- Coordinates system implementations with other State agencies; implements State-mandated IT directives.
- Advises and executes technical implementation of new services selected by Administration.
- Manages the HSPLS Debt Collection service.
- Maintains HSPLS notification system, including electronic mail notifications.
- Fulfills LSTA automation-related federal program reporting requirements.
- Scans juvenile applications for all locations, stores them digitally on servers and retrieves them when staff requests a copy.

### Administrative services:

- Provides oversight of Section functions; prioritizes work; ensures adherence to scheduled events such as preventive maintenance, system upgrades, etc.
- Works with HSPLS administration to integrate new technologies and upgrades into system services.
- Prepares and defends Section budget request.
- Coordinates purchase/upgrade of services, hardware and software throughout HSPLS to provide consistency of access and ease of repair/upkeep.
- Provides all personnel services for the Section, including but not limited to, hiring, training, evaluation, discipline, prioritizing of work, and scheduling.

### Information Technology Specialists, Automation Technicians, Library Technician and Trainer

- Trains/retrains staff on all systems as current and at every upgrade/change.
- Logs all problem calls, responds immediately or as appropriate; communicates as necessary with all libraries/departments on system problems.
- Maintains intranet and learning corner sites where all technical documentation and resources reside.
- Monitors automated system operation; installs upgrades and fixes as required.
- Sets up all system administration activities to run at optimum times. Monitors all processes for problems, and creates backups at appropriate times.
- Monitors telecommunications network and works with provider to maintain maximum up time.
- Keeps current with changes/upgrades to telecommunications technologies.
- Provides installation, initial training, and repair service for all PCs telecommunication and peripheral equipment for libraries and departments.
- Purchase, install, and maintain telephone equipment.
- Maintains inventory of electronic equipment for HSPLS.
- Install and maintain theft loss systems.

## LIBRARY DEVELOPMENT SERVICES SECTION (LDSS)

- Plans, organizes, coordinates, seeks funding for, and evaluates library programs for the Hawaii State Public Library System (HSPLS).
- Works with corporate and nonprofit partners to sponsor joint programs and displays.
- Establishes and maintains a statewide database of programs and performer evaluations.
- Provides publicity and promotional support with media contacts, and photography and video-recording for selected events and assigned projects.
- Provides graphics, printing, and publicity support for library programs and events at the individual library's request.
- Arranges special ADA accommodations requested in advance by audience members.
- Researches, develops, and implements marketing strategies and campaigns for HSPLS.
- Works with the Office of the State Librarian (OSL), Friends of the Library of Hawaii, and public and private groups to identify and pursue funding, donation and program partnership opportunities.
- Monitors grant and other funding opportunities, writes grant applications, coordinates and completes grant activities and requirements, and evaluates outputs and outcomes in relation to program objectives.
- Plans, organizes, coordinates, seeks funding for, and evaluates training opportunities for library staff in conjunction with the Office of the State Librarian, and Hawaii State Library's Children's and Young Adult Services Oahu-wide Coordinators.
- Assists ESSS with maintaining informational content on HSPLS' website.
- Creates HSPLS announcements and program information for the system's website.
- Maintains HSPLS' Publications in Print program.
- Advocates and conducts outreach activities to target audiences to promote library awareness, services and programs.
- Provides guidance and support in the area of volunteer services to local libraries.
- Coordinates special events on behalf of HSPLS (i.e. ground breaking, grand openings, media conferences) requiring special protocol.
- Maintains alignment of HSPLS communications across all media platforms (i.e., HSPLS website, Facebook, Twitter.)

## ADMINISTRATIVE SERVICES BRANCH (ASB)

The Administrative Services Branch supports the State Librarian with systems and controlling activities in the areas of fiscal, budget, procurement, inventory management, federal grants accounting, data collection and analysis, book and mail delivery service, supply storeroom facility management and Capital Improvement Programs.

### FISCAL SERVICES SECTION

Maintains a system that provides accounting, financial, and budgetary information as well as technical assistance services. Responsible for the compliance to the state's procurement rules and regulations. Assists in the preparation of bid specifications and contracts. Manages the inventory program. Processes payments to vendors and wages to the employees.

- Develops and consolidates the Planning-Program Budgeting multi-year financial plans which includes biennial and supplemental operating budget documents.
- Prepares response to legislators', Governor's, or Department of Budget and Finance's requests for supporting budget information or justifications.
- Assists in the preparation, coordination, and execution of the HSPLS operating budget.
- Prepares the special and federal fund budget documents, justifications and assembles supporting documents and worksheets for submittal to the Board of Education and the Department of Budget and Finance.
- Performs budget analysis and review to determine effectiveness and adherence to financial planning and department goals.
- Prepares revenue and expenditure projections and financial plans. Analyzes prior years' revenues and expenditures to uncover trends, patterns, and significant deviations.
- Prepares financial reports for HSPLS funds. Prepares a monthly variance analysis report comparing actual expenditures to budgets. Prepares an annual special fund report for the legislature.
- Compiles quarterly and annual financial reports to the Institute of Museum and Library Services, the federal agency which administers our Library Services and Technology Act grants; draws down cash as needed and provides technical assistance to library staff and management on federal rules, regulations and programs.
- Assists the federal funds program coordinator with the required financial information to prepare grant requests or special reports.
- Develops and directs the maintenance of the accounting records for HSPLS funds.
- Reviews accounting data; ensures posting entries have been entered correctly into the proper fund; investigates and determines causes of and the resolution of all discrepancies.
- Maintains and updates an internal accounting system for HSPLS; reconciles the internal HSPLS financial records with DAGS' records; prepares journal entries for complex accounting transactions, including transfers, adjustments, corrections, etc.; maintains the general ledgers and related subsidiary journals.
- Provides training, advice, and analysis on fiscal matters.
- Recommends and/or implements changes to fiscal policies and procedures.
- Manages the HSPLS' internal audit program. Reviews the audit results and writes the internal audit report with recommendations. Performs the follow-up audit to verify that all deficiencies have been corrected or addressed.

### Accounting Unit

- Procures goods and services for HSPLS. Executes and encumbers all forms of contracts.
- Provides guidance and technical assistance on all aspects of purchasing.
- Performs fund validation function before processing of purchase orders.
- Coordinates the expenditure of appropriated funds.
- Responsible for the processing and monitoring of petty cash accounts.
- Performs internal audits of library branches on their cash deposits and inventory.
- Responsible for HSPLS equipment inventory. Processes, audits and maintains records of all equipment transactions to ensure that equipment is properly inventoried and disposed of. Coordinates the annual physical inventory.

### Pre-Audit Unit

- Provides training and assistance in all activities of the payroll and vouchering functions.

### Vouchering Sub-Unit

- Processes and audits claim documents to ensure that vendors are properly paid.
- Review and process expenditures and summary warrant vouchers to ensure accuracy, timeliness of payment, and correct uniform accounting codes.

### Payroll Sub-Unit

- Processes and audits all payroll documents to ensure that HSPLS employees are properly compensated.
- Audits and maintains all leave accounting records to ensure that HSPLS employees are properly credited and charges for their vacation and sick leave.
- Processes and audits wage separation reports for unemployment insurance purposes, loans, etc.
- Processes and audits workers' compensation payments after proper review and approvals.

## LOGISTICS SUPPORT SERVICES

Coordinates support services for library facilities, such as maintenance of buildings and grounds; excess equipment inventory; procurement, distribution, and accounting of all HSPLS operating supplies; delivery services; operation of the CIP Program; and security services for the protection of State property and the personal safety of the library users and staff at all times during each library's hours of operation.

- Provides mail collection/delivery, and intra-library loan delivery services on Oahu.
- Coordinates the building repair, alterations, and maintenance program.
- Coordinates the purchase, storage, and delivery of custodial supplies and equipment. Manages the operations of the warehouse building.
- Complies and consolidates the repair and alterations program and budget documents.
- Reviews utilization of existing library facilities.
- Plans and administers a statewide program to improve safety, security and civil defense for the Public Library System.
- Establishes and implements a cost effective and energy savings program for the Public Library System.

## Security and Safety

- Conducts general patrolling within the building and grounds.
- Maintains laws, and rules and regulations for the protection and security of property and provides a safe environment for library users and staff.
- Protects property and equipment against fire, theft, vandalism and other irregularities.
- Maintains order within the library, its meeting rooms, grounds, and parking lots.
- Reports to the Head Librarian or designee any problem within the library, such as suspicious persons or unusual incidences.
- Secures the building at closing time.

## HUMAN RESOURCES OFFICE

- Administers the personnel and industrial relations staff services for the public library system.

### Personnel Management Staff

- Serves as liaison or representative on collective bargaining, personnel management, grievance and arbitration, and other related matters with the Department of Human Resources Development and other agencies.
- Reviews, recommends, coordinates, and maintains the departmental personnel management manual, which contains policies, procedures and guidelines; updates the manual and distributes to libraries and departments.
- Manages the position classification and compensation plan.
- Plans, directs and coordinates the recruitment, interviewing and selection services.
- Maintains current organizational charts and personnel lists.
- Administers job-sharing program.
- Manages the employee benefit programs including temporary disability, health/dental plans, deferred compensation, incentive and service awards, leave sharing, REACH, and retirements.
- Plans, coordinates and implements educational, informational and training programs on personnel issues.
- Provides analytical reports of personnel activities.
- Employee performance evaluation program – Maintains records, timetables, conducts training for supervisors.
- Recommends and helps implement training opportunities to improve employee performance and resolve workplace conflict.

### Personnel Services

- Reviews and processes applications for participation in employee benefits programs.
- Reviews, processes and maintains all personnel forms relating to recruitment, referral and placement actions.
- Establishes and maintains files, class specifications and compensation plans, classification and transaction logs and cards, position files, and other procedural and guideline materials; prepares monthly, quarterly and other statistical reports.
- Maintains information on vacancies and filling status; and prepares reports as scheduled or requested.
- Trains branch personnel on new procedures and changes in procedures.
- Assists staff and supervisors in filling out various personnel forms; maintains forms supplies; puts together forms packets and checklists. Revises and stocks new forms as needed.



## HAWAII STATE LIBRARY

The Hawaii State Library (HSL) is the central library of the Hawaii State Public Library System (HSPLS). This library serves as the back-up resource for all HSPLS libraries. HSL sections and subject specialists provide system-wide support in areas such as collection development, age-level services, and other library functions. Some system-wide services are coordinated here, such as interlibrary loan requests, electronic reference service, and telephone reference. HSL is the major archive for federal and state documents, Hawaii & Pacific materials, and other historic, rare, and/or fragile materials.

- Develops and maintains in-depth library resources and provides statewide selection, reference and bibliographic services. Provides government documents depository services.
- Provides consultation, orientation and training in library services.
- Develops and maintains inter-agency liaison, interjurisdictional cooperative ventures programs and services.
- Serves as the central hub for library network services within and beyond Hawaii for interlibrary loans and reference services for audio and/or visual data transmission, reception and display, and for other services. Researches, plans, demonstrates, tests and evaluates innovative approaches and new technology.

### FEDERAL DOCUMENTS SECTION

The Federal Documents Section provides access to federal government publications through the Federal Depository Library Program and access to patent and trademark information through the Patent and Trademark Depository Library Program.

- Maintains collection of federal government publications and patent and trademark search resources by acquiring, cataloging, and processing materials in paper, microform, and electronic formats.
- Provides in-depth reference services using a comprehensive collection of commercial and federal government access tools and publications in paper, microform, and electronic formats.
- Serves as the lead federal depository library for the library system.
- Serves as the sole patent and trademark depository library for the library system and the state.

### CHILDREN'S SECTION

The Children's Section provides age-specific assistance to readers in the pre-school through grade six levels.

- Provides reference and reader services to children. Selects and maintains a comprehensive major collection of books and other materials appropriate to this age level.
- Maintains a historical research collection in children's literature for adult use.
- Provides reference and reader services to adults in the use of children's materials.
- Coordinates programs for children in Oahu libraries.
- Participates in the review and selection of materials from all that is available and in print for children.
- Prepares publications, bibliographies and promotional materials to be printed for use by libraries throughout the State and the public.

- Provides consultation, orientation and training in children's library services to librarians throughout the State.
- Maintains liaison and cooperation with libraries of various jurisdictions.
- Schedules and prepares programs for the public and school classes preschool through grade 6.
- Oversees collection development and children's programming in all Oahu public libraries.

#### YOUNG ADULT SECTION

The Young Adult Section provides age-specific assistance to readers in school grade seven through grade twelve.

- Provides reference and readers advisory services to young adults.
- Selects and maintains a collection of books and other materials appropriate to this age level.
- Coordinates book talk team for young adults on Oahu.
- Participates in the review and selection of young adult materials from all that is available in print.
- Prepares publications, bibliographies and promotional materials to be printed for use by libraries and the public.
- Provides consultation, orientation and training in young adult library services.
- Maintains liaison and cooperation with libraries of other jurisdictions.
- Coordinates Career Day Program on Oahu.

#### SERIALS SECTION

The Serials Section acts as the primary clearinghouse of magazines, newspapers, and other periodicals Statewide.

- Maintains for the system an in-depth collection of magazines, newspapers, and other periodicals Statewide.
- Selects and orders subscriptions in all formats for the HSL.
- Develops a balanced collection based on the needs of the general public, researchers, and the subject sections of the HSL.
- Coordinates periodicals contracts for the system, drafting bid specifications and monitoring vendor performance.
- Prepares, compiles, edits, and maintains the Serials Holding List, a major reference tool listing periodicals available in all Hawaii public libraries.
- Provides general reference service, backfile retrieval service and assistance in the use of the collections; prepares bibliographies and related lists for distribution and/or publishing; provides in-depth reference, research and bibliographic services on or about serials.
- Provides consultation, orientation, and training in serials-related library services.
- Maintains liaison and cooperation with libraries of other jurisdictions, including photocopy/fax service.
- Acts as mail center, receiving and delivering incoming mail, and metering outgoing mail.

### Serials Processing

- Maintains master serials and check-in records (serials control) according to current bibliographic standards.
- Receives and checks-in periodicals and newspapers on a daily basis.
- Processes all periodicals and newspapers added to the collection.
- Routes selected periodical issues to selected sections within the HSL.
- Claims non-receipt of periodicals and newspapers as necessary.

### SOCIAL SCIENCE AND PHILOSOPHY SECTION

### BUSINESS, SCIENCE AND TECHNOLOGY SECTION

### LANGUAGE, LITERATURE AND HISTORY SECTION

The Social Science and Philosophy Section; Business, Science and Technology Section; and Language, Literature and History Section provide reader assistance in their respective subject areas.

- Develops and maintains specialized in-depth collections of books and other media in assigned subject areas.
- Provides in-depth reference, research and bibliographic service; interprets the collections and assists users and other libraries with various needs.
- Reviews and selects materials from all that is available and in print in assigned subject areas for selection and purchase by libraries.
- Prepares publications, bibliographies and promotional materials to be printed for use by libraries and the public.
- Organizes and maintains special, supplementary and current data files.
- Provides consultation, orientation and training in library services in their respective areas.
- Maintains liaison and cooperation with libraries of other jurisdictions.

### HAWAII AND PACIFIC SECTION

The Hawaii and Pacific Section provides reference and customer assistance in all areas associated with Hawaii, the South Pacific, Australia, and New Zealand.

- Develops and maintains specialized in-depth collections of books and other media in assigned subject areas.
- Acquires, records, processes, and maintains an in-depth collection of magazines, newsletters, and annual reports.
- Provides comprehensive reference, research and bibliographic service; interprets the collections and assists users and other libraries with various needs.
- Reviews and selects materials from all that is available and in print in assigned subject areas for selection and purchase by libraries.
- Prepares publications, bibliographies and promotional materials to be printed for use by libraries and the public.
- Organizes and maintains special, supplementary and current data files and indexes.

- Provides consultation, orientation and training in library services in respective specialty areas.
- Maintains liaison and cooperation with libraries of other jurisdictions.
- Develops and maintains collections of Hawaiiana and Pacifica at the exhaustive and comprehensive levels, respectively, for research, historical and reference purposes.
- Provides comprehensive research, reference and interloan service to the public, state agencies, libraries, and organizations locally, nationally and internationally.
- Provides consultation and assistance with genealogy research.

#### Indexing

- Plans, organizes and coordinates an index to the Honolulu Advertiser and Honolulu Star Bulletin newspapers.
- Coordinates printing and distribution of biennial index of aforementioned newspapers.
- Provides statewide and out-of-state assistance with both online and print indices.
- Supports the Hawaii and Pacific Section through reference, other auxiliary services and special projects.

#### Hawaii Documents Center

- Responsible for Hawaii state and county government publications for the system.
- Provides Hawaii government documents depository services, including procurement, listing, indexing, microfilming, storage, and retrieval.
- Develops and updates procedures for distribution of documents to libraries within the system, and to facilitate public access. Provides statewide and out-of-state assistance with Hawaii state and county documents.
- Plans, organizes and maintains monthly listing and a biennial cumulative index of Hawaii state and county documents for publication and distribution to libraries.
- Provides assistance with U.S. Census Bureau reports and data as a Hawaii State Data Center Affiliate.
- Supports the Hawaii and Pacific Section through reference, other auxiliary services and special projects.

#### ART, MUSIC AND RECREATION AND AUDIOVISUAL SECTION

The Art, Music and Recreation, and Audiovisual Section provides reader assistance in all areas associated with art, music and recreation. The audiovisual section provides reader assistance, booking and circulation services for audiovisual media in those areas and other subject areas.

- Provides in-depth reference, research and bibliographic services; interprets the collections and assists users and other libraries with various needs.
- Reviews and selects materials from all what is available in print in assigned subject areas for selection and purchase by libraries.
- Prepares publications, bibliographies and promotional materials to be printed for use by libraries and the public.

- Creates original cataloging, indexes and databases for musical scores, sheet music and non-text materials.
- Organizes and maintains special, supplementary and current data files.
- Provides consultation, orientation and training in library services in their respective areas.
- Maintains liaison and cooperation with libraries and organizations of other jurisdiction.
- Maintains an extensive circulating pictorial resource file covering all topics in subject areas.

#### Audiovisual Services

- Provides booking and circulation services for audiovisual media.
- Provides in-depth reference, research and bibliographic services; interprets the collections and assists users and other libraries with various needs.
- Reviews and selects materials from all that is available in the audiovisual media for selection and purchase by libraries.
- Prepares publications, bibliographies and promotional materials to be printed for use by libraries and the public.
- Creates original cataloging, indexes and databases for audiovisual materials.
- Organizes and maintains special, supplementary and current data files.
- Provides consultation, orientation and training in library services in the audiovisual media.
- Maintain liaison and cooperation with libraries of other jurisdictions.

#### LIBRARY OPERATIONS SECTION

The Library Operations Section is responsible for all aspects of circulation services and for facilities maintenance and security of the Hawaii State Library.

- Supervises and operates all circulation services for the Hawaii State Library, except audiovisual, and provides liaison with other libraries.
- Supervises and provides interlibrary loans.
- Supervises building maintenance.
- Supervises building security.
- Responsible for shared equipment and computer equipment, and assists with training in new technology for professional and non-professional staff.
- Responsible for signs, directions, general building maintenance.
- Serves as central information and reference center.

#### Circulation Unit

##### Clerical Services

- Processes bills for damaged library materials.
- Opens bulk mail packages and routes items to the proper units or processes items for return to the shelves.

- Provides circulation services at the Circulation Desk and over the telephone.
- Provides assistance with telephone switchboard operations.

#### Shelving Services

- Arranges and shelves returned library materials.
- Maintains order in the book stacks.
- Notifies librarians when there is no room on the shelf to shelve.
- Does shelf reading to maintain accuracy of library materials on the shelves.
- Assists in providing circulation services at the Circulation Desk.

#### Special Services

- Assigned personnel serves as the senior representative on duty at the Circulation Desk; as such, makes decisions regarding overdue fines and responds to questions regarding borrowers' records, circulation rules and procedures.
- Processes library materials for customer pick-up.
- Assists in Circulation Unit staff training.
- Provides orientation for all new Circulation Unit staff members.

#### Telephone Renewal Services

- Renews library materials over the telephone.
- Places charges for video rental against customer's library card when renewing videos.
- Answers customers' questions regarding borrowing record and library procedures.
- Provides assistance with telephone switchboard operations.

#### Interlibrary Loans Unit

Provides intraloon and interloan services within the Hawaii State Public Library System and between the Hawaii State Public Library System and other libraries, statewide, nationally, and internationally.

- Provides intraloon of library materials within the Hawaii State Public Library System.
- Plans and develops inter and intraloon procedures with other libraries.
- Provides guidance, assistance and counsel statewide for inter and intraloon.

#### Acquisition Records Unit

- Receives and processes library materials.
- Receives and processes duplicates and new materials.
- Makes all additions, deletions, and corrections to the item and database.

#### Maintenance Unit

- Provides custodial and related services.

### Central Reference and Information Unit

- Provides direction and quick reference to customers in locating reference material.
- Responsible for directing customers to other sections of the library containing the information requested.
- Maintains current listing of available information and programs within HSPLS.
- Maintains information on State and other government entities and their locations.
- Maintains central listing of library equipment available for public use.
- Provides information on the use of on-line public access catalog.
- Maintains liaison and cooperation with libraries of other jurisdictions.

### Telephone Reference Unit

- Conducts reference interviews over the telephone with customers searching for reference materials. Answers quick reference questions or directs customers to the HSL section or library containing the information requested.
- Maintains current listing of available information and programs within the libraries Statewide.
- Maintains information on State and other government entities and their locations.
- Maintains central listing of library equipment available for public use.
- Provides information on the use of on-line public access catalog.
- Maintains liaison and cooperation with libraries of other jurisdictions.
- Provides reference information over the telephone.

## LIBRARY FOR THE BLIND AND PRINT DISABLED

The Library for the Blind and Print Disabled (LBPD) serves as a regional library and machine lending agency under the National Library Service for the Blind and Print Disabled (NLS), as defined in Public Law 89-522. It provides library services to the visually impaired, blind and others who are unable to handle regular print materials. Its service area includes Hawaii and U.S. Affiliated Pacific Islands. LBPD also serves as a Branch Library of the Hawaii State Public Library System. LBPD performs the following core services:

### PUBLIC SERVICES SECTION (PSS)

- Acquires, maintains and circulates library materials in accessible formats like braille and audio for the blind and print disabled, including items produced by the National Library Service for the Blind and Print Disabled.
- Provides reference and readers' advisory services to patrons statewide.
- Acquires materials from other regional and outside libraries and agencies when requested by patrons.
- Provides educational outreach and orientation to teachers and other persons or organizations who require information on library services for the disabled.
- Assigns audio players and other equipment to registered patrons. Monitors equipment maintenance and inventory and submits reports to the National Library Service for the Blind and Print Disabled, and to applicable state agencies.
- Provides support services to the public libraries on the islands of Hawaii, Kauai, and Maui that assist LBPD with the distribution of machines and materials to local communities.
- Oversees services provided by the Guam Subregional Library for the Blind and Print Disabled.
- Provides publicly-available computers with screen reader and screen magnification programs for the disabled.
- Processes applications for service.

### TRANSCRIBING SERVICES SECTION (TSS)

- Transcribes books on Hawaii-related topics into digital audio format for circulation to registered patrons.
- Upon request, transcribes documents into braille, large print, audio or electronic formats in accordance with national standards.
- Priority is given to students, patrons, government agencies and nonprofit agencies who work with the blind and print disabled.
- Provides Radio Reading Service Hawaii, a closed-circuit radio broadcast that specializes in programming of significance to the local disabled community.
- Coordinates a staff of volunteers who narrate books and record articles for the radio broadcast.



## PUBLIC LIBRARIES BRANCH

The Public Libraries Branch (PLB) oversees the statewide operations of 48 library branch locations across the six islands of Hawaii, Kauai, Lanai, Maui, Molokai and Oahu. These locations are grouped into the two regions of West Oahu/Hawaii and East Oahu/Maui (including Lanai and Molokai) and Kauai. The 48 branch libraries and their regions are:

### West Oahu/Hawaii Region

Twenty-three (23) locations from the West Oahu and Hawaii Districts:

- Aiea Public Library
- Ewa Beach Public and School Library
- Kahuku Public and School Library
- Kapolei Public Library
- Mililani Public Library
- Nanakuli Public Library
- Pearl City Public Library
- Salt Lake-Moanalua Public Library
- Wahiawa Public Library
- Waialua Public Library
- Waipahu Public Library
- Hilo Public Library
- Honokaa Public Library
- Kailua-Kona Public Library
- Keaa Public & School Library
- Kealahou Public Library
- Laupahoehoe Public & School Library
- Mountain View Public & School Library
- Naalehu Public Library
- North Kohala Public Library
- Pahala Public & School Library
- Pahoa Public & School Library
- Thelma Parker Public & School Library

### Maui/East Oahu/Kauai Region

Twenty-five (25) locations from the Maui, East Oahu and Kauai Districts:

- Hana Public & School Library
- Kahului Public Library
- Kihei Public Library
- Lahaina Public Library
- Lanai Public & School Library
- Makawao Public Library
- Molokai Public Library
- Wailuku Public Library
- Aina Haina Public Library
- Hawaii Kai Public Library
- Kailua Public Library
- Kaimuki Public Library
- Kalihi Public Library
- Kaneohe Public Library
- Liliha Public Library
- Manoa Public Library
- McCully Public Library
- Waikiki Public Library
- Waimanalo Public & School Library
- Lihue Public Library
- Hanapepe Public Library
- Kapaa Public Library
- Koloa Public & School Library
- Princeville Public Library
- Waimea Public Library

The primary purpose of PLB is to ensure that libraries under their supervision operate in accordance to the HSPLS Administrative Rules and to work with the front line managers to meet the goals and objectives of the system in a safe and consistent manner statewide.

The Public Libraries Branch as a section may hire, train and mentor employees; assist libraries in developing and promoting their services and collections; coordinate pilot programs to test innovative programs and techniques; addresses and resolves library concerns and needs; works to ensure assessment measures of effectiveness are standardized and good business practices are followed in the collection of data; provides guidance and assistance with personnel matters at the branch level as needed.

The primary function of the two (2) Librarian VI District Administrator positions, within PLB is the direct supervision of the managers of the public library branches and oversight on their program of services. These positions ensure branches are operating in accordance with the policies established by the Board of Education and the State Librarian under the direction of the Managing Librarian II. The primary duties of the District Administrators are to:

- Handle personnel matters such as mediations, investigations and maintenance of the Performance Appraisal Systems for the staff members in their libraries as needed.
- Address patron complaints and concerns that could not be resolved at the Librarian V level within PLB for branches within their regions.
- Works with the Managing Librarian II to allocate materials budget and staffing to the various branches within their region.
- Works as primary contact and assists the Managing Librarian II in any planning and design of new libraries.
- These positions are required to handle information of a confidential nature.
- These positions work on special projects as assigned by the Managing Librarian II and may serve as the Managing Librarian II in their absence.
- Trains new managers in library operations, existing staff on new technology and/or procedures and initiates re-training of managers as needed.
- Provides guidance to managers in the development of needs-based budgets for public library branches within PLB statewide.
- Measures and reports on district services statewide.
- Provides input to the State Librarian's Administrative team as requested and/or required.
- Works with managers, the State Librarian's Administrative Team and DAGS as needed to address library facility, security, safety, accounting and other system issues.

Department of Education - Hawaii State Public Library System  
 Functions

Table 1

<u>Division</u>	<u>Description of Function</u>	<u>Activities</u>	<u>Prog ID(s)</u>	<u>Statutory Reference</u>
DOE	Refer to the attached HSPLS functional statement	Refer to attached.	EDN407	HRS Chapter 312

Department of Education - Hawaii State Public Library System  
Department-Wide Totals

Table 2

Fiscal Year 2022					
Act 9 / 2020 Appropriation	Reductions	Additions	Emergency Appropriations	Total FY22	MOF
\$ 37,124,076.00	\$ (3,545,809.00)			\$ 33,578,267.00	A
\$ 4,000,000.00				\$ 4,000,000.00	B
\$ 1,365,244.00				\$ 1,365,244.00	N
\$ 42,489,320.00	\$ (3,545,809.00)	\$ -	\$ -	\$ 38,943,511.00	Total
Fiscal Year 2023					
Act 9 / 2020 Appropriation	Reductions	Additions		Total FY23	MOF
\$ 37,124,076.00	\$ (3,565,809.00)			\$ 33,558,267.00	A
\$ 4,000,000.00				\$ 4,000,000.00	B
\$ 1,365,244.00				\$ 1,365,244.00	N
\$ 42,489,320.00	\$ (3,565,809.00)	\$ -	\$ -	\$ 38,923,511.00	Total

Department of Education - Hawaii State Public Library System  
 Program ID Totals

Table 3

Prog ID	Program Title	MOF	As budgeted (FY22)			As budgeted (FY23)			Governor's Submittal (FY22)				Governor's Submittal (FY23)			
			Pos (P)	Pos (T)	\$\$\$	Pos (P)	Pos (T)	\$\$\$	Pos (P)	Pos (T)	\$\$\$	Percent Change of \$\$\$\$	Pos (P)	Pos (T)	\$\$\$	Percent Change of \$\$\$\$
EDN407	Public Libraries	A	561.50	1.00	37,124,076	561.50	1.00	37,124,076	561.50	1.00	33,578,267	-9.55%	561.5	1	\$ 33,558,267	-9.61%
EDN407	Public Libraries	B			4,000,000			4,000,000			4,000,000				\$ 4,000,000	
EDN407	Public Libraries	N			1,365,244			1,365,244			1,365,244				\$ 1,365,244	

Department of Education - Hawaii State Public Library System  
Budget Decisions

Prog ID	Sub- Org	Description of Request	MOF	Initial Department Requests						Budget and Finance Recommendations						Governor's Decision					
				FY22			FY23			FY22			FY23			FY22			FY23		
				Pos (P)	Pos (T)	\$\$\$	Pos (P)	Pos (T)	\$\$\$	Pos (P)	Pos (T)	\$\$\$	Pos (P)	Pos (T)	\$\$\$	Pos (P)	Pos (T)	\$\$\$	Pos (P)	Pos (T)	\$\$\$
EDN407		Payroll - Elimination of Overtime	A			\$ (53,000)			\$ (53,000)			\$ (53,000)			\$ (53,000)			\$ (53,000)			\$ (53,000)
EDN407	QB	Payroll - Elimination of Sabbatical Leave	A			\$ (15,580)			\$ (15,580)			\$ (15,580)			\$ (15,580)			\$ (15,580)			\$ (15,580)
EDN407		Payroll - Elimination of Student Helpers	A			\$ (870,000)			\$ (870,000)			\$ (870,000)			\$ (870,000)			\$ (870,000)			\$ (870,000)
EDN407		Payroll - Elimination of Substitute	A			\$ (354,801)			\$ (354,801)			\$ (354,801)			\$ (354,801)			\$ (354,801)			\$ (354,801)
EDN407	QM	Reduction - RFID - Equipment	A			\$ (240,000)			\$ (240,000)			\$ (240,000)			\$ (240,000)			\$ (240,000)			\$ (240,000)
EDN407	QM	Reduction - Equipment (Others)	A			\$ (80,000)			\$ (80,000)			\$ (80,000)			\$ (80,000)			\$ (80,000)			\$ (100,000)
EDN407		Reduction - Other Current Expenses	A			\$ (1,936,428)			\$ (1,936,428)			\$ (1,223,428)			\$ (1,223,428)			\$ (1,223,428)			\$ (1,223,428)
EDN407	QM	Reduction - Library Books and Materials	A			\$ (709,000)			\$ (709,000)			\$ (709,000)			\$ (709,000)			\$ (709,000)			\$ (709,000)
						\$ (4,258,809)			\$ (4,258,809)			\$ (3,545,809)			\$ (3,545,809)			\$ (3,545,809)			\$ (3,565,809)

Department of Education - Hawaii State Public Library System  
Proposed Budget Reductions

Table 5

Prog ID	Sub- Org	Description of Reduction	Impact of Reduction	MOF	FY22			FY23			FY21 Restriction (Y/N)
					Pos (P)	Pos (T)	\$\$\$\$	Pos (P)	Pos (T)	\$\$\$\$	
EDN407		Governor's decision budget reduction - restriction and contingency restriction	Library branch reduced hours or closures due to staff shortage	A			\$ (3,545,809)			\$ (3,565,809)	Y

Department of Education - Hawaii State Public Library System  
Proposed Budget Additions

Table 6

<u>Prog ID</u>	<u>Sub-Org</u>	<u>Addition Type</u>	<u>Prog ID Priority</u>	<u>Dept-Wide Priority</u>	<u>Description of Addition</u>	<u>Justification</u>	<u>MOF</u>	<u>FY22</u>			<u>FY23</u>		
								<u>Pos (P)</u>	<u>Pos (T)</u>	<u>\$\$\$</u>	<u>Pos (P)</u>	<u>Pos (T)</u>	<u>\$\$\$</u>
					none								



Department of Education - Hawaii State Public Library System

FB 2018 - 2021

Restrictions

<u>Fiscal Year</u>	<u>Prog ID</u>	<u>Sub- Org</u>	<u>MOF</u>	<u>Budgeted by Dept</u>	<u>Restriction</u>	<u>Difference Between Budgeted &amp; Restricted</u>	<u>Percent Difference</u>	<u>Impact</u>
2018	EDN407		A	35,325,668	\$ 3,112,570	\$ 32,213,098	-8.81%	Reduction in payroll and ability to hire needed staff to provide services
2019	EDN407		A	36,163,876	\$ 1,592,695	\$ 34,571,181	-4.40%	Reduction in payroll and ability to hire needed staff to provide services
2020	EDN407		A	38,512,179	\$ 4,117,462	\$ 34,394,717	-10.69%	Reduction in payroll and in public services and hours to provide services
2021	EDN407		A	38,582,681	\$ 4,776,456	\$ 33,806,225	-12.38%	Reduction in payroll and in public services and hours to provide services

Department of Education - Hawaii State Public Library System  
Emergency Appropriation Requests

Table 8

<u>Prog ID</u>	<u>Description of Request</u>	<u>Explanation of Request</u>	<u>MOF</u>	<u>Pos (P)</u>	<u>Pos (T)</u>	<u>\$\$\$</u>
EDN407	No Emergency Appropriation Requests					

Department of Education - Hawaii State Public Library System  
 Expenditures Exceeding Appropriation Ceilings in FY22 and FY23

Table 9

<u>Prog ID</u>	<u>MOF</u>	<u>Date</u>	<u>Appropriation</u>	<u>Amount Exceeding Appropriation</u>	<u>Percent Exceeded</u>	<u>Reason for Exceeding Ceiling</u>	<u>Legal Authority</u>	<u>Recurring (Y/N)</u>	<u>GF Impact (Y/N)</u>
						No Expenditures Exceeding Appropriation Ceilings			

Department of Education - Hawaii State Public Library System  
 Intradepartmental Transfers in FY22 and FY23

Table 10

<u>Actual or Anticipated Date of Transfer</u>	<u>MOF</u>	<u>Pos (P)</u>	<u>Pos (T)</u>	<u>\$\$\$</u>	<u>From Prog ID</u>	<u>Percent of Program ID Appropriation Transferred From</u>	<u>To Prog ID</u>	<u>Percent of Receiving Program ID Appropriation</u>	<u>Reason for Transfer</u>	<u>Recurring (Y/N)</u>
None										

Department of Education - Hawaii State Public Library System  
Vacancy Report as of November 30, 2020

Prog ID	Sub- Org	Date of Vacancy	Expected Fill Date	Position Number	Position Title	Exempt (Y/N)	SR Level	BU Code	Perm Temp (P/T)	FTE	MOF	Budgeted Amount	Actual Salary Last Paid	Authority to Hire (Y/N)	Occupied by 89 Day Hire (Y/N)	# of 89 Hire Appts	Describe if Filled by other Means	Priority # to Retain	Island and Library
EDN407	QF	08/01/19		014819	LIBRARY ASSISTANT III	N	SR07	03	P	1.00	A	\$ -	\$ 29,088					1	Hawaii   Hilo
EDN407	QF	03/24/20		015684	LIBRARIAN V	N	SR24	23	P	1.00	A	\$ 64,476	\$ 59,616					1	Hawaii   Hilo
EDN407	QF	04/01/20		012567	LIBRARY ASSISTANT IV	N	SR09	03	P	1.00	A	\$ 43,008	\$ 43,008					1	Hawaii   Hilo
EDN407	QF	03/01/20		028757	LIBRARIAN IV	N	SR22	23	P	1.00	A	\$ -	\$ 75,432					1	Hawaii   Kailua-Kona
EDN407	QF	05/01/20	1/16/2021	033129	JANITOR II	N	BC02	01	P	1.00	A	\$ 43,164	\$ 42,900	Y				1	Hawaii   Kailua-Kona
EDN407	QF	08/23/20		045968	LIBRARY ASSISTANT IV	N	SR09	03	P	1.00	A	\$ 32,664	\$ 31,440					1	Hawaii   Kailua-Kona
EDN407	QF	10/01/20		000291	LIBRARY ASSISTANT III	N	SR07	03	P	1.00	A	\$ 29,088	\$ 31,380					1	Hawaii   Keaau
EDN407	QF	03/14/20	1/16/2021	000299	JANITOR II	N	BC02	01	P	1.00	A	\$ -	\$ 21,450	Y				1	Hawaii   Kealakekua
EDN407	QF	09/17/20		042798	LIBRARIAN III	N	SR20	13	P	1.00	A	\$ 55,092	\$ 55,200					1	Hawaii   North Kohala
EDN407	QF	10/16/19		007734	LIBRARY TECHNICIAN VII	N	SR15	03	P	1.00	A	\$ -	\$ 44,388					1	Hawaii   Pahala
EDN407	QF	07/16/20		015447	LIBRARY ASSISTANT III	N	SR07	03	P	1.00	A	\$ 29,088	\$ 29,088					1	Hawaii   Pahoa
EDN407	QF	11/28/20		023996	LIBRARY ASSISTANT III	N	SR07	03	P	1.00	A	\$ 29,088	\$ 31,380					1	Hawaii   Pahoa
EDN407	QM	03/30/18		027021	AUTOMTD SYS EQUIP TECH I	N	BC14	01	P	1.00	A	\$ -	\$ 62,748				TA	1	Kauai   ESSS (Technology)
EDN407	QH	10/04/20		000040	LIBRARY ASSISTANT III	N	SR07	03	P	1.00	A	\$ 29,088	\$ 31,380					1	Kauai   Hanapepe
EDN407	QH	08/01/19		000039	LIBRARIAN V	N	SR24	23	P	1.00	A	\$ -	\$ 69,732				TA	1	Kauai   Lihue
EDN407	QH	03/14/20		021966	LIBRARIAN III	N	SR20	13	P	1.00	A	\$ -	\$ 50,916					1	Kauai   Lihue
EDN407	QE	05/01/20		015159	JANITOR II	N	BC02	01	P	1.00	A	\$ 43,164	\$ 42,396	Y				1	Oahu   Liliha
EDN407	QE	10/07/19		032302	LIBRARY ASSISTANT III	N	SR07	03	P	1.00	A	\$ -	\$ 44,724					1	Oahu   Liliha
EDN407	QE	08/01/19		034834	LIBRARY ASSISTANT III	N	SR07	03	P	1.00	A	\$ -	\$ 29,088					1	Oahu   Liliha
EDN407	QM	12/31/18		035366	AUTOMTD SYSTS EQUIP TECH I	N	BC14	01	P	1.00	A	\$ -	\$ 64,752					1	Maui   ESSS (Technology)
EDN407	QG	09/17/19		001125	LIBRARY ASSISTANT III	N	SR07	03	P	1.00	A	\$ -	\$ 29,088					1	Maui   Kahului
EDN407	QG	12/02/19		004503	LIBRARY ASSISTANT III	N	SR07	03	P	1.00	A	\$ -	\$ 29,088					1	Maui   Kahului
EDN407	QG	08/03/20		035470	LIBRARIAN III	N	SR20	13	P	1.00	A	\$ 48,948	\$ 48,948					1	Maui   Kahului
EDN407	QG	03/24/20		039410	LIBRARY ASSISTANT III	N	SR07	03	P	1.00	A	\$ -	\$ 29,088					1	Maui   Kihei
EDN407	QG	12/02/17		043921	LIBRARIAN III	N	SR20	13	P	1.00	A	\$ -	\$ 63,060					1	Maui   Lahaina
EDN407	QE	12/31/19		013281	LIBRARY ASSISTANT III	N	SR07	03	P	1.00	A	\$ -	\$ 39,720					2	Oahu   Aina Haina
EDN407	QB	08/01/18		035463	ACCOUNT CLERK II	N	SR08	03	P	1.00	A	\$ -	\$ 31,056					2	Oahu   ASB Fiscal
EDN407	QB	11/16/20		043665	ACCOUNTANT IV	N	SR22	13	P	1.00	A	\$ 57,324	\$ 67,200					1	Oahu   ASB Fiscal
EDN407	QB	12/16/19		044227	OFFICE ASSISTANT III	N	SR08	03	P	0.50	A	\$ -	\$ 19,110					2	Oahu   ASB-Fiscal
EDN407	QB	06/20/20		044971	CAPITAL IMPROVEMENTS COORD	N	SR24	13	P	1.00	A	\$ 59,616	\$ 72,528					2	Oahu   ASB-Fiscal
EDN407	QM	02/25/20		015147	INFO TECHNOLOGY BAND C	N	SR26	23	P	1.00	A	\$ 72,528	\$ 72,528					1	Oahu   ESSS (Technology)
EDN407	QM	11/01/18		023075	AUTOMTD SYSTS EQUIP TECH I	N	BC14	01	P	1.00	A	\$ -	\$ 64,752					1	Oahu   ESSS (Technology)
EDN407	QM	12/31/15		031715	AUTOMTD SYSTS EQUIP TECH I	N	BC14	01	P	1.00	A	\$ -	\$ 59,112				TA	1	Oahu   ESSS (Technology)
EDN407	QM	12/31/18		031784	AUTOMTD SYSTS EQUIP SPVSR	N	F114	02	P	1.00	A	\$ -	\$ 74,712					1	Oahu   ESSS (Technology)
EDN407	QD	08/01/20		023070	LIBRARY TECHNICIAN V	N	SR11	03	P	1.00	A	\$ 50,304	\$ 48,348					2	Oahu   Ewa Beach
EDN407	QD	06/01/19		023071	LIBRARY TECHNICIAN V	N	SR11	03	P	1.00	A	\$ -	\$ 52,296					1	Oahu   Ewa Beach
EDN407	QE	01/02/20		024336	LIBRARY ASSISTANT IV	N	SR09	03	P	1.00	A	\$ -	\$ 31,440					1	Oahu   Hawaii Kai
EDN407	QJ	12/31/15		000303	MANAGING LIBRARIAN II	N	EM05	35	P	1.00	A	\$ -	\$ 85,608				TA	1	Oahu   HSL
EDN407	QJ	11/09/18		046172	JANITOR II	N	BC02	01	P	1.00	A	\$ -	\$ 40,176	Y				1	Oahu   HSL
EDN407	QJ	08/01/20		046397	LIBRARY ASSISTANT III	N	SR07	03	P	1.00	A	\$ 29,088	\$ 29,088					2	Oahu   HSL
EDN407	QJ	09/30/17		000322	LIBRARIAN IV	N	SR22	13	P	1.00	A	\$ -	\$ 76,692					2	Oahu   HSL-AMR
EDN407	QJ	12/31/18		000310	LIBRARIAN V	N	SR24	23	P	1.00	A	\$ -	\$ 88,248					1	Oahu   HSL-BST
EDN407	QJ	04/21/19		000318	LIBRARIAN IV	N	SR22	13	P	1.00	A	\$ -	\$ 64,476					2	Oahu   HSL-EAR
EDN407	QJ	08/01/19		019328	LIBRARY ASSISTANT IV	N	SR09	03	P	1.00	A	\$ -	\$ 35,340					2	Oahu   HSL-H&P
EDN407	QJ	04/01/18		022485	LIBRARIAN IV	N	SR22	23	P	1.00	A	\$ -	\$ 63,060					1	Oahu   HSL-H&P

Department of Education - Hawaii State Public Library System  
Vacancy Report as of November 30, 2020

Prog ID	Sub- Org	Date of Vacancy	Expected Fill Date	Position Number	Position Title	Exempt (Y/N)	SR Level	BU Code	Perm Temp (P/T)	FTE	MOF	Budgeted Amount	Actual Salary Last Paid	Authority to Hire (Y/N)	Occupied by 89 Day Hire (Y/N)	# of 89 Hire Appts	Describe if Filled by other Means	Priority # to Retain	Island and Library
EDN407	QJ	06/16/20		023920	LIBRARIAN III	N	SR20	13	P	0.50	A	\$ 16,761	\$ 32,238					2	Oahu   HSL-H&P
EDN407	QJ	03/01/16		024237	LIBRARIAN III	N	SR20	13	P	0.50	A	\$ -	\$ 26,550					2	Oahu   HSL-H&P
EDN407	QJ	05/14/17		008358	LIBRARIAN III	N	SR20	13	P	1.00	A	\$ -	\$ 48,828					2	Oahu   HSL-LLH
EDN407	QJ	03/30/19		010898	LIBRARIAN IV	N	SR22	13	P	1.00	A	\$ -	\$ 55,092					1	Oahu   HSL-LLH
EDN407	QJ	08/01/20		000347	LIBRARY TECHNICIAN V	N	SR11	03	P	1.00	A	\$ 39,720	\$ 39,720					1	Oahu   HSL-LO-Circ
EDN407	QJ	12/22/18		000352	LIBRARY ASSISTANT IV	N	SR09	03	P	1.00	A	\$ -	\$ 29,868					1	Oahu   HSL-LO-Circ
EDN407	QJ	12/31/18		000357	SUPVSNGLIBRARY TECHNICIAN II	N	SR15	04	P	1.00	A	\$ -	\$ 58,092				TA	1	Oahu   HSL-LO-Circ
EDN407	QJ	09/01/18		000360	LIBRARY ASSISTANT IV	N	SR09	03	P	1.00	A	\$ -	\$ 36,276					1	Oahu   HSL-LO-Circ
EDN407	QJ	06/01/19		000366	LIBRARY ASSISTANT III	N	SR07	03	P	1.00	A	\$ -	\$ 34,020					1	Oahu   HSL-LO-Circ
EDN407	QJ	01/01/20		019185	LIBRARY ASSISTANT III	N	SR07	03	P	1.00	A	\$ -	\$ 29,088					1	Oahu   HSL-LO-Circ
EDN407	QJ	12/16/19		022893	LIBRARY ASSISTANT III	N	SR07	03	P	1.00	A	\$ -	\$ 34,020					1	Oahu   HSL-LO-Circ
EDN407	QJ	06/01/20		023210	LIBRARY ASSISTANT III	N	SR07	03	P	1.00	A	\$ 29,088	\$ 29,088					1	Oahu   HSL-LO-Circ
EDN407	QJ	03/16/20		033891	LIBRARY ASSISTANT III	N	SR07	03	P	1.00	A	\$ -	\$ 29,088					2	Oahu   HSL-LO-Circ
EDN407	QJ	09/14/20		046395	LIBRARY ASSISTANT III	N	SR07	03	P	1.00	A	\$ 29,088	\$ 29,088					2	Oahu   HSL-LO-Circ
EDN407	QJ	05/16/19		046942	LIBRARY ASSISTANT III	N	SR07	03	P	1.00	A	\$ -	\$ 29,088					2	Oahu   HSL-LO-Circ
EDN407	QJ	07/01/19		032934	LIBRARY TECHNICIAN V	N	SR11	03	P	1.00	A	\$ -	\$ 48,348				TA	1	Oahu   HSL-LO-Interlib Lns
EDN407	QJ	08/16/18		046398	LIBRARIAN III	N	SR20	13	P	1.00	A	\$ -	\$ 55,092					1	Oahu   HSL-LO-Trin
EDN407	QJ	09/01/16		000368	LIBRARY ASSISTANT III	N	SR07	03	P	1.00	A	\$ -	\$ 39,492					1	Oahu   HSL-Serials
EDN407	QJ	06/16/15		011926	LIBRARIAN IV	N	SR22	23	P	1.00	A	\$ -	\$ 47,400					2	Oahu   HSL-Serials
EDN407	QJ	11/01/13		012067	LIBRARY ASSISTANT IV	N	SR09	03	P	1.00	A	\$ -	\$ 27,756					1	Oahu   HSL-Serials
EDN407	QJ	02/01/18		023916	LIBRARY ASSISTANT III	N	SR07	03	P	0.50	A	\$ -	\$ 17,736					2	Oahu   HSL-Serials
EDN407	QJ	03/16/16		046487	LIBRARIAN III	N	SR20	13	P	1.00	A	\$ -	\$ 45,348					1	Oahu   HSL-Serials
EDN407	QJ	12/31/18		000308	LIBRARIAN V	N	SR24	23	P	1.00	A	\$ -	\$ 88,248					1	Oahu   HSL-SSP
EDN407	QE	12/16/19		112125	LIBRARIAN III	N	SR20	13	P	1.00	A	\$ -	\$ 50,916					1	Oahu   Kahuku
EDN407	QE	06/16/20		000362	LIBRARY ASSISTANT IV	N	SR09	03	P	1.00	A	\$ 41,364	\$ 39,720					1	Oahu   Kaimuki
EDN407	QE	10/01/19		043911	LIBRARIAN III	N	SR20	13	P	1.00	A	\$ -	\$ 55,092					2	Oahu   Kaimuki
EDN407	QE	01/02/20		011910	LIBRARY ASSISTANT III	N	SR07	03	P	1.00	A	\$ -	\$ 35,340					2	Oahu   Kaneohe
EDN407	QE	03/01/20		012822	LIBRARY TECHNICIAN VI	N	SR13	03	P	1.00	A	\$ -	\$ 54,432					1	Oahu   Kaneohe
EDN407	QL	05/16/20		112911	LIBRARIAN V	N	SR24	23	P	1.00	A	\$ 64,476	\$ 59,616					1	Oahu   Kapolei
EDN407	QL	12/31/19		116890	LIBRARY ASSISTANT IV	N	SR09	03	P	1.00	A	\$ -	\$ 43,008					2	Oahu   Kapolei
EDN407	QL	06/01/20		116893	LIBRARY ASSISTANT IV	N	SR09	03	P	1.00	A	\$ 48,348	\$ 48,348					1	Oahu   Kapolei
EDN407	QL	09/01/20		116898	LIBRARY ASSISTANT III	N	SR07	03	P	1.00	A	\$ 36,732	\$ 35,340					2	Oahu   Kapolei
EDN407	QI	10/01/19		019323	LIBRARY TECHNICIAN V	N	SR11	03	P	1.00	A	\$ -	\$ 48,348					2	Oahu   LBPD
EDN407	QI	12/01/18		022491	LIBRARY ASSISTANT III	N	SR07	03	P	1.00	A	\$ -	\$ 42,480					2	Oahu   LBPD
EDN407	QM	10/16/19		044993	LIBRARIAN IV	N	SR22	13	P	1.00	A	\$ -	\$ 75,432					2	Oahu   LDSS
EDN407	QE	03/20/19		049824	LIBRARIAN III	N	SR20	13	P	1.00	A	\$ -	\$ 59,616					1	Oahu   Liliha
EDN407	QB	11/01/20		046170	JANITOR II	N	BC02	01	P	1.00	A	\$ 43,164	\$ 43,764	Y				1	Oahu   LSS
EDN407	QE	07/01/20		015150	LIBRARY ASSISTANT IV	N	SR09	03	P	1.00	A	\$ 36,732	\$ 36,732					1	Oahu   Manoa
EDN407	QE	02/01/20		028748	LIBRARY ASSISTANT III	N	SR07	03	P	1.00	A	\$ -	\$ 31,440					1	Oahu   Manoa
EDN407	QE	05/01/18		019322	LIBRARY ASSISTANT III	N	SR07	03	P	1.00	A	\$ -	\$ 32,856					3	Oahu   McCully
EDN407	QE	09/09/20		031499	LIBRARY ASSISTANT III	N	SR07	03	P	1.00	A	\$ 29,088	\$ 29,088					1	Oahu   McCully
EDN407	QD	09/09/20		122427	GROUNDKEEPER I	N	BC02	01	P	0.50	A	\$ 10,791	\$ 21,882					1	Oahu   Nanakuli
EDN407	QD	12/02/19		122460	LIBRARY ASSISTANT III	N	SR07	03	P	1.00	A	\$ -	\$ 29,088					3	Oahu   Nanakuli
EDN407	QB	03/01/18		102936	ADMINISTRATIVE ASSISTANT	Y	SRNA	73	P	1.00	A	\$ -	\$ 105,756					2	Oahu   OSL Admin
EDN407	QD	07/01/20		000364	LIBRARY ASSISTANT III	N	SR07	03	P	1.00	A	\$ 35,340	\$ 34,020					1	Oahu   Pearl City

Department of Education - Hawaii State Public Library System  
 Vacancy Report as of November 30, 2020

Table 11

<u>Prog ID</u>	<u>Sub- Org</u>	<u>Date of Vacancy</u>	<u>Expected Fill Date</u>	<u>Position Number</u>	<u>Position Title</u>	<u>Exempt (Y/N)</u>	<u>SR Level</u>	<u>BU Code</u>	<u>Perm Temp (P/T)</u>	<u>FTE</u>	<u>MOF</u>	<u>Budgeted Amount</u>	<u>Actual Salary Last Paid</u>	<u>Authority to Hire (Y/N)</u>	<u>Occupied by 89 Day Hire (Y/N)</u>	<u># of 89 Hire Appts</u>	<u>Describe if Filled by other Means</u>	<u>Priority # to Retain</u>	<u>Island and Library</u>
EDN407	QD	12/16/12		006987	LIBRARY ASSISTANT III	N	SR07	03	P	1.00	A	\$ -	\$ 31,212					3	Oahu   Pearl City
EDN407	QD	11/01/20		019427	LIBRARIAN III	N	SR20	13	P	1.00	A	\$ 55,092	\$ 55,200					1	Oahu   Pearl City
EDN407	QD	11/03/20		027259	LIBRARY ASSISTANT III	N	SR07	03	P	1.00	A	\$ 29,088	\$ 29,088					2	Oahu   Pearl City
EDN407	QM	08/16/18		000316	LIBRARIAN VI	N	SR26	93	P	1.00	A	\$ -	\$ 72,528					2	Oahu   PLB Admin
EDN407	QM	12/23/19		032248	OFFICE ASSISTANT IV	N	SR10	03	P	1.00	A	\$ 34,020	\$ 32,664					3	Oahu   PLB Admin
EDN407	QM	01/16/09		119227	LIBRARIAN VI	N	SR26	03	P	1.00	A	\$ -	New psn					2	Oahu   PLB Admin
EDN407	QD	04/01/20		015113	LIBRARY ASSISTANT III	N	SR07	03	P	1.00	A	\$ 30,240	\$ 29,088					1	Oahu   Salt Lake
EDN407	QD	05/01/20	2/16/2021	045979	JANITOR II	N	BC01	01	P	1.00	A	\$ 43,164	\$ 42,900	Y				1	Oahu   Salt Lake
EDN407	QD	07/31/16		110636	LIBRARY ASSISTANT III	N	SR07	03	P	1.00	A	\$ -	\$ 29,988					2	Oahu   Salt Lake
EDN407	QM	03/01/19		033966	LIBRARIAN IV	N	SR22	13	P	1.00	A	\$ -	\$ 75,432					2	Oahu   TSS
EDN407	QD	08/20/20		022923	LIBRARY ASSISTANT III	N	SR07	03	P	1.00	A	\$ 30,240	\$ 30,240					1	Oahu   Waialua
EDN407	QE	02/05/20		011922	LIBRARIAN III	N	SR20	13	P	1.00	A	\$ -	\$ 52,956					1	Oahu   Waikiki
EDN407	QE	03/16/20		028443	LIBRARY TECHNICIAN VII	N	SR15	03	P	1.00	A	\$ -	\$ 39,720					1	Oahu   Waimanalo
EDN407	QB	06/17/19		043662	ACCOUNT CLERK II	N	SR08	03	P	1.00	A	\$ -	\$ 46,476					2	Oahu   ASB Fiscal (LSS)









Positions Established by Acts other than the State Budget as of November 30, 2020

<u>Prog ID</u>	<u>Sub-Org</u>	<u>Date Established</u>	<u>Legal Authority</u>	<u>Position Number</u>	<u>Position Title</u>	<u>Exempt (Y/N)</u>	<u>SR Level</u>	<u>BU Code</u>	<u>T/P</u>	<u>MOF</u>	<u>FTE</u>	<u>Annual Salary</u>	<u>Filled (Y/N)</u>	<u>Occupied by 89 Day Hire (Y/N)</u>
----------------	----------------	-------------------------	------------------------	------------------------	-----------------------	---------------------	-----------------	----------------	------------	------------	------------	----------------------	---------------------	--------------------------------------

No Unauthorized Positions

Department of Education - Hawaii State Public Library System  
Overtime Expenditure Summary

Table 13

Prog ID	Sub-Org	Program Title	MOF	FY20 (actual)			FY21 (actual)			FY22 (estimated)			FY23 (budgeted)		
				Base Salary \$\$\$\$	Overtime \$\$\$\$	Overtime Percent	Base Salary \$\$\$\$	Overtime \$\$\$\$	Overtime Percent	Base Salary \$\$\$\$	Overtime \$\$\$\$	Overtime Percent	Base Salary \$\$\$\$	Overtime \$\$\$\$	Overtime Percent
EDN407	QB	Office of the State Librarian	A	\$ 2,162,153	\$ 50,874	2.4%	\$ 2,285,188	\$ 2,630	0.1%	\$ 2,347,768	\$ -	0.0%	\$ 2,347,768	\$ -	0.0%
EDN407	QD	West Oahu Public Libraries	A	\$ 4,160,886	\$ 231	0.0%	\$ 4,794,162	\$ -	0.0%	\$ 4,875,781	\$ -	0.0%	\$ 4,875,781	\$ -	0.0%
EDN407	QE	East Oahu Public Libraries	A	\$ 5,147,457	\$ 248	0.0%	\$ 5,356,061	\$ -	0.0%	\$ 5,407,833	\$ -	0.0%	\$ 5,407,833	\$ -	0.0%
EDN407	QF	Hawaii Public Libraries	A	\$ 2,732,925	\$ 338	0.0%	\$ 3,109,950	\$ 63	0.0%	\$ 3,126,826	\$ -	0.0%	\$ 3,126,826	\$ -	0.0%
EDN407	QG	Maui Public Libraries	A	\$ 2,008,625	\$ 3,992	0.2%	\$ 2,100,484	\$ -	0.0%	\$ 2,118,587	\$ -	0.0%	\$ 2,118,587	\$ -	0.0%
EDN407	QH	Kauai Public Libraries	A	\$ 1,311,197	\$ 616	0.0%	\$ 1,434,004	\$ -	0.0%	\$ 1,426,701	\$ -	0.0%	\$ 1,426,701	\$ -	0.0%
EDN407	QI	Library for the Blind & Physically Handicapped	A	\$ 354,900	\$ -	0.0%	\$ 505,639	\$ -	0.0%	\$ 511,087	\$ -	0.0%	\$ 511,087	\$ -	0.0%
EDN407	QJ	Hawaii State Library	A	\$ 3,323,051	\$ -	0.0%	\$ 3,532,086	\$ -	0.0%	\$ 3,621,684	\$ -	0.0%	\$ 3,621,684	\$ -	0.0%
EDN407	QL	Kapolei Public Library	A	\$ 1,059,859	\$ 1,787	0.2%	\$ 1,178,943	\$ 197	0.0%	\$ 1,199,263	\$ -	0.0%	\$ 1,199,263	\$ -	0.0%
EDN407	QM	Library Development Services	A	\$ 2,285,757	\$ 25,198	1.1%	\$ 2,531,609	\$ -	0.0%	\$ 2,658,846	\$ -	0.0%	\$ 2,658,846	\$ -	0.0%

Department of Education - Hawaii State Public Library System  
Active Contracts as of December 1, 2020

Table 14

Prog ID	MOF	Amount	Frequency (M/A/O)	Max Value	Outstanding Balance	Term of Contract			Entity	Contract Description	Explanation of How Contract is Monitored	POS Y/N	Category
						Date Executed	From	To					E/L/P/C/G /S/*
EDN407	A	\$ 7,649	A	\$ 7,649.21	\$ 2,307.86	12/24/19	01/01/20	12/31/20	Pacific Fire Protection, Inc.	Fire extinguisher inspection and servicing - Oahu Libraries	by Accountant		S
EDN407	A	\$ 162,396	A	\$ 162,396.00	\$ -	04/08/20	06/27/20	06/26/21	Weatherproofing Technologies	Annual roof inspection and maintenance - Statewide	by Accountant		S
EDN407	A	\$ 128,560	M	\$ 128,560	\$ 66,789.00	04/14/20	06/01/20	05/31/21	Oahu Air Conditioning Services, Inc.	AC maintenance service - Various Hawaii Libraries	by Accountant		S
EDN407	A	\$ 206,000	M	\$ 206,000.00	\$ 127,733.43	07/01/20	07/01/20	06/30/21	DHRD	Worker's compenstation payment	by Accountant		S
EDN407	A	\$ 37,500	M	\$ 37,500.00	\$ 25,874.00	07/01/20	07/01/20	12/31/20	Unique Management Services, Inc.	Collection Agency	by Technology Officer		S
EDN407	A	\$ 24,000	M	\$ 24,000.00	\$ 16,000.00	07/01/20	07/01/20	06/30/21	University of Hawaii -Information Technology Services	INET Network Services for HSPLS	by Technology Officer		S
EDN407	A	\$ 18,238	O - Qtrly	\$ 18,238.00	\$ 9,119.06	07/01/20	07/01/20	06/30/21	Quadient - A Neopost USA Company	Lease of postage machine	by Accountant		E
EDN407	N	\$ 171,909	A	\$ 171,909	\$ -	07/01/20	07/01/20	06/30/21	SirsiDynix	ILS Horizon License software renewal	by Technology Officer		G
EDN407	B	\$ 200,583	A	\$ 200,583.00	\$ -	07/01/20	07/01/20	06/30/21	EBSCO Information Services	EBSCO Publishing package subscription - for HSPLS	by Accountant		G
EDN407	B	\$ 30,527	A	\$ 30,527.00	\$ -	07/01/20	07/01/20	06/30/21	Encyclopaedia Britannica, Inc.	Encyclopaedia Britrannica online database subscription - for HSPLS	by Accountant		G
EDN407	B	\$ 300,000	A	\$ 300,000.00	\$ 86,399.83	07/01/20	07/01/20	06/30/21	Ingram Library Services	Various books and materials	by TSS Manager		G
EDN407	A	\$ 14,568	A	\$ 14,568.00	\$ -	07/01/20	07/01/20	06/30/21	Bibliotheca LLC	Self check out kiosk service/maintenance	by Technology Officer		S
EDN407	A	\$ 84,357	A	\$ 84,357.00	\$ -	07/01/20	07/01/20	06/30/21	Proquest LLC	Online Database subscription - PressReader	by TSS Manager		G
EDN407	N	\$ 18,063	A	\$ 18,062.72	\$ -	07/01/20	08/01/20	07/31/21	Proquest LLC	Online Database subscription - Ancestry Library	by TSS Manager		G
EDN407	A	\$ 45,493	M	\$ 45,492.72	\$ 32,251.00	07/10/20	08/01/20	07/31/21	West Oahu Aggregate Co., Inc.	Refuse services for Oahu Libraries	by Branch Manager		S
EDN407	N	\$ 227,291	A	\$ 227,290.70	\$ -	07/16/20	09/01/20	08/31/21	Gale/Cengage Learning	Online Database subscription	by TSS Manager		G
EDN407	N	\$ 15,343	A	\$ 15,342.74	\$ -	07/17/20	09/01/20	08/31/21	Proquest LLC	Online Database subscription - Global books in Print	by TSS Manager		G
EDN407	B	\$ 15,000	A	\$ 15,000.00	\$ -	07/31/20	08/01/20	07/31/21	Recorded Books	Online subscription - Recorded Books digital audiobooks	by TSS Manager		G
EDN407	N	\$ 130,068	M	\$ 98,889.29	\$ 82,525.78	08/11/20	08/16/20	08/15/21	Hawaiian Telcom	Routed Network Services (RNS) - Statewide	by Technology Officer		S
EDN407	A	\$ 20,000	A	\$ 20,000.00	\$ -	09/08/20	09/01/20	08/31/21	Overdrive, Inc.	Overdrive Content service plan fee	by TSS Manager		G
EDN407	N	\$ 39,262	A	\$ 39,262.08	\$ -	09/08/20	01/01/21	12/31/21	Proquest LLC	Online Database subscription - Heritage Quest	by TSS Manager		G
EDN407	A	\$ 10,000	A	\$ 10,000.00	\$ -	09/17/20	10/01/20	09/30/21	Recorded Books	Recorded Books digital platform fee	by TSS Manager		G
EDN407	A	\$ 1,400,000	M	\$ 1,400,000.00	\$ 1,202,125.56	09/22/20	10/01/20	09/30/21	Star Protection Agency	Security Services - Statewide	by Accountant		S
EDN407	A	\$ 12,229	A	\$ 12,229	\$ 12,229.40	10/14/20	10/16/20	10/15/21	Johnson Controls Fire Protection LP	Fire alarm testing and inspection - Statewide	by Accountant		S
EDN407	A	\$ 6,283	O - Qtrly	\$ 6,273.00	\$ 6,282.73	12/09/20	07/01/20	06/30/21	Broadcast Resources LLC	Radio reading service - on call support and maintenance (LBPH)	by Branch Manager		S
EDN407	N	\$ 35,252	A	\$ 35,252.00	\$ 35,252.00	12/17/20	01/01/21	12/31/21	Proquest LLC	Online Database subscription - RNP West Regional Collection (Honolulu Star Advertiser)	by TSS Manager		G

Department of Education - Hawaii State Public Library System  
 Capital Improvements Program (CIP) Requests

Table 15

<u>Prog ID</u>	<u>Prog ID</u> <u>Priority</u>	<u>Dept- Wide</u> <u>Priority</u>	<u>Senate</u> <u>District</u>	<u>Rep.</u> <u>District</u>	<u>Project Title</u>	<u>MOF</u>	<u>FY22 \$\$\$</u>	<u>FY23 \$\$\$</u>
EDN407	1	1			Health and Safety	C	5,000,000	5,000,000

Department of Education - Hawaii State Public Library System  
CIP Lapses

Table 16

<u>Prog ID</u>	<u>Act/Year of Appropriation</u>	<u>Project Title</u>	<u>MOF</u>	<u>Lapse Amount</u> \$\$\$\$	<u>Reason</u>
		None			

Department of Education - Hawaii State Public Library System  
Program ID Sub-Organizations

Table 17

<u>Program ID</u>	<u>Sub- Org Code</u>	<u>Name</u>	<u>Objective</u>
EDN407	QB	Office of the State Librarian	Plans, directs, measures, evaluates & reports to the Board of Education, the Governor, the State Legislature and the public about library services, collections and programs.
EDN407	QC	Logistics Support Section	Manages centralized supplies for all staff offices/public libraries and manages delivery of materials across all library branches.
EDN407	QD	West Oahu Public Libraries	Provides equitable and free access to physical/digital collections, programs/services, places for community engagement, technology and internet access/wifi that support literacy, lifelong education, workforce development, and connection to county/state/federal resources and information.
EDN407	QE	East Oahu Public Libraries	Provides equitable and free access to physical/digital collections, programs/services, places for community engagement, technology and internet access/wifi that support literacy, lifelong education, workforce development, and connection to county/state/federal resources and information.
EDN407	QF	Hawaii Public Libraries	Provides equitable and free access to physical/digital collections, programs/services, places for community engagement, technology and internet access/wifi that support literacy, lifelong education, workforce development, and connection to county/state/federal resources and information.
EDN407	QG	Maui Public Libraries	Provides equitable and free access to physical/digital collections, programs/services, places for community engagement, technology and internet access/wifi that support literacy, lifelong education, workforce development, and connection to county/state/federal resources and information.
EDN407	QH	Kauai Public Libraries	Provides equitable and free access to physical/digital collections, programs/services, places for community engagement, technology and internet access/wifi that support literacy, lifelong education, workforce development, and connection to county/state/federal resources and information.
EDN407	QI	Library for the Blind & Physically Handicapped	Serves as the regional library of the National Library Service for the Blind & Physically Handicapped, Library of Congress. Provides eligible residents in the State of Hawaii and U.S. - Affiliated Pacific States with library materials in alternate forms.
EDN407	QJ	Hawaii State Library	As the central library for the HSPLS, HSL not only provides equitable and free access to resources and services, but supports the collection development and management of statewide resources through its sections and subject specialists.
EDN407	QK	Library Services and Technology Act	This federal Grants to States program is administered by the Institute of Museum and Library Services and provides funding to support 12 purpose areas ( <a href="https://www.ims.gov/grants/grants-state/purposes-and-priorities-1sta">https://www.ims.gov/grants/grants-state/purposes-and-priorities-1sta</a> ), all related to literacy, education, preservation, infrastructure, and library services to the public.
EDN407	QL	Kapolei Public Library	Provides equitable and free access to physical/digital collections, programs/services, places for community engagement, technology and internet access/wifi that support literacy, lifelong education, workforce development, and connection to county/state/federal resources and information.
EDN407	QM	Library Development Service	Plans, organizes, coordinates, evaluates and seeks funding for statewide programs for HSPLS.



Department of Education - Hawaii State Public Library System  
Organization Changes

Table 18

<u>Year of Change</u> <u>FY20/FY21</u>	<u>Description of Change</u>
none	