

JUDICIARY OVERVIEW

MISSION: The mission of the Judiciary, as an independent branch of government, is to administer justice in an impartial, efficient, and accessible manner in accordance with the law.

Within the Judiciary, the major program categories are court operations and support services. The programs in the court operations category serve to safeguard the rights and interests of persons by assuring an equitable and expeditious judicial process. These include the Courts of Appeal (JUD 101); and the First, Second, Third, and Fifth Circuits (JUD 310, 320, 330, and 350, respectively). Programs in the support services category enhance the effectiveness and efficiency of the judicial system by providing the various courts with administrative services such as fiscal control and direction of operations and personnel, and fall under the title of Administration (JUD 601). Within Administration are the Offices of the Administrative and Deputy Administrative Director of the Courts, and five departments – Intergovernmental and Community Relations, Policy and Planning, Information Technology and Systems, Financial Services, and Human Resources. Also attached to the Judiciary for administrative purposes only is the Judicial Selection Commission (JUD 501), which is responsible for receiving applications for judgeships in Hawai'i Courts and submitting a list of six nominees to the appointing authority for each vacancy. Further details on the functions and activities of the programs in each of the categories can be found in Table 1.

ECONOMIC IMPACT: The Judiciary recognizes that Hawaii's economy, economic outlook, visitor arrivals, job counts, and construction activities continue to be strong and that current state business sentiment remains positive. However, even with that, members of the Hawai'i Council on Revenues at their most recent meeting expressed concern that the economy may have reached the end of its current expansionary cycle during the seven-year budget window and cited some uncertainty about the future and the possible impact on the local economy. This uncertainty related to such matters as the U.S. - China trade war, a slowing global economy, the inverted debt instrument yield curve which has preceded recessions in the past, the potential effect of increased regulation of transient accommodation units, and the negative economic impact of Hawaii's population decline the past few years. In the end, the Council lowered its growth forecast for FY 2021 from 4% to 3%. The Judiciary is also aware of other challenges that could affect the availability of general funds including the ongoing collective bargaining negotiations, health care costs, State mandated commitments, and other post-employment/unfunded liabilities.

Further, while the last major recession took place some 10 years ago, the Judiciary, its employees, and the public still feel to a certain extent the effects of the \$15.4 million funding reduction (10.3% of the Judiciary's budget base) and 79 vacant position cut (4% of the Judiciary's authorized permanent staffing) that occurred during that time.

Since the recession low point in FY 2011, the Legislature has increased funding to the Judiciary by about \$42 million and provided an additional 86 permanent positions so that its budget base and permanent position count are now about \$22 million and 29 positions more than they were in FY 2009. However, most of the funds added to the Judiciary's budget since its low point in FY 2011 have related to pay restoration and collective bargaining increases so that payroll is 73.3% of the Judiciary's budget as compared to 68% in FY 2009. This equates to a loss of some \$2 million in non-payroll operating funding which, in turn, continues to impact the Judiciary in its ability to cover and restore funding in areas where it took cuts and/or where costs continue to increase – utilities, purchase of services (POS) contracts, technology requirements, repair and maintenance, and security needs, to name a few.

The impact of the budget and personnel reductions that occurred is still being felt throughout the Judiciary to a certain degree, especially considering that the Judiciary has no control over its workload, has had to accommodate that workload with less non-payroll operating financial resources, and as difficulties have occurred in trying to find qualified applicants for certain types of positions in this strong economy. Over the years, this has sometimes resulted in cases and hearings taking longer to get scheduled, heard, and resolved; and the reduction of some services being provided by or through the Judiciary. These conditions continue to linger to a certain extent, as non-payroll operating funding remains below previous levels and as the caseload, the time it takes to resolve cases, and the number of self-represented litigants continues to increase. For example, the number of pending non-criminal actions (i.e., civil actions, probate proceedings, conservator/guardianship proceedings, temporary restraining orders (TROs), small claims, etc.) at the end of FY 2019, as compared to the end of FY 2008, increased by 11% in the District Courts and 80% in the Circuit Courts. Of particular note during this 11-year period was an increase of 169% in probate proceedings, 184% in trust proceedings, 438% in Tax Court proceedings, and 53% for small claims. It should also be pointed out that Judiciary efforts to close out old District Court criminal cases have resulted in the number of cases pending for criminal actions at the end of FY 2019 to decrease by 63% relative to FY 2008 even though new filings have decreased by only 24% between these periods.

For Family Courts statewide, including criminal, children's referrals, marital actions, parental proceedings, and all other types of Family Court cases, the number of cases pending at FY 2019 year end increased by 19% compared to FY 2008. Especially noticeable were increases of 61% in marital actions, 118% in parental proceedings, and 40% in criminal actions. These increases were offset to a large extent by a 51% reduction (from 10,417 cases in FY 2008 to 5,089 cases in FY 2019) in children's referrals for law violations, status offenses, traffic situations, abuse, and other.

The budget situation that occurred during the recession resulted in the Judiciary reducing funding for POS contracts with actual POS contract expenditures decreasing by more than \$3 million between FY 2009 and FY 2013. These types of contracts involve the purchase of assessment and/or treatment services for substance abuse, child sex abuse, and mental health, as well as domestic violence emergency shelter services, juvenile client and family services, victim impact classes, individual/group counseling, and more. Portions of some of these programs/services were reduced or eliminated resulting, in some cases, in less services being available, less clients being served, and longer waits to access services. The Judiciary is very appreciative that the Legislature recognized this situation and provided more than \$900,000 in funding in FYs 2014 and 2015 to restore some of the POS funding cuts, and additional one-time funding of \$600,000 in FY 2016, \$750,000 in FY 2017, \$450,000 in FY 2019, and \$500,000 in FY 2020 specifically for civil legal services. Actual POS contract expenditures totaled \$9.5 million in FY 2019, some \$2.5 million less than they were in FY 2009 and \$1.5 million less than the \$11 million projected for FY 2019. Expenditures were less than projected for various reasons including lack of a provider for specified services (e.g., two POS contracts projected at \$61,000 in Second Circuit with no providers bidding) and staffing shortages by providers limiting their services (e.g., three POS contracts in Second Circuit projected at \$1,059,000 with actual expenditures totaling just \$753,000).

Grant-in-aid funding totaled \$1.2 million in FY 2014 and \$1.3 million in FY 2015, but was only \$90,000 in FY 2016 and zero in FYs 2017, 2018, and 2019. In FY 2020, \$150,000 was provided for one organization. While the general reduction in overall grant funding does not directly affect the Judiciary as the Judiciary is more of a pass through agent for grants-in-aid, the absence of grant funding does affect those organizations that partly rely on such funds to operate and provide needed services to their target population.

It should be noted that in spite of the various funding and resource challenges faced by the Judiciary over the past few years, providing the public with greater access to justice and its civil and criminal justice systems continues to be a major emphasis for the Judiciary. This can take many different forms whether it be through its interpreter program, self-help centers and access to justice rooms, unbundling, the court navigator program, technology, and various types of specialty courts. For example, the Judiciary currently has more than 400 interpreters in its Court Interpreter Certification Program, provides interpreter services in 50 different languages/dialects, and interpreted more than 11,000 proceedings in FY 2018. Further, it is in the process of translating court forms from English into the 10 languages most frequently encountered in State courts, and its website provides information in 14 languages other than English. The Judiciary also now has 12 Hawaiian language interpreters that have completed the Basic Orientation Workshop, calls all Hawai'i Supreme Court and Intermediate Court of Appeals cases in both Hawaiian and English, and is working with Kapi'olani Community College to translate the Judiciary's Language ID Card and "How to Request an Interpreter" sheet into Hawaiian.

The Judiciary has also established self-help centers ("access to justice rooms") in each circuit where volunteer attorneys are available to provide information on civil matters to self-represented litigants. Since the first self-help center was opened on Kaua'i in 2011, almost 27,000 of these litigants have been assisted. Further, in September 2019, the Hawai'i Supreme Court issued orders allowing for the unbundling of legal services in Hawai'i's courts. In recent years, 97% of summary possession cases and 94% of divorce cases in Hawai'i involve at least one party without an attorney; in fact, in divorce cases, both parties represent themselves 62% of the time. The primary reason for this is the cost of counsel even though most litigants would prefer the assistance of a lawyer. Rules for unbundling now provide that lawyers can limit their work to certain parts of a case while clients retain responsibility for other parts. For example, a litigant may hire a lawyer for only a contentious custody portion of a divorce. This reduces costs to litigants and increases court efficiency through fewer court appearances and delays as litigants are better prepared to present their cases.

Other access to justice programs and/or accomplishments include the Hawai'i Appellate Mediation Program (AMP) and the Volunteer Court Navigator Program. Since its inception in 1995, AMP, which focuses on civil cases on appeal and matches income-qualifying litigants with attorneys willing to provide legal services without charge, has handled more than 720 cases with over half of them resulting in settlements. The Volunteer Court Navigator Program was established on Maui in June 2018. Under this Program, the Judiciary stations volunteer court navigators on various floors in the courthouse to assist self-represented litigants when they come to the courthouse. Navigators have served more than 700 people and been present at every debtor-creditor, landlord-tenant, and non-family TRO court session since this Program began.

The Judiciary's use of technology also enhances access to justice. Its award winning court website has been recognized for improved communication, operational efficiencies, and access to justice, especially for self-represented litigants and those with limited English proficiency, while its free Courts Mobile App provides a wealth of information about Hawaii's courts. Criminal, appellate, and civil cases (except civil family cases) all now have the convenience of e-filing which allows cases to be initiated online and court documents to be electronically filed 24 hours a day. Also, in late 2018, the eReminder Service Project, which sends electronic reminders about court hearings to criminal defendants, was launched and offered to all defendants that had traffic cases, or circuit, district, or family court criminal cases. Interested persons enrolled by filling out an application. Through August 2019, 15,511 texts had been sent to 2,031 subscribers.

Specialty courts and programs are another facet of access to justice as these programs focus on certain targeted individuals or conditions. For example, Drug Court programs, which are 18 months of intensive outpatient substance abuse treatment, have been established on all islands. These programs have graduated 2,100 people since the first Drug Court was established on O‘ahu in 1996. Veterans Treatment Courts, the first of which was established on O‘ahu in 2013, are now on all islands and have graduated 42 participants to date. Truancy court programs, which have recently been established on O‘ahu, Hawai‘i, and Kaua‘i, address chronic absenteeism and truancy problems, which have been identified as one of the early signs of delinquent activity among young people. Hawai‘i launched one of the nation’s first Girls Court models in 2004 to provide gender-responsive programs and services that target at-risk and delinquent girls or boys who identify as female. Some 240 youth and 277 family members have received assistance from Girls Court.

In January 2017, the Judiciary, in collaboration with the Department of the Prosecuting Attorney of the City and County of Honolulu, and the Office of Public Defender, State of Hawai‘i, started the Community Outreach Court with grant and subsequent legislative funding. The target population for this Outreach Court is nonviolent offenders, primarily homeless, who often face problems (such as drug abuse and mental health challenges) in obtaining basic services and necessities, like food and shelter, and connecting these people to those that can help with shelter/housing, health services, identification documents, and employment. Among this Court’s objectives are to relocate services closer to the community and help clear minor quality-of-life offenses and bench warrants. Court sessions have been held in Honolulu District Court, Wahiawā District Court, Wai‘anae Public Library, and Kāne‘ohe District Court, generally once a month except in Honolulu where it is twice monthly. As of September 30, 2019, 101 Community Court Outreach sessions have been held, 201 persons have participated in the program, 2,321 cases have been cleared, and almost 4,000 hours of community service have been performed by these participants.

Lastly, access to justice has been significantly improved for West Hawai‘i residents with the on-time, on budget completion of the new Keahuolū Courthouse in Kona, which opened in September 2019. These residents now have all court services available under one roof at one location in a modern, technologically improved and advanced facility as opposed to the previous situation where courts were located in non-court buildings at three separate locations distant from each other.

PERFORMANCE MEASUREMENT: In comparing the median age for disposition for circuit court cases in FY 2019 with FY 2018 and FY 2009 (before the budget and personnel reductions that occurred during the recession), it is noted that the median age for criminal cases in each circuit has increased from FY 2009, except for Third Circuit where there has been a significant decrease. For civil cases, the median time has also substantially increased in each circuit since FY 2009, primarily due to the effect of the increase in foreclosure filings during the recession, especially in FYs 2011, 2012, and 2013; the time necessary to dispose of these cases; and the review and clean-up of very old cases in the system. Specifically, for First Circuit, the median time went from 265 to 377 to 366 days for the three fiscal years [this is, FYs 2009, 2018, and 2019] for criminal cases, and from 393 to 604 to 601 days for civil cases. For Second Circuit, the median time was 231 to 252 days to 274 for criminal cases and 294 to 541 to 557 days for civil cases. For Third Circuit, the median time for criminal cases went from 301 to 176 to 175 days and civil cases went from 298 to 577 days both in FYs 2018 and 2019. Lastly, for Fifth Circuit, criminal cases went from 307 to 329 to 376 days and civil cases from 400 to 1,660 to 732 days, quite a significant reduction.

The clearance rate/disposition rate (number of cases terminated or disposed divided by number of new filings) is another performance measure that can be looked at. The Intermediate Court of Appeals had a disposition rate of 102% in FY 2019, which is a significant increase over the 83% rate in FY 2017 and the 85%

rate in FY 2018. The clearance rates for Circuit, Family, and District Court cases (excluding parking cases) of 90.7%, 92.9%, and 127% in FY 2019 were also notably higher than the 84.8%, 87.7%, and 103.1% rates in FY 2018 and the 76.1%, 92.1%, and 110.5% rates in FY 2009.

FEDERAL FUNDS: The Judiciary is unaware of and has not identified any programs that are at risk for losing federal funds.

BUDGET REQUEST: In late July each year, the Budget Office prepares and distributes a Budget Instruction package to its programs, requesting them to provide their budget requests and associated write-ups to the Budget Office by early September. The Chief Justice and Administrative Director of the Courts are also asked to provide information as to any specific items or other guidance that the Budget Office might want to focus on or consider. Once the budget support packages are received from the programs, the Budget Office reviews them, requests further information from the programs as necessary, and then makes a preliminary determination as to which requests are supportable, adequately justified, and the Judiciary should go forward with. These requests, along with those not recommended, are reviewed with the Administrative Director and the Chief Justice and a final decision is made as to which items should be part of the Judiciary's budget request. The programs prioritize their requests when they submit them to the Budget Office. However, once the final decision is made as to which budget request items to submit to the Legislature, the Budget Office, in conjunction with the Administrative Director of the Courts and the Chief Justice, prioritizes the requests Judiciary-wide.

With regard to our budget requests for the supplemental period, we, as mentioned earlier, are very cognizant that there are many issues and concerns that must be addressed by the legislature, and that funds will continue to be tight during this supplemental year. Accordingly, the Judiciary has a very modest supplemental budget request for just seven new permanent positions and funding of \$1.23 million for FY 2021, which is only 0.7 percent of the Judiciary's current budget. Three of these position requests are for no-cost conversions of temporary to permanent positions – two social workers for the Court Appointed Special Advocates Program in the First Circuit to help stabilize the program and provide programmatic assistance and advocacy for abused and neglected children, and one for a court operations specialist in Courts of Appeal. Stability for the court operations specialist position is necessary to provide continuity, knowledge, and familiarity in building management and maintenance issues for Ali'iōlani Hale and Kapuāiwa Buildings, both of which are over 150 years old and on the National Register of Historic Places.

The remaining four new permanent positions being requested are for a District Court judge and three support staff positions in the Second Circuit where the county population has more than doubled since the last district court judge position was added in 1982. A new judge would allow the Second Circuit to consider implementing additional court dockets and programming to meet needs of individuals struggling with homelessness or mental health issues; expand court services in Lahaina to five days per week; and expand services in Hāna, and on Moloka'i and Lāna'i.

The Judiciary has only two other general fund requests – one to fund the \$2,000 annual salary increase per judge based on the recommendation from the 2019 Commission on Salaries, and the second for continuous civil legal services funding for low-income individuals rather than have it periodically provided on a one-time basis by the Legislature. As mentioned earlier in this document, such funding has been provided in varying amounts over the past number of years, except for FY 2018.

Capital Improvement Project (CIP) requirements remain a major item of concern as the Judiciary's infrastructure continues to age and deteriorate, and as the population served and services provided by the

Judiciary keep expanding. CIP funds totaling \$27.7 million are being requested to address certain critical needs, some of which relate to the health and safety of Judiciary employees and the public. Specifically, the Judiciary is requesting funds to upgrade and modernize fire alarm systems and elevators at Ka'ahumanu Hale (First Circuit), both of which are more than 30 years old, are tied into each other, and which continue to malfunction with greater frequency; to renovate the Ka'ahumanu Hale sheriff station; and to continue on-going projects to renovate piping at the Hoapili Hale parking structure (Second Circuit) and to reroof and repair leaks and resulting damages at Pu'uhonua Kaulike (Fifth Circuit). Lastly, CIP lump sum funding is being requested so that we can address both continuing and emergent building issues statewide.

In sum, the Judiciary recognizes the State still has important fiscal concerns even in this relatively stable economy, and that balancing the desire to continue to provide adequate public services to Hawaii's citizens against competing initiatives with available general fund resources creates difficult allocation decisions. We believe that the additional amount being requested for this supplemental year is a relatively modest amount to enhance court and client services, and to serve some of those clients most in need of these services.

This concludes the overview section of our testimony. It should be noted that the tables requested by the December 2019 Supplemental Briefing Instructions follow this overview section.



**January 2020
The Judiciary
FY 2021 Supplemental Budget**

ACCESS TO JUSTICE

- Support for People with Limited English Proficiency
 - Interpreters
 - Website Information in Other Languages
 - Translation of Court Forms from English
- Support for Self-Represented Litigants
 - Self-Help Counters / Access to Justice Rooms
 - Unbundling
 - Hawaii Appellate Mediation Program
 - Volunteer Court Navigator Program

ACCESS TO JUSTICE (CONT'D)

- Technology
 - Website
 - Mobile Application
 - E-filing
 - eReminder
- Specialty Courts
 - Drug Courts
 - Girls Court
 - Veterans Treatment Court
 - Truancy Court
 - Community Outreach Court
- Keahuolū Courthouse

**FY 2021
SUPPLEMENTAL BUDGET REQUESTS**

**FY 2021 SUPPLEMENTAL BUDGET REQUESTS
JUDICIARY SUMMARY
GENERAL FUNDS**

	REQUEST FY 2021	
JUDICIARY PROGRAM	POS CT: PERM / TEMP	AMOUNT
Courts of Appeal	1.00 / (1.00)	44,000
First Circuit	2.00 / (2.00)	220,000
Second Circuit	4.00 / 0.00	392,856
Third Circuit	0.00 / 0.00	48,000
Fifth Circuit	0.00 / 0.00	24,000
Judicial Selection Commission	0.00 / 0.00	0
Administration	0.00 / 0.00	500,000
JUDICIARY TOTAL	7.00 / (3.00)	1,228,856

SUPPLEMENTAL BUDGET REQUESTS

Overall, 5 requests for 7 permanent positions and funding of \$1.23 million in FY 2021.

- Essential Staffing: Court/Administrative Operations (\$353K)
 - District Court Judge and Staff (4) – Second Circuit (\$353K)
 - Court Ops Specialist Position Conversion (1) – Courts of Appeal (\$0)
- Client Services
 - CASA Social Worker Position Conversions (2) – First Circuit (\$0)
 - Civil Legal Services – Administration (0) (\$500K)
- Judges' Salary Increase (\$376K)

JUDICIARY CIP REQUESTS

<u>Circuit</u>	<u>Description</u>	<u>FY 2021</u>
1st	Ka'ahumanu Hale Fire Alarm Systems/ Elevator Upgrade [C]	17,550,000
1st	Ka'ahumanu Hale Sheriff Station Renovation [D], [C]	1,700,000
2nd	Hoapili Hale Parking Structure Piping Renovations [D], [C]	2,800,000
5th	Reroof and Repair Leaks/Damages - Kauai Courthouse [C]	2,650,000
Admin	Lump Sum CIP	3,000,000
	Total	<u>27,700,000</u>

Judiciary
Functions

Table 1

<u>Division</u>	<u>Description of Function</u>	<u>Activities</u>	<u>Prog ID(s)</u>	<u>Statutory Reference</u>
Supreme Court	The Supreme Court is the State of Hawaii's court of last resort, and hears appeals on transfer from the Intermediate Court of Appeals or on writ of certiorari to the Intermediate Court of Appeals. It licenses and disciplines attorneys, disciplines judges, and exercises ultimate rule-making power for all courts in the State.	The Supreme Court hears and makes determinations on appeals and original proceedings that are properly brought before the court, including cases heard upon applications for writs of certiorari; cases transferred from the Intermediate Court of Appeals; reserved questions of law from the Circuit Courts, the Land Court, and the Tax Appeal Court; certified questions of law from federal courts; applications for writs directed to judges and other public officers; and complaints regarding elections.	JUD 101	Article VI of the Hawaii State Constitution HRS Section 602
Intermediate Court of Appeals	The Intermediate Court of Appeals reviews, in the first instance, appeals from trial courts and from some agencies. It is also authorized to entertain cases submitted without suit when there is a question of law that could be the subject of a civil suit in the Circuit Court or the Tax Appeal Court, and the parties agree upon the facts upon which the controversy depends.	The Intermediate Court of Appeals provides timely disposition of appeals from trial courts and state agencies, including the resolution of the particular dispute and explication of the law for the benefit of the litigants, the bar, and the public.	JUD 101	Article VI of the Hawaii State Constitution HRS Section 602
Lower Courts Adjudication	Adjudication provides the First, Second, Third, and Fifth Circuits with judges and staff to operate the Circuit, Family, and District Courts.	Central to the operation of the lower court programs of the Judiciary are the Circuit Courts, Family Courts (a division of the Circuit Court), and District Courts.	JUD 310 JUD 320 JUD 330 JUD 350	Article VI of the Hawaii State Constitution HRS Section 603 HRS Section 604

Judiciary
Functions

Table 1

<u>Division</u>	<u>Description of Function</u>	<u>Activities</u>	<u>Prog ID(s)</u>	<u>Statutory Reference</u>
Lower Courts Central Administration	The primary objectives of the programs in each circuit include providing for effective and efficient planning, direction, administration, coordination, and evaluation of all administrative business and support functions, operations, and activities required to support judicial proceedings and judgments in the Circuit, District, and Family Courts.	Circuit Courts are trial courts of general jurisdiction. Circuit Courts have jurisdiction in most felony cases, and concurrent jurisdiction with the Family Courts for certain felonies related to domestic abuse, such as violations of temporary restraining orders involving family and household members. Circuit Courts also have exclusive jurisdiction in probate, trust, and conservatorship (formerly "guardian of the property") proceedings, and concurrent jurisdiction with the Family Courts over adult guardianship (formerly "guardian of the person") proceedings. Circuit Courts have exclusive jurisdiction in civil cases involving amounts greater than \$40,000, and concurrent jurisdiction with District Courts in civil cases involving amounts between \$10,000 and \$40,000. Jury trials are conducted exclusively by Circuit Court judges. A party to a civil case triable by jury may demand a jury trial where the amount in controversy exceeds \$5,000. Circuit Courts have exclusive jurisdiction in mechanics lien cases and foreclosure cases, and jurisdiction as provided by law in appeals from other agencies (such as unemployment compensation appeals).	JUD 310 JUD 320 JUD 330 JUD 350	Article VI of the Hawaii State Constitution HRS Section 603 HRS Section 604
Lower Courts Client Services	The primary objective is to provide direct services to adult and juvenile clients of courts within the First, Second, Third, and Fifth Circuits. Activities include making recommendations to the courts, enforcing compliance with court orders, maintaining client classification and information systems, managing purchase of service contracts, and maintaining contacts with community resources.	Circuit Court programs include alternatives to traditional dispute resolution methods. The Circuit Court Drug Court Programs aim to divert nonviolent defendants from the traditional criminal justice path and incarceration, placing them in treatment programs under judicial supervision, rewarding good behavior, and imposing immediate sanctions for relapse into drug use. The Circuit Court's Court Annexed Arbitration Program is designed to reduce the cost and delay of protracted civil litigation, requiring tort actions with a probable jury award value under \$150,000 to be submitted to the program and be subject to a determination of arbitrability and to arbitration under program rules.	JUD 310 JUD 320 JUD 330 JUD 350	Article VI of the Hawaii State Constitution HRS Section 603 HRS Section 604

Judiciary
Functions

Table 1

<u>Division</u>	<u>Description of Function</u>	<u>Activities</u>	<u>Prog ID(s)</u>	<u>Statutory Reference</u>
Lower Courts Court Services	Court Services are responsible for providing courtroom clerical, court reporting, and other support and ancillary services to the courts of the First, Second, Third, and Fifth Circuits. Programs are designed to aid in the timely disposition of cases of general and limited jurisdiction for civil, criminal felonies, misdemeanors, petty misdemeanors, family proceedings, and traffic (decriminalized and regular traffic criminal) in each circuit.	The Family Courts, divisions of the Circuit Courts, are specialized courts of record designed to deal with family conflict and juvenile offenders. The Family Court complements its strictly adjudicatory functions by providing a number of counseling, guidance, detention, mediation, education, and supervisory programs for children and adults. The Family Courts retain jurisdiction over children who, while under the age of 18, violate any law or ordinance, are neglected or abandoned, are beyond the control of their parents or other custodians, live in an environment injurious to their welfare, or behave in a manner injurious to their own or others' welfare. Activities are geared toward facilitating the determination of the court for appropriate and timely dispositions; preparing cases for detention, adjudicatory, and dispositional hearings; conducting social study investigations; and supervising and treating juveniles under legal status with the court. Family Court activities also include Foster Home placement and providing guardians ad-litem.	JUD 310 JUD 320 JUD 330 JUD 350	Article VI of the Hawaii State Constitution HRS Section 603 HRS Section 604
Lower Courts Court Services		The Family Court's jurisdiction also encompasses adults involved in offenses against other family members; dissolution of marriages; disputed child custody and visitation issues; resolution of paternity issues; adoptions; and adults who are incapacitated and/or are in need of protection. The Family Courts provide services which include temporary restraining orders for protection; treatment of parties involved in domestic violence; supervision and monitoring of defendants in domestic abuse cases; and education programs for separating parents and children.	JUD 310 JUD 320 JUD 330 JUD 350	Article VI of the Hawaii State Constitution HRS Section 603 HRS Section 604

Judiciary
Functions

Table 1

<u>Division</u>	<u>Description of Function</u>	<u>Activities</u>	<u>Prog ID(s)</u>	<u>Statutory Reference</u>
Lower Courts Court Services		The District Courts are the courts with which the citizens of Hawai'i most frequently come into contact. In the First Circuit, courthouses in the four rural judicial districts of Ewa/Pearl City, Waianae, Wahiawa, and Kaneohe provide residents with the option of conveniently staying within their respective communities to transact many types of court business. The District Courts, in civil matters, exercise jurisdiction where the amount in controversy does not exceed \$40,000. If the amount in controversy exceeds \$5,000, the parties may demand a jury trial, in which case the matter is committed to the Circuit Courts. The District Courts also have exclusive jurisdiction in all landlord-tenant cases and all small claims actions (suits in which the amount in controversy does not exceed \$5,000). The civil divisions of the District Courts also handle temporary restraining orders and injunctions against harassment for non-household members.	JUD 310 JUD 320 JUD 330 JUD 350	Article VI of the Hawaii State Constitution HRS Section 603 HRS Section 604
Office of the Administrative Director	The Office of the Administrative Director primarily assists the Chief Justice in directing the administration of the Judiciary and in examining the administrative methods of the courts to determine and make recommendations to the Chief Justice for their improvement. It also administers statewide programs and activities relating to personnel management; planning and budget; fiscal; compilation and analysis of statistical data and reports; information and data processing; public information and dissemination; and facilities planning and maintenance. Relative to these programs and activities, the Office of the Administrative Director provides direction to the respective Chief Court Administrators, Administrative Department Heads, and other managers. It also has direct oversight over the Administration Fiscal Office.	The Office of the Administrative Director of the Courts serves as the administrative arm of the Judiciary. It is headed by an Administrative Director who is appointed by the Chief Justice with the approval of the Supreme Court. The Administrative Director is assisted by a Deputy Administrative Director of the Courts in fulfilling the duties and responsibilities assigned to the office. The Director's Office is composed of a number of staff and specific programs.	JUD 501 JUD 601	Article VI of the Hawaii State Constitution HRS Section 601 HRS Section 6F HRS Section 551A HRS Section 588 HRS Section 613

Judiciary
Functions

Table 1

<u>Division</u>	<u>Description of Function</u>	<u>Activities</u>	<u>Prog ID(s)</u>	<u>Statutory Reference</u>
Office of the Administrative Director		The Intergovernmental and Community Relations Department provides legal services, public relations, and information services for the Judiciary; coordinates citizen volunteer services and investigative processes in cases of intrafamilial and extrafamilial child sex abuse; researches, plans, and develops alternate dispute resolution procedures and programs; and provides educational programs using a variety of interpretive media that promote understanding and appreciation of the history of Hawaii's Judiciary. This Department is also concerned with providing public guardianship for mentally incapacitated adults; promoting equality and accessibility in the State's justice system; conducting equal employment opportunity (EEO) training and discrimination investigations; and providing legal reference resources and services to the courts, the legal community, and the public.	JUD 601	Article VI of the Hawaii State Constitution HRS Section 601 HRS Section 6F HRS Section 551A HRS Section 588 HRS Section 613
Office of the Administrative Director		The planning, program evaluation, budgeting, capital improvement, statistics, audit, and legislative coordination functions are carried out by the Policy and Planning Department. The financial, purchasing, and administrative drivers license revocation branches are managed by the Financial Services Department. The data processing, reprographics, telecommunications, and records management functions are performed within the Information Technology (IT) and Systems Department. The Human Resources Department manages centralized programs of recruitment, compensation, record keeping, employee and labor relations, employee benefits, and continuing education.	JUD 601	Article VI of the Hawaii State Constitution HRS Section 601 HRS Section 6F HRS Section 551A HRS Section 588 HRS Section 613
Office of the Administrative Director		The Commission on Judicial Conduct, which is attached to the Judiciary for administrative purposes only, is responsible for investigating allegations of judicial misconduct and disability. Rules of the court require that three licensed attorneys and four citizens who are not attorneys be appointed to this Commission. The Commission is also allowed to issue advisory opinions to aid judges in the interpretation of the Code of Judicial Conduct.	JUD 601	Article VI of the Hawaii State Constitution HRS Section 601 HRS Section 6F HRS Section 551A HRS Section 588 HRS Section 613

Judiciary
Functions

Table 1

<u>Division</u>	<u>Description of Function</u>	<u>Activities</u>	<u>Prog ID(s)</u>	<u>Statutory Reference</u>
Office of the Administrative Director		The Judicial Selection Commission, which is attached to the Judiciary for administrative purposes only, is responsible for reviewing applicants for judgeships in Hawai'i courts and submitting a list of six nominees to the appointing authority for each vacancy. The Governor, with the consent of the Senate, appoints justices to the Supreme Court and judges to the Intermediate Court of Appeals and Circuit Court. The Chief Justice appoints and the Senate confirms District Court and District Family Court judges. The Commission has sole authority to act on reappointments to judicial office.	JUD 501	Article VI of the Hawaii State Constitution HRS Section 601 HRS Section 6F HRS Section 551A HRS Section 588 HRS Section 613
Office of the Deputy Administrative Director	The Office of the Deputy Administrative Director of the Courts assists the Administrative Director of the Courts in the administration of the Judiciary through subordinate administrators/managers.		JUD 601	Article VI of the Hawaii State Constitution HRS Section 601 HRS Section 6F HRS Section 551A HRS Section 588 HRS Section 613
Inter-governmental and Community Relations	The Intergovernmental and Community Relations Department plans, directs, and coordinates the operations and activities of the various programs within the department through subordinate program managers, and supervisors. Programs in this unit include: staff attorneys, public information, alternative dispute resolution, volunteers in public service, equality and access to the courts, children's justice advocacy, public guardian, Judiciary History Center, EEO/affirmative action, and the law library.		JUD 601	Article VI of the Hawaii State Constitution HRS Section 601 HRS Section 6F HRS Section 551A HRS Section 588 HRS Section 613
Policy and Planning	The Policy and Planning Department plans, directs, and coordinates the operations and activities of the various programs within the department through subordinate program managers, and supervisors. Programs in this unit include: budget, capital improvements, planning and program evaluation, internal audit, statistics, and legislative coordination / special projects.		JUD 601	Article VI of the Hawaii State Constitution HRS Section 601 HRS Section 6F HRS Section 551A HRS Section 588 HRS Section 613

Judiciary
Functions

Table 1

<u>Division</u>	<u>Description of Function</u>	<u>Activities</u>	<u>Prog ID(s)</u>	<u>Statutory Reference</u>
Financial Services	The Financial Services Department plans, directs, and coordinates the operations and activities of the various programs within the department through subordinate program managers, and supervisors. Programs in this unit include: financial and support services (including contracts and purchasing), and the administrative drivers license revocation office.		JUD 601	Article VI of the Hawaii State Constitution HRS Section 601 HRS Section 6F HRS Section 551A HRS Section 588 HRS Section 613
IT and Systems	The IT and Systems Department plans, directs, and coordinates the operations and activities of the various programs within the department through subordinate program managers, and supervisors. Programs in this unit include: applications division, infrastructure division (1), infrastructure division (2), and the Documents Management Division.		JUD 601	Article VI of the Hawaii State Constitution HRS Section 601 HRS Section 6F HRS Section 551A HRS Section 588 HRS Section 613
Human Resources	The Human Resources Department plans, directs, and coordinates the operations and activities of the various programs within the department through subordinate program managers and supervisors. Programs in this unit include: administrative services, labor relations, compensation management, staffing services, disability claims management, employee services, and judicial / employee training and development.		JUD 601	Article VI of the Hawaii State Constitution HRS Section 601 HRS Section 6F HRS Section 551A HRS Section 588 HRS Section 613

Judiciary
Department-Wide Totals

Table 2

Fiscal Year 2020					
Budget Acts Appropriation	Reductions	Additions	Emergency Appropriations	Total FY20	MOF
				\$ -	
\$ 171,819,204.00				\$ 171,819,204.00	A
\$ 12,463,914.00				\$ 12,463,914.00	B
\$ 343,261.00				\$ 343,261.00	W
				\$ -	
				\$ -	
\$ 184,626,379.00	\$ -	\$ -	\$ -	\$ 184,626,379.00	Total
Fiscal Year 2021					
Budget Acts Appropriation	Reductions	Additions		Total FY21	MOF
				\$ -	
\$ 171,496,990.00		\$ 1,228,856.00		\$ 172,725,846.00	A
\$ 12,463,914.00				\$ 12,463,914.00	B
\$ 343,261.00				\$ 343,261.00	W
				\$ -	
				\$ -	
\$ 184,304,165.00	\$ -	\$ 1,228,856.00	\$ -	\$ 185,533,021.00	Total

Judiciary
Program ID Totals

Table 3

Prog ID	Program Title	MOF	As budgeted (FY20)			As budgeted (FY21)			Judiciary Submittal (FY20)				Judiciary Submittal (FY21)						
			Pos (P)	Pos (T)	\$\$\$	Pos (P)	Pos (T)	\$\$\$	Pos (P)	Pos (T)	\$\$\$	Percent Change of \$\$\$\$	Pos (P)	Pos (T)	\$\$\$	Percent Change of \$\$\$\$			
												#DIV/0!				#DIV/0!			
JUD 101	Courts of Appeal	A	73.00	1.00	\$ 7,216,185	73.00	1.00	\$ 7,216,185	73.00	1.00	\$ 7,216,185	0.00%	75.00	1]	0.48	1]	\$ 7,313,592	1]	1.35%
JUD 310	First Circuit	A	1,103.50	58.58	\$ 88,278,054	1,103.50	58.58	\$ 88,425,760	1,103.50	58.58	\$ 88,278,054	0.00%	1,104.50	2]	56.58	2]	\$ 88,602,752	2]	0.20%
		B	41.00	-	\$ 4,429,112	41.00	-	\$ 4,429,112	41.00	-	\$ 4,429,112	0.00%	41.00		-		\$ 4,429,112		0.00%
JUD 320	Second Circuit	A	210.50	1.68	\$ 17,949,998	210.50	1.68	\$ 17,955,448	210.50	1.68	\$ 17,949,998	0.00%	214.50		1.68		\$ 18,348,304		2.19%
JUD 330	Third Circuit	A	240.00	5.68	\$ 21,729,887	240.00	5.68	\$ 21,761,042	240.00	5.68	\$ 21,729,887	0.00%	240.00		5.20	3]	\$ 21,798,643	3]	0.17%
JUD 350	Fifth Circuit	A	103.00	2.60	\$ 8,455,480	103.00	2.60	\$ 8,447,902	103.00	2.60	\$ 8,455,480	0.00%	103.00		2.60		\$ 8,471,902		0.28%
JUD 501	Judicial Selection Commission	A	1.00	-	\$ 103,414	1.00	-	\$ 103,414	1.00	-	\$ 103,414	0.00%	1.00		-		\$ 103,414		0.00%
JUD 601	Administration	A	226.00	9.48	\$ 28,086,186	226.00	9.48	\$ 27,587,239	226.00	9.48	\$ 28,086,186	0.00%	226.00		9.48		\$ 28,087,239		1.81%
		B	1.00	9.00	\$ 8,034,802	1.00	9.00	\$ 8,034,802	1.00	9.00	\$ 8,034,802	0.00%	1.00		9.00		\$ 8,034,802		0.00%
		W	-	-	\$ 343,261	-	-	\$ 343,261	-	-	\$ 343,261	0.00%	-		-		\$ 343,261		0.00%
		A	1,957.00	79.02	\$ 171,819,204	1,957.00	79.02	\$ 171,496,990	1,957.00	79.02	\$ 171,819,204	0.00%	1,964.00		76.02		\$ 172,725,846		0.72%
		B	42.00	9.00	\$ 12,463,914	42.00	9.00	\$ 12,463,914	42.00	9.00	\$ 12,463,914	0.00%	42.00		9.00		\$ 12,463,914		0.00%
		W	-	-	\$ 343,261	-	-	\$ 343,261	-	-	\$ 343,261	0.00%	-		-		\$ 343,261		0.00%
1] Reflects transfer in of 1.00 FTE permanent position and \$43,008 from First Circuit Court and transfer in of 0.48 FTE temporary position and \$10,399 from Third Circuit Court.																			
2] Reflects transfer out of 1.00 FTE permanent position and \$43,008 to Courts of Appeal.																			
3] Reflects transfer out of 0.48 FTE temporary position and \$10,399 to Courts of Appeal.																			

Judiciary
Budget Decisions

Prog ID	Sub-Org	Description of Request	MOF	Initial Department Requests						Budget and Finance Recommendations						Governor's Decision					
				FY20			FY21			FY20			FY21			FY20			FY21		
				Pos (P)	Pos (T)	\$\$\$	Pos (P)	Pos (T)	\$\$\$	Pos (P)	Pos (T)	\$\$\$	Pos (P)	Pos (T)	\$\$\$	Pos (P)	Pos (T)	\$\$\$	Pos (P)	Pos (T)	\$\$\$
N/A																					

Judiciary
Proposed Budget Reductions

Table 5

Prog ID	Sub-Org	Description of Reduction	Impact of Reduction	MOF	FY20			FY21			FY19 Restriction (Y/N)
					Pos (P)	Pos (T)	\$\$\$\$	Pos (P)	Pos (T)	\$\$\$\$	
None											

Judiciary
Proposed Budget Additions

Table 6

Prog ID	Sub-Org	Addition Type	Prog ID Priority	Dept-Wide Priority	Description of Addition	Justification	MOF	FY20			FY21		
								Pos (P)	Pos (T)	\$\$\$	Pos (P)	Pos (T)	\$\$\$
ALL		FC		1	Judges salary differential	To fund Justices' and Judges' salaries at the legislatively mandated pay levels set by the 2019 Commission on Salaries and authorized by the 2019 Legislature.	A	-	-	\$ -	-	-	\$ 376,000
JUD320		AR		2	District Court Judge and support staff	Additional District Judge and 3 support staff to handle increased workload; last District Judge added in 1982. Increase Lahaina District Court from 3-day a week to 5-day a week rural calendar; address growing judicial needs of rural communities (Hana, Lanai & Molokai); and provide for implementation of a mental health docket, DUI Treatment court and COC to help those struggling with homelessness.	A	-	-	\$ -	4.00	-	\$ 352,856
JUD601		AR		3	Civil Legal Services	To establish permanent funding. In the past, the Judiciary received one-time funding of \$500K (FY20); \$450K (FY19); \$0 (FY18); \$750K (FY17)	A	-	-	\$ -	-	-	\$ 500,000
JUD310				4	No cost conversion of two temporary Court Appointed Special Advocate Social Worker positions to permanent status	Permanent staffing essential to meet all program's functions and maintain legal and national certification standards.	A	-	-	\$ -	2.00	-2.00	\$ -
JUD101				5	No cost conversion of one temporary Court Operations Specialist Position to permanent status	Permanent staffing needed to perform building management duties for Aliiolani Hale and Kapuaiwa Buildings, both of which are almost 150 years old.	A	-	-	\$ -	1.00	-1.00	\$ -
							A	-	-	\$ -	7.00	-3.00	\$ 1,228,856

Judiciary
 FB 2017 - 2020 Restrictions

Table 7

<u>Fiscal Year</u>	<u>Prog ID</u>	<u>Sub-Org</u>	<u>MOF</u>	<u>Budgeted by Dept</u>	<u>Restriction</u>	<u>Difference Between Budgeted & Restricted</u>	<u>Percent Difference</u>	<u>Impact</u>
None								

Judiciary
Emergency Appropriation Requests

Table 8

<u>Prog ID</u>	<u>Description of Request</u>	<u>Explanation of Request</u>	<u>MOF</u>	<u>Pos (P)</u>	<u>Pos (T)</u>	<u>\$\$\$</u>
None						

Expenditures Exceeding Appropriation Ceilings in FY19 and FY20

<u>Prog ID</u>	<u>MOF</u>	<u>Date</u>	<u>Appropriation</u>	<u>Amount Exceeding Appropriation</u>	<u>Percent Exceeded</u>	<u>Reason for Exceeding Ceiling</u>	<u>Legal Authority</u>	<u>Recurring (Y/N)</u>	<u>GF Impact (Y/N)</u>
None									

Judiciary
Intradepartmental Transfers in FY19 and FY20

<u>Actual or Anticipated Date of Transfer</u>	<u>MOF</u>	<u>Pos (P)</u>	<u>Pos (T)</u>	<u>\$\$\$</u>	<u>From Prog ID</u>	<u>Percent of Program ID Appropriation Transferred From</u>	<u>To Prog ID</u>	<u>Percent of Receiving Program ID Appropriation</u>	<u>Reason for Transfer</u>	<u>Recurring (Y/N)</u>
3/19/2019	A			\$ 142,323	JUD 601	0.5%	JUD 310	0.2%	To reallocate funds budgeted to Administration to the respective circuits for expanded court interpreter services.	
			\$ 7,746	0.0%		JUD 320	0.0%			
			\$ 15,084	0.1%		JUD 330	0.1%			
			\$ 8,130	0.0%		JUD 350	0.1%			

Judiciary
Vacancy Report as of November 30, 2019

Table 11

Prog ID	Sub-Org	Date of Vacancy	Expected Fill Date	Position Number	Position Title	Exempt (Y/N)	SR Level	BU Code	Perm Temp (P/T)	FTE	MOF	Budgeted Amount	Actual Salary Last Paid	Authority to Hire (Y/N)	Occupied by 89 Day Hire (Y/N)	# of 89 Hire Appts	Describe if Filled by other Means	Priority # to Retain
General Fund																		
JUD 310		10/28/2019	3/1/20	500557	District Family Judge	Y	JG06	0	P	1.00	A	193,272	195,276	Y	N	0		1
JUD 310		10/28/2019	3/1/20	9836	District Judge	Y	JG06	0	P	1.00	A	193,272	195,276	Y	N	0		2
JUD 330		11/30/2019	3/31/20	203	Circuit Judge	Y	JG05	0	P	1.00	A	205,080	207,084	Y	N	0		3
JUD 350		7/19/2019	6/30/20	500856	District Family Judge	Y	JG06	0	P	1.00	A	193,272	N/A	Y	N	0		4
JUD 310		7/19/2019	6/30/20	500861	District Family Judge	Y	JG06	0	P	1.00	A	193,272	N/A	Y	N	0		5
JUD 310		11/30/2019	1/30/20	59229	Judicial Assistant I	Y	SR21	3	P	1.00	A	72,240	77,448	Y	N	0		6
JUD 330		11/30/2019	3/31/20	57200	Law Clerk	Y	SR20	73	P	1.00	A	62,480	62,004	Y	N	0		7
JUD 350		9/9/2019	2/1/20	500857	Circuit Court Clerk II	N	SR20	3	P	1.00	A	48,348	N/A	Y	N	0		8
JUD 350		9/9/2019	2/1/20	500858	Circuit Court Clerk II	N	SR20	3	P	1.00	A	48,348	N/A	Y	N	0		9
JUD 310		7/19/2019	3/31/20	500863	Circuit Court Clerk II	N	SR20	3	P	1.00	A	48,348	N/A	Y	N	0		10
JUD 310		7/19/2019	3/31/20	500864	Circuit Court Clerk II	N	SR20	3	P	1.00	A	48,348	N/A	Y	N	0		11
JUD 310		7/19/2019	3/31/20	500862	Court Bailiff II	N	SR15	3	P	1.00	A	39,720	N/A	Y	N	0		12
JUD 310		6/29/2019	3/4/20	14893	Social Services Manager	N	EM05	35	P	1.00	A	103,230	108,552	Y	N	0		13
JUD 320		6/29/2019	2/18/20	58156	Social Worker I	N	SR16	13	P	1.00	A	41,237	41,856	Y	N	0		14
JUD 320		8/27/2019	2/18/20	500451	Social Worker I	N	SR16	13	P	1.00	A	41,238	41,856	Y	N	0		15
JUD 601		3/5/2019	3/31/20	58062	Accountant VI	N	SR26	23	P	1.00	A	81,588	81,588	Y	N	0		16
JUD 601		12/29/2018	6/30/20	59206	IT Specialist VII	N	SR28	23	P	1.00	A	88,248	84,876	Y	N	0		17
JUD 601		1/23/2017	3/31/20	58065	IT Specialist VI	N	SR26	23	P	1.00	A	64,476	69,540	Y	N	0		18
JUD 601		12/29/2018	6/30/20	58297	IT Specialist VI	N	SR26	23	P	1.00	A	64,476	95,436	Y	N	0		19
JUD 101		1/16/2019	5/30/20	500071	Judicial Assistant II	Y	SR23	63	P	1.00	A	71,592	71,592	Y	N	0		20
JUD 310		7/6/2019	3/9/20	4765	Social Worker VI	N	SR26	23	P	1.00	A	69,247	75,432	Y	N	0		21
JUD 310		8/1/2019	4/27/20	5884	Social Worker VI	N	SR26	23	P	1.00	A	87,610	95,436	Y	N	0		22
JUD 310		3/18/2019	2/11/20	12718	Juvenile Detention Supervisor	N	CO09	20	P	1.00	A	68,442	73,560	Y	N	0		23
JUD 310		10/26/2019	3/1/20	59398	Attorney (PROGRAM) I	N	SR24	73	P	1.00	A	56,692	59,616	Y	N	0		24
JUD 310		9/1/2018	1/31/20	4717	Court Documents Supervisor	N	SR21	4	P	1.00	A	47,311	58,092	Y	N	0		25
JUD 330		10/26/2019	1/31/20	59613	Judicial Clerk II	N	SR12	3	P	1.00	A	48,719	35,340	Y	N	0		26
JUD 330		8/1/2019	3/30/20	57443	District Court Clerk II	N	SR17	3	P	1.00	A	48,719	48,348	Y	N	0		27
JUD 330		11/16/2019	2/28/20	57117	Court Documents Clerk III	N	SR19	3	P	1.00	A	54,850	50,304	Y	N	0		28
JUD 350		8/27/2019	4/1/20	500743	Social Worker IV	N	SR22	13	T	1.00	A	109,140	109,140	Y	N	0		29
JUD 601		8/16/2019	3/31/20	58738	CIP Coordinator	N	SR26	13	P	1.00	A	64,476	81,588	Y	N	0		30
JUD 601		11/16/2019	3/31/20	58934	Social Worker IV	N	SR22	13	P	1.00	A	55,092	55,092	Y	N	0		31
JUD 601		9/6/2018	3/31/20	59094	Social Worker V	N	SR24	23	P	1.00	A	64,476	72,528	Y	N	0		32
JUD 601		11/30/2019	4/1/20	500672	Human Resources Technician VI	N	SR15	63	T	1.00	A	39,720	50,304	Y	N	0		33
JUD 601		11/1/2019	3/1/20	500388	Account Clerk III	N	SR11	63	P	1.00	A	31,440	34,020	Y	N	0		34
JUD 320		11/16/2019	3/23/20	500185	Social Worker IV	N	SR22	13	P	1.00	A	56,478	57,324	Y	N	0		35
JUD 320		3/30/2019	3/30/20	57788	District Court Clerk II	N	SR17	3	P	1.00	A	60,273	61,176	Y	N	0		36
JUD 320		6/1/2019	3/30/20	58816	District Court Clerk II	N	SR17	3	P	1.00	A	57,955	58,824	Y	N	0		37
JUD 601		5/1/2019	2/28/20	500640	Purch & Specs Spclt V	N	SR24	13	T	1.00	A	32,664	46,476	Y	N	0		38
JUD 330		6/18/2019	2/28/20	57627	Account Clerk III	N	SR11	3	P	1.00	A	34,266	34,020	Y	N	0		39
JUD 330		5/7/2019	2/15/20	58657	Social Worker IV	N	SR22	13	P	1.00	A	53,362	57,324	Y	N	0		40
JUD 310		10/29/2019	1/31/20	57979	Circuit Court Clerk II	N	SR20	3	P	1.00	A	62,254	66,192	Y	N	0		41
JUD 310		8/12/2019	1/31/20	500045	Circuit Court Clerk I	N	SR17	3	P	1.00	A	43,711	46,476	Y	N	0		42
JUD 310		8/1/2019	3/1/20	4764	Ct Optns Spclt V	N	SR24	13	P	1.00	A	77,586	81,588	Y	N	0		43
JUD 310		6/29/2019	4/20/20	27567	Court Research Analyst	N	SR24	13	P	1.00	A	71,732	75,432	Y	N	0		44
JUD 310		4/19/2019	3/30/20	500831	Social Worker IV	N	SR22	13	P	1.00	A	48,614	52,956	Y	N	0		45
JUD 310		8/5/2019	2/11/20	58555	Social Worker IV	N	SR22	13	P	1.00	A	69,247	75,432	Y	N	0		46
JUD 350		1/1/2019	3/1/20	59467	Judicial Clerk III	N	SR14	3	P	1.00	A	52,296	51,648	Y	N	0		47
JUD 350		9/16/2019	2/1/20	22542	Judicial Clerk III	N	SR14	3	P	1.00	A	44,724	44,724	Y	N	0		48

Judiciary
Vacancy Report as of November 30, 2019

Table 11

Prog ID	Sub-Org	Date of Vacancy	Expected Fill Date	Position Number	Position Title	Exempt (Y/N)	SR Level	BU Code	Perm Temp (P/T)	FTE	MOF	Budgeted Amount	Actual Salary Last Paid	Authority to Hire (Y/N)	Occupied by 89 Day Hire (Y/N)	# of 89 Hire Appts	Describe if Filled by other Means	Priority # to Retain
JUD 601		3/1/2018	3/31/20	59332	IT Support Technician IV	N	SR19	3	P	1.00	A	46,476	69,144	Y	N	0		49
JUD 601		12/30/2017	2/28/20	25592	IT Specialist IV	N	SR22	13	P	1.00	A	52,956	76,692	Y	N	0		50
JUD 310		3/27/2019	3/25/20	17613	Social Worker IV	N	SR22	13	P	1.00	A	66,581	72,528	Y	N	0		51
JUD 310		9/3/2019	2/11/20	4749	Social Worker IV	N	SR22	13	P	1.00	A	52,623	57,324	Y	N	0		52
JUD 310		10/1/2019	3/30/20	21679	Social Worker IV	N	SR22	13	P	1.00	A	69,247	57,324	Y	N	0		53
JUD 310		10/7/2019	3/30/20	59723	Social Worker IV	N	SR22	13	P	1.00	A	52,623	57,324	Y	N	0		54
JUD 310		10/7/2019	3/25/20	18663	Social Worker IV	N	SR22	13	P	1.00	A	56,920	59,616	Y	N	0		55
JUD 310		10/19/2019	3/25/20	4771	Social Worker IV	N	SR22	13	P	1.00	A	48,614	52,956	Y	N	0		56
JUD 310		11/12/2019	4/28/20	58554	Social Worker IV	N	SR22	13	P	1.00	A	48,614	59,616	Y	N	0		57
JUD 310		11/30/2019	3/30/20	57622	Social Worker IV	N	SR22	13	P	1.00	A	71,990	78,420	Y	N	0		58
JUD 310		1/14/2019	2/28/20	58224	Land & Tax Appeal Ct Clerk	N	SR17	3	P	1.00	A	42,063	44,724	Y	N	0		59
JUD 310		2/27/2019	2/28/20	58924	Land & Tax Appeal Ct Clerk	N	SR17	3	P	1.00	A	47,311	50,304	Y	N	0		60
JUD 310		6/1/2019	2/28/20	23037	District Court Clerk II	N	SR17	3	P	1.00	A	62,254	66,192	Y	N	0		61
JUD 310		8/1/2019	2/28/20	14527	District Court Clerk II	N	SR17	3	P	1.00	A	57,536	61,176	Y	N	0		62
JUD 310		8/2/2019	2/28/20	25245	District Court Clerk II	N	SR17	3	P	1.00	A	38,903	44,724	Y	N	0		63
JUD 310		2/25/2019	2/28/20	57811	Accountant III	N	SR20	13	P	1.00	A	32,351	34,020	Y	N	0		64
JUD 310		4/13/2019	3/30/20	59480	Social Worker III	N	SR20	13	P	1.00	A	41,574	45,288	Y	N	0		65
JUD 310		10/1/2019	3/25/20	8923	Social Worker III	N	SR20	13	P	1.00	A	46,741	50,916	Y	N	0		66
JUD 310		8/1/2019	2/26/20	57034	Social Worker II	N	SR18	13	P	1.00	A	41,574	48,948	Y	N	0		67
JUD 310		10/28/2019	4/7/20	58821	Social Worker II	N	SR18	13	P	1.00	A	44,934	45,288	Y	N	0		68
JUD 310		8/25/2019	4/3/20	58670	Juvenile Detention Worker II	N	CO05	10	P	1.00	A	51,015	56,688	Y	N	0		69
JUD 310		8/30/2019	4/3/20	58755	Juvenile Detention Worker II	N	CO05	10	P	1.00	A	51,015	56,688	Y	N	0		70
JUD 310		9/27/2019	2/28/20	4784	Accountant III	N	SR20	13	P	1.00	A	52,390	55,092	Y	N	0		71
JUD 310		10/8/2019	1/31/20	59001	Accountant II	N	SR18	13	P	1.00	A	46,547	45,288	Y	N	0		72
JUD 310		11/30/2019	2/28/20	57540	Court Bailiff II	N	SR15	3	P	1.00	A	51,193	54,432	Y	N	0		73
JUD 310		4/4/2018	4/28/20	4793	Paralegal Assistant II	N	SR20	3	P	1.00	A	43,502	46,752	Y	N	0		74
JUD 310		11/15/2019	4/28/20	19197	Secretary II	N	SR14	3	P	1.00	A	35,086	38,220	Y	N	0		75
JUD 320		10/1/2018	3/30/20	57758	District Court Clerk II	N	SR17	3	P	1.00	A	37,656	39,228	Y	N	0		76
JUD 320		9/10/2019	2/3/20	58332	Judicial Clerk II	N	SR12	3	P	1.00	A	49,561	50,304	Y	N	0		77
JUD 330		11/1/2019	1/30/20	59207	Clerk IV	N	SR10	3	P	1.00	A	41,681	41,364	Y	N	0		78
JUD 330		11/9/2019	1/30/20	59241	Social Worker III	N	SR20	13	P	1.00	A	53,362	48,948	Y	N	0		79
JUD 601		8/28/2019	2/28/20	57124	Clerk III	N	SR08	3	P	1.00	A	31,031	30,240	Y	N	0		80
JUD 601		4/19/2019	3/31/20	500420	IT Support Technician III	N	SR17	3	P	1.00	A	43,008	43,008	Y	N	0		81
JUD 601		10/22/2019	2/28/20	59165	DUI Adjudicator	Y	SR26	13	P	1.00	A	75,432	81,588	Y	N	0		82
JUD 601		11/14/2019	2/28/20	59381	Clerk III	N	SR08	3	P	1.00	A	32,319	34,020	Y	N	0		83
JUD 310		7/10/2019	3/31/20	4735	Estate & Guardianship Spclt	N	SR19	3	P	1.00	A	43,711	46,476	Y	N	0		84
JUD 310		11/12/2019	1/31/20	57968	Groundskeeper I	N	BC02	1	P	1.00	A	39,529	42,396	Y	N	0		85
JUD 310		7/8/2019	1/31/20	15302	Judicial Clerk IV	N	SR16	3	P	1.00	A	40,449	43,008	Y	N	0		86
JUD 310		11/18/2019	3/1/20	58578	Judicial Clerk III	N	SR14	3	P	1.00	A	37,357	39,720	Y	N	0		87
JUD 310		8/1/2019	2/15/20	59347	Judicial Clerk III	N	SR14	3	P	1.00	A	45,471	48,348	Y	N	0		88
JUD 310		11/30/2019	2/28/20	57804	Judicial Clerk III	N	SR14	3	P	1.00	A	37,357	39,720	Y	N	0		89
JUD 310		9/9/2019	3/1/20	57800	Judicial Clerk II	N	SR12	3	P	1.00	A	33,237	35,340	Y	N	0		90
JUD 310		9/10/2019	3/1/20	57102	Judicial Clerk II	N	SR12	3	P	1.00	A	33,237	35,340	Y	N	0		91
JUD 310		11/30/2019	1/31/20	57808	Judicial Clerk II	N	SR12	3	P	1.00	A	35,946	38,220	Y	N	0		92
JUD 310		10/9/2019	2/15/20	57523	Judicial Clerk II	N	SR12	3	P	1.00	A	35,946	38,220	Y	N	0		93
JUD 310		8/5/2019	1/31/20	23007	Judicial Clerk I	N	SR10	3	P	1.00	A	35,946	32,664	Y	N	0		94
JUD 310		9/12/2019	2/15/20	27894	Judicial Clerk I	N	SR10	3	P	1.00	A	28,441	32,664	Y	N	0		95
JUD 310		10/22/2019	1/31/20	15369	Judicial Clerk I	N	SR10	3	P	1.00	A	31,996	34,020	Y	N	0		96
JUD 310		10/24/2019	1/31/20	17649	Judicial Clerk I	N	SR10	3	P	1.00	A	28,441	32,664	Y	N	0		97
JUD 310		11/25/2019	3/15/20	58695	Judicial Clerk I	N	SR10	3	P	1.00	A	28,441	32,664	Y	N	0		98
JUD 320		11/16/2018	3/11/20	58330	Judicial Clerk I	N	SR10	3	P	1.00	A	32,182	31,056	Y	N	0		99

Judiciary
Vacancy Report as of November 30, 2019

Table 11

Prog ID	Sub-Org	Date of Vacancy	Expected Fill Date	Position Number	Position Title	Exempt (Y/N)	SR Level	BU Code	Perm Temp (P/T)	FTE	MOF	Budgeted Amount	Actual Salary Last Paid	Authority to Hire (Y/N)	Occupied by 89 Day Hire (Y/N)	# of 89 Hire Appts	Describe if Filled by other Means	Priority # to Retain
JUD 320		5/2/2019	3/11/20	58331	Judicial Clerk II	N	SR12	3	P	1.00	A	34,818	35,340	Y	N	0		100
JUD 320		7/20/2019	3/11/20	57328	Judicial Clerk II	N	SR12	3	P	1.00	A	34,818	35,340	Y	N	0		101
JUD 350		11/1/2019	3/1/20	57335	Social Service Assistant IV	N	SR11	3	P	1.00	A	34,020	34,020	Y	N	0		102
JUD 330		6/7/2018		59288	District Judge (PD)	Y	JG09	0	T	0.20	A	*	751.90/day	Y	N	0		103
JUD 330		10/25/2019		59287	District Judge (PD)	Y	JG09	0	T	0.20	A	*	774.91/day	Y	N	0		104
JUD 330		7/21/2018		57646	District Judge (PD)	Y	JG09	0	T	0.20	A	*	766.95/day	Y	N	0		105
JUD 330		8/31/2018		500797	District Judge (PD)	Y	JG09	0	T	0.20	A	*	774.91/day	Y	N	0		106
JUD 330		11/4/2019		500798	District Judge (PD)	Y	JG09	0	T	0.20	A	*	774.91/day	Y	N	0		107
JUD 310		8/7/2019	2/28/20	57397	Clerk IV	N	SR10	3	P	1.00	A	30,720	32,664	Y	N	0		108
JUD 310		8/20/2019	2/15/20	57813	Judicial Clerk I	N	SR10	3	P	1.00	A	33,237	30,240	Y	N	0		109
JUD 310		12/29/2018	4/30/20	14894	Court Reporter II	N	SR25	3	P	1.00	A	59,827	62,832	Y	N	0		110
JUD 310		2/15/2019	4/30/20	12137	Court Reporter II	N	SR25	3	P	1.00	A	62,254	66,192	Y	N	0		111
JUD 310		10/5/2019	2/28/20	59390	Court Reporter II	N	SR25	3	P	1.00	A	64,703	68,796	Y	N	0		112
JUD 310		8/31/2019	3/1/20	59335	IT Support Technician III	N	SR17	3	P	1.00	A	55,939	58,824	Y	N	0		113
JUD 310		10/6/2018	1/31/20	4708	IT Support Technician III	N	SR17	3	P	1.00	A	55,324	65,376	Y	N	0		114
JUD 310		10/22/2019	1/31/20	6622	Judicial Clerk V	N	SR18	4	P	1.00	A	42,063	46,476	Y	N	0		115
JUD 310		3/7/2019	2/1/20	58939	Human Resources Clerk IV	N	SR11	63	P	1.00	A	32,351	34,020	Y	N	0		116
JUD 310		4/27/2019	2/1/20	57233	Human Resources Clerk IV	N	SR11	63	P	1.00	A	32,351	34,020	Y	N	0		117
JUD 310		9/20/2019	1/31/20	4729	Judicial Clerk II	N	SR12	3	P	1.00	A	35,946	35,340	Y	N	0		118
JUD 310		10/12/2019	1/31/20	15146	Judicial Clerk II	N	SR12	3	P	1.00	A	30,720	35,340	Y	N	0		119
JUD 310		10/25/2019	1/31/20	15145	Judicial Clerk II	N	SR12	3	P	1.00	A	45,471	48,348	Y	N	0		120
JUD 310		11/7/2019	2/28/20	58863	Judicial Clerk II	N	SR12	3	P	1.00	A	33,237	35,340	Y	N	0		121
JUD 310		8/24/2019	2/26/20	17610	Clerk IV	N	SR10	3	P	1.00	A	29,986	32,664	Y	N	0		122
JUD 310		12/7/2018	2/28/20	57227	Judicial Clerk I	N	SR10	3	P	1.00	A	30,720	32,256	Y	N	0		123
JUD 310		11/2/2019	4/27/20	57798	Clerk III	N	SR08	3	P	1.00	A	27,760	30,240	Y	N	0		124
JUD 310		12/10/2018	2/28/20	17676	Clerk III	N	SR08	3	P	1.00	A	28,441	28,728	Y	N	0		125
JUD 310		10/28/2019	2/28/20	4722	Clerk III	N	SR08	3	P	1.00	A	28,441	30,240	Y	N	0		126
JUD 310		7/8/2019	3/25/20	500647	Juvenile Counselor I	N	SR16	73	T	1.00	A	38,424	20.12/hr	Y	N	0		127
JUD 310		8/30/2018		57640	District Judge (PD)	Y	JG09	0	T	0.20	A	*	766.95/day	Y	N	0		128
JUD 310		8/10/2019	3/25/20	500577	Juvenile Counselor I	N	SR16	73	T	1.00	A	39,966	20.93/hr	Y	N	0		129
JUD 310		6/1/2019	3/5/20	500702	Juvenile Detention Worker I	N	CO03	70	T	1.00	A	43,502	22.78/hr	Y	N	0		130
JUD 310		6/29/2019	3/1/20	500081	Law Clerk	N	SR20	73	T	1.00	A	45,657	48,948	Y	N	0		131
JUD 310		8/23/2016		58029	District Judge (PD)	Y	JG09	0	T	0.20	A	*	737.14/day	Y	N	0		132
JUD 310		8/10/2019	2/15/20	500300	Ct Optns Spclt V	N	SR24	73	T	0.48	A	26,298	28.66/hr	Y	N	0		133
*Per Diem Judges used on intermittent basis, therefore no "budgeted amount" assigned to individual positions.																		
Special Fund																		
JUD 310		10/14/2019	6/30/20	26900	Asst Driver Educ Prgm Admr	N	SR22	13	P	1.00	B	49,037	62,004	Y	N	0		1
JUD 310		10/24/2019	1/27/20	26947	Clerk IV	N	SR10	3	P	1.00	B	30,247	32,664	Y	N	0		2
JUD 310		12/11/2018	6/30/20	58158	Clerk III	N	SR08	3	P	1.00	B	28,002	28,728	Y	N	0		3
JUD 310		11/23/2019	6/30/20	57016	Clerk III	N	SR08	3	P	1.00	B	28,002	30,240	Y	N	0		4

Judiciary

Table 12

Positions Established by Acts other than the State Budget as of November 30, 2019

<u>Prog ID</u>	<u>Sub-Org</u>	<u>Date Established*</u>	<u>Legal Authority</u>	<u>Position Number*</u>	<u>Position Title*</u>	<u>Exempt (Y/N)</u>	<u>SR Level*</u>	<u>BU Code</u>	<u>T/P</u>	<u>MOF</u>	<u>FTE</u>	<u>Annual Salary*</u>	<u>Filled (Y/N)</u>	<u>Occupied by 89 Day Hire (Y/N)</u>
JUD 101			Act 179/19		Criminal Justice Research Institute Director	Y	EM07	35	P	A	1.00	\$99,636-\$138,396	N	N
JUD 101			Act 179/19		Criminal Justice Research Institute Researcher	Y	SR24	13	P	A	1.00	\$59,616 - \$69,732	N	N
JUD 101			Act 179/19		Criminal Justice Research Institute Researcher	Y	SR24	13	P	A	1.00	\$59,616 - \$69,732	N	N
JUD 101			Act 179/19		Criminal Justice Research Secretary	Y	SR16	03	P	A	1.00	\$38,220 - \$46,476	N	N

*Act 179/19 appropriated six months funding for the four Criminal Justice Research Institute positions in FY 2020. Due to the partial year funding, the positions were not established as of November 30, 2019.

Judiciary
Overtime Expenditure Summary

Prog ID	Sub-Org	Program Title	MOF	FY18 (actual)			FY19 (actual)			FY20 (estimated)			FY21 (budgeted)		
				Base Salary \$\$\$\$	Overtime \$\$\$\$	Overtime Percent	Base Salary \$\$\$\$	Overtime \$\$\$\$	Overtime Percent	Base Salary \$\$\$\$	Overtime \$\$\$\$	Overtime Percent	Base Salary \$\$\$\$	Overtime \$\$\$\$	Overtime Percent
JUD 101		Courts of Appeal	A	\$ 6,369,210	\$ 7	0.0%	\$ 6,433,744	\$ 556	0.0%	\$ 6,754,604	\$ -	0.0%	\$ 6,821,612	\$ -	0.0%
JUD 310		First Circuit	A	\$ 59,183,174	\$ 1,245,406	2.1%	\$ 60,638,553	\$ 1,630,769	2.7%	\$ 65,302,087	\$ 1,140,606	1.7%	\$ 65,640,494	\$ 1,140,606	1.7%
			B	\$ 1,442,114	\$ 77	0.0%	\$ 1,494,345	\$ -	0.0%	\$ 1,699,753	\$ -	0.0%	\$ 1,699,753	\$ -	0.0%
JUD 320		Second Circuit	A	\$ 11,154,100	\$ 32,160	0.3%	\$ 11,761,342	\$ 18,861	0.2%	\$ 12,466,186	\$ 97,097	0.8%	\$ 12,789,202	\$ 97,097	0.8%
JUD 330		Third Circuit	A	\$ 12,524,903	\$ 27,222	0.2%	\$ 12,908,667	\$ 66,103	0.5%	\$ 14,674,554	\$ 32,246	0.2%	\$ 14,744,400	\$ 32,246	0.2%
JUD 350		Fifth Circuit	A	\$ 5,263,469	\$ 10,206	0.2%	\$ 5,347,454	\$ 3,585	0.1%	\$ 6,398,136	\$ 11,450	0.2%	\$ 6,429,558	\$ 11,450	0.2%
JUD 501		Jud Selection Commission	A	\$ 68,768	\$ -	0.0%	\$ 56,522	\$ -	0.0%	\$ 71,435	\$ -	0.0%	\$ 71,435	\$ -	0.0%
JUD 601		Administration	A	\$ 14,716,124	\$ 112,029	0.8%	\$ 14,324,757	\$ 147,233	1.0%	\$ 15,864,947	\$ 118,311	0.7%	\$ 15,866,000	\$ 118,311	0.7%
			B	\$ 709,399	\$ 2,131	0.3%	\$ 709,968	\$ 467	0.1%	\$ 724,584	\$ 3,130	0.4%	\$ 724,584	\$ 3,130	0.4%

Judiciary
Active Contracts as of December 1, 2019

Prog ID	MOF	Amount	Frequency (M/A/O)	Max Value	Outstanding Balance	Date Executed	From	To	Entity	Contract Description	Explanation of How Contract is Monitored*	POS Y/N	Category E/L/P/C/G/S/*
JUD 310	A	359.27	M	21,556.20	12,933.72	12/1/2017	12/1/2017	11/30/2022	XEROX CORPORATION	CC1-ACSB 5 YR LSE XEROX XC70 COPIER FOR AJCSRJ		N	E
JUD 310	A	445.86	M	26,751.60	16,050.96	12/1/2017	12/1/2017	11/30/2022	XEROX CORPORATION	REPLACEMENT OF COPIER AT WAIANAE-XC70		N	E
JUD 310	A	VARIOUS	O	14,000.00	0.00	10/1/2019	10/1/2019	9/30/2020	FAMILY PROGRAM OF HAWAII	FC1 ITAO WEB SITE		Y	S
JUD 310	A	VARIOUS	O	5,500.00	2,750.00	10/1/2018	10/1/2019	9/30/2020	FAMILY HUI	PARENT EDUCATION CIP		Y	S
JUD 310	B	275.68	M	16,540.80	11,027.20	4/1/2018	4/1/2018	3/31/2023	TOSHIBA AMERICA BUS SOLUTIONS, INC.	60 MO LEASE: 2 TOSHIBA E-STUDIO7506 COPIERS		N	E
JUD 310	B	202.93	M	12,175.80	8,117.20	4/1/2018	4/1/2018	3/31/2023	TOSHIBA AMERICA BUS SOLUTIONS, INC.	60 MO LEASE: 2 TOSHIBA E-STUDIO 5506 COPIERS		N	E
JUD 310	A	3,915.00	O-AS NEED	82,215.00	27,405.00	7/1/2018	12/1/2019	11/30/2020	EMSS INC	CC1 FABR/PRINT/MAIL OUT JUROR QUESTIONNR		N	S
JUD 310	A	9,232.00	O-AS NEED	9,232.00	9,232.00	7/1/2018	7/1/2019	6/30/2020	SIMS HAWAII ENTERPRISES	CC1 PROCSSNG JUROR QUESTIONNAIRES/SUMMONS		N	S
JUD 310	B	150.00	O	1,950.00	1,800.00	7/1/2018	7/1/2019	6/30/2020	BIVENS, ALEXANDER J.	FC5 KIDS FIRST FACILITATOR		N	S
JUD 310	B	110,000.00	A	330,000.00	174,166.67	7/1/2018	7/1/2018	6/30/2021	PREVENTION RESEARCH INC.	PRIME FOR LIFE WORKBOOKS		N	G
JUD 310	A	896.53	A	10,758.37	6,275.72	7/1/2018	7/1/2019	6/30/2020	PHOENIX PACIFIC, INC.	ANNUAL FIRE ALARM MAINTENANCE		N	S
JUD 310	B	196.12	M	11,767.20	9,021.52	10/1/2018	10/1/2018	9/30/2023	XEROX CORPORATION	DC1 LEASE OF XEROX COPIER -DRIVER ED MAUI DIV		N	E
JUD 310	A	12,985.00	A	12,985.00	12,985.00	12/20/2018	12/20/2018	12/15/2019	AVR DISTRIBUTORS	FC1 PROVIDE AND PRINT FILE FOLDER COVERS		N	S
JUD 310	A	141.57	M	8,493.97	6,795.18	12/1/2018	12/1/2018	11/30/2023	XEROX CORPORATION	DC1 LEASE XEROX COPIER -DC1 -HOOKELE ON 3RD FL		N	E
JUD 310	A	153.00	M	9,180.00	7,497.00	12/1/2018	12/1/2018	11/30/2023	XEROX CORPORATION	CC1-FM 5 YR LEASE XEROX C8035H-FAC MGT		N	E
JUD 310	A	VARIOUS	M	240,000.00	234,414.35	7/1/2019	7/1/2019	6/30/2021	TECHNICAL RESOURCE MANAGEMENT, LLC	CC1-ACSB OFFENDER ELECTRONIC MONITORING SVCS		N	S
JUD 310	A	225.00	M	13,500.00	11,475.00	1/1/2019	1/1/2019	12/31/2023	XEROX CORPORATION	CC1-5 YR LEASE XEROX ALTALINK - LAND & TAX CRT		N	E
JUD 310	A	5,400.00	O	5,400.00	5,400.00	10/1/2018	10/1/2019	9/30/2020	1A SMART START, LLC (DWI)	CONTRACT FOR BREATHALYZER		N	S
JUD 310	A	6,750.00	O	8,100.00	6,750.00	10/1/2018	10/1/2019	9/30/2020	ALCOHOL MONITORING SYST (DWI)	CONTRACT FOR SCRAM CAM		N	S
JUD 310	A	362.71	M	21,762.60	18,860.92	4/1/2019	4/1/2019	3/31/2024	XEROX CORPORATION	CC1-ACSB 5 YR LSE XEROX XC70 COPIER FOR ICSS		N	E
JUD 310	A	251.23	M	15,073.80	13,315.19	4/30/2019	4/30/2019	5/1/2024	XEROX CORPORATION	FC1 LEASE - 1 COPIER FOR CASA		N	E
JUD 310	A	243.22	M	14,593.20	12,890.66	4/30/2019	4/30/2019	5/1/2024	XEROX CORPORATION	FC1 LEASE - 1 COPIER FOR JDC		N	E
JUD 310	B	172.58	M	10,354.80	8,974.16	4/1/2019	4/1/2019	3/30/2024	XEROX CORPORATION	DC1 LEASE OF XEROX COPIER - DRIVER ED HILO OFF		N	E
JUD 310	A	17,238.00	O	17,238.00	17,238.00	4/16/2019	4/16/2019	4/15/2020	SBL SOLUTIONS LLC	DC CRIMINAL DISPOSITION FORMS		N	G
JUD 310	A	479.00/507.00	M	6,000.00	2,535.00	4/1/2017	4/1/2019	3/31/2020	CR DISPATCH SERVICES	CC1 ARMORED CAR SERVICES		N	S
JUD 310	A	VARIOUS	M	21,590.42	3,598.40	4/1/2019	4/1/2019	3/31/2020	SECURITY ARMORED CAR & COURIER	DC1 ARMORED CAR SERVICE FOR DC1		N	S
JUD 310	A	766.95/774.91	O - DAY	11,597.93	0.00	3/24/2019	3/24/2019	3/23/2020	AKAMU, KELLEN KENJI	CC1 GRAND JURY COUNSEL		N	C
JUD 310	A	766.95/774.91	O - DAY	13,125.71	0.00	3/24/2019	3/24/2019	3/23/2020	SCANLAN, ALEXANDER P.	CC1 GRAND JURY COUNSEL		N	C
JUD 310	A	766.95/774.91	O - DAY	3,834.75	0.00	3/24/2019	3/24/2019	3/23/2020	KIM, JIN TAE	CC1 GRAND JURY COUNSEL		N	C
JUD 310	A	766.95/774.91	O - DAY	12,350.80	0.00	3/24/2019	3/24/2019	3/23/2020	MATTICE, DALE K.	CC1 GRAND JURY COUNSEL		N	C
JUD 310	A	766.95/774.91	O - DAY	3,099.64	0.00	9/23/2019	9/23/2019	9/22/2020	GUTIERREZ, CATHERINE P.	CC1 GRAND JURY COUNSEL		N	C
JUD 310	A	766.95/774.91	O - DAY	13,892.66	0.00	3/24/2019	3/24/2019	3/23/2020	JAMESON, LINDA C.R.	CC1 GRAND JURY COUNSEL		N	C
JUD 310	A	97,995.00	O	97,995.00	97,995.00	10/1/2019	10/1/2019	3/18/2020	SOCIETY CONTRACTING, LLC	DC1 CARP REPL KAUIKEAOULI HALE JUDGES CHAMBR		N	G
JUD 310	A	8,333.33	M	100,000.00	0.00	10/1/2018	10/1/2018	9/30/2019	PARENTS AND CHILDREN TOGETHER	FC1 SUPERVISE CHILD VISITATION/SAFE EXCHANGE		Y	S
JUD 310	N	VARIOUS	O	202,890.00	3,200.00	5/1/2019	5/1/2019	9/30/2021	JUSTICE SYST ASSMT & TRAINING (JSAT)	CC1-ACSB ICIS TRAINING, COACHING, RESCH & CONSLT		N	S
JUD 310	A	VARIOUS	O	56,000.00	54,051.50	7/1/2019	7/1/2019	6/30/2021	DIAGNOSTIC LABORATORY SERVICES, INC.	FC1 STATEWIDE DRUG COLL, SCREENING & CONFIRM		N	S
JUD 310	B	537.00	O	5,000.00	3,803.00	7/1/2019	7/1/2019	6/30/2020	CHING, JUNE W.J., PH.D.	FC1 KIDS FIRST PRESENTER		N	S
JUD 310	B	1,875.00	O	7,500.00	5,625.00	7/1/2019	7/1/2019	6/30/2020	ARMSTRONG, JOLENE	FC3 KIDS FIRST COORDINATOR		N	S
JUD 310	A	4,500.00	A/O	4,500.00	0.00	7/1/2019	7/1/2019	6/30/2020	FORELLE, NICOLE LLC	FC1 LEGAL SERVICE TRAINING		N	S
JUD 310	B	100.00	O	2,400.00	1,900.00	7/1/2019	7/1/2019	6/30/2020	NEWBOLD, REBEKAH	FC1 KIDS FIRST PRESENTER		N	S
JUD 310	B	537.00	O	5,000.00	3,680.00	7/1/2019	7/1/2019	6/30/2020	KOPF, DONALD PH.D.	FC1 KIDS FIRST PRESENTER		N	S
JUD 310	A	537.00	O	5,000.00	4,010.00	7/1/2019	7/1/2019	6/30/2020	ROGERS, BARBARA HIGA	FC1 KIDS FIRST PRESENTER		N	S
JUD 310	A	537.00	O	5,000.00	3,020.00	7/1/2019	7/1/2019	6/30/2020	SALVDOR, DARRYL	FC1 KIDS FIRST PRESENTER		N	S
JUD 310	N	4,500.00	A	4,500.00	0.00	7/1/2019	7/1/2019	6/30/2020	BOWERS, BEVANNE	FC2 SPECIAL COUNSEL SERVICES FOR CASA PROGRAM		N	S
JUD 310	B	3,750.00	Q	15,000.00	11,250.00	7/1/2019	7/1/2019	6/30/2020	SWENSON, GIULIETTA	FC2 KIDS FIRST COORDINATOR		N	S
JUD 310	A	VARIOUS	O	110,400.00	107,540.00	7/1/2019	7/1/2019	6/30/2021	HALE KIPA - INDEP LIVING PROGRAMS	FC1 INDEPENDENT LIVING PROGRAM SVCS		Y	S
JUD 310	A	VARIOUS	O	105,850.00	104,900.00	7/1/2019	7/1/2019	6/30/2021	HALE KIPA - INDEP LIVING PROGRAMS	FC1 INDEPENDENT LIVING PROGRAM SVCS		Y	S
JUD 310	A	VARIOUS	M	150,000.00	139,012.50	7/1/2019	7/1/2019	6/30/2021	CATHOLIC CHARITIES - CSATP	FC1 JUVENILE SEX OFFENDER TREATMENT		Y	S
JUD 310	A	100.00	O	2,400.00	1,800.00	7/1/2019	7/1/2019	6/30/2020	JILL SAKAMOTO	FC1 KIDS FIRST FACILITATOR		N	S
JUD 310	B	100.00	O	2,400.00	1,900.00	7/1/2019	7/1/2019	6/3/2020	GILMAN, REBECCA	FC1 KIDS FIRST FACILITATOR		N	S
JUD 310	B	100.00	O	2,400.00	2,000.00	7/1/2019	7/1/2019	6/30/2020	GOTO-HIROKAWA, DEBORAH	FC1 KIDS FIRST FACILITATOR		N	S
JUD 310	B	537.00	O	5,000.00	4,463.00	7/1/2019	7/1/2019	6/30/2020	NEEDEL, TERRI	FC1 KIDS FIRST PRESENTER		N	S
JUD 310	A	191.00	M	11,460.00	10,696.00	7/1/2019	7/1/2019	6/30/2024	XEROX CORPORATION	CC1 5 YR LEASE XEROX ALTALINK COPIER - FISCAL		N	E
JUD 310	A	34,225.00	M	821,400.00	684,500.00	7/1/2019	7/1/2019	6/30/2021	LEGAL AID SOCIETY OF HAWAII	FC1 GUARDIAN AD LITEM FC1		N	S
JUD 310	A	13,375.00	A	71,410.00	58,035.00	7/1/2019	7/1/2019	6/30/2024	KONE, INC.	CC1-FM ELEVATOR MAINTENANCE AT KANEOHE DC		N	S
JUD 310	A	1,000.00	M	24,000.00	19,000.00	7/1/2019	7/1/2019	6/30/2020	MEDIATION CENTERS OF HAWAII	FC1 ADR MEDIATION SERVICES		Y	S
JUD 310	B	537.00	O	5,000.00	4,340.00	7/1/2019	7/1/2019	6/30/2020	WONG, KAY S., PH.D.	FC1 KIDS FIRST PRESENTER		N	S
JUD 310	B	100.00	O	2,400.00	1,900.00	7/1/2019	7/1/2019	6/30/2020	FEURSON-QUICK, SHARON	FC1 KIDS FIRST FACILITATOR		N	S
JUD 310	B	100.00	O	2,400.00	1,800.00	7/1/2019	7/1/2019	6/30/2020	MIZUKAMI, GAYLE	FC1 KIDS FIRST FACILITATOR		N	S

Judiciary
Active Contracts as of December 1, 2019

Prog ID	MOF	Amount	Frequency (M/A/O)	Max Value	Outstanding Balance	Date Executed	From	To	Entity	Contract Description	Explanation of How Contract is Monitored*	POS Y/N	Category E/L/P/C/G/S/*
JUD 310	A	100.00	O	2,400.00	1,900.00	7/1/2019	7/1/2019	6/30/2020	ROWE, CAROLANN	FC1 KIDS FIRST FACILITATOR		N	S
JUD 310	A	VARIOUS	O	88,800.00	82,800.00	7/1/2019	7/1/2019	6/30/2021	ROGERS, BARBARA HIGA	FC1 JUVENILE MENTAL HEALTH ASSESSMENTS		Y	S
JUD 310	A	VARIOUS	O	40,000.00	40,000.00	7/1/2019	7/1/2019	6/30/2021	WAIANAE COAST COMPR HEALTH CENTER	FC1 JUVENILE ANGER MANAGEMENT		Y	S
JUD 310	B	2,812.50	Q	11,250.00	8,437.50	7/1/2019	7/1/2019	6/30/2020	SAWYER, KAPUAHELELANI	FC3 KIDS FIRST COORDINATOR		N	S
JUD 310	A	VARIOUS	O	940,000.00	940,000.00	7/1/2019	7/1/2019	6/30/2021	SALVATION ARMY, THE	CC1-ACSB ADULT SUBSTANCE ABUSE TREATMENT SVCS		Y	S
JUD 310	A	VARIOUS	O	80,000.00	80,000.00	7/1/2019	7/1/2019	6/30/2021	WOMEN IN NEED	CC1-ACSB ADULT SUBSTANCE ABUSE TREATMENT SVCS		Y	S
JUD 310	A	VARIOUS	O	302,400.00	302,400.00	7/1/2019	7/1/2019	6/30/2021	HO'OMAU KE ALOHA	CC1-ACSB ADULT SUBSTANCE ABUSE TREATMENT SVCS		Y	S
JUD 310	A	VARIOUS	O	130,000.00	130,000.00	7/1/2019	7/1/2019	6/30/2021	KOKUA SUPPORT SERVICES	CC1-ACSB ADULT SUBSTANCE ABUSE TREATMENT SVCS		Y	S
JUD 310	A	VARIOUS	O	300,000.00	300,000.00	7/1/2019	7/1/2019	6/30/2021	CARE HAWAII, INC.	CC1-ACSB ADULT SUBSTANCE ABUSE TREATMENT SVCS		Y	S
JUD 310	A	VARIOUS	O	700,000.00	700,000.00	7/1/2019	7/1/2019	6/30/2021	HINA MAUKA	CC1-ACSB ADULT SUBSTANCE ABUSE TREATMENT SVCS		Y	S
JUD 310	A	VARIOUS	O	200,000.00	200,000.00	7/1/2019	7/1/2019	6/30/2021	ACTION WITH ALOHA, LLC	CC1-ACSB SUBSTANCE ABUSE TREATMENT SERVICES		Y	S
JUD 310	A	VARIOUS	O	464,000.00	423,634.25	7/1/2019	7/1/2019	6/30/2021	COALITION FOR A DRUG FREE	FC1 FAMILY INTERVENTION SERVICES		Y	S
JUD 310	A	VARIOUS	O	600,000.00	600,000.00	7/1/2019	7/1/2019	6/30/2021	KLINE-WELSH BEHAVRIAL HEALTH FOUND	CC1-ACSB ADULT SUBSTANCE ABUSE TREATMENT SVCS		Y	S
JUD 310	A	VARIOUS	M	31,650.00	31,650.00	7/1/2019	7/1/2019	6/30/2020	H.T.M. CONTRACTORS	CC1-FM GROUNDSKEEPING SERVICES - VARIOUS CTS		N	S
JUD 310	A	795.81	O - QTR	3,183.24	2,386.43	7/1/2019	7/1/2019	6/30/2020	COMMERCIAL SHELVING INC.	FC1 MAINT. - ROLL DOORS AT KAPOLEI COURTHOUSE		N	S
JUD 310	A	262.51	M	15,750.60	14,438.05	7/1/2019	7/1/2019	6/30/2024	XEROX CORPORATION	FC1 LEASE - 1 COPIER - JUVENILE DETENTION FACILITY		N	E
JUD 310	A	VARIOUS	O	180,000.00	142,457.03	7/1/2019	7/1/2019	6/30/2021	GIOVANNONI, JOSEPH INC.	CC1-ACSB ADULT SEX OFFNDR ASSMT AND TREATMT		Y	S
JUD 310	A	VARIOUS	O	200,000.00	200,000.00	7/1/2019	7/1/2019	6/30/2021	YMCA OF HONOLULU	COUNSELNG & TUTORING SERVICES		Y	S
JUD 310	B	100.00	O	2,400.00	1,700.00	7/1/2019	7/1/2019	6/30/2020	LOWE, KIANA (DIANE)	FC1 KIDS FIRST FACILITATOR		N	S
JUD 310	B	537.00	O	5,000.00	3,350.00	7/1/2019	7/1/2019	6/30/2020	GRAY, JILL	FC1 KIDS FIRST PRESENTER		N	S
JUD 310	B	537.00	O	5,000.00	4,010.00	7/1/2019	7/1/2019	6/30/2020	HASHIMOTO, SCOTT	FC1 KIDS FIRST PRESENTER		N	S
JUD 310	A	3,971.00	A	3,971.00	0.00	7/1/2011	7/1/2019	6/30/2020	L-3 COMMUNICATIONS SECURITY	CC1 -SECURITY WALK-THRU MAINTENANCE		N	S
JUD 310	A	5,956.50	A	5,956.50	0.00	7/1/2019	7/1/2019	6/30/2020	L-3 COMMUNICATIONS SECURITY	FC1 SECURITY XRAY MAINT FOR CT FACILITIES		N	S
JUD 310	A	9,500.00	A	9,500.00	0.00	7/1/2010	7/1/2019	6/30/2020	L-3 SECURITY & DETECTION SYSTEMS, INC.	DC1 SEC XRAY MAINT FOR CT FAC - HNL & RURAL CTS		N	S
JUD 310	A	102,675.00	M	2,464,200.00	2,053,500.00	7/1/2019	7/1/2019	6/30/2021	HONG, MALCOLM E. ESQ.	FC1 GUARDIAN AD LITEM		N	S
JUD 310	A	VARIOUS	O	270,000.00	270,000.00	7/1/2019	7/1/2019	6/30/2021	YMCA OF HONOLULU	FC1 SUBSTANCE ABUSE TREATMENT		Y	S
JUD 310	A	VARIOUS	O	305,330.00	294,733.75	7/1/2019	7/1/2019	6/30/2021	HINA MAUKA - TEEN CARE	FC1 JUVENILE SUBSTANCE ABUSE TREATMENT		Y	S
JUD 310	A	VARIOUS	O	285,000.00	285,000.00	7/1/2019	7/1/2019	6/30/2021	YMCA OF HONOLULU	FC1 SUBSTANCE ABUSE TREATMENT		Y	S
JUD 310	A	VARIOUS	M	53,600.00	48,740.00	7/1/2019	7/1/2019	6/30/2021	COMMUNITY ASSISTANCE CENTER	FC1 ANGER MANAGEMENT PROGRAM		Y	S
JUD 310	A	VARIOUS	O	200,000.00	200,000.00	7/1/2019	7/1/2019	6/30/2021	WAIANAE DISTR COMPR HEALTH & HOSP	CC1-ACSB ADULT SUBST ABUSE TREATMENT SVCS		Y	S
JUD 310	A	8,157.33	M	195,800.00	155,010.00	7/1/2019	7/1/2019	6/30/2021	UCERA	FC1 JUVENILE PHYSICIAN SERVICES		Y	S
JUD 310	A	VARIOUS	O	60,000.00	60,000.00	7/1/2019	7/1/2019	6/30/2021	WAIANAE DISTR COMPR HEALTH & HOSP	CC1-ACSB ADULT SEX OFFENDER ASSMT & TREATMT		Y	S
JUD 310	A	52,164.00	M	1,251,950.00	1,043,294.00	7/1/2019	7/1/2019	6/30/2021	PARENTS AND CHILDREN TOGETHER	FC1 DOMESTIC VIOLENCE INTERVENTION SERVICES		Y	S
JUD 310	B	15,083.00	M	362,000.00	301,668.00	7/1/2019	7/1/2019	6/30/2021	PARENTS AND CHILDREN TOGETHER	FC1 DOMESTIC VIOLENCE INTERVENTION SERVICES		Y	S
JUD 310	A	25,339.00	M	608,136.00	506,780.00	7/1/2019	7/1/2019	6/30/2021	PARENTS AND CHILDREN TOGETHER	FC1 SUPERVISED CHILD VISITATION/EXCHANGE SVCS		Y	S
JUD 310	B	3,875.00	M	93,000.00	77,500.00	7/1/2019	7/1/2019	6/30/2021	PARENTS AND CHILDREN TOGETHER	FC1 SUPERVISED CHILD VISITATION/EXCHANGE SVCS		Y	S
JUD 310	B	100.00	O	2,400.00	1,900.00	7/1/2019	7/1/2019	6/30/2020	VALERIO, CARMENCITA	FC1 KIDS FIRST FACILITATOR		N	S
JUD 310	A	145,440.93	A	436,322.79	290,881.86	7/1/2019	7/1/2019	6/30/2022	JEFFERSON AUDIO VIDEO SYSTEMS	FC1 SERVICE/MAINT. FOR COURT RECORDING SYSTEM		N	S
JUD 310	B	160.00	O - AS NEED	3,200.00	3,040.00	7/1/2019	7/1/2019	6/30/2020	JUSTICE SYST ASSMT & TRAINING (JSAT)	CC1-ACSB TRAINING CRITIQUES		N	S
JUD 310	A	2,366.93	M	28,403.13	28,403.16	7/1/2019	7/1/2019	6/30/2020	JOHNSON CONTROL, INC.	FC1 MAINT. FOR AUTOMATED HVAC SYSTEM		N	S
JUD 310	A	8,325.00	M	199,800.00	158,175.00	7/1/2019	7/1/2019	6/30/2021	NAGAMINE, DEAN T.	FC1 GUARDIAN AD LITEM SERVICES		N	S
JUD 310	A	40,322.00	M	967,740.00	789,784.00	7/1/2019	7/1/2019	6/30/2021	CHILD & FAMILY SERVICES	FC1 DOMESTIC VIOLENCE SERVICES		Y	S
JUD 310	B	833.00	M	20,000.00	16,668.00	7/1/2019	7/1/2019	6/30/2021	CHILD & FAMILY SERVICES	FC1 DOMESTIC VIOLENCE SERVICES		Y	S
JUD 310	A	107,877.00	M	2,589,068.00	2,157,560.00	7/1/2019	7/1/2019	6/30/2021	DOMESTIC VIOLENCE ACTION CENTER	FC1 DOMESTIC VIOLENCE INTERVENTION		Y	S
JUD 310	B	6,250.00	M	150,000.00	125,000.00	7/1/2019	7/1/2019	6/30/2021	DOMESTIC VIOLENCE ACTION CENTER	FC1 DOMESTIC VIOLENCE INTERVENTION		Y	S
JUD 310	A	1,666.00	M	20,000.00	15,002.00	7/1/2019	7/1/2019	6/1/2020	LEVI, MATT INVESTIGATIONS	FC1 JUVENILE DRUG COURT PROGRAM		Y	S
JUD 310	A	VARIOUS	O	100,000.00	100,000.00	7/1/2019	7/1/2019	6/30/2021	MARIMED FOUNDATION	FC1 IN COMMUNITY COUNSELING		Y	S
JUD 310	A	VARIOUS	O	5,000.00	5,000.00	7/1/2019	7/1/2019	6/30/2020	HALE MAILE KANE	FC1 EMERGENCY HOUSING		N	S
JUD 310	A	VARIOUS	O	5,000.00	4,045.01	7/1/2019	7/1/2019	6/30/2020	HO'OMAU KE OLA	FC1 EMERGENCY HOUSING		N	S
JUD 310	A	VARIOUS	O	10,000.00	8,446.00	7/1/2019	7/1/2019	6/30/2020	SALVATION ARMY	FC1 EMERGENCY HOUSING - KE OLA PONO		Y	S
JUD 310	A	VARIOUS	O	5,000.00	5,000.00	7/1/2019	7/1/2019	6/30/2020	WOMEN IN NEED	EMERGENCY HOUSING		N	S
JUD 310	A	VARIOUS	O	7,196.34	7,196.34	7/1/2019	7/1/2019	6/30/2020	HAWTHORNE PACIFIC INC.	FC1 MAINT. FOR EMERGENCY GENERATOR at KAPOLEI		N	S
JUD 310	B	100.00	O	2,400.00	1,800.00	7/1/2019	7/1/2019	6/30/2020	BAKER, FREIDA W.J.	FC1 KIDS FIRST FACILITATOR		N	S
JUD 310	A	VARIOUS	M	320,000.00	311,300.00	7/1/2019	7/1/2019	6/30/2021	PALAMA SETTLEMENT	FC1 IN-COMMUNITY SERVICES		Y	S
JUD 310	A	4,660.00	M + PER BOX	55,900.00	4,660.00	7/1/2011	7/1/2019	12/31/2019	ACE RECORDS MGT AND STORAGE	CC1 RECORDS STORAGE & RETRIEVAL SERVICES FOR		N	S
JUD 310	A	164,100.30	O	164,100.30	164,100.30	8/26/2019	8/26/2019	12/11/2019	SBL SOLUTIONS LLC	IFB STATEWIDE PURCHASE OF TRAFFIC CITATIONS		N	G
JUD 310	A	400.00	O - AS NEED	9,600.00	8,000.00	7/1/2019	7/1/2019	6/30/2020	WOMEN IN NEED	CC1-ACSB EMERGENCY HOUSING		N	S
JUD 310	A	500.00	O - AS NEED	24,500.00	21,410.00	7/1/2019	7/1/2019	6/30/2020	MAKANA O KE AKUA	CC1-ACSB EMERGENCY HOUSING		N	S
JUD 310	A	VARIOUS	M	347,832.00	333,344.00	7/1/2019	7/1/2019	6/30/2021	CARE HAWAII, INC.	FC1 JUVENILE SUBSTANCE ABUSE		Y	S

Judiciary
Active Contracts as of December 1, 2019

Table 14

Prog ID	MOF	Amount	Frequency (M/A/O)	Max Value	Outstanding Balance	Date Executed	From	To	Entity	Contract Description	Explanation of How Contract is Monitored*	POS Y/N	Category E/L/P/C/G/S/*
JUD 310	A	8,000.00	M	184,000.00	152,000.00	7/1/2019	7/1/2019	6/30/2021	SUSZNAH WESLEY COMMUNITY CENTER	FC1 INDIVIDUAL AND FAMILY THERAPY		Y	S
JUD 310	A	VARIOUS	O	62,400.00	62,400.00	7/1/2019	7/1/2019	12/31/2019	HAWAII CORRECTIONAL INDUSTRIES	CC1-ACSB STATEWIDE DRUG TESTING SUPPLIES		N	G
JUD 310	A	36,803.09	O	36,803.09	0.00	7/1/2019	7/1/2019	6/30/2020	SECURITY RESOURCES PACIFIC INC	DC SECURITY CAMERA & ACCESS SYSTEM MAINT		N	E
JUD 310	B	100.00	O	2,400.00	1,800.00	7/1/2019	7/1/2019	6/30/2020	GANOOT, MINDY	FC1 KIDS FIRST FACILITATOR		N	S
JUD 310	A	330.00	O	5,000.00	4,340.00	7/1/2019	7/1/2019	6/30/2020	PEDRO, DON. D.	FC1 KIDS FIRST PRESENTER		N	S
JUD 310	A	868.00	M	52,080.00	51,212.00	10/1/2019	10/1/2019	9/30/2024	XEROX CORPORATION	CC1 - 5 YR LEASE XEROX D125CP - LEG DOCS		N	E
JUD 310	B	100.00	O	2,400.00	2,400.00	7/1/2019	7/1/2019	6/30/2020	PARKHURST, JOYCE	FC1 KIDS FIRST FACILITATOR		N	S
JUD 310	A	179.38	M	10,762.80	10,404.04	10/1/2019	10/1/2019	9/30/2024	XEROX CORPORATION	DC1 LEASE XEROX COPIER FOR DC1 -HOOKELE 3RD FL		N	E
JUD 310	A	30,750.00	O	30,750.00	30,750.00	9/1/2019	9/1/2019	8/30/2020	UNIVERSITY OF CINCINNATI	CC1-ACSB TRAINING ON CPC ASSESSMENT TOOL		N	S
JUD 310	B	VARIOUS	O	14,000.00	13,000.00	10/1/2019	10/1/2019	9/30/2020	FAMILY MEDIATIN HAWAII	FC1 FAMILY MEDIATION SERVICES		Y	S
JUD 310	A	8,595.00	A	8,595.00	8,595.00	10/11/2019	10/11/2019	12/31/2019	AVR DISTRIBUTORS	CC1 PROVIDE AND PRINT FILE FOLDER COVERS		N	S
JUD 310	A	37,500.00	Q	150,000.00	150,000.00	7/1/2019	7/1/2019	6/30/2020	HAWAII FAMILY LAW CLINIC	TRAIN BY ATHLETIC COACHES		N	S
JUD 310	N	VARIOUS	O	49,700.00	49,700.00	9/1/2019	9/1/2019	7/31/2020	CYZAP, INC.	CC1-ACSB ICIS MGT INFO SYSTEM EXPANSION		N	S
JUD 310	A	2,513.09	A	2,513.09	0.00	12/1/2016	12/1/2019	11/30/2020	ADVANCED MICRO-IMAGE SYSTEMS HI INC	CC1 MICROFILM SCANNERS MAINTENANCE		N	S
JUD 310	A	12.21	M	146.52	146.52	7/11/2019	7/11/2019	7/10/2020	XEROX CORPORATION	12 MONTHS MAINT FEE WC3345DNI DC1 JSB		N	E
JUD 310	A	156.00	M	9,360.00	9,360.00	11/1/2019	11/1/2019	10/31/2024	XEROX CORPORATION	CC1 - 5 YR LEASE XEROX ALTALINK COPIER - CAAP		N	E
JUD 310	N	32,500.00	O	65,000.00	32,500.00	10/1/2019	10/1/2019	9/30/2020	NATL COUNC OF JUV AND FAM CT JUDGES	FC1 ASSESSMENT FOR CIP PROGRAM		N	S
JUD 310	N	VARIOUS	O	44,300.00	44,300.00	10/1/2019	10/1/2019	9/30/2021	CYZAP, INC.	CC1-ACSB HI INNOVATIONS SUPERVISION INITIATIVE		N	S
JUD 310	A	69,399.45	O	69,399.45	69,399.45	7/1/2019	7/1/2019	6/30/2020	SECURITY RESOURCES PACIFIC INC	DC1 CHANGE CELL BLOCK LOCKING SYSTEM		N	E
JUD 310	A	VARIOUS	M	296,000.00	65,777.78	1/1/1981	8/1/2017	7/31/2020	BANK OF HAWAII	DC1 BANK CARD PROCESSING SERVICE FEE FOR DC1		N	S
JUD 310	A	123.65	M	1,483.80	865.55	8/1/2014	7/1/2019	6/30/2020	ALERT ALARM OF HAWAII	DC1 MONITORING - BURGLAR/INTRSN - EWA CT		N	S
JUD 310	A	83.46	M	1,001.52	584.22	9/16/1997	7/1/2019	6/30/2020	ALERT ALARM OF HAWAII	DC1 MONITORING - BURGLAR/INTRSN - WAHIAWA CT		N	S
JUD 320	A	64.14	O/M	3,848.40	3,848.40	8/21/2019	11/15/2019	11/14/2024	XEROX CORPORATION	LEASE OF A XEROX B405DN COPIER FOR 2JC,		N	E
JUD 320	A	1,647.10	M	60,489.48	24,521.42	1/1/2019	1/1/2019	12/31/2021	THOMAS REUTER WEST	WESTLAW SUBSCRIPTION		N	S
JUD 320	A	64.14	O/M	3,848.40	3,017.94	10/12/2018	12/1/2018	11/30/2023	XEROX CORPORATION	LEASE OF A XEROX B405DN COPIER FOR 2JC,		N	E
JUD 320	A	64.14	O/M	3,848.40	3,121.14	10/12/2018	12/1/2018	11/30/2023	XEROX CORPORATION	LEASE OF A XEROX B405DN COPIER FOR 2JC,		N	E
JUD 320	A	64.14	O/M	3,848.40	2,966.64	10/12/2018	12/1/2018	11/30/2023	XEROX CORPORATION	LEASE OF A XEROX B405DN COPIER FOR 2JC,		N	E
JUD 320	A	264.23	O/M	12,778.80	5,908.95	8/16/2016	8/16/2016	8/15/2021	XEROX CORPORATION	60 MO.LEASE OF XEROX WC5955 COPIER		N	E
JUD 320	A	30,134.80	A	30,134.80	-	5/16/2019	6/1/2019	5/31/2020	JUSTICE AV SOLUTIONS	MAINTENANCE OF JAVS SYSTEM FOR HOAPILI HALE		N	S
JUD 320	A	3,400.00	A	3,400.00	3,400.00	10/4/2019	12/1/2019	11/30/2020	JUSTICE AV SOLUTIONS	MAINTENANCE OF JAVS SYSTEM FOR MOLOKAI D		N	S
JUD 320	A	4,510.00	A	4,510.00	4,510.00	10/4/2019	12/1/2019	11/30/2020	JUSTICE AV SOLUTIONS	MAINTENANCE OF JAVS SYSTEM AT LAHAINA DC		N	S
JUD 320	A	305.01	M	9,313.92	7,788.86	9/9/2019	9/1/2019	8/31/2020	PACIFIC COURIER	ARMORED CAR SERVICE FOR HOAPILI HALE AND LAHDC		N	S
JUD 320	A	268.19	M	16,091.40	7,018.46	11/11/2016	1/8/2017	1/7/2022	PITNEY BOWES INC.	MAIL SYSTEM FOR 2CC-WAILUKU		N	E
JUD 320	A	238.10	O/M	17,576.83	11,110.57	4/27/2018	4/27/2018	4/26/2022	XEROX CORPORATION	48 MONTH LEASE OF XEROX B8075H COPIER		N	E
JUD 320	A	4,973.53	O/M	234,743.30	172,730.09	11/8/2018	1/1/2019	12/31/2020	OAHU AIR CONDITIONING SERVICE,	MAINTENANCE OF AIR CONDITIONING SYSTEM A		N	S
JUD 320	A	1,585.15	M	95,109.00	79,257.60	12/17/2018	1/1/2019	12/31/2023	THYSSENKRUPP ELEVATOR	MAINTENANCE OF THYSSEN ELEVATORS AT HOAP		N	S
JUD 320	A	661.38	O - QTR	13,227.60	3,243.90	9/1/2019	9/1/2019	8/31/2024	THYSSENKRUPP ELEVATOR	MAINT OF 2 DUMBWAITERS - HOAPILI HALE		N	S
JUD 320	A	16,328.00	A	16,328.00	-	6/9/2019	7/1/2019	6/30/2020	L-3 COMMUNICATIONS SECURITY	MAINTENANCE OF L-3 COMMUNICATIONS SECURI		N	S
JUD 320	A	1,219.28	O	7,315.65	4,877.11	4/26/2019	7/1/2019	6/30/2020	JOHNSON CONTROLS	MAINTENANCE OF FIRE ALARM AND SECURITY S		N	S
JUD 320	A	27,618.57	O	27,618.57	-	7/31/2019	9/1/2019	8/31/2020	SECURITY RESOURCES LLC	MAINTENANCE OF SECURITY EQUIPMENT		N	S
JUD 320	A	2,430.00	A	2,430.00	-	5/17/2017	7/1/2019	6/30/2020	CLEARVIEW	COSTAR SOFTWARE MAINTENANCE		N	S
JUD 320	A	15,541.56	O	15,541.56	-	8/24/2017	9/19/2017	9/18/2020	HAWAIIAN TELCOM	LIFESIZE EXTENDED WARRANTY (RURAL COURTS)		N	S
JUD 320	A	16,400.94	O	16,400.94	-	9/6/2018	9/24/2018	9/23/2021	HAWAIIAN TELCOM	LIFESIZE EXTENDED WARRANTY (HOAPILI HALE)		N	S
JUD 320	A	501.04	M	18,037.44	11,523.92	9/7/2018	11/1/2018	11/1/2021	KING POWER	MAINTENANCE OF EMERGENCY STANDBY GENERATOR		N	S
JUD 320	A	539.47	M	6,473.64	4,315.76	5/16/2019	7/1/2019	6/30/2020	ALOHA WASTE SYSTEMS,. INC.	REFUSE & RECYCLING SERVICES FOR HOAPILI HALE		N	S
JUD 320	A	3,685.80	O/M	104,272.78	89,529.59	4/2/2019	7/1/2019	6/30/2021	ACCESS INFORMATION MANAGEMENT	RECORDS STORAGE & RETRIEVAL SVCS THRU IF		N	S
JUD 320	A	764.96	O/M	9,300.00	6,240.15	3/8/2017	7/1/2019	6/30/2020	ACCESS INFORMATION MANAGEMENT	RECORDS SHREDDING SERVICE		N	S
JUD 320	A	1,953.26	O - QTR	7,813.04	5,859.86	4/18/2019	7/1/2019	6/30/2020	TERMINIX	QUARTERLY INTERIOR/EXTERIOR PEST CONTROL		N	S
JUD 320	A	19,537.33	O/M	229,476.87	151,327.57	7/1/2015	7/1/2019	6/30/2020	G4S SECURE SOLUTIONS (USA) INC	STATWIDE SECURITY SERVICES @CC2		N	S
JUD 320	A	3,208.12	O	3,208.12	-	7/17/2019	8/9/2019	8/8/2021	DELL MARKETING L.P.	EXTENDED WARRANTY		N	S
JUD 320	A	4,882.00	M	282,188.00	141,264.00	3/14/2012	2/16/2017	1/15/2022	UNION LEASING CORP FKA KAUNAKAKAI A	OFFICE SPACE RENTAL FOR MOLOKAI CLIENT SERVICE		N	L
JUD 320	A	24,055.73	M	1,419,288.07	1,347,117.76	9/4/2019	9/1/2019	7/31/2024	A & B PROPERTIES, INC.	OFFICE LEASE - ACS		N	L
JUD 320	A	8,895.78	M	533,454.99	216,787.32	12/28/2012	12/1/2016	10/31/2021	MAUI OFFICE, LLC. DBA 2200 MAIN, LLC	MAUI DRUG COURT LEASE		N	L
JUD 320	A	107.08	O/M	6,561.60	6,007.17	7/10/2018	7/10/2018	7/9/2023	KONICA MINOLTA	5 YEAR LEASE OF KONICA BIZHUB 368E		N	E
JUD 320	A	49.92	O/M	2,995.20	2,995.20	7/31/2019	10/10/2019	10/9/2024	XEROX CORPORATION	LEASE OF A XEROX B405DN COPIER FOR 2JC,		N	E
JUD 320	A	558.73	O/M	17,371.85	8,990.84	8/1/2017	8/1/2017	7/31/2022	XEROX CORPORATION	5YR LEASE OF XEROX WORKCENTRE C8055H		N	E
JUD 320	A	150.03	O/M	14,127.30	2,860.95	7/1/2015	7/1/2015	6/30/2020	XEROX CORPORATION	5YR LEASE OF XEROX W7835PT COPIER		N	E
JUD 320	A	197.42	O/M	19,045.42	7,971.77	12/9/2016	1/11/2017	1/10/2022	XEROX CORPORATION	5YR LEASE OF XEROX COLORQUBE 9303 COPIER		N	E
JUD 320	A	660.53	O/M	24,339.74	11,789.67	2/7/2017	4/1/2017	3/31/2022	XEROX CORPORATION	5YR LEASE OF XEROX COLORQUBE 9303 COPIER		N	E

Judiciary
Active Contracts as of December 1, 2019

Table 14

Prog ID	MOF	Amount	Frequency (M/A/O)	Max Value	Outstanding Balance	Date Executed	From	To	Entity	Contract Description	Explanation of How Contract is Monitored*	POS Y/N	Category E/L/P/C/G/S/*
JUD 320	A	400.00	O	6,000.00	5,600.00	7/25/2019	7/15/2019	6/30/2020	AKAHAI COUNSELING LLC	CC2 SUBSTANCE ABUSE ASSESSMENT		Y	S
JUD 320	A	498.75	O/M	90,000.00	88,005.00	5/22/2019	7/1/2019	6/30/2021	ALOHA HOUSE, INC.	CC2 ADULT SUBSTANCE ABUSE TREATMENT		Y	S
JUD 320	A	7,205.38	O/M	162,000.00	133,178.50	5/22/2019	7/1/2019	6/30/2021	ALOHA HOUSE, INC.	CC2 ADULT SUBSTANCE ABUSE TREATMENT		Y	S
JUD 320	A	43,189.97	O/M	1,300,000.00	477,240.13	6/11/2019	7/1/2019	6/30/2021	ALOHA HOUSE, INC.	CC2 ADULT SUBSTANCE ABUSE TREATMENT		Y	S
JUD 320	A	3,743.33	O	100,000.00	88,770.00	6/11/2019	7/1/2019	6/30/2021	COMMUNITY ASSISTANCE CENTER	CC2 ADULT SEX OFFENDER TREATMENT		Y	S
JUD 320	A	4,350.00	O/M	134,000.00	120,950.00	9/26/2019	7/1/2019	6/30/2021	MOLOKAI COMMUNITY SERVICE COUNCIL	CC2 DOMESTIC VIOLENCE INTERVENTION		Y	S
JUD 320	A	800.00	O	5,000.00	4,200.00	5/28/2019	7/1/2019	6/30/2021	MOLOKAI COMMUNITY SERVICE COUNCIL	CC2 JUVENILE IN-COMMUNITY SVCS		Y	S
JUD 320	A	1,250.00	O/M	34,800.00	34,800.00	9/10/2019	9/1/2019	6/30/2021	MOLOKAI COMMUNITY HEALTH CENTER	CC2 JUVENILE SUBSTANCE ABUSE TREATMENT		Y	S
JUD 320	A	1,500.00	M	36,000.00	30,000.00	6/18/2019	7/1/2019	6/30/2021	KA HALE POMAIIKAI	CC2 ADULT SUBSTANCE ABUSE TREATMENT		Y	S
JUD 320	A	1,250.00	M	30,000.00	25,000.00	6/11/2019	7/1/2019	6/30/2021	LANAI COMMUNITY HEALTH CENTER	CC2 ADULT SUBSTANCE ABUSE TREATMENT		Y	S
JUD 320	A	43.00	O	30,000.00	30,000.00	5/22/2019	7/1/2019	6/30/2021	MALAMA FAMILY RESOURCE CENTER	CC2 ADULT SUBSTANCE ABUSE TREATMENT		Y	S
JUD 320	A	2,182.25	O	60,000.00	51,271.00	5/22/2019	7/1/2019	6/30/2021	MALAMA FAMILY RESOURCE CENTER	CC2 INTEGRATED SUBSTANCE ABUSE TREATMENT		Y	S
JUD 320	A	2,417.50	O/M	84,000.00	74,330.00	4/29/2019	7/1/2019	6/30/2021	LOVE COUNSELING AND CONSULTING LLC	CC2 JUVENILE SEX OFFENDER TREATMENT		Y	S
JUD 320	A	972.17	O	10,000.00	7,083.50	5/22/2019	7/1/2019	6/30/2021	MAUI YOUTH & FAMILY SERVICES,	CC2 INTEGRATED SUBSTANCE ABUSE TREATMENT		Y	S
JUD 320	A	1,876.81	O	28,000.00	20,492.75	5/22/2019	7/1/2019	6/30/2021	MAUI YOUTH & FAMILY SERVICES,	CC2 JUVENILE SUBSTANCE ABUSE TREATMENT		Y	S
JUD 320	A	500.00	O/M	30,000.00	28,500.00	6/11/2019	7/1/2019	6/30/2021	OHANA MAKAMAE	CC2 DOMESTIC VIOLENCE INTERVENTION		Y	S
JUD 320	A	150.00	O	8,000.00	7,850.00	5/30/2019	7/1/2019	6/30/2021	NA PU'UWAI	CC2 ADULT SUBSTANCE ABUSE TREATMENT		Y	S
JUD 320	A	15,071.67	O/M	651,250.00	606,035.00	5/22/2019	7/1/2019	6/30/2021	PACT-FAMILY PEACE CENTER	CC2 DOMESTIC VIOLENCE INTERVENTION SVCS		Y	S
JUD 320	A	900.00	O/M	28,000.00	27,100.00	5/28/2019	7/1/2019	6/30/2021	PACT-FAMILY PEACE CENTER	CC2 IN-COMMUNITY SERVICES		Y	S
JUD 320	A	9,664.75	O/M	188,000.00	140,341.00	9/26/2019	7/1/2019	6/30/2021	WOMEN HELPING WOMEN	CC2 DOMESTIC VIOLENCE INTERVENTION		Y	S
JUD 320	A	1,010.85	O	17,000.00	13,967.45	7/1/2019	7/1/2019	6/30/2021	TECHNICAL RESOURCE MANAGEMENT, LLC	DRUG TESTING FOR ADULT CLIENTS		N	S
JUD 320	A	1,443.38	O	36,000.00	30,226.50	11/1/2015	7/1/2019	6/30/2021	DIAGNOSTIC LABORATORY SERVICES, INC	STATEWIDE DRUG COLLECTION, SCREENING & CONFIRM		N	S
JUD 320	A	2,500.00	O	125,000.00	76,513.15	4/19/2019	7/1/2019	6/30/2020	FOSTER-AU, RENATA	GAL FOR 2ND CIRCUIT		N	S
JUD 320	A	2,500.00	O	150,000.00	101,667.50	4/19/2019	7/1/2019	6/30/2020	BAKER, JOHN J.	GAL FOR 2ND CIRCUIT		N	S
JUD 320	A	2,500.00	O	120,000.00	101,747.30	5/22/2019	7/1/2019	6/30/2020	LEGAL AID SOCIETY OF HAWAII	GAL FOR 2ND CIRCUIT		N	S
JUD 320	A	2,500.00	O	120,000.00	96,624.13	4/19/2019	7/1/2019	6/30/2020	TENGAN, DAVELYNN	GAL FOR 2ND CIRCUIT		N	S
JUD 320	A	2,500.00	O	125,000.00	99,280.00	5/16/2019	7/1/2019	6/30/2020	LOWENTHAL AND LOWENTHAL	GAL FOR 2ND CIRCUIT		N	S
JUD 320	A	2,500.00	O	125,000.00	57,760.64	4/19/2019	7/1/2019	6/30/2020	NICOLE FORELLI	GAL FOR 2ND CIRCUIT		N	S
JUD 320	A	2,500.00	O	100,000.00	85,041.00	4/19/2019	7/1/2019	6/30/2020	BARBARA SAUER	GAL FOR 2ND CIRCUIT		N	S
JUD 320	A	16,574.25	A	16,574.25	16,574.25	8/26/2019	8/26/2019	12/11/2019	SBL SOLUTIONS LLC	TRAFFIC CITATIONS		N	S
JUD 320	A	36,540.00	A	36,540.00	-	7/1/2019	7/1/2019	11/30/2019	EMSS INC	JUROR QUESTIONNAIRES PRINTING AND MAILING		N	S
JUD 320	A	6,350.00	A	6,350.00	-	7/1/2019	7/1/2019	6/30/2020	SIMS HAWAII ENTERPRISES	OPEN AND SCAN JUROR QUESTIONNAIRES		N	S
JUD 320	A	186.26	O - QTR	3,725.40	3,539.04	8/30/2017	8/30/2017	8/29/2022	PITNEY BOWES INC.	MAIL SYSTEM FOR LAHAINA DISTRICT COURT		N	S
JUD 320	A	1,577.60	O/M	98,131.11	74,467.22	7/1/2018	9/1/2018	7/31/2023	LANAI RESORTS, LLC	OFFICE LEASE FOR LANAI DISTRICT COURT.		N	L
JUD 320	A	117.28	O/M	8,857.20	2,633.18	3/15/2016	3/15/2016	3/14/2021	RICOH USA	LEASE RICOH M5054 COPIER 3RD FLOOR		N	E
JUD 320	A	154.50	O/M	9,616.80	2,953.93	1/27/2016	1/27/2016	1/26/2021	XEROX CORPORATION	LEASE OF XEROX W5945COPIER FOR LAHAINA DC		N	E
JUD 320	A	76.74	O/M	5,089.20	1,775.82	8/4/2016	8/4/2016	8/3/2021	RICOH USA	LEASE RICOH MP3054 COPIER MOLOKAI DC		N	E
JUD 320	A	76.74	O/M	4,893.60	1,678.16	8/16/2016	8/16/2016	8/15/2021	RICOH USA	LEASE RICOH MP3054 COPIER LANAI DC		N	E
JUD 320	A	100.89	O/M	7,764.60	652.54	8/1/2015	8/1/2015	7/31/2020	RICOH USA	5YR LEASE OF RICOH MP3054 COPIER FOR FAMILY COURT		N	E
JUD 320	A	150.73	O/M	28,904.40	9,762.98	12/10/2015	12/10/2015	12/9/2020	XEROX CORPORATION	LEASE OF XEROX W7838 COPIER FOR SERVICE CENTER		N	E
JUD 320	A	111.24	O/M	7,748.06	4,351.45	8/29/2017	8/29/2017	8/28/2022	XEROX CORPORATION	VEND COPIER FOR 2ND CIRCUIT'S SERVICE CENTER		N	E
JUD 320	A	26.07	O/M	1,964.85	1,074.08	7/31/2017	7/31/2017	7/30/2022	XEROX CORPORATION	LEASE XEROX B405DN FAX FOR SERVICE CENTER		N	E
JUD 320	A	238.10	O/M	15,480.19	9,731.08	4/27/2018	4/27/2018	4/26/2022	XEROX CORPORATION	LEASE XEROX B8075DN FOR LEGAL DOCUMENTS		N	E
JUD 320	A	1,822.91	A	1,822.91	-	3/20/2019	4/15/2019	4/14/2020	ADVANCES MICRO-IMAGE SYSTEMS	MAINT OF MINOLTA IMAGING SYSTEM-2ND CC		N	S
JUD 320	A	365.08	O/M	5,887.52	4,055.56	4/19/2019	7/1/2019	6/30/2020	STURDEVANT REFRIGERATION & AIR	A/C MAINTENANCE AT LAHAINA DC		N	S
JUD 320	A	8,294.00	O - QTR	33,176.00	8,294.00	4/30/2019	5/15/2019	5/14/2020	HONEYWELL INTERNATIONAL, INC.	SERVICE/MAINT OF FIRE ALARM/SECURITY SYS		N	S
JUD 320	A	67.71	M	812.52	541.68	4/5/2019	7/1/2019	6/30/2020	MAUI DISPOSAL	REFUSE SERVICE - LAHAINA DC		N	S
JUD 320	A	194.96	O	20,000.00	17,465.52	6/14/2019	7/1/2019	6/30/2020	ELIZABETH KELLY	TRANSCRIPTION SERVICE		N	S
JUD 320	A	637.66	M	21,600.00	2,007.33	2/1/2003	2/1/2017	1/31/2020	VERIZON WIRELESS	CELL PHONE SERVICE		N	S
JUD 320	A	1,550.59	M	32,400.00	7,590.60	7/1/1991	7/1/2017	6/30/2020	BANK OF HAWAII	CREDIT CARD SERVICE		N	S
JUD 320	A	774.91	O	9,298.92	6,199.28	7/1/2019	7/1/2019	6/30/2020	BEN ACOB	GRAND JURY COUNSEL		N	S
JUD 320	A	774.91	O	9,298.92	8,524.01	7/1/2019	7/1/2019	6/30/2020	CAROLINE BELSOM	GRAND JURY COUNSEL		N	S
JUD 330	A	2,932.64	M	173,092.00	170,093.12	11/1/2014	11/1/2019	9/30/2024	1284 KILAUEA K&M, LLC	STORAGE SPACE FOR CC3		N	L
JUD 330	A	774.91	O - DAY	18,597.84	10,073.83	7/1/2019	7/1/2019	6/30/2020	ASHIDA, LINCOLN	FY20 GRAND JURY COUNSEL CC3		N	C
JUD 330	A	1,216.72	M - EST	36,000.00	10,950.50	1/1/1981	8/1/2017	7/31/2020	BANK OF HAWAII	STATEWIDE CREDIT CARD SERVICE		N	S
JUD 330	A	2,862.10	M	67,369.44	17,172.60	6/7/2011	7/1/2018	6/30/2020	BURITZ, BHAGAVAN S.	LEASE- STORAGE OF FILES, EQUIPMENT		N	L
JUD 330	A	621.04	M - EST	7,452.49	7,452.49	11/1/2019	11/1/2019	10/31/2020	C. W. MAINTENANCE, INC.	JANITORIAL SERVICES KAMUELA JUVENILE/ADU		N	S
JUD 330	A	5,586.59	M	200,592.36	33,271.68	1/1/2003	7/1/2017	6/30/2020	CARTER PROFESSIONAL CENTER	OFFICE LEASE FC3		N	L
JUD 330	A	349,357.00	O - NTE/YR	764,077.00	549,762.00	7/1/2019	7/1/2019	6/30/2021	CHILDREN'S LAW PROJECT	GUARDIAN LITEM/LEGAL COUNSEL SERVICES		N	C

Judiciary
Active Contracts as of December 1, 2019

Prog ID	MOF	Amount	Frequency (M/A/O)	Max Value	Outstanding Balance	Date Executed	From	To	Entity	Contract Description	Explanation of How Contract is Monitored*	POS Y/N	Category E/L/P/C/G/S/*
JUD 330	A	292,250.00	O - NTE/YR	565,328.00	382,648.00	7/1/2019	7/1/2019	6/30/2021	CHUNG, AARON S. Y.	GUARDIAN LITEM/LEGAL COUNSEL SERVICES		N	C
JUD 330	A	1,500.00	O	3,000.00	3,000.00	7/1/2019	7/1/2019	6/30/2021	DIAGNOSTIC LABORATORY SERVICES	STATEWIDE DRUG SCREENING & CONFIRMATION TESTING		N	S
JUD 330	A	45,675.00	O - NTE	45,675.00	0.00	7/1/2018	7/1/2019	11/30/2020	EMSS, INC.	FABRICATE, PRINT & MAILOUT JUROR QUESTION - STATEWIDE		N	S
JUD 330	A	76,518.00	O - NTE/YR	208,143.00	205,693.00	7/1/2019	7/1/2019	6/30/2021	FREEMAN, ALYSA B, P.C.	GUARDIAN LITEM/LEGAL COUNSEL SERVICES		N	C
JUD 330	A	774.91	O - DAY	9,298.92	6,199.28	7/1/2019	7/1/2019	6/30/2020	FREITAS, SANDRA L.S.	FY20 GRAND JURY COUNSEL CC3		N	C
JUD 330	A	55,664.03	M - EST	780,963.60	389,648.20	7/1/2015	7/1/2019	6/30/2020	G4S SECURE SOLUTIONS (USA) INC	STATWIDE SECURITY SERVICES CONTRACT		N	S
JUD 330	A	142,051.00	O - NTE/YR	295,361.00	236,796.00	7/1/2019	7/1/2019	6/30/2021	HEIMGARTNER, JENNIFER A.S.	GUARDIAN LITEM/LEGAL COUNSEL SERVICES		N	C
JUD 330	A	110,754.00	O - NTE/YR	242,550.00	198,780.00	7/1/2019	7/1/2019	6/30/2021	HEIMGARTNER, R. HERMANN	GUARDIAN LITEM/LEGAL COUNSEL SERVICES		N	C
JUD 330	A	76,518.00	O - NTE/YR	208,143.00	182,628.00	7/1/2019	7/1/2019	6/30/2021	HENRY, DAWN AAL	GUARDIAN LITEM/LEGAL COUNSEL SERVICES		N	C
JUD 330	A	108,288.00	O - NTE/YR	239,913.00	173,268.00	7/1/2019	7/1/2019	6/30/2021	IMUA LAW OFFICES LLLC	GUARDIAN LITEM/LEGAL COUNSEL SERVICES		N	C
JUD 330	A	5,675.20	O-SEMIANNL	11,523.76	5,675.20	7/1/2019	7/1/2019	6/30/2020	ISLAND CONTROLS INC.	ENERGY MANAGEMENT SYSTEM		N	S
JUD 330	A	153,409.00	O - NTE/YR	306,886.00	241,821.00	7/1/2019	7/1/2019	6/30/2021	JACKSON, JOAN	GUARDIAN LITEM/LEGAL COUNSEL SERVICES		N	C
JUD 330	A	11,936.84	A	11,936.84	0.00	7/1/2019	7/1/2019	6/30/2020	JOHNSON CONTROLS FIRE	CC3 FIRE ALARM & SPRINKLER MAINTENANCE		N	S
JUD 330	A	441.68	A	2,995.70	1,766.72	7/1/2019	7/1/2019	6/30/2024	JOHNSON CONTROLS FIRE	CC3 HJC FIRE ALARM MAINTENANCE		N	S
JUD 330	A	638.51	A	2,995.70	2,554.02	7/1/2019	7/1/2019	6/30/2024	JOHNSON CONTROLS FIRE	CC3 FIRE ALARM MAINTENANCE KONA COURTHOUSE		N	S
JUD 330	A	193,001.00	O - NTE/YR	392,306.00	297,191.00	7/1/2019	7/1/2019	6/30/2021	KITAOKA, CAROL	GUARDIAN LITEM/LEGAL COUNSEL SERVICES		N	C
JUD 330	A	15,857.96	A	15,857.96	0.00	7/1/2019	7/1/2019	6/30/2020	L-3 COMMUNICATIONS SECURITY	SECURITY XRAY MAINT FOR CT FACILITIES		N	S
JUD 330	A	158,246.00	O - NTE/YR	338,345.00	286,560.00	7/1/2019	7/1/2019	6/30/2021	LEGAL AID SOCIETY OF HAWAII	GAL/ LEGAL COUNSEL SERVICES FOR FC3		N	C
JUD 330	A	8,880.90	M	201,750.00	177,618.00	7/1/2019	7/1/2019	6/30/2021	OAHU AIR CONDITION SERVICE,INC	A/C MAINTENANCE SERVICE FOR HILO JUDICIA		N	S
JUD 330	A	2,012.19	M - EST	43,581.00	16,097.51	7/1/2018	7/1/2018	6/30/2020	PACIFIC COURIER	FY19-20 CC3 ARMORED TRANSPORT SERVICE		N	S
JUD 330	A	838.64	M	9,605.16	7,547.79	8/16/2019	8/16/2019	8/15/2020	PACIFIC WASTE INC.	REFUSE REMOVAL KEAHUOLU COURTHOUSE		N	S
JUD 330	A	31,098.55	O - NTE	31,098.55	31,098.55	8/26/2019	8/26/2019	12/11/2019	SBL SOLUTIONS LLC	IFB STATEWIDE PURCH OF TRAFFIC CITATIONS		N	S
JUD 330	A	10,970.10	M-EST	131,641.20	28,096.18	8/1/2019	8/1/2019	7/31/2020	SCHATTAUER FAMILY PROPERTY	LEASE OFFICE SPACE FOR BI DRUG CRT		N	L
JUD 330	A	3,342.72	M - EST	40,850.94	26,741.78	7/1/2018	7/1/2019	6/30/2020	SECURITY ARMORED CAR & COURIER	FY19 COURIER SERVICE INTRA-CIRCUIT 3JC		N	S
JUD 330	A	8,093.99	A	8,093.99	8,093.99	11/1/2018	11/1/2019	10/31/2020	SECURITY RESOURCES PACIFIC INC	CC3 ACCESS CONTROL AND SURVELLANCE SYSTEM HILO		N	S
JUD 330	A	284.51	M - EST	16,435.00	2,276.04	7/1/2017	7/1/2017	12/31/2019	SENTINEL OFFENDER SERVICES	FY18/19/20 STATEWIDE ELECTRONIC MONITORING		N	S
JUD 330	A	705.00	M - EST	23,575.75	7,755.01	10/1/2017	10/1/2017	9/30/2020	SERVICES HAWAII RUBBISH	10/2017 TO 09/2020 REFUSE SERVICE HILO		N	S
JUD 330	A	200.00	M	2,400.00	1,000.00	4/1/2019	4/1/2019	3/31/2020	SERVICES HAWAII RUBBISH	HAUL GREENWASTE HILO		N	S
JUD 330	A	7,852.00	A	7,852.00	7,852.00	7/1/2018	7/1/2019	6/30/2020	SIMS HAWAII CONSULTING, INC.	FY20 JUROR QUESTIONNAIRE SCANNING - STATEWIDE		N	S
JUD 330	A	12,957.00	A	12,957.00	0.00	8/1/2019	8/1/2019	7/31/2020	SMITHS DETECTION, INC.	FY19 X-RAY SCANNERS MAINTENANCE HILO		N	S
JUD 330	A	255.00	O - DAY	3,500.00	3,245.00	2/1/2019	2/1/2019	1/31/2020	SOUZA, MERCEDES SHARON	CC3 COURT REPORTER SERVICES		N	S
JUD 330	A	62,000.00	O - NTE/YR	124,000.00	112,039.00	7/1/2019	7/1/2019	6/30/2021	TECHNICAL RESOURCE	STATEWIDE DRUG SCREENING & CONFIRMATION TESTING		N	S
JUD 330	A	177,842.00	O - NTE/YR	346,268.00	207,163.00	7/1/2019	7/1/2019	6/30/2020	THOENE, ALIKA	GAL SERVICES		N	C
JUD 330	A	2,052.82	O - MON	73,224.12	53,373.20	1/1/2016	1/1/2019	12/31/2021	THOMSON REUTERS - WEST	WESTLAW SUBSCRIPTION FOR CC3 - STATEWIDE		N	S
JUD 330	A	29,847.53	A	89,542.59	0.00	7/1/2014	7/1/2017	6/30/2020	THYSSENKRUPP ELEVATOR CORP	ELEVATOR MAINTENANCE		N	S
JUD 330	A	333.37	M - EST	17,515.60	4,333.80	12/1/2015	12/1/2015	11/30/2020	XEROX CORPORATION	60 MON XEROX W7845PT KONA ACS, PSI		N	E
JUD 330	A	325.53	M - EST	13,146.20	4,231.92	12/1/2015	12/1/2015	11/30/2020	XEROX CORPORATION	60 MON XEROX 5945APT KONA ACS SUPRVISION		N	E
JUD 330	A	784.36	M - EST	32,195.60	10,196.62	12/1/2015	12/1/2015	11/30/2020	XEROX CORPORATION	60 MON XEROX D95CP KONA DC3 CRT		N	E
JUD 330	A	318.56	M - EST	11,829.40	4,141.26	12/1/2015	12/1/2015	11/30/2020	XEROX CORPORATION	60 MON XEROX 5945APT KONA FC CRT/JUDGE		N	E
JUD 330	A	92.34	M - EST	13,399.32	1,292.72	12/1/2015	1/1/2016	12/31/2020	XEROX CORPORATION	60 MON XEROX WC4265X HILO DC LDB		N	E
JUD 330	A	392.67	M - EST	9,567.60	5,495.91	12/1/2015	1/1/2016	12/31/2020	XEROX CORPORATION	60 MON XEROX WC4265X HILO PRGM SERV		N	E
JUD 330	A	199.56	M - EST	10,602.24	2,793.82	12/1/2015	1/1/2016	12/31/2020	XEROX CORPORATION	60 MON XEROX WC4265X HILO DC CRTRM 2B		N	E
JUD 330	A	158.33	M - EST	8,866.40	2,216.66	12/1/2015	1/1/2016	12/31/2020	XEROX CORPORATION	60 MON XEROX W4265X HILO DC CRTRM 2C		N	E
JUD 330	A	120.63	M - EST	8,822.00	1,930.06	3/1/2016	3/1/2016	2/28/2021	XEROX CORPORATION	60 MON XEROX WC5335PT KONA LAW LIBRARY		N	E
JUD 330	A	92.30	M - EST	5,308.80	1,476.76	3/1/2016	3/1/2016	2/28/2021	XEROX CORPORATION	60 MON LEASE XEROX KONA DC FAX		N	E
JUD 330	A	595.60	M - EST	33,416.40	21,441.64	11/1/2017	11/1/2017	10/31/2022	XEROX CORPORATION	60 MON LEASE COPIER KONA COURT SERVICES		N	E
JUD 330	A	315.65	M - EST	18,880.51	11,363.54	11/1/2017	11/1/2017	10/31/2022	XEROX CORPORATION	60 MON LEASE COPIER S. KOHALA DC		N	E
JUD 330	A	279.24	M - EST	16,693.02	10,052.81	11/1/2017	11/1/2017	10/31/2022	XEROX CORPORATION	60 MON LEASE COPIER KONA DRUG COURT		N	E
JUD 330	A	307.95	M - EST	16,693.02	11,086.08	11/1/2017	11/1/2017	10/31/2022	XEROX CORPORATION	60 MON LEASE COPIER KONA DIV 4		N	E
JUD 330	A	334.23	M - EST	18,880.51	12,032.23	11/1/2017	11/1/2017	10/31/2022	XEROX CORPORATION	60 MON LEASE COPIER KONA JCSB		N	E
JUD 330	A	128.76	M - EST	7,657.45	4,763.97	11/1/2017	12/1/2017	11/30/2022	XEROX CORPORATION	60 MON LEASE COPIER FAX KONA COURT SERVICES		N	E
JUD 330	A	792.46	M - EST	46,338.00	32,490.83	4/1/2018	4/1/2018	3/31/2023	XEROX CORPORATION	60 MON LEASE COPIER HILO CC3 LEGAL DOCS		N	E
JUD 330	A	341.43	M - EST	20,110.80	14,339.89	5/1/2018	5/1/2018	4/30/2023	XEROX CORPORATION	60 MON LEASE COPIER HILO CC3 ACS		N	E
JUD 330	A	269.13	M - EST	15,868.80	12,649.03	10/1/2018	10/1/2018	9/30/2023	XEROX CORPORATION	60 MON LEASE COPIER HILO FISCAL		N	E
JUD 330	A	226.81	M - EST	13,269.00	11,340.51	1/1/2019	1/1/2019	12/31/2023	XEROX CORPORATION	60-MONTH COPIER LEASE S.KOHALA		N	E
JUD 330	A	247.77	M - EST	14,814.00	13,875.38	7/1/2019	7/1/2019	6/30/2024	XEROX CORPORATION	CC3 COPIER LEASE DRUG COURT		N	E
JUD 330	A	293.97	M - EST	17,551.80	16,462.26	7/1/2019	7/1/2019	6/30/2024	XEROX CORPORATION	CC3 COPIER LEASE JUVENILE SERVICES		N	E
JUD 330	A	238.66	M - EST	14,280.00	13,603.60	8/1/2019	8/1/2019	7/31/2024	XEROX CORPORATION	CC3 COPIER LEASE HILO 2ND FLOOR WKRM		N	E
JUD 330	A	241.20	M - EST	14,467.80	13,748.25	8/1/2019	8/1/2019	7/31/2024	XEROX CORPORATION	CC3 COPIER LEASE 3RD FLOOR WKRM		N	E

Judiciary
Active Contracts as of December 1, 2019

Table 14

Prog ID	MOF	Amount	Frequency (M/A/O)	Max Value	Outstanding Balance	Date Executed	From	To	Entity	Contract Description	Explanation of How Contract is Monitored*	POS Y/N	Category E/L/P/C/G/S/*
JUD 330	A	248.25	M - EST	15,031.80	14,149.97	8/1/2019	8/1/2019	7/31/2024	XEROX CORPORATION	CC3 COPIER LEASE ADMIN WORKROOM 2ND FLOOR		N	E
JUD 330	A	360.13	M - EST	21,235.80	20,167.16	7/1/2019	7/1/2019	6/30/2024	XEROX CORPORATION	CC3 COPIER LEASE TVB CT RM SERVICES		N	E
JUD 330	A	27.21	M - EST	1,714.80	1,523.69	7/1/2019	7/1/2019	6/30/2024	XEROX CORPORATION	CC3 COPIER LEASE JURY/NOTARY ROOM		N	E
JUD 330	A	96.94	M - EST	5,689.20	5,428.63	7/1/2019	7/1/2019	6/30/2024	XEROX CORPORATION	CC3 COPIER LEASE CIRCUIT COURT JUDGE DIV 1		N	E
JUD 330	A	101.28	M - EST	6,096.60	5,773.10	8/1/2019	8/1/2019	7/31/2024	XEROX CORPORATION	CC3 COPIER LEASE 1ST FLOOR WORKROOM		N	E
JUD 330	A	97.15	M - EST	5,689.20	5,440.41	7/1/2019	7/1/2019	6/30/2024	XEROX CORPORATION	CC3 COPIER LEASE CIRCUIT COURT JUDGE DIV 2		N	E
JUD 330	A	143.73	M - EST	8,744.40	8,192.77	8/1/2019	8/1/2019	7/31/2024	XEROX CORPORATION	CC3 COPIER LEASE COURT REPORTERS #258		N	E
JUD 330	A	105.33	M - EST	6,218.40	5,898.36	7/1/2019	7/1/2019	6/30/2024	XEROX CORPORATION	CC3 COPIER LEASE DISTRICT COURT JUDGE'S #242		N	E
JUD 330	A	100.77	M - EST	6,006.60	5,743.83	8/1/2019	8/1/2019	7/31/2024	XEROX CORPORATION	CC3 COPIER LEASE DISTRICT COURT JUDGE'S #244		N	E
JUD 330	A	108.21	M - EST	6,498.00	6,168.20	8/1/2019	8/1/2019	7/31/2024	XEROX CORPORATION	CC3 COPIER LEASE DCCA RM 122		N	E
JUD 330	A	87.67	M - EST	5,159.40	4,996.94	8/1/2019	8/1/2019	7/31/2024	XEROX CORPORATION	CC3 COPIER LEASE HILO FACILITY MANAGEMEN		N	E
JUD 330	A	105.81	M - EST	6,218.40	6,031.38	8/1/2019	8/1/2019	7/31/2024	XEROX CORPORATION	CC3 COPIER LEASE HILO FC JUDGE 341		N	E
JUD 330	A	87.50	M - EST	5,185.80	4,987.26	8/1/2019	8/1/2019	7/31/2024	XEROX CORPORATION	CC3 COPIER LEASE HILO FC JUDGE 344		N	E
JUD 330	A	137.62	M - EST	8,197.20	7,982.21	9/1/2019	9/1/2019	8/31/2024	XEROX CORPORATION	CC3 COPIER LEASE - CIRCUIT DIV 3		N	E
JUD 330	A	137.62	M - EST	8,197.20	7,982.21	9/1/2019	9/1/2019	8/31/2024	XEROX CORPORATION	CC3 COPIER LEASE - CIR DIV 4		N	E
JUD 330	A	137.62	M - EST	8,197.20	7,982.21	9/1/2019	9/1/2019	8/31/2024	XEROX CORPORATION	CC3 COPIER LEASE - DIST JUDGE RM#2013		N	E
JUD 330	A	137.62	M - EST	8,197.20	7,982.21	9/1/2019	9/1/2019	8/31/2024	XEROX CORPORATION	CC3 COPIER LEASE - FAMILY JUDGE RM #2099		N	E
JUD 330	A	137.62	M - EST	8,197.20	7,982.21	9/1/2019	9/1/2019	8/31/2024	XEROX CORPORATION	CC3 COPIER LEASE - FACILITY MGMT RM 2071		N	E
JUD 330	A	137.62	M - EST	8,197.20	7,982.21	9/1/2019	9/1/2019	8/31/2024	XEROX CORPORATION	CC3 COPIER LEASE - PROGRAM SVCS RM 2036		N	E
JUD 330	A	10,000.00	O - NTE/YR	20,000.00	20,000.00	7/1/2019	7/1/2019	6/30/2021	ACCESS CAPABILITIES INC.	CC3 DOMESTIC VIOLENCE INTERVENTION		Y	S
JUD 330	A	35,000.00	O - NTE/YR	70,000.00	35,000.00	7/1/2019	7/1/2019	6/30/2021	ACCESS CAPABILITIES INC.	CC3 ADULT SUBSTANCE ABUSE TREATMENT AND SOBER		Y	S
JUD 330	A	2,000.00	O - NTE/YR	4,000.00	4,000.00	7/1/2019	7/1/2019	6/30/2021	ACCESS CAPABILITIES INC.	CC3 SUBSTANCE ABUSE TREATMENT - JUVENILE		Y	S
JUD 330	A	155,000.00	O - NTE/YR	310,000.00	166,657.00	7/1/2019	7/1/2019	6/30/2021	BIG ISLAND SUBSTANCE ABUSE	CC3 ADULT SUBSTANCE ABUSE TREATMENT		Y	S
JUD 330	A	100,000.00	M	200,000.00	175,000.01	7/1/2019	7/1/2019	6/30/2021	BRIDGE HOUSE, INC.	CC3 SOBER LIVING & ADULT SUBSTANCE ABUSE		Y	S
JUD 330	A	13,000.00	O - NTE/YR	26,000.00	26,000.00	7/1/2019	7/1/2019	6/30/2021	CARE HAWAII, INC.	CC3 ADULT SUBSTANCE ABUSE TREATMENT		Y	S
JUD 330	A	7,083.33	M	170,000.00	141,666.68	7/1/2019	7/1/2019	6/30/2021	CATHOLIC CHARITIES - CSATP	CC3 JUVENILE SEX OFFENDER TREATMENT SERV		Y	S
JUD 330	A	39,208.25	M	940,998.00	784,165.00	7/1/2019	7/1/2019	6/30/2021	CHILD & FAMILY SERVICE	CC3 DOMESTIC VIOLENCE INTERVENTION SVCS		Y	S
JUD 330	A	160,000.00	O - NTE	320,000.00	280,550.00	7/1/2019	7/1/2019	6/30/2021	COMMUNITY ASSISTANCE CENTER	CC3 ADULT SEX OFFENDER TREATMENT SERVICES		Y	S
JUD 330	A	20,000.00	O - NTE/YR	40,000.00	33,266.06	7/1/2019	7/1/2019	6/30/2021	LOKAHI TREATMENT CENTERS	CC3 ADULT SUBSTANCE ABUSE TREATMENT		Y	S
JUD 330	A	3,000.00	O - NTE/YR	6,000.00	6,000.00	7/1/2019	7/1/2019	6/30/2021	LOKAHI TREATMENT CENTERS	CC3 JUVENILE SUBSTANCE ABUSE TREATMENT		Y	S
JUD 330	A	60,000.00	O - NTE/YR	120,000.00	60,000.00	7/1/2019	7/1/2019	6/30/2021	LOKAHI TREATMENT CENTERS	CC3 DOMESTIC VIOLENCE INTERVENTION SVCS		Y	S
JUD 330	A	22,362.50	M	536,700.00	447,250.00	7/1/2019	7/1/2019	6/30/2021	SALVATION ARMY, THE	CC3 JUVENILE LONG TERM & EMERGENCY SHELTER		Y	S
JUD 330	A	625.00	O - FEE/ASSMT	12,500.00	9,375.00	7/1/2019	7/1/2019	6/30/2020	WINGERT, JOHN L., PH.D.	CC3 JV MENTAL HEALTH ASSESSMENT - Terminate 12/2019		Y	S
JUD 330	A	12,916.67	M	310,000.00	245,416.65	7/1/2019	7/1/2019	6/30/2021	YWCA OF HAWAII ISLAND	CC3 TEEN COURT ADMINISTRATION		Y	S
JUD 350	A	4,166.54	A	4,166.54	0.00	6/3/2019	7/5/2019	7/4/2020	ADVANCED MICRO-IMAGE SYSTEMS HI, INC	MAINTENANCE FOR (4) MICROFILMS		N	S
JUD 350	A	4,138.53	A	4,138.53	0.00	12/20/2018	12/15/2018	12/15/2019	AVR DISTRIBUTORS	FABRICATE, PRINT & DELIVER COURT FILE FOLDERS		N	S
JUD 350	A	795.81	M	9,549.72	5,570.67	3/8/2019	4/1/2019	3/31/2020	BLS & KTC INC	RFUSE COLLECTION		N	S
JUD 350	A	2,507.98	A	2,507.98	0.00	3/25/2019	5/18/2019	5/17/2020	EATON CORPORATION	SECURITY ALARM SYSTEM BATTERY MAINTENANCE		N	S
JUD 350	A	18,270.00	A	18,270.00	0.00	4/24/2019	7/1/2019	11/30/2020	EMSS, INC	FABRICATE, PRINT & MAIL JUROR QUESTIONNAIRES		N	S
JUD 350	A	14,967.54	M	180,873.60	135,970.98	10/1/2019	7/1/2019	6/30/2020	G4S SECURE SOLUTIONS (USA) INC.	STATEWIDE SECURITY SRVICES		N	S
JUD 350	A	1,250.65	O	5,002.60	868.38	12/17/2018	1/1/2019	12/31/2019	HAWTHORNE PACIFIC CORP	GENERATOR INSPECTION/MAINTENANCE		N	S
JUD 350	A	55,842.80	A	55,842.80	0.00	8/9/2019	9/1/2019	8/31/2020	JUSTICE AV SOLUTIONS	MAINTENANCE FOR JAVS RECORDING SYSTEM		N	S
JUD 350	A	7,210.50	A	7,210.50	0.00	5/28/2019	7/1/2019	6/30/2020	L-3 COMMUNICATIONS SECURITY	SECURITY SYSTEM MAINTENANCE		N	S
JUD 350	A	232,640.37	M	232,640.37	77,546.83	4/14/2018	7/1/2018	6/30/2020	OAHU AIR CONDITION SERVICE INC	MAINTENANCE & CHEMICAL WATER TREATMENT SERVICE		N	S
JUD 350	A	3,602.59	M	210,909.00	78,489.79	9/26/2019	9/15/2016	9/14/2021	OTIS ELEVATOR	ELEVATOR MAINTENANCE		N	S
JUD 350	A	498.90	M	6,324.00	3,829.50	5/28/2019	5/1/2019	4/30/2020	PACIFIC COURIER CORP	COURIER SERVICE		N	S
JUD 350	A	3,650.00	A	11,580.40	4,100.04	6/25/2018	6/23/2018	6/22/2021	PHOENIX PACIFIC, INC.	FIRE ALARM SYSTEM/BOOSTER PANEL MAINTENANCE		N	S
JUD 350	A	7,989.00	A	7,989.00	7,989.00	8/26/2019	8/26/2019	12/11/2019	SBL SOLUTIONS, LLC	FABRICATE, PRINT & DELIVER VARIOUS TRAFFIC CITATION FORMS		N	S
JUD 350	A	60,041.86	A	60,041.86	60,041.86	11/8/2019	11/17/2019	11/16/2020	SECURITY RESOURCES PACIFIC, INC.	ACCESS CONTROL SYSTEM/VIDEO SERVEILLANCE MAINT		N	S
JUD 350	A	3,116.00	A	3,116.00	3,116.00	4/24/2019	7/1/2019	6/30/2020	SIMS HAWAII ENTERPRISES	JUROR QUESTIONNAIRE PROCESSING/SCANNING		N	S
JUD 350	A	4,440.00	A	4,440.00	0.00	4/5/2019	5/17/2019	5/16/2020	SMITHS DETECTION, INC.	XRAY MACHINE MAINTENANCE		N	S
JUD 350	A	17.00	O - PER KIT	16,320.00	15,772.70	6/15/2019	7/1/2019	6/30/2021	TECHNICAL RESOURCEMGMT,LLC	STATWIDE DRUG CONFIRMATION TESTING		N	S
JUD 350	A	693.51	M	25,469.28	18,564.67	12/21/2017	1/1/2019	12/31/2021	THOMSON REUTERS-WEST	5JC WESTLAW SUBSCRIPTION		N	S
JUD 350	A	2,764.00	A	5,528.69	2,764.69	9/5/2019	10/1/2019	9/30/2020	TRANE US, INC.	MAINTENANCE: BUILDING AUTOMTION SYSTEM-A/C		N	S
JUD 350	A	283.04	M	16,982.40	2,523.84	11/10/2014	1/1/2014	12/30/2019	XEROX CORPORATION	(1) COPIER: BETWEEN CHAMBERS 4 & 6		N	E
JUD 350	A	284.04	M	16,982.40	432.84	12/12/2014	2/1/2014	1/30/2020	XEROX CORPORATION	(1) COPIER: PROBATION MAILROOM		N	E
JUD 350	A	194.78	M	11,686.80	1,677.48	5/13/2015	7/1/2015	6/30/2020	XEROX CORPORATION	(1) COPIER: FC		N	E
JUD 350	A	285.60	M	17,136.00	2,640.68	5/13/2015	7/1/2015	6/30/2020	XEROX CORPORATION	(8) COPY/FAX MACHINES (LDB, DRUG CRT, APD, FC & (4) CHAMBERS		N	E
JUD 350	A	471.58	M	28,294.80	11,244.17	11/1/2016	12/1/2016	11/30/2021	XEROX CORPORATION	2 COPIERS: ADM MAILROOM & BACK WORK ROOM		N	E

Judiciary
Active Contracts as of December 1, 2019

Table 14

Prog ID	MOF	Amount	Frequency (M/A/O)	Max Value	Outstanding Balance	Date Executed	From	To	Entity	Contract Description	Explanation of How Contract is Monitored*	POS Y/N	Category E/L/P/C/G/S/*
JUD 350	A	946.41	M	56,784.60	26,570.48	11/1/2016	12/1/2016	11/30/2021	XEROX CORPORATION	3 COPIERS: FISCAL, APD & DC CHAMBERS WORKROOM		N	E
JUD 350	A	358.68	M	21,520.80	12,678.60	11/14/2016	12/1/2016	11/30/2021	XEROX CORPORATION	LAW LIBRARY & 1ST FLR ADMIN (FISCAL)		N	E
JUD 350	A	120.00	O-PER UNIT RT	20,000.00	20,000.00	6/21/2019	7/1/2019	6/30/2021	CARE HAWAII, INC.	SUBSTANCE ABUSE TREATMENT-APD & DRUG COURT		Y	S
JUD 350	A	4,500.00	M	54,000.00	31,500.00	8/26/2019	7/1/2019	6/30/2020	CHILD & FAMILY SERVICE	GIRLS COURT THERAPIST-REIMBURSED BY OYS		Y	S
JUD 350	A	1,250.00	M	30,000.00	26,250.00	5/10/2019	7/1/2019	6/30/2021	HALE OPIO	FC5 TEEN COURT		Y	S
JUD 350	A	505.00	O-PER UNIT RT	3,030.00	3,030.00	5/10/2019	7/1/2019	6/30/2021	HALE OPIO	FC5 FAMILY CONFERENCING OUTPATIENT SVC		Y	S
JUD 350	A	362.00	O-PER UNIT RT	12,308.00	12,308.00	5/10/2019	7/1/2019	6/30/2021	HALE OPIO	FC5 VICTIM IMPACT OUTPATIENT CLASSES		Y	S
JUD 350	A	5,877.08	M	141,050.00	123,418.72	5/24/2019	7/1/2019	6/30/2021	KAUAI COUNTY YWCA	CC5 SEX OFFENDER TREATMENT		Y	S
JUD 350	A	13,219.83	M	317,314.00	277,654.51	5/29/2019	7/1/2019	6/30/2021	KAUAI COUNTY YWCA	CC5 DOMESTIC VIOLENCE INTERVENTION		Y	S
JUD 350	A	750.00	M	18,000.00	15,750.00	5/29/2019	7/1/2019	6/30/2021	KAUAI COUNTY YWCA	FC5 DOMESTIC VIOLENCE OUTPATIENT SVC		Y	S
JUD 350	A	2,083.33	M	24,999.99	18,750.00	5/29/2019	7/1/2019	6/30/2020	KAUAI COUNTY YWCA	FC5 TEEN ANGER MANAGEMENT		Y	S
JUD 350	A	5,166.74	M	124,000.00	108,500.02	6/4/2019	7/1/2019	6/30/2021	KAUAI COUNTY YWCA	FC5 SEX OFFENDER OUTPATIENT SVC		Y	S
JUD 350	A	75.00	O-PER UNIT RT	20,000.00	19,932.50	7/3/2019	7/1/2019	6/30/2021	GERALD J. MCKENNA DBA KEALA PONO	SUBSTANCE ABUSE TREATMENT-APD & DRUG COURT		Y	S
JUD 350	A	833.33	M	20,000.00	17,500.01	6/4/2019	7/1/2019	6/30/2021	PARENTS & CHILD TOGETHER	SUPERVISED CHILD VISITATION & EXCHANGE SERVICES		Y	S
JUD 350	A	150.00	O-PER UNIT RT	20,000.00	20,000.00	7/1/2019	7/1/2019	6/30/2021	WOMEN IN NEED	SUBSTANCE ABUSE TREATMENT-APD & DRUG COURT		Y	S
JUD 601	A	6,263.23	A	6,263.23	0.00	10/1/2004	8/1/2019	7/31/2020	MICRO FOCUS (US), INC.	ACUCOBOL MAINT FOR TRUST ACCTG (3 LIC)		N	S
JUD 601	A	VARIOUS	M	7,379.40	4,578.36	7/1/2011	7/1/2019	6/30/2020	ACCESS INFORMATION PROTECTED	STORAGE/TRANSPORTATION DATA BACKUP SVCS		N	S
JUD 601	A	32,413.50	A	33,940.82	0.00	3/1/2005	7/1/2019	6/30/2020	GOVERNMENTJOBS.COM, INC.	HR NEOGOV LICENSE SUBSCRIPTION		N	S
JUD 601	B	VARIOUS	M	660.00	494.12	10/1/2005	10/1/2019	9/30/2020	Verizon Wireless	TELEPHONE CHARGES ACCT#870528137-00002		N	S
JUD 601	A	VARIOUS	M	7,200.00	5,272.97	10/1/2005	10/1/2019	9/30/2020	VERIZON WIRELESS	MOBILE PHONES & IPHONES -ITCD		N	S
JUD 601	A	VARIOUS	M	9,345.00	7,417.97	10/1/2005	10/1/2019	9/30/2020	VERIZON WIRELESS	SMARTPHONE & IPHONE LIC FOR WIRELESS ACC		N	S
JUD 601	A	3,934.69	M	228,732.72	59,789.00	5/1/2016	5/1/2016	3/31/2021	DYNASTY COURT LLC	OFFICE LEASE CJC KAUAI		N	L
JUD 601	A	VARIOUS	M	12,500.00	8,251.25	9/24/2007	7/1/2019	6/30/2020	DATA HOUSE CONSULTING, INC.	IMPLEMENTATION OF ELS AND MAINTENANCE &		N	S
JUD 601	A	VARIOUS	M	1,960,641.70	1,485,095.50	11/1/2006	10/1/2018	8/31/2023	KAMEHAMEHA SCH	OFFICE LEASE FOR RECORDS MGT		N	L
JUD 601	A	4,350.00	A	4,350.00	4,350.00	2/1/2008	2/1/2019	1/31/2020	SHELL STREAM SOFTWARE LLC	WISP & KCSI SOFTWARE ANNUAL MAINTENANCE		N	S
JUD 601	A	1,000.00	O - QTR	4,000.00	2,000.00	1/4/2008	7/1/2019	6/30/2020	HAWAII INFORMATION CONSORTIUM,	JUD REF# FOR SPO VL 08-13 FOR INTERNET P		N	S
JUD 601	B	VARIOUS	M	24,806.69	1,517.18	12/11/2009	7/1/2019	6/30/2020	FIRST DATA GOVERNMENT SOLUTION	INTERACTIVE VOICE RESPONSE HARD/SOFT UPG		N	S
JUD 601	A	VARIOUS	O	117,277.44	117,277.44	11/1/2011	7/1/2019	6/30/2020	BUSINESS SOLUTION	BUSINESS SOL PEOPLESFT SOFTWARE		N	S
JUD 601	B	VARIOUS	M	93,929.00	54,635.35	10/3/2012	7/1/2017	2/28/2020	CAPGEMINI AMERICA INC.	TECHNICAL CONSULTING SVCS FOR JIMS		N	S
JUD 601	A	2,754.54	M	162,517.86	71,618.04	4/1/2017	4/1/2017	2/28/2022	TAVARES, EDMOND J. & EDWINA A.	OFFICE LEASE CJC MAUI		N	L
JUD 601	A	VARIOUS	M	1,225.00	1,189.35	7/1/2012	7/1/2015	6/30/2020	AMERICAN SAVINGS BANK	BANKING SERVICE (EDI) FOR OPG		N	S
JUD 601	A	VARIOUS	O	76,228.35	57,171.26	12/31/2013	7/1/2019	6/30/2020	ORACLE AMERICA, INC.	PEOPLESFT ENT SW FOR HR		N	S
JUD 601	A	4,012.26	M	145,002.78	4,012.26	1/1/2017	1/1/2017	12/31/2019	ST. ANDREW'S PRIORY SCHOOL	OFFICE LEASE CJC PALI		N	L
JUD 601	A	VARIOUS	M	75,000.00	62,763.75	9/24/2014	9/1/2019	8/31/2020	DATAHOUSE CONSULTING, INC.	RFP HAJIS/JUSTIS AND HO'OHKI SUPPORT		N	S
JUD 601	A	VARIOUS	O	307,860.00	212,695.87	1/13/2016	7/1/2019	12/31/2020	VERACITY CONSULTING, INC.	COMPUTER INFRASTRUCTURE CONSULTING & SUP		N	S
JUD 601	B	VARIOUS	O	65,000.00	65,000.00	1/13/2016	7/1/2019	12/31/2020	VERACITY CONSULTING, INC.	COMPUTER INFRASTRUCTURE CONSULTING & SUP		N	S
JUD 601	A	7,407.00	A	7,407.00	0.00	2/7/2015	2/7/2019	2/6/2020	EATON CORPORATION	EATON 9390 POWERWARE UPS MAINT AT DATA C		N	S
JUD 601	A	378,830.31	A	378,830.31	0.00	5/29/2015	5/29/2015	5/28/2020	MB FINANCIAL BANK, NA	5 YR STRAIGHT LEASE OF IBM ZBC12 MAINFRA		N	E
JUD 601	A	3,344.36	M	119,143.44	53,370.08	5/1/2018	5/1/2018	4/30/2021	LIPIN ENTERPRISES, INC.	OFFICE LEASE CJC KONA		N	L
JUD 601	A	VARIOUS	M	171,893.76	112,312.50	7/1/2019	7/1/2019	6/30/2020	G4S Secure Solution, Inc.	Security Services - Supreme Court & Kapuiwa		N	S
JUD 601	A	17,337.31	M	974,886.65	104,023.64	8/1/2015	8/1/2015	6/30/2020	DOUGLAS EMMETT 2010, LLC	ADLRO OFFICE LEASE ASB STE #500		N	L
JUD 601	A	209.21	M	12,552.60	2,092.10	10/1/2015	10/1/2015	9/30/2020	XEROX CORPORATION	60 MONTH LEASE XEROX CJC PALI		N	E
JUD 601	A	VARIOUS	O	17,286.44	3,389.26	7/1/2015	7/1/2015	6/30/2020	HAWTHORNE PACIFIC CORP.	CATERPILLAR GENERATOR MAINT AT DATA CENT		N	S
JUD 601	A	VARIOUS	O	2,500.00	2,500.00	7/1/2015	7/1/2019	6/30/2020	FUJIOKA, TERRY ANN, PH.D.	CJC CONSULTING AND SPECIALIZED INTERVIEW		N	S
JUD 601	A	7,750.45	M	433,076.56	72,735.10	11/1/2015	11/1/2015	9/30/2020	345 QUEEN STREET BUILDING, LLC	OFFICE LEASE OPG		N	L
JUD 601	A	239.86	M	14,391.60	3,366.00	12/1/2015	12/1/2015	11/30/2020	XEROX CORPORATION	60 MONTH XEROX ADLRO #1 XEROX MODEL 5890		N	E
JUD 601	A	160.46	M	9,627.60	1,765.00	12/1/2015	12/1/2015	11/30/2020	XEROX CORPORATION	60 MONTH XEROX ADLRO #2 XEROX MODEL 5945		N	E
JUD 601	A	VARIOUS	A	8,272.25	1,654.45	2/1/2016	2/1/2016	1/31/2021	ASCO SERVICES, INC.	5YR PWR SWCH MAINT, S#662852 WE @ITCD-B2		N	S
JUD 601	A	213.69	M	12,821.40	2,777.97	1/1/2016	1/1/2016	12/31/2020	XEROX CORPORATION	60 MONTH LEASE XEROX OPG		N	S
JUD 601	B	VARIOUS	M	658,616.72	210,444.44	7/1/2016	7/1/2019	6/30/2021	HAWAIIAN TELCOM	MULTIPROTOCOL LABLING SYS WIDE AREA NETW		N	S
JUD 601	A	109.91	M	6,609.00	2,212.60	9/1/2016	9/1/2016	8/31/2021	RICOH USA, INC.	60 MONTH COPIER LEASE FOR HISTORY CENTER		N	E
JUD 601	A	VARIOUS	O	55,000.00	0.00	5/3/2016	5/3/2016	5/31/2021	GALLAGHER KANE AMAI, ATTORNEYS	WORKERS COMPENSATION LEGAL COUNSEL		N	C
JUD 601	A	176.10	M	10,565.00	3,169.50	7/1/2016	7/1/2016	6/30/2021	XEROX CORPORATION	60 MONTH COPIER LEASE LCO OFFICE		N	E
JUD 601	A	103.57	M	6,214.20	1,968.50	6/2/2016	8/1/2016	7/31/2021	XEROX CORPORATION	5 YEAR LEASE OF W7220PT COPIER - PPEP		N	E
JUD 601	A	VARIOUS	O	9,000.00	6,636.14	7/1/2016	7/1/2019	6/30/2020	CHING, JUNE W. J., PH.D	CJC CONSULTING SERVICES		N	S
JUD 601	A	VARIOUS	O	25,000.00	1,818.44	8/4/2016	8/4/2016	8/31/2021	CHUN & DECOURCY, LLC	WC LEGAL SERVICES & REPRESENTATION		N	C
JUD 601	A	99.77	M	5,986.20	2,194.94	11/1/2016	11/1/2016	10/31/2021	RICOH USA, INC.	60 MONTH COPIER LEASE CJC WEST HAWAII		N	E
JUD 601	A	202.62	M	12,157.20	5,064.50	2/1/2017	2/1/2017	1/31/2022	XEROX CORPORATION	60 MONTH LEASE XEROX W7855PT ITCD		N	E
JUD 601	A	172.39	M	10,343.40	4,310.50	2/1/2017	2/1/2017	1/31/2022	XEROX CORPORATION	60 MONTH LEASE XEROX W7845PT COPIER REC		N	E

Judiciary
Active Contracts as of December 1, 2019

Prog ID	MOF	Amount	Frequency (M/A/O)	Max Value	Outstanding Balance	Date Executed	From	To	Entity	Contract Description	Explanation of How Contract is Monitored*	POS Y/N	Category E/L/P/C/G/S/*
JUD 601	B	3,736.42	A	3,736.42	0.00	3/10/2017	3/10/2019	3/10/2020	SHI INTERNATIONAL CORP	JIMS RENEWAL FOR TENABLE NETWORK SECURIT		N	S
JUD 601	A	VARIOUS	O	25,000.00	2,532.55	3/1/2017	3/31/2017	3/31/2020	LEONG KUNIHIRO BENTON & BROOKE	WC LEGAL SERVICES		N	C
JUD 601	A	202.62	M	12,157.20	5,470.50	3/28/2017	3/28/2017	3/27/2022	XEROX CORPORATION	60 MONTH COPIER LEASE FSD PAYROLL/ACCTG		N	E
JUD 601	A	VARIOUS	O	25,000.00	14,362.64	4/5/2017	4/5/2017	5/31/2022	LEONG KUNIHIRO LEZY & BENTON	WC LERGAL SERVICES & REPRESENTATION		N	C
JUD 601	A	10,088.82	A	10,088.82	10,088.82	6/1/2017	7/1/2019	6/30/2020	DAVID CORPORATION	SW SUPPORT/MAINT OF NAVRISK VISION-COMP		N	S
JUD 601	A	VARIOUS	O	25,000.00	22,218.67	3/1/2017	6/6/2017	5/31/2022	LEONG KUNIHIRO BENTON & BROOKE	WC LEGAL SERVICES & REPRESENTATION		N	C
JUD 601	A	VARIOUS	O	25,000.00	25,000.00	8/4/2016	6/22/2017	3/31/2022	CHUN & DECOURCY, LLC	WC LERGAL SERVICES & REPRESENTATION		N	C
JUD 601	A	442.35	M	26,541.00	13,712.90	8/1/2017	8/1/2017	7/31/2022	XEROX CORPORATION	60-MONTH XEROX WC-C70 COLOR PRINTER OEAC		N	E
JUD 601	A	120.00	M	1,440.00	960.00	7/1/2019	7/1/2019	6/30/2020	NURSERY ASSOCIATES, LTD.	PLANT RENTAL AND MAINTENANCE FOR SC		N	S
JUD 601	A	787.65	M	47,259.00	28,355.40	12/1/2017	12/1/2017	11/30/2022	XEROX CORPORATION	LEASE OF D110CP COPIER SN: BGO-973417 - BGT		N	E
JUD 601	A	147.04	M	8,822.40	5,000.50	11/1/2017	11/1/2017	10/30/2022	XEROX CORPORATION	60-MONTH COPIER LEASE BUDGET OFC MODEL C		N	E
JUD 601	A	355.10	M	21,306.09	12,428.50	12/1/2017	12/1/2017	11/30/2022	XEROX CORPORATION	60-MONTH COPIER LEASE BUDGET OFC MODEL X		N	E
JUD 601	A	130.72	M	7,583.00	6,275.68	1/1/2018	1/1/2018	12/31/2023	XEROX CORPORATION	COPIER LEASE 60-MONTH CJC MAUI		N	E
JUD 601	A	VARIOUS	O	25,000.00	24,825.08	4/5/2017	12/13/2017	10/31/2022	LEONG KUNIHIRO LEZY & BENTON	WC LERGAL SERVICES & REPRESENTATION		N	C
JUD 601	A	224.46	M	13,467.60	8,079.50	1/1/2018	1/1/2018	12/31/2022	XEROX CORPORATION	60-MONTH COPIER LEASE-FSD ACCTG COPIER R		N	E
JUD 601	A	215.60	M	12,936.00	7,761.50	1/1/2018	1/1/2018	12/31/2022	XEROX CORPORATION	60-MONTH COPIER LEASE-FSD CONTRACTS & PU		N	E
JUD 601	A	VARIOUS	O	48,909.55	0.00	5/31/2018	5/31/2019	6/30/2020	SKILLSOFT CORPORATION	LEARNING MANAGEMENT SYSTEM SOFTWARE		N	S
JUD 601	B	VARIOUS	O	1,657.44	1,079.94	5/15/2018	5/15/2019	5/14/2023	IBM CORPORATION	5-YR HW MAINTENANCE CISCO MDS 9148 FABRI		N	S
JUD 601	A	463.22	O	9,264.40	6,944.18	7/30/2018	7/30/2018	7/29/2023	PITNEY BOWES GLOBAL FINANCIAL	60-MONTH LEASE MAIL MACHINE SCALE AD OFF		N	L
JUD 601	A	22.99	A	3,888.45	551.76	9/1/2018	9/1/2018	8/30/2021	XEROX CORPORATION	AUTOSTORE SOFTWARE FOR XEROX COLOR C70		N	E
JUD 601	A	VARIOUS	O	180,000.00	43,869.13	7/1/2018	7/1/2018	6/30/2020	AKAMINE, OYADOMARI & KOSAKI,	PROVIDE FINANCIAL & COMPLIANCE AUDIT		N	S
JUD 601	A	VARIOUS	O	2,250.00	910.20	7/1/2019	7/1/2019	6/30/2020	GERARD, DIANNE, PH. D.	FY20 CJC CONSULTANT CONTRACT		N	S
JUD 601	A	VARIOUS	M	156,932.24	115,550.58	7/1/2018	7/1/2019	6/30/2023	HAWAIIAN TELCOM	HAWAIIAN TELCOM ISDN PRI SERVICES		N	S
JUD 601	A	305.91	O-Qtr	6,118.20	3,366.00	9/1/2018	9/1/2018	9/29/2023	PITNEY BOWES	60-MONTH LEASE MAILING MACHINE		N	L
JUD 601	A	VARIOUS	O	3,000.00	675.00	7/1/2018	7/1/2019	6/30/2020	WORKLIFE HAWAII	EMPLOYEE ASSISTANCE SERVICES		N	S
JUD 601	A	112.90	M	6,774.11	4,967.71	9/1/2018	9/1/2018	8/30/2023	XEROX CORPORATION	60-MONTH COPIER LEASE VERSALINK C505		N	E
JUD 601	B	4,771.31	A	14,313.92	4,771.31	7/20/2018	7/20/2018	7/19/2021	PACXA	HW MAINT TWO ORACLE X5-2 MODEL		N	S
JUD 601	A	VARIOUS	O	43,561.24	0.00	8/1/2018	8/1/2018	7/31/2021	Connecting the Dots LLC	RMO DOCUMENT SCANNER W/3-YR WARRANTY		N	E
JUD 601	B	223.14	A	425.02	0.00	8/1/2018	8/1/2019	7/31/2020	LENOVO (UNITED STATES) INC.	H/W MAINTENANCE-IBM X3530 BACKUP SERVER		N	S
JUD 601	A	245.95	M	14,757.00	11,067.75	10/1/2018	10/1/2018	9/30/2023	XEROX CORPORATION	60-MONTH COPIER LEASE JSC (C8055H)		N	E
JUD 601	A	169.96	M	10,200.00	7,650.24	10/1/2018	10/1/2018	9/30/2023	XEROX CORPORATION	60-MONTH COPIER LEASE CCR OFC C8045H		N	E
JUD 601	A	253.90	M	15,234.00	11,426.50	10/1/2018	10/1/2018	9/30/2023	XEROX CORPORATION	60-MONTH COPIER LEASE HR (C8055H)		N	E
JUD 601	A	191.97	M	11,518.20	9,231.93	10/1/2018	10/1/2018	9/30/2023	XEROX CORPORATION	60-MONTH COPIER LEASE C8045 COM JUD COND		N	E
JUD 601	A	537.64	M	32,258.40	30,647.00	1/1/2019	1/1/2019	12/31/2024	XEROX CORPORATION	60-MONTH COPIER LEASE C95CP HR DEPT		N	E
JUD 601	A	VARIOUS	M	40,500.00	27,697.00	1/1/2019	1/1/2019	6/30/2020	HAWAIIAN TELCOM	FY19-FY20 HAWN TELCOM LD SERVICES		N	S
JUD 601	A	16,230.36	A	16,230.36	0.00	12/10/2018	12/10/2018	12/10/2019	INSIGHT PUBLIC SECTOR, INC.	JIRA SOFTWARE MAINTENANCE		N	S
JUD 601	A	104.71	A	104.71	0.00	12/12/2018	12/12/2018	12/11/2019	TIME CLOCKS HAWAII INC.	TIME STAMP MAINTENANCE - ADLRO		N	S
JUD 601	B	96.86	A	96.86	0.00	1/22/2019	1/22/2019	1/22/2019	INSIGHT PUBLIC SECTOR, INC.	SW MAINTENANCE RENEWAL SURVEY AND VOTE		N	S
JUD 601	A	1,104.71	A	1,104.71	0.00	12/21/2018	12/21/2018	12/21/2019	INSIGHT PUBLIC SECTOR, INC.	RED HAT ENTERPRISE LINUX SVR SBSRPTN		N	S
JUD 601	B	VARIOUS	O	117,656.40	117,656.40	1/8/2019	1/8/2019	1/7/2024	HAWAIIAN TELCOM	ENHANCED IP DATA 4 EXISTING SITE UPGRADE		N	S
JUD 601	B	VARIOUS	O	29,260.80	29,260.80	1/8/2019	1/8/2019	1/7/2024	HAWAIIAN TELCOM	MPLS WAN KEAHOHU COURTHOUSE		N	S
JUD 601	A	57,887.42	A	57,887.41	0.00	2/1/2019	2/1/2019	1/31/2020	INSIGHT PUBLIC SECTOR, INC.	MAINT & SUBSCRIPTION FOR LANDESK MGMT		N	S
JUD 601	B	2,196.79	A	2,196.79	0.00	2/14/2019	2/14/2019	2/13/2020	PACXA	H/W MAINTENANCE FOR ORACLESUN STORAGETEK		N	S
JUD 601	A	38,091.92	A	38,091.92	0.00	3/1/2019	3/1/2019	2/29/2020	CARASOFT TECHNOLOGY CORP.	SW CLOUD MAINTENANCE JAMA, 35 LICENSES		N	S
JUD 601	B	2,881.23	A	2,881.23	0.00	4/30/2019	4/30/2019	4/30/2020	SHI INTERNATIONAL CORP	S/W MAINTENANCE TOAD 7 LICENSES		N	S
JUD 601	B	10,314.13	A	10,314.13	0.00	5/2/2019	5/2/2019	5/2/2020	INSIGHT PUBLIC SECTOR, INC.	SW LICENSE RENEWAL CONFLUENCE 500-USERS		N	S
JUD 601	A	15,256.54	A	15,256.54	0.00	3/30/2019	3/30/2019	3/29/2020	INSIGHT PUBLIC SECTOR, INC.	TRENDMICRO ENT SECURITY (OFFICESCAN) SW		N	S
JUD 601	B	2,073.30	A	2,073.30	0.00	5/31/2019	5/31/2019	5/30/2020	INSIGHT PUBLIC SECTOR, INC.	HW JIMS MAINTENANCE FOR IVR SERVERS		N	S
JUD 601	B	VARIOUS	O	27,785.40	27,785.40	3/1/2019	3/1/2019	2/29/2024	HAWAIIAN TELCOM	HWNTL MPLS WAN UPGRADE WAIMEA DC		N	S
JUD 601	A	149.34	M	8,960.40	8,266.59	6/1/2019	11/1/2018	10/31/2023	TOSHIBA BUSINESS SOLUTION	FY19 COPIER LEASE-CJC HILO		N	E
JUD 601	A	9,854.35	A	9,430.00	0.00	4/5/2019	4/5/2019	4/4/2020	NEXTSCAN	HW MAINT RENEWAL NEXTSCAN 4/5/19-4/4/20		N	S
JUD 601	A	206,319.65	A	618,958.95	412,639.30	6/1/2019	6/1/2019	5/31/2022	PACXA	3-YEAR AGREEMENT ORACLE DBASE LICENSING		N	S
JUD 601	A	49,422.44	A	49,522.70	100.26	4/24/2019	4/24/2019	4/23/2020	MICRO FOCUS (US), INC.	ACUCOBOL GT DEV SYS FOR IBM PSERIES UPGR		N	S
JUD 601	A	VARIOUS	O	15,000.00	15,000.00	6/1/2019	6/1/2019	6/30/2020	OFFICE OF LANGUAGE ACCESS (OLA)	MOA FY20 BASIC ORIENTATION WORKSHOP		N	S
JUD 601	A	VARIOUS	O	132,424.32	114,468.48	5/1/2019	5/1/2019	3/31/2024	WAGNER, JOHN	CJC EAST HAWAII LEASE RENTAL		N	L
JUD 601	A	VARIOUS	M	74,925.00	49,848.75	7/5/2019	7/5/2019	6/30/2022	EWORLD ENTERPRISE SOLUTIONS,	TIVOLI & LOTUS NOTES SUPPORT (RFP)		N	S
JUD 601	A	33,333.00	M	400,000.00	233,335.00	7/1/2019	7/1/2019	6/30/2020	MEDIATION CENTERS OF HAWAII,	ADMIN - MEDIATION AND RELATED DISPUTE RE		Y	C
JUD 601	A	3,275.00	A	3,275.00	3,275.00	7/1/2019	7/1/2019	6/30/2020	AXIELL ALM CANADA INC.	FY20 SOFTWARE SUBSCRIPTION MAINTENANCE		N	S
JUD 601	A	VARIOUS	O	1,662.50	1,662.50	7/1/2019	7/1/2019	6/30/2020	WOODS, MAIKA	FY20 CARPET CLEANING AND STRIPPING CJC E		N	S

Judiciary
Active Contracts as of December 1, 2019

Prog ID	MOF	Amount	Frequency (M/A/O)	Max Value	Outstanding Balance	Date Executed	From	To	Entity	Contract Description	Explanation of How Contract is Monitored*	POS Y/N	Category E/L/P/C/G/S/*
JUD 601	B	2,467.43	A	2,467.43	0.00	7/7/2019	7/7/2019	6/7/2020	PACXA	HW MAINTENANCE TWO ORACLESUN X4-2		N	S
JUD 601	A	VARIOUS	O	24,764.39	22,159.53	7/1/2019	7/1/2019	6/30/2020	FILEMINDERS OF HAWAII, LLC	RMO SHREDDING SERVICES		N	S
JUD 601	A	4,554.97	A	4,554.97	0.00	7/1/2019	7/1/2019	6/30/2020	A3 COMMUNICATION, INC.	FY20 METROPOLIS OFFICEWATCH SL MAINT		N	S
JUD 601	A	16,802.09	A	16,802.09	0.00	7/1/2019	7/1/2019	6/30/2020	WORLD WIDE TECHNOLOGY, INC	FY20 SINGLEWIRE INFORMCAST MAINTENANCE		N	S
JUD 601	A	VARIOUS	O	10,000.00	10,000.00	7/1/2019	7/1/2019	6/30/2020	CATHOLIC CHARITIES - CSATP	SEXUALLY REACTIVE YOUTH		Y	S
JUD 601	B	39,203.25	O - QTR	156,813.00	78,406.50	7/1/2019	7/1/2019	6/30/2020	DOMESTIC VIOLENCE ACTION	ILAF FY20 RFA J19267		N	L
JUD 601	B	21,893.25	O - QTR	87,573.00	43,786.50	7/1/2019	7/1/2019	6/30/2020	HAWAII DISABILITY RIGHTS	ILAF FY20 RFA J19267		N	L
JUD 601	B	7,368.50	O - QTR	29,474.00	14,737.00	7/1/2019	7/1/2019	6/30/2020	HAWAII APPLESEED CENTER FOR	ILAF FY20 RFA J19267		N	L
JUD 601	B	136,751.00	O - QTR	547,004.00	273,502.00	7/1/2019	7/1/2019	6/30/2020	LEGAL AID SOCIETY OF HAWAII	ILAF FY20 RFA J19267		N	L
JUD 601	B	4,897.00	O - QTR	19,588.00	9,794.00	7/1/2019	7/1/2019	6/30/2020	MEDIATION CENTER OF THE	ILAF FY20 RFA J19267-Mediation Center of the Pacific, Inc.		N	L
JUD 601	B	17,532.50	O - QTR	70,130.00	35,065.00	7/1/2019	7/1/2019	6/30/2020	NATIVE HAWAIIAN LEGAL	ILAF FY20 RFA J19267-Native Hawaiian Legal Corp		N	L
JUD 601	B	6,692.50	O - QTR	26,770.00	13,385.00	7/1/2019	7/1/2019	6/30/2020	UNIVERSITY OF HAWAII	ILAF FY20 RFA J19267-Elder Law Program		N	L
JUD 601	B	6,741.50	O - QTR	26,966.00	13,483.00	7/1/2019	7/1/2019	6/30/2020	UNIVERSITY OF HAWAII	ILAF FY20 RFA J19267- Medical/Legal Partnership Hawaii		N	L
JUD 601	B	8,920.50	O - QTR	35,682.00	17,841.00	7/1/2019	7/1/2019	6/30/2020	VOLUNTEER LEGAL SERVICES	ILAF FY20 RFA J19267		N	L
JUD 601	B	15,575.25	O - QTR	62,301.00	31,150.50	7/1/2019	7/1/2019	6/30/2020	HAWAII JUSTICE FOUNDATION	ILAF FY20 ADMINISTRATOR (RFA J19267)		N	L
JUD 601	B	VARIOUS	M	48,000.00	33,920.00	7/1/2019	7/1/2019	6/30/2020	OHANASOFT LLC	JIMS SW ORACLE GL TECHNICAL SVCS		N	S
JUD 601	A	432.75	M	5,193.00	3,894.75	7/1/2019	7/1/2019	6/30/2020	ARC OF HILO, THE	FY20 CJC East Hawaii Janitorial Svcs		N	S
JUD 601	A	728.80	M	8,745.60	5,830.40	7/1/2019	7/1/2019	6/30/2020	JANI-KING HAWAII	FY20 JANITORIAL SVCS FOR CJC OAHU		N	S
JUD 601	A	VARIOUS	O	15,000.00	13,087.50	7/1/2019	7/1/2019	6/30/2020	CATHOLIC CHARITIES - CSATP	CJC PHYSICAL ABUSE VICTIM ADVOCACY/CRISI		Y	S
JUD 601	A	17,566.01	A	17,566.01	0.00	7/1/2019	7/1/2019	6/30/2020	TRANSOURCE SERVICES CORP	FY20-VIAMI NETWORK MONITORING TOOL		N	S
JUD 601	A	4,041.88	A	4,041.88	0.00	6/29/2019	6/29/2019	6/30/2020	INSIGHT PUBLIC SECTOR, INC.	FY20-SOLAR WINDS NETWORK PERFOR MONITOR		N	S
JUD 601	A	1,431.62	A	1,431.62	0.00	7/1/2019	7/1/2019	6/30/2020	WORLD WIDE TECHNOLOGY, INC	FY20 CISCO VIDEO SURVEILLANCE SYSTEM		N	S
JUD 601	A	VARIOUS	O	5,204.19	5,204.19	11/9/2019	11/9/2019	6/30/2020	INSIGHT PUBLIC SECTOR, INC.	FY20 SPLUNK ENTERPRISE LOGGING MONITOR		N	S
JUD 601	A	VARIOUS	O	10,000.00	10,000.00	7/1/2019	7/1/2019	6/30/2020	WESLEY, SUSANNAH COMMUNITY	CJC - INTERV AND VICTIM ADV-HUMAN TRAFFI		Y	S
JUD 601	B	VARIOUS	M	32,460.72	21,586.38	7/1/2019	7/1/2019	6/30/2020	CENTURY COMPUTERS, INC.	FY20-KOFAX/FILENET SW MAINT JIMS		N	S
JUD 601	A	VARIOUS	M	8,115.18	7,060.21	7/1/2019	7/1/2019	6/30/2020	CENTURY COMPUTERS, INC.	FY20-KOFAX/FILENET SW MAINT RMO/JUSTIS		N	S
JUD 601	A	60,271.22	A	60,792.54	521.32	7/1/2019	7/1/2019	6/30/2020	INSIGHT PUBLIC SECTOR, INC.	MICRO FOCUS ENTERPRISE SERVER LICENSES		N	S
JUD 601	A	VARIOUS	M	6,562.08	4,692.97	7/1/2019	7/1/2019	6/30/2020	ALII CLEANING SERVICE	FY20 CJC KAUAI JANITORIAL SERVICES		N	S
JUD 601	A	VARIOUS	O - QTR	15,000.00	15,000.00	7/1/2019	7/1/2019	6/30/2020	NATIONAL CHILDREN'S ADVOC	FY20 CJC CONSULTANT CONTRACT CHILD FOREN		N	S
JUD 601	A	28,192.32	A	28,192.32	0.00	8/1/2019	8/1/2019	7/31/2020	INSIGHT PUBLIC SECTOR, INC.	IBM PASSPORT ADVANTAGE DB2 DOMINO SERVER		N	S
JUD 601	A	30,890.04	A	30,890.04	0.00	8/1/2019	8/1/2019	7/31/2020	INSIGHT PUBLIC SECTOR, INC.	FY20 IBM RATIONAL HIS FOR MULTIPLATFORMS		N	S
JUD 601	B	390,450.13	A	390,450.13	390,450.13	7/1/2019	7/1/2019	6/30/2020	WORLD WIDE TECHNOLOGY, INC	FY20-JIMS CISCO SMARTNET MAINTENANCE		N	S
JUD 601	A	13,444.27	A	13,444.27	0.00	7/1/2019	7/1/2019	6/30/2020	WORLD WIDE TECHNOLOGY, INC	FY20-ITDC CISCO SMARTNET MAINTENANCE		N	S
JUD 601	A	81,918.03	A	81,918.03	0.00	8/1/2019	8/1/2019	7/31/2020	INSIGHT PUBLIC SECTOR, INC.	RENEW SMARTCLOUDLOTUS EMAIL IBM PASSPORT		N	S
JUD 601	A	VARIOUS	M	15,000.00	10,573.87	7/1/2019	7/1/2019	6/30/2020	TMB Consulting Corp	FY20-CONSULTING SERVICES FOR CCR		N	S
JUD 601	N	VARIOUS	M	8,000.00	2,712.50	7/1/2019	7/1/2019	1/31/2020	KAWANO, JUDY R.	COORDINATOR SVCS-CJC MILITARY GRANT		N	S
JUD 601	A	VARIOUS	M	5,198.95	3,453.43	7/1/2019	7/1/2019	6/30/2020	PROFESSIONAL PROTECTIVE	SECURITY SERVICES CJC EAST HAWAII		N	S
JUD 601	A	VARIOUS	O	33,327.07	33,327.07	8/1/2019	8/1/2019	7/31/2020	PACXA	MS HYPERV ACTIVE DIRECTORY SYSTEM ADMIN		N	S
JUD 601	B	3,073.30	A	3,073.30	0.00	9/1/2019	9/1/2019	8/31/2020	INSIGHT PUBLIC SECTOR, INC.	SW MAINT AND SUPPORT RENEWAL ITEXT		N	S
JUD 601	A	VARIOUS	M	50,000.00	48,363.98	7/1/2019	7/1/2019	6/30/2020	LANGUAGE LINK	FY20 TELEPHONE INTERPRETING SERVICES		N	S
JUD 601	A	220.10	M	13,206.00	12,765.80	10/1/2019	10/1/2019	9/30/2024	XEROX CORPORATION	60-MONTH COPIER LEASE C8070H ADMIN DIR O		N	E
JUD 601	A	1,123.06	M	67,383.60	62,331.00	10/1/2019	10/1/2019	9/30/2024	XEROX CORPORATION	60-MONTH COPIER LEASE D136 GRAPHICS OFC		N	E
JUD 601	A	33,303.38	A	33,303.38	0.00	9/1/2019	9/1/2019	8/31/2020	CENTURY COMPUTERS, INC.	FY20-SW MAINTENANCE KOFAX		N	S
JUD 601	A	7,417.80	A	7,417.80	0.00	9/1/2019	9/1/2019	8/31/2020	WORD SYSTEMS, INC.	FY20 CJC REMOTE TECHNICAL SVC AGREEMENT		N	S
JUD 601	B	4,547.12	A	4,547.12	0.00	9/19/2019	9/19/2019	9/18/2020	INSIGHT PUBLIC SECTOR, INC.	FY20 SW MAINTENANCE VERITAS NETBACK		N	S
JUD 601	B	11,967.45	A	11,967.45	0.00	9/24/2019	9/24/2019	9/23/2020	SHI INTERNATIONAL CORP	FY20-SW MAINTENANCE UFTE 3 LICENSES		N	S
JUD 601	A	VARIOUS	O	5,000.00	5,000.00	9/1/2019	9/1/2019	6/30/2020	KANEMITSU, MELISSA	FY20 FORENSIC INTERVIEW SERVICES FOR CJC		N	S
JUD 601	A	243.63	M	14,617.80	13,523.50	9/23/2019	9/23/2019	9/22/2024	XEROX CORPORATION	60-MONTH LEASE XEROX V180 COLOR REPO GRA		N	E
JUD 601	B	VARIOUS	O	2,481.34	2,481.34	10/11/2019	10/11/2019	10/11/2020	SHI INTERNATIONAL CORP	SW ATLISSIAN SCROLL VERSIONS CONFLUENCE		N	S
JUD 601	A	19,294.63	A	19,294.63	0.00	11/16/2019	11/16/2019	11/15/2020	SHI INTERNATIONAL CORP	FY20 SW MAINTENANCE SAP CRYSTAL REPORTS		N	S
JUD 601	A	149.19	M	8,951.00	6,265.86	10/21/2019	10/21/2019	10/20/2024	XEROX CORPORATION	60-MONTH C8045H COPIER LEASE - STAFF ATTORNEY OFFICE		N	E
JUD 601	A	VARIOUS	O	50,160.00	41,800.00	9/1/2019	9/1/2019	8/31/2020	AVOLIN LLC	"REALTIME" ACTG SVCS P/R&OVERNITE PRCG		N	S
JUD 601	B	VARIOUS	O	6,792.19	6,792.19	9/24/2019	9/24/2019	9/23/2020	PACXA	JIMS - HW MAINTENANCE: ORACLESUN X3-2 MO		N	S
JUD 601	A	VARIOUS	O	53,140.29	53,140.29	8/1/2019	8/1/2019	7/31/2020	INSIGHT PUBLIC SECTOR, IN	SOFTWARE MAINTENANCE FOR IBM FILENET		N	S
JUD 601	B	VARIOUS	O	1,497.38	1,497.38	11/27/2019	11/27/2019	11/27/2020	INSIGHT PUBLIC SECTOR, INC.	S/W MAINTENANCE: GOEDIT FOR CONFLUENCE,		N	S
JUD 601	A	VARIOUS	O	24,500.00	23,975.83	8/27/2019	8/27/2019	8/26/2024	CHUN & DECOURCY, LLC	WC LEGAL SERVICES AND REPRESENTATION		N	C
JUD 601	A	87.75	M	5,265.00	5,265.00	12/1/2019	12/1/2019	11/30/2024	KONICA MINOLTA BUSINESS	CJC KAUAI - COPIER LEASE		N	E
JUD 601	A	VARIOUS	O	20,020.94	20,020.94	10/28/2019	10/28/2019	10/27/2020	SIRIUS COMPUTER SOLUTIONS, INC	IBM POWER 9 SYSTEM MIGRATION		N	S
JUD 601	A	73,226.77	O-SEMIANNL	146,453.53	73,226.33	1/1/1990	7/1/2019	6/30/2020	SOFTWARE AG USA, INC.	ADABAS SOFTWARE MAINTENANCE		N	S

Judiciary
Active Contracts as of December 1, 2019

Table 14

Prog ID	MOF	Amount	Frequency (M/A/O)	Max Value	Outstanding Balance	Date Executed	From	To	Entity	Contract Description	Explanation of How Contract is Monitored*	POS Y/N	Category E/L/P/C/G/S/*
JUD 601	A	46,619.23	A	139,857.69	0.00	1/31/1996	3/31/2017	3/30/2020	CA, INC.	ANN. LIC FEE AND MAINFRAME MAINTENANCE		N	S
JUD 601	B	VARIOUS	M	3,812,426.00	684,006.57	10/3/2012	7/1/2019	2/28/2020	CAPGEMINI AMERICA INC.	SOW 19 - EXECUTION PHASE OF CC/DC CIVIL PROJECT		N	S
JUD 601	A	3,200.00	A	21,000.00	9,600.00	3/9/2017	5/22/2017	5/22/2022	BYWATER SOLUTIONS	SUBSCRIPTION-INTEGRATED LIBRARY SYSTEM		N	S
JUD 601	A	389.53	A	389.53	0.00	6/28/2019	7/1/2019	6/30/2020	ELECTRONIC BUSINESS MACHINES	ANNUAL TYPEWRITER MAINTENANCE		N	S
JUD 601	B	228.04	M	13,682.40	11,428.06	11/2/2018	12/11/2018	12/10/2023	XEROX CORPORATION	COPIERS (2) LEASES FOR LAW LIBRARY		N	E
JUD 601	A	229.95	M	13,797.00	1,820.59	12/18/2014	3/15/2015	3/14/2020	XEROX CORPORATION	LAW LIBRARY - COPIER LEASE		N	E
*Contract monitoring is performed by the contract administrator of each contract at the program level. For POS contracts, the contract administrators at the programs monitor the contracts pursuant to HRS 103F.													
Note: Contracts in red are non-general fund.													

Capital Improvements Program (CIP) Requests

<u>Prog ID</u>	<u>Prog ID</u> <u>Priority</u>	<u>Dept- Wide Priority</u>	<u>Senate District</u>	<u>Rep. District</u>	<u>Project Title</u>	<u>MOF</u>	<u>FY20 \$\$\$</u>	<u>FY21 \$\$\$</u>
JUD 601	1		13	26	Ka'ahumanu Hale Fire Alarm Systems/ Elevator Upgrade [C]	C		\$ 17,550,000
JUD 601	2				Lump Sum CIP	C		\$ 3,000,000
JUD 601	3		5	8	Hoapili Hale Parking Structure Piping Renovations [D], [C]	C		\$ 2,800,000
JUD 601	4		8	15	Reroof and Repair Leaks/Damages - Kauai Courthouse [C]	C		\$ 2,650,000
JUD 601	5		13	26	Ka'ahumanu Hale Sheriff Station Renovation [D], [C]	C		\$ 1,700,000
								\$ 27,700,000

Judiciary
CIP Lapses

Table 16

<u>Prog ID</u>	<u>Act/Year of Appropriation</u>	<u>Project Title</u>	<u>MOF</u>	<u>Lapse Amount</u> <u>\$\$\$\$</u>	<u>Reason</u>
JUD 601	Act 26/18	Kona Judiciary Complex FF & E	C	\$ 1,000,000.00	Funds remaining after addressing FF & E requirements for the new Kona Judiciary Complex

Program ID Sub-Organizations

<u>Program ID</u>	<u>Sub-Org Code</u>	<u>Name</u>	<u>Objective</u>
None			

Judiciary
Organization Changes

Table 18

<u>Year of Change</u> FY20/FY21	<u>Description of Change</u>
FY20	Supreme Court, Office of the Chief Justice - Restructure the organization to create a new organizational unit designated as Criminal Justice Institute as set forth in House Bill No. 1552, C.D.1 (2019); create an exempt position as director of the institute, two (2) exempt assistant researchers and one (1) exempt clerical assistant
FY20	First Circuit, Administrative Services Division, Fiscal Management and Support Services Branch, Kapolei Section - Restructure the organization to create a full supervisory level over the Receivables/Revenues Unit; transfer position from the Accounting Unit to the Receivables/Revenues Unit to assume the supervisory duties.
FY20	Office of the Administrative Director, Information Technology and Systems Department - Restructure the organization to merge duplicate functions in the Information Technology and Communications Division and the Judiciary Information Management Systems (JIMS); create three (3) new divisions--Applications Division (custom built & Commercial Off-the Shelf applications), Infrastructure Division 1 (legacy IBM systems) and Infrastructure Division 2 (X86 server and desktop IT); and reassign staff in current branches and sections accordingly based on function.

Office of the Administrative Director of the Courts

Chief Justice
206E

**Administrative Director
of the Courts**
223E

Prvt Sec II SR-24
59259E
Sp. Asst. to Admin Dir. EM05
500562E 59404E
Clk IV SR-10
59113

Ofc of Staff Attorney
Chief Staff Atty/ICRD Dir
4712 ES-01 1)
Sr Staff Atty EM-05
58952
Atty SR-28
500408

**Commission on
Judicial Conduct**
Admin Asst II SR-21
22539 *

**Judicial Selection
Commission**
Admin Asst II SR-21
58945 *

* Reports to the Administrative Director of the Courts
for administrative purposes only.

**Deputy Administrative
Director of the Courts**
14563E

Prvt Sec I SR-22
59112E

EEO Ofcr SR-26
58961

Administration Fiscal Office
Ct Fiscal Ofcr II SR-26
57507
Accountant IV SR-22
57518
Acct Clk V SR-15
57236
Acct Clk IV SR-13
59222

**Judiciary Security & Emergency
Mgmt Office**
Special Asst for Jud Sec EM-05
24063
Program Specialist II SR-24
26622

1) Pos No 4712 Serves as Chief Staff Atty
and ICRD Director.
2) Title to be amended.

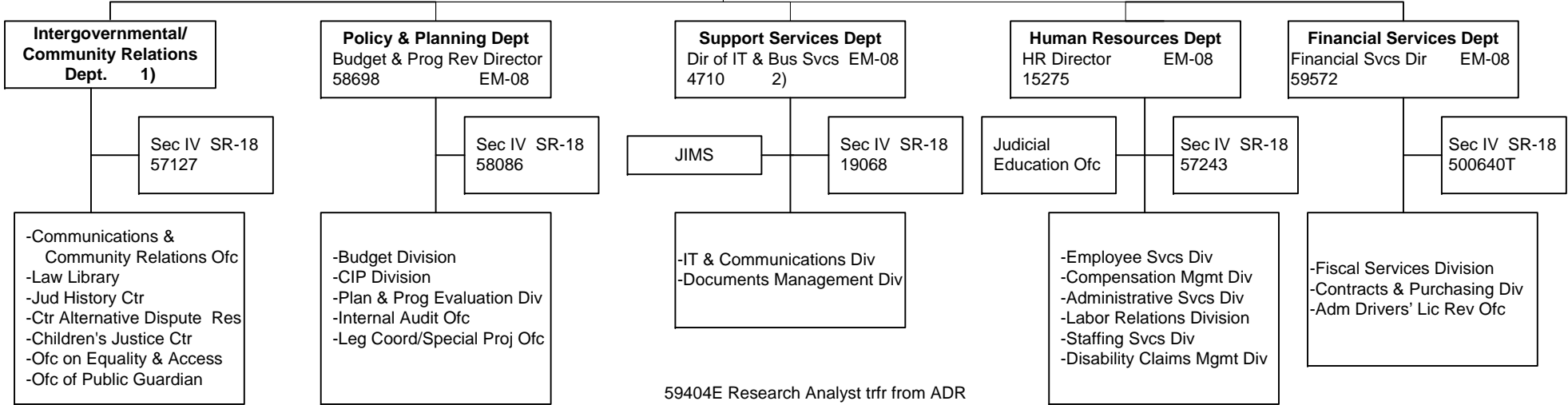

59404E Research Analyst trfr from ADR

Intergovernmental/Community Relations Dept

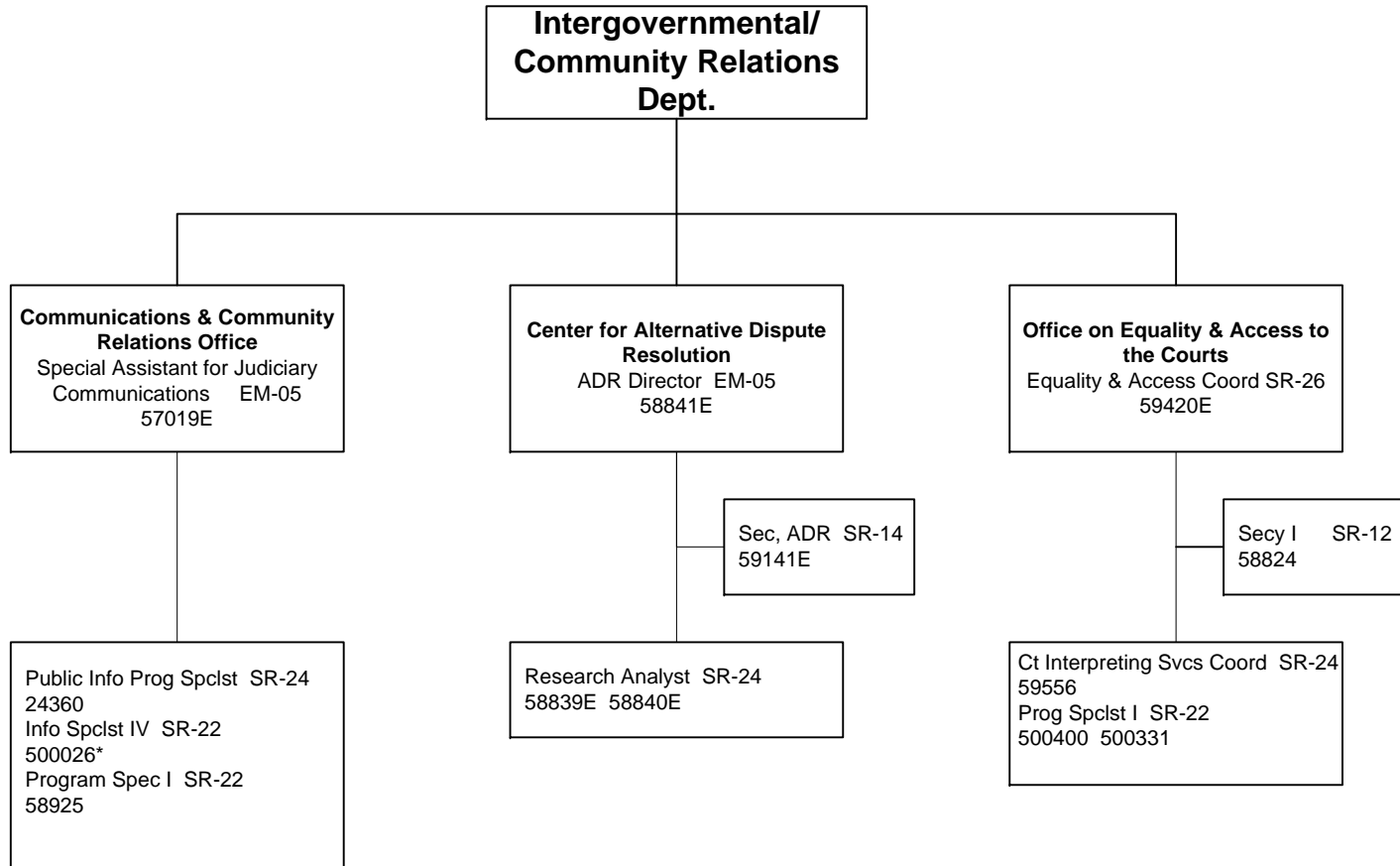

*Special Funded

500672T Info Spclt IV trfr to HR/ES
59404E Research Analyst trfr to AD

Updated October 2018

Intergovernmental/Community Relations Dept

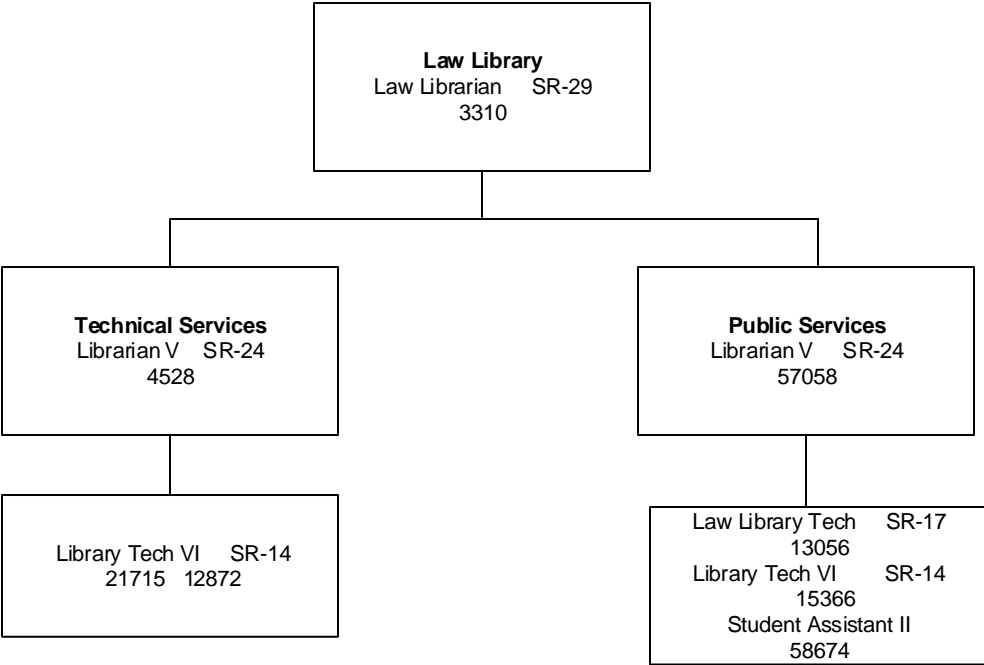

Intergovernmental/Community Relations Dept

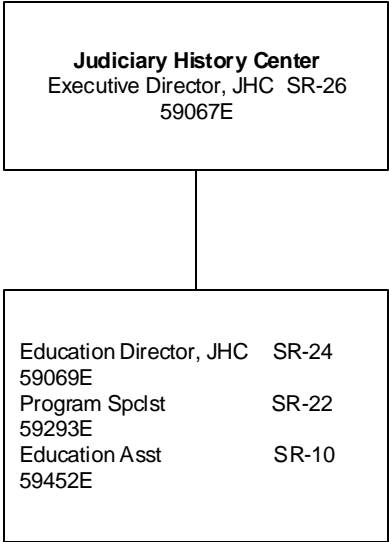

Intergovernmental/ Community Relations

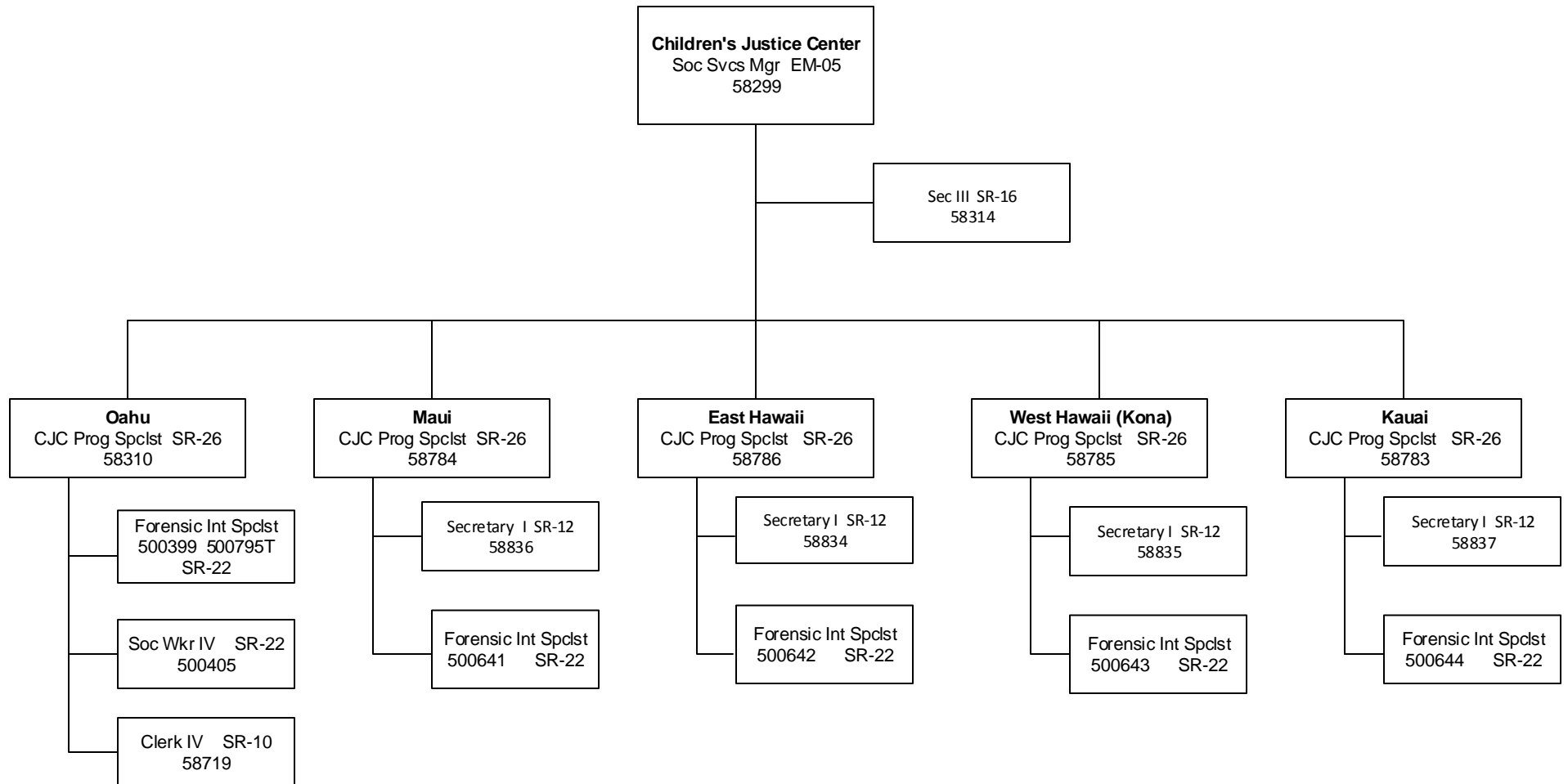

Intergovernmental/Community Relations

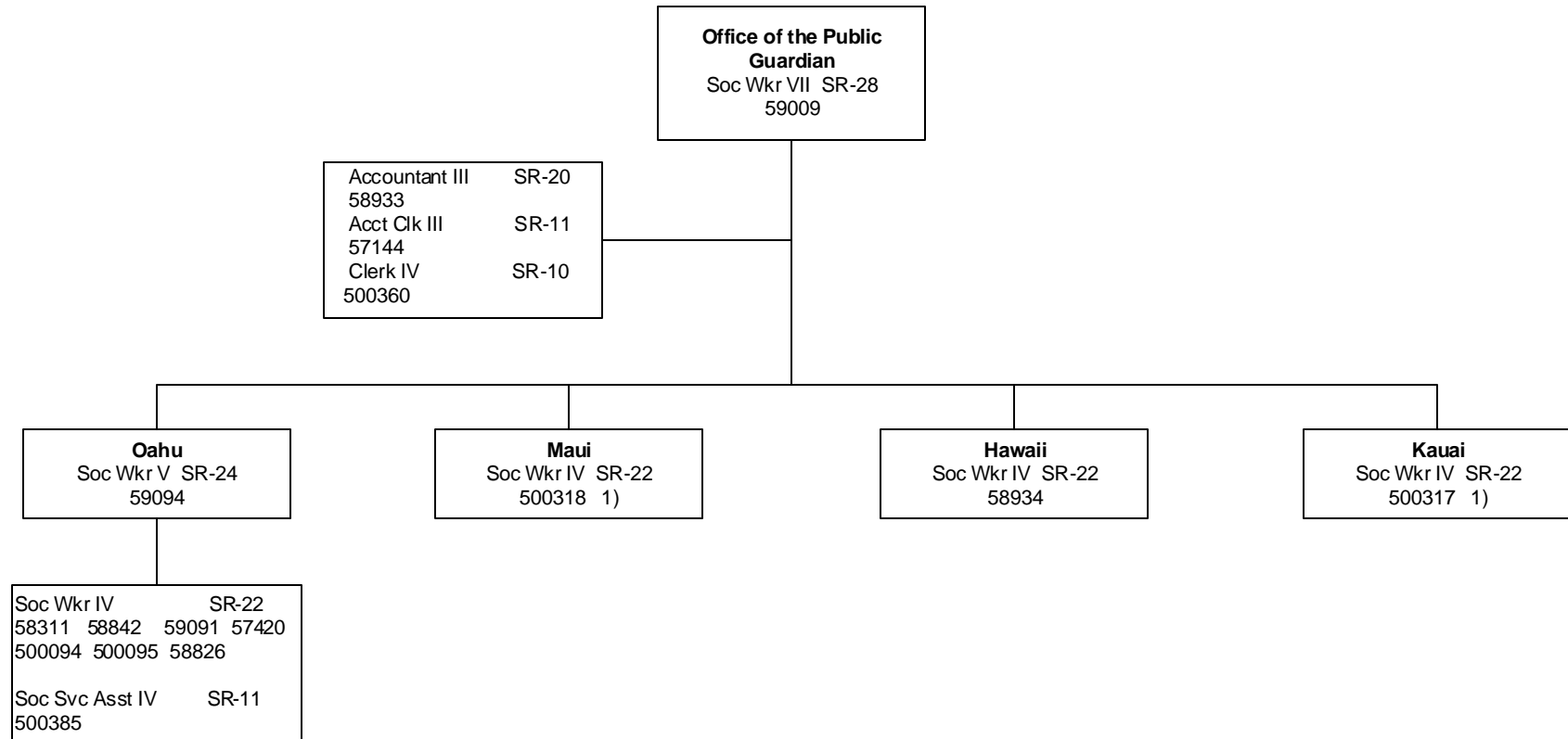

1) Position is .50 FTE

Policy & Planning Dept

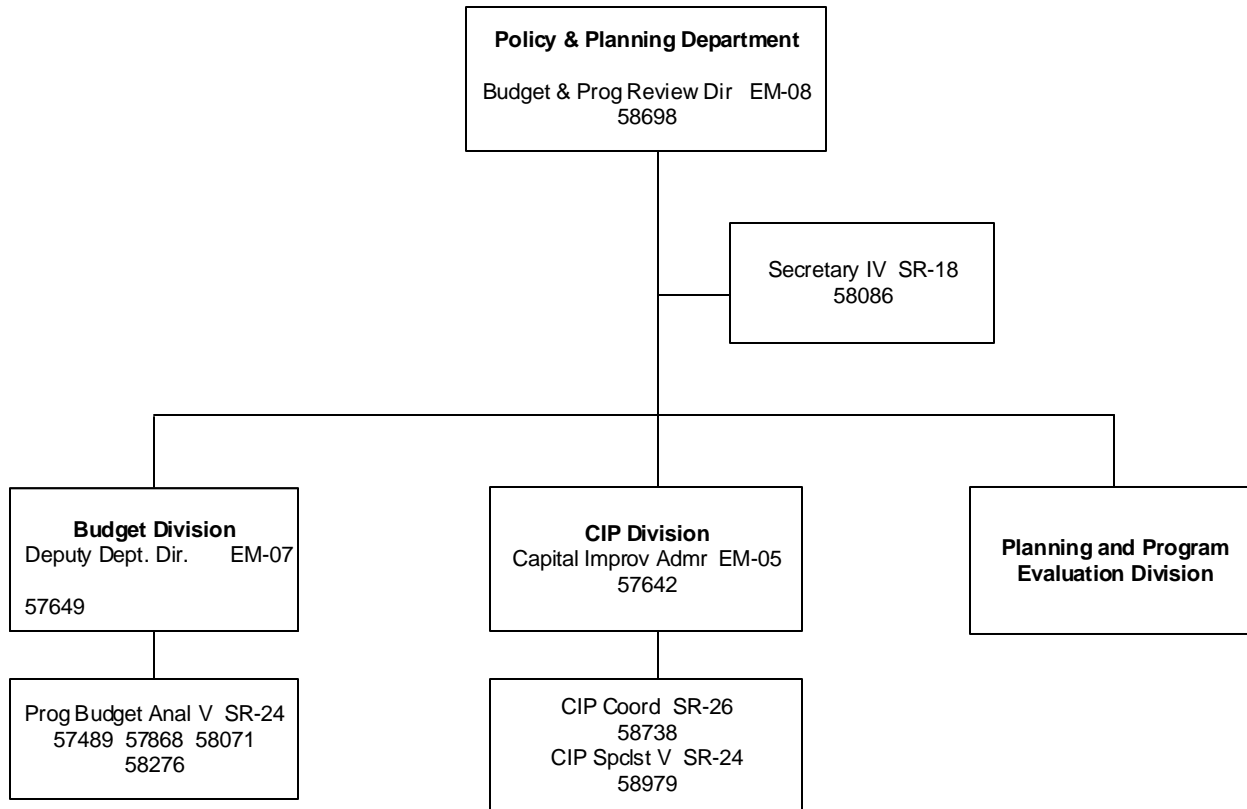

Policy & Planning

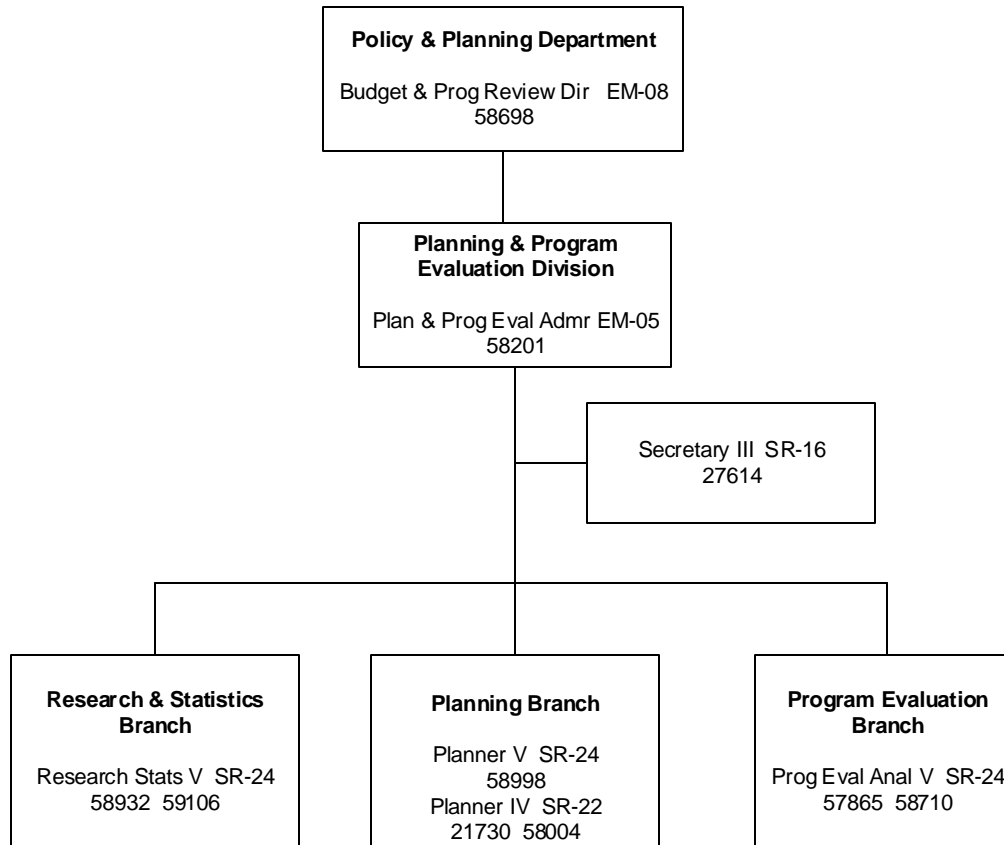

Policy & Planning Dept

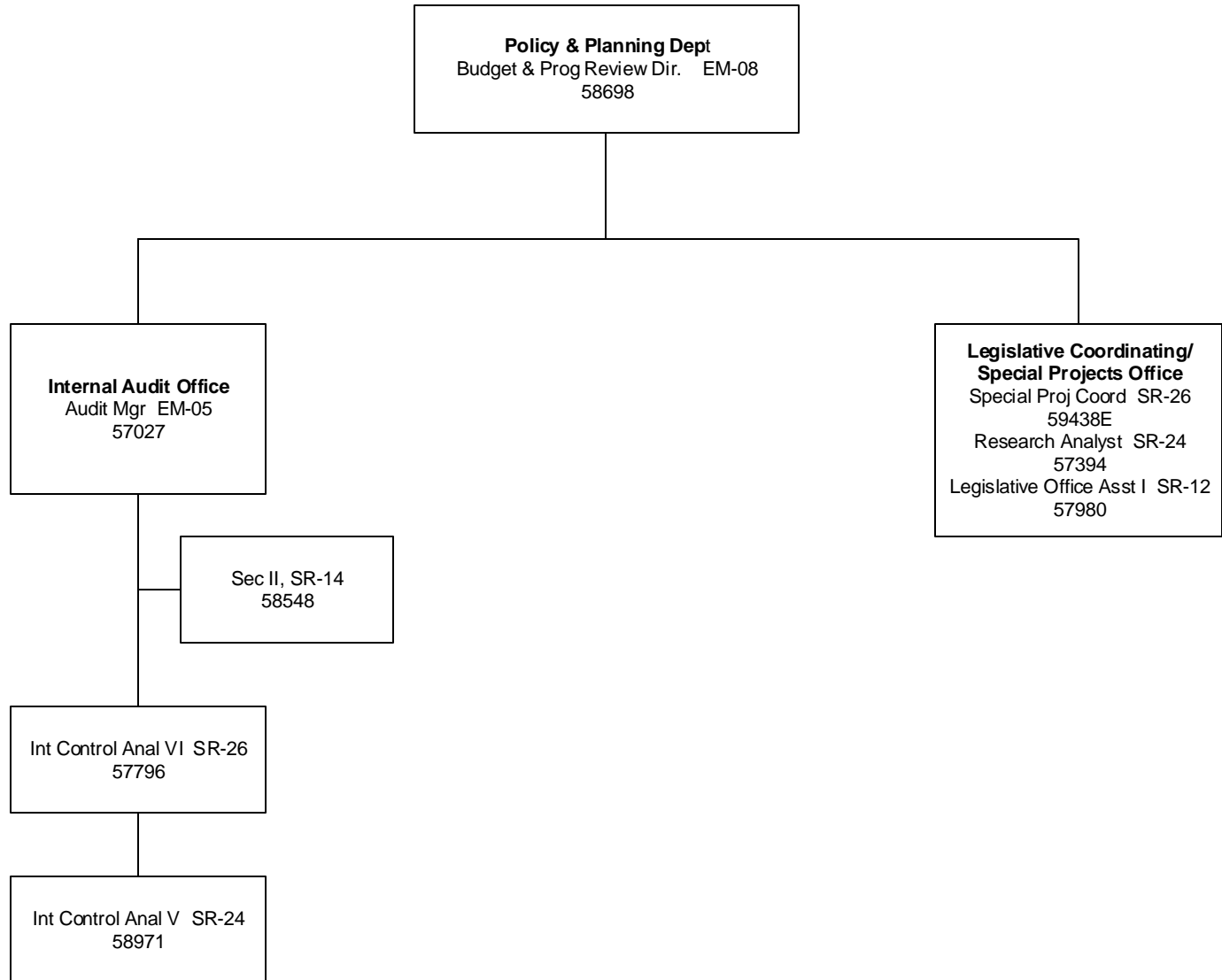

IT & Systems Department

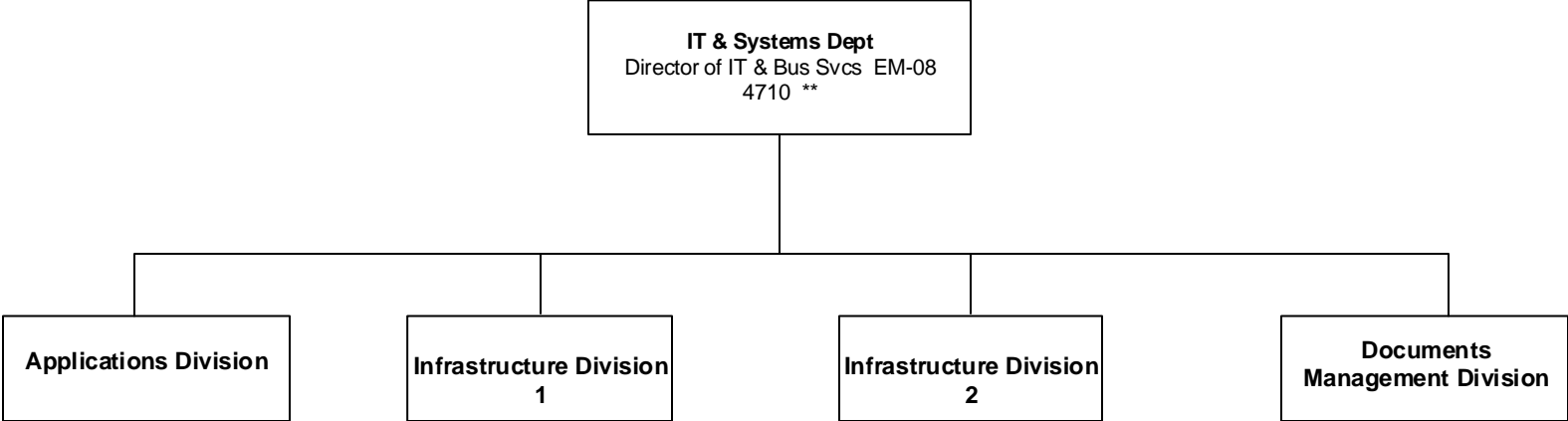

IT & Systems Department

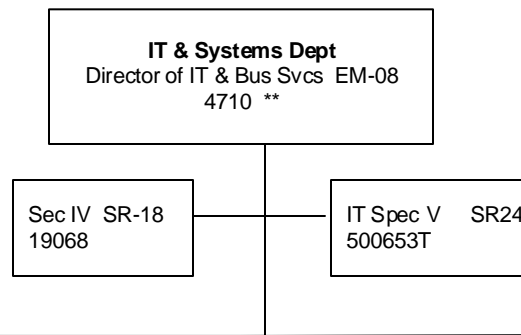

Continue on next page

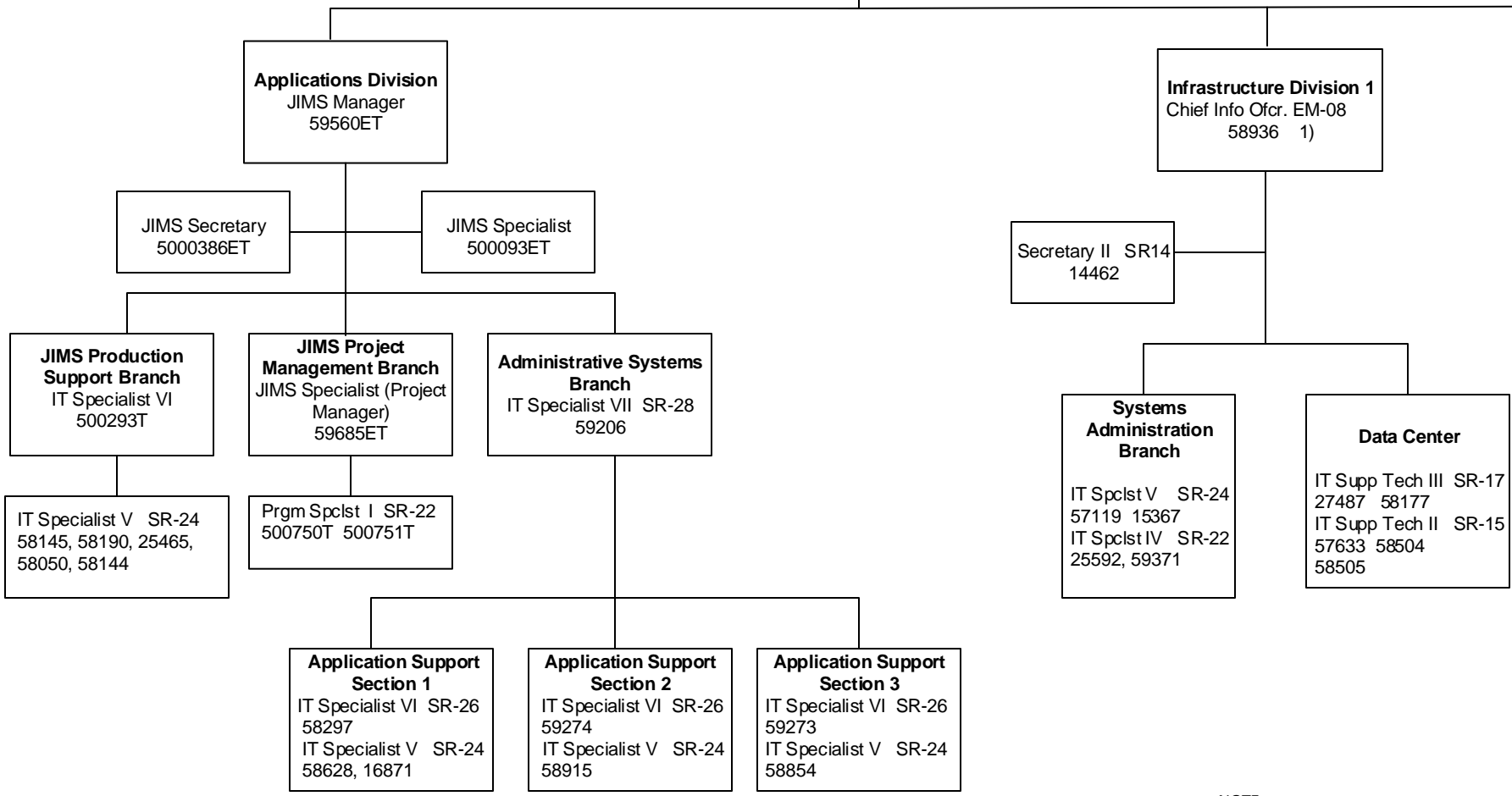

NOTE:
 ** Title to be amended
 1) Position to be reviewed

IT & Systems Department

Continued from previous page

Continue on next page

- NOTE:
 1) Vacant position to be reviewed and redescrbed
 2) Position to be reviewed
 3) Position to be reviewed and redescrbed

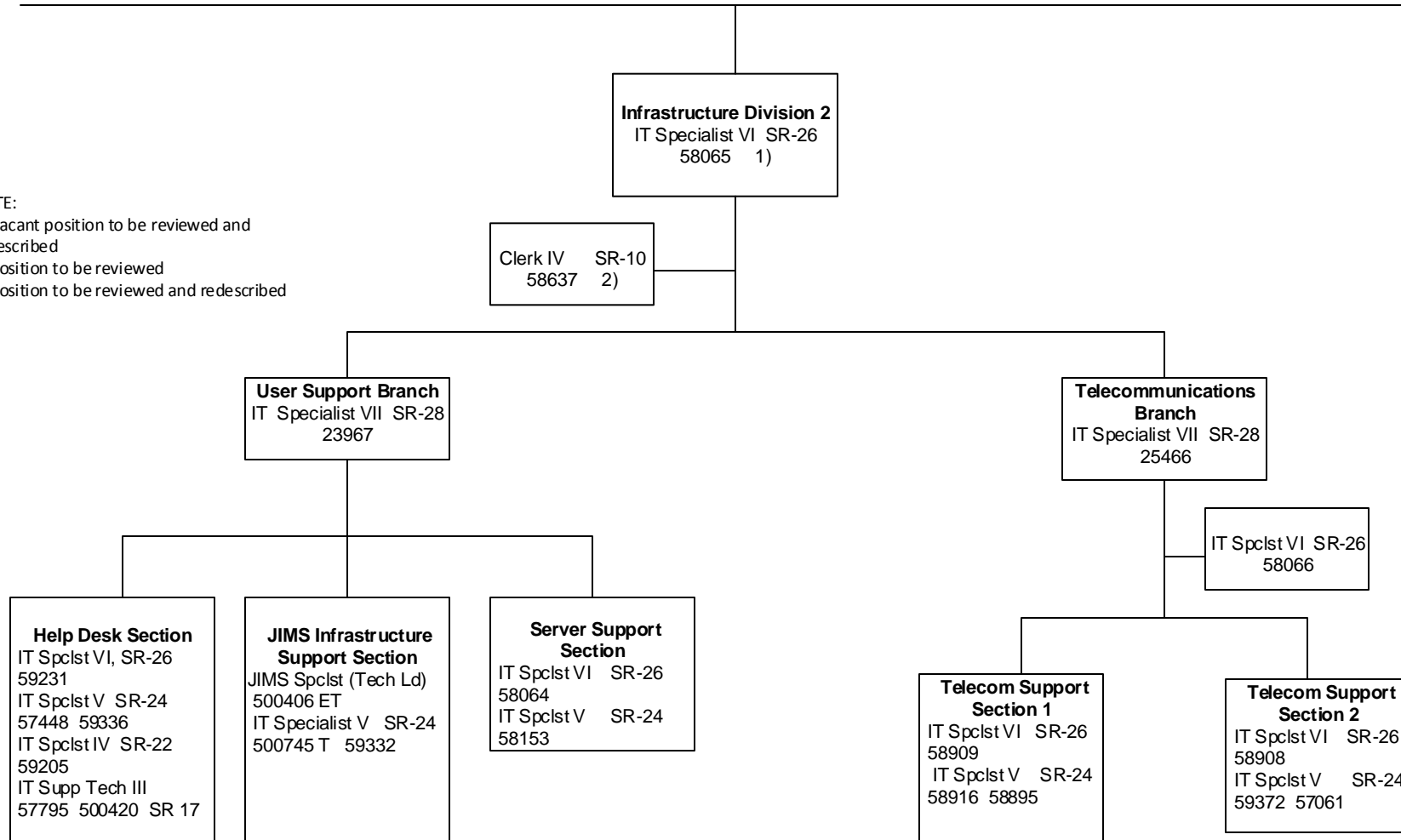

Updated

IT & Systems Department

Continued from previous page

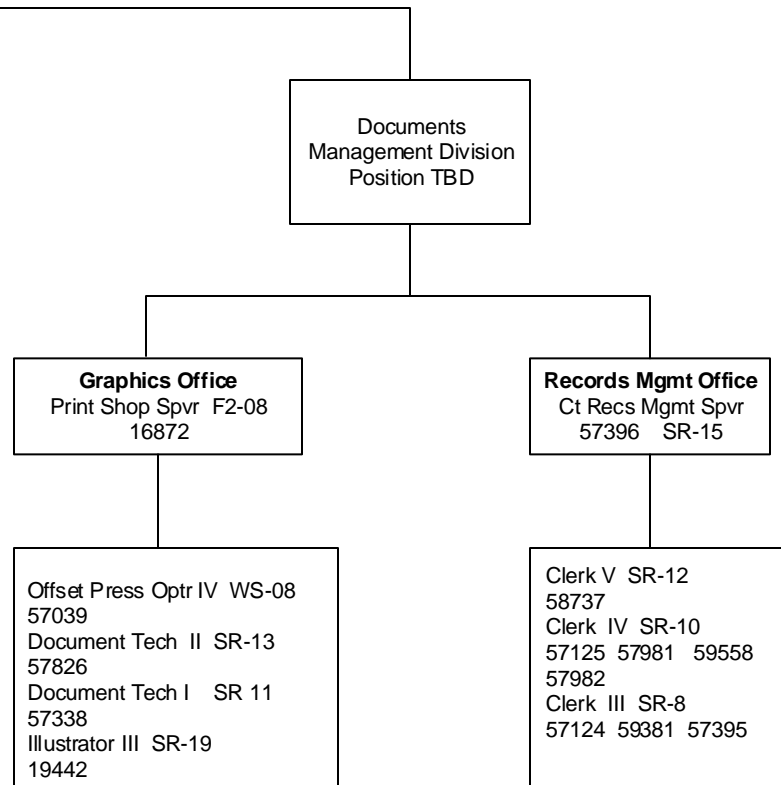

Position 500464 Clerk III Abolished

Updated January 2020

Human Resources Dept

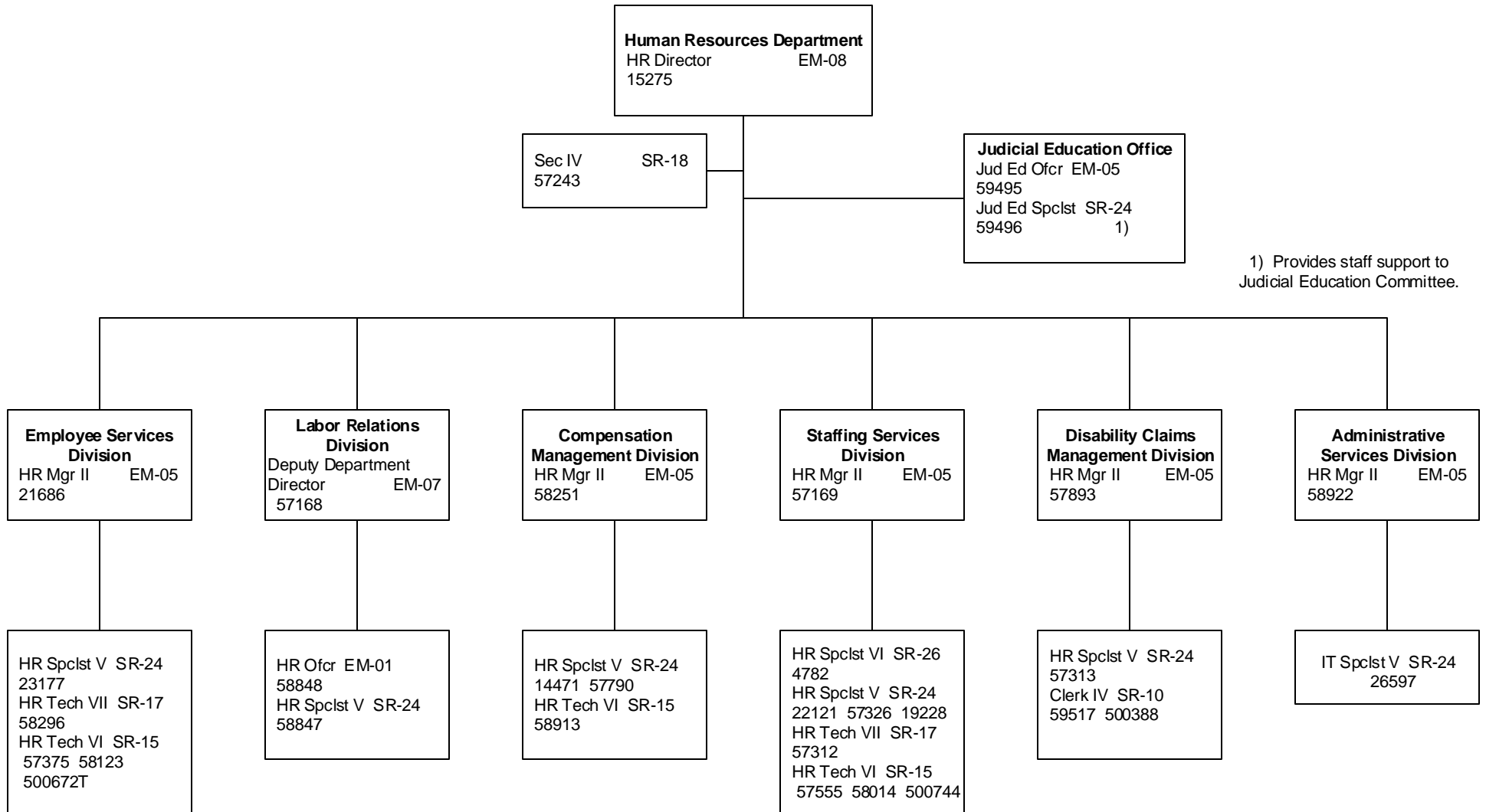

Financial Services Dept

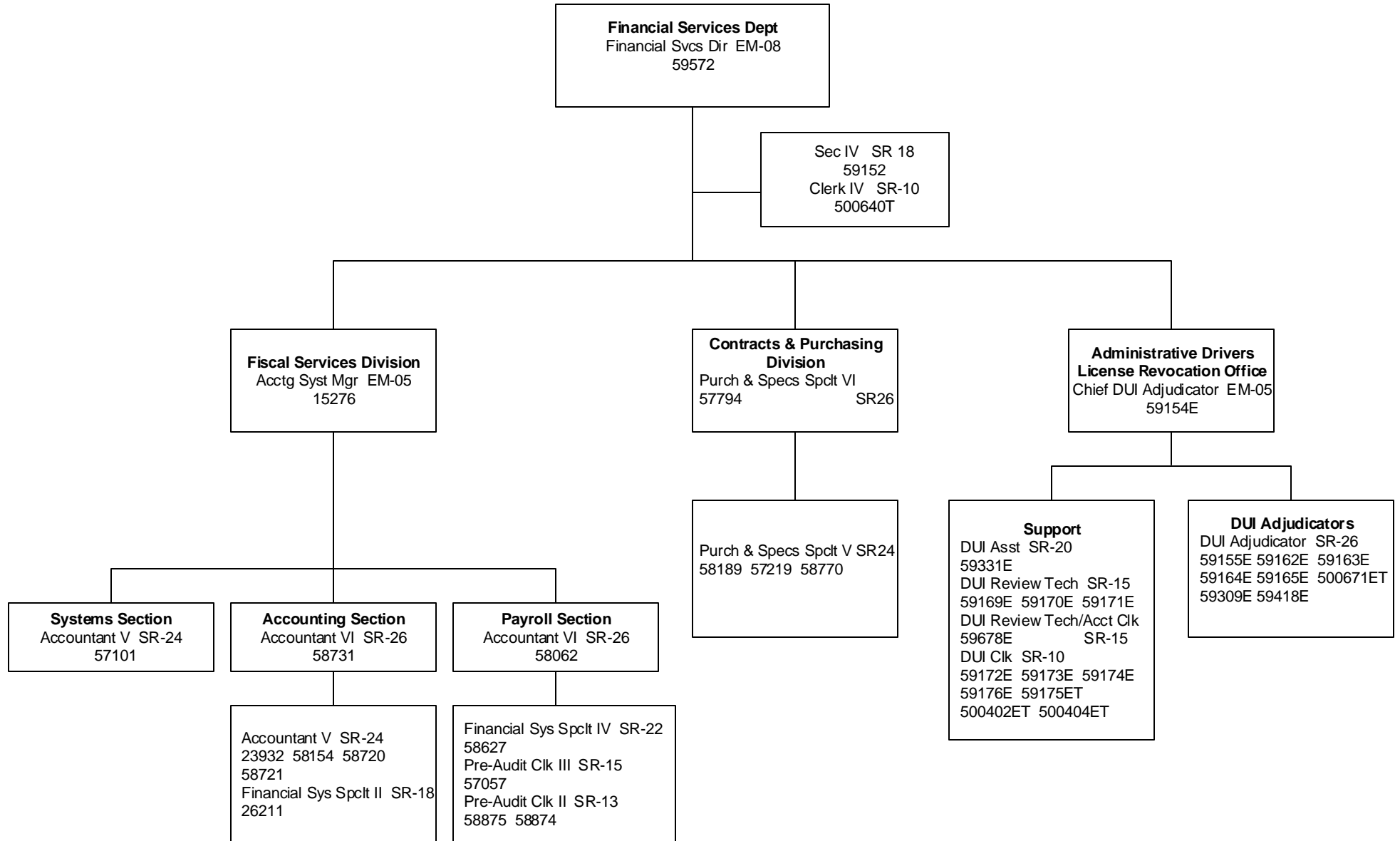

THE JUDICIARY

STATE OF HAWAII

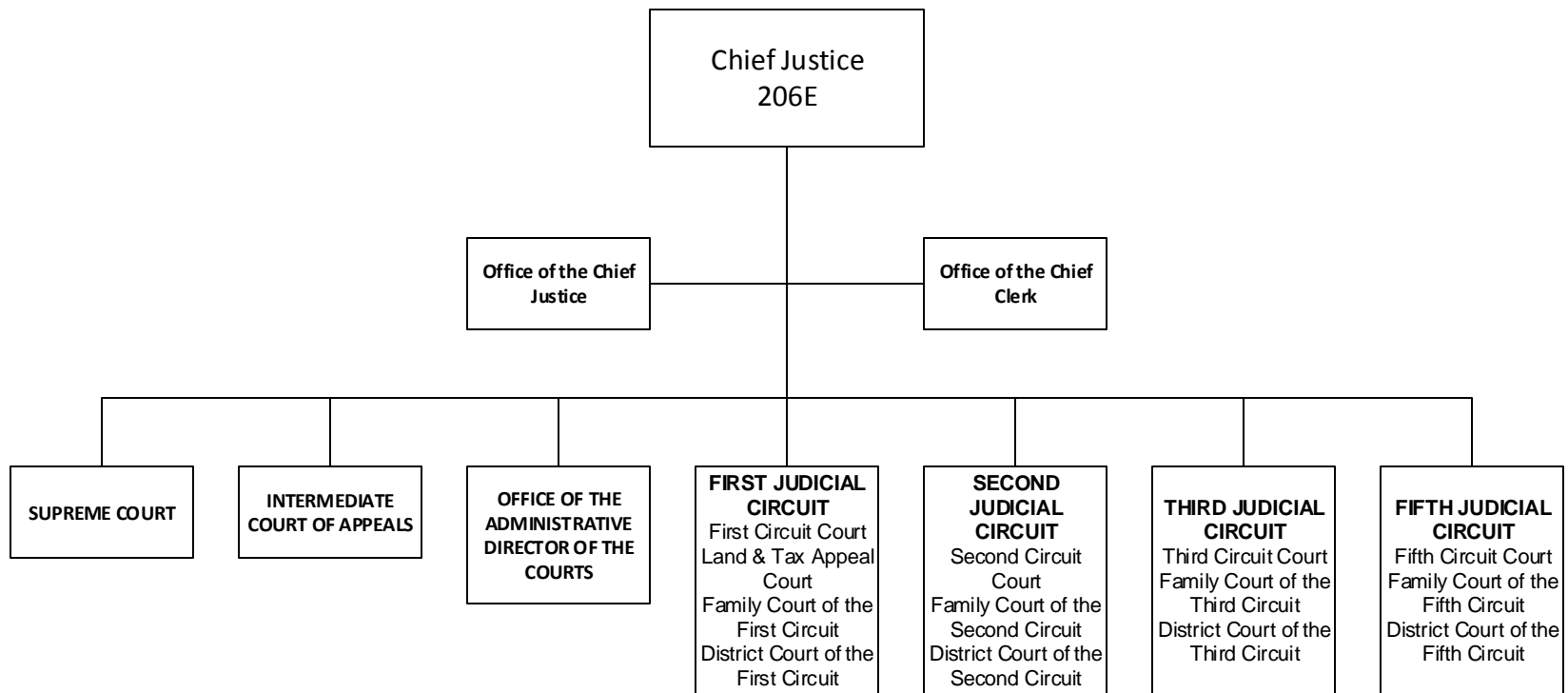

SUPREME COURT Office of the Chief Justice

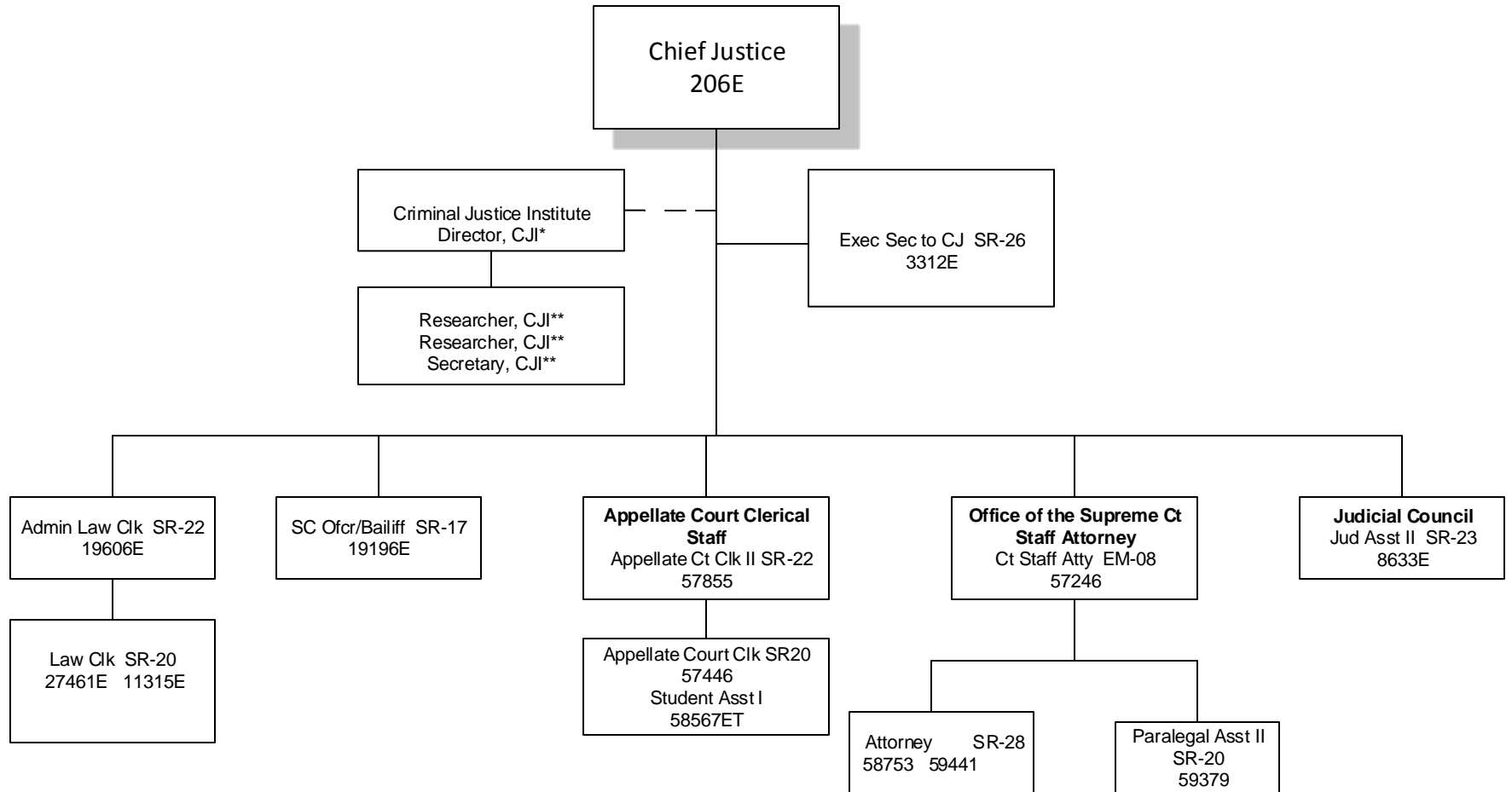

58567ET Student Asst I from 3rd Cir, Leg Docs

*Exempt position to be established. Reports to the Chief Justice for administrative purposes only.

** Exempt positions to be established.

Updated October 2019

SUPREME COURT

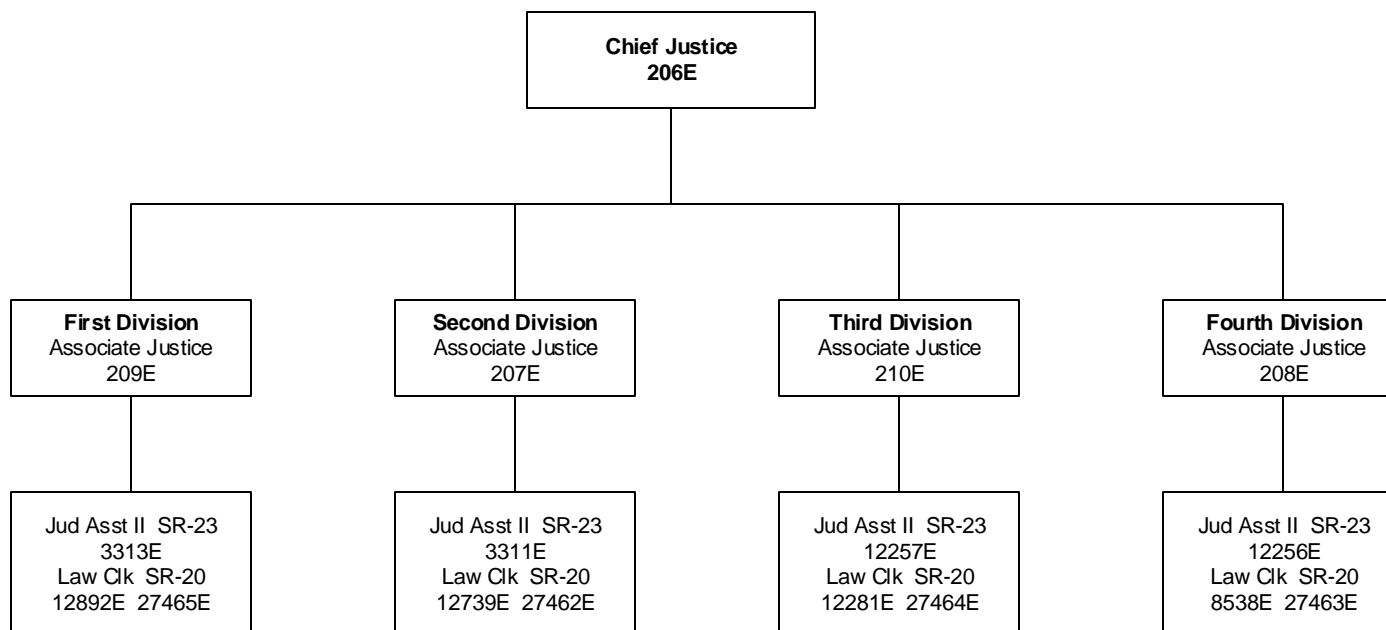

INTERMEDIATE COURT OF APPEALS

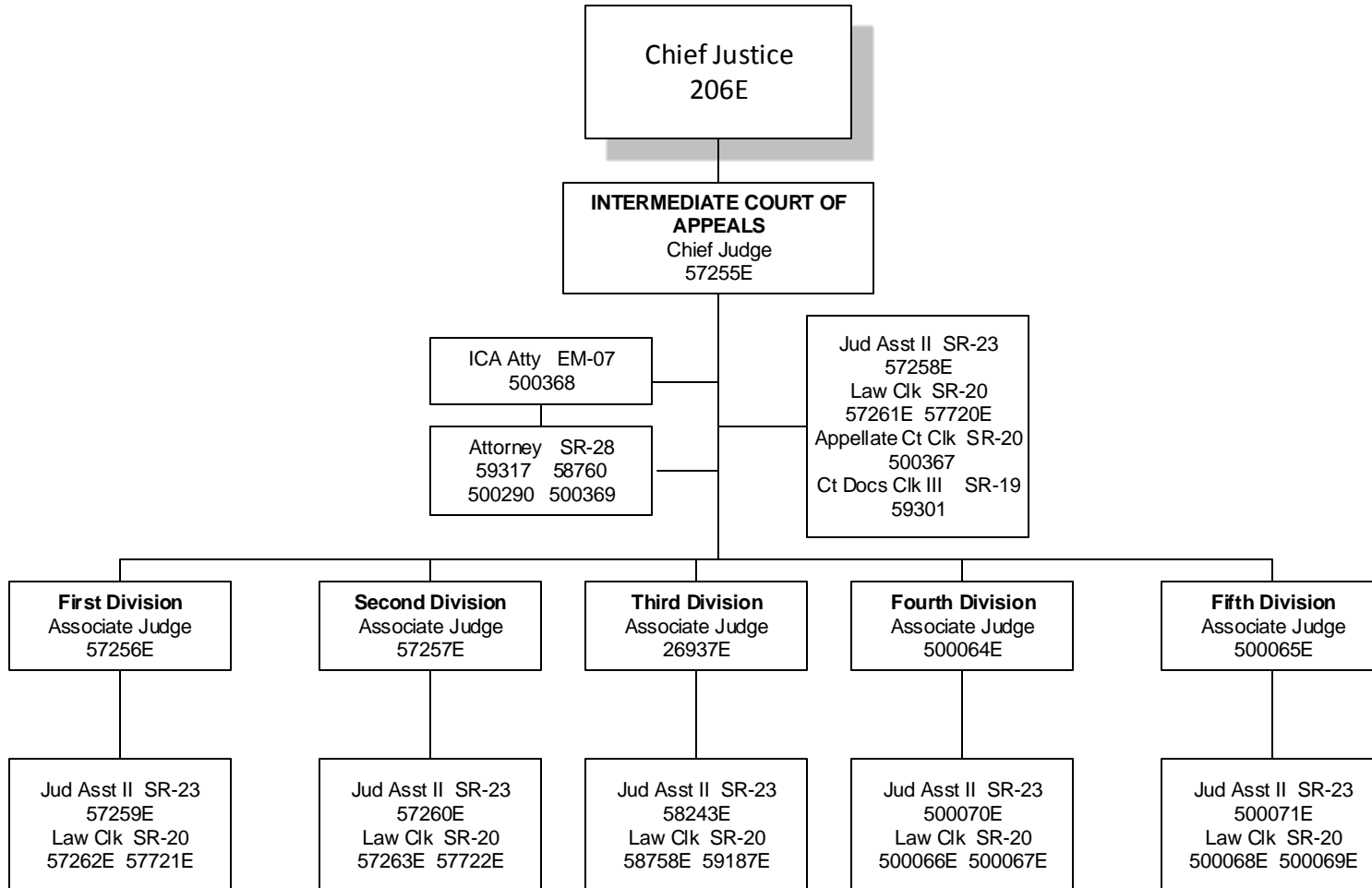

NOTE: Position No. 59301, Appellate Court Clerk, reallocated to Ct Docs Clk III, SR19

Updated January 2018

Courts of Appeal Office of the Chief Clerk

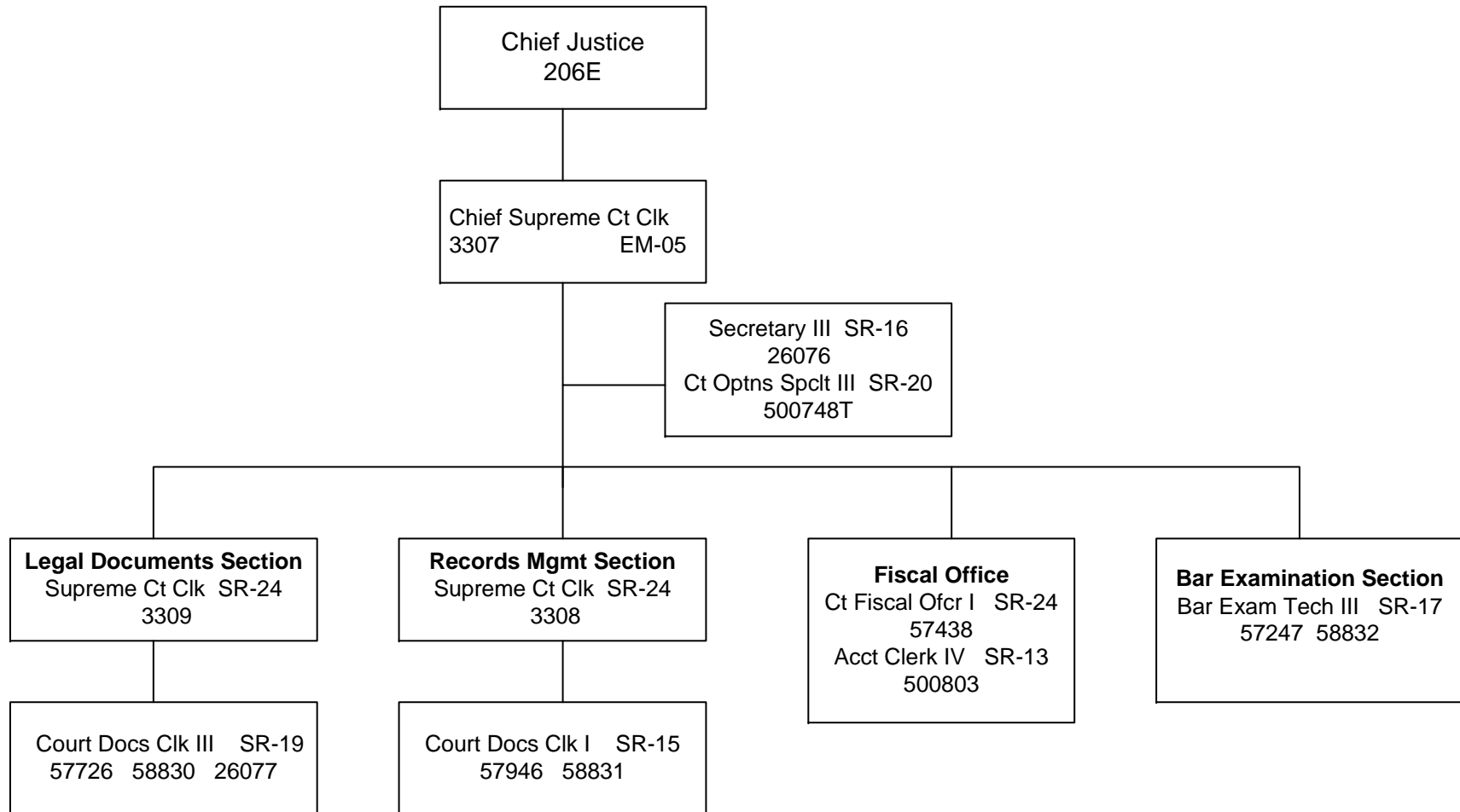

Realloc 500803 to Acct Clk IV
Realloc 58832 to Bar Exam Tech III

Updated September 2018

FIRST JUDICIAL CIRCUIT

CIRCUIT JUDGES

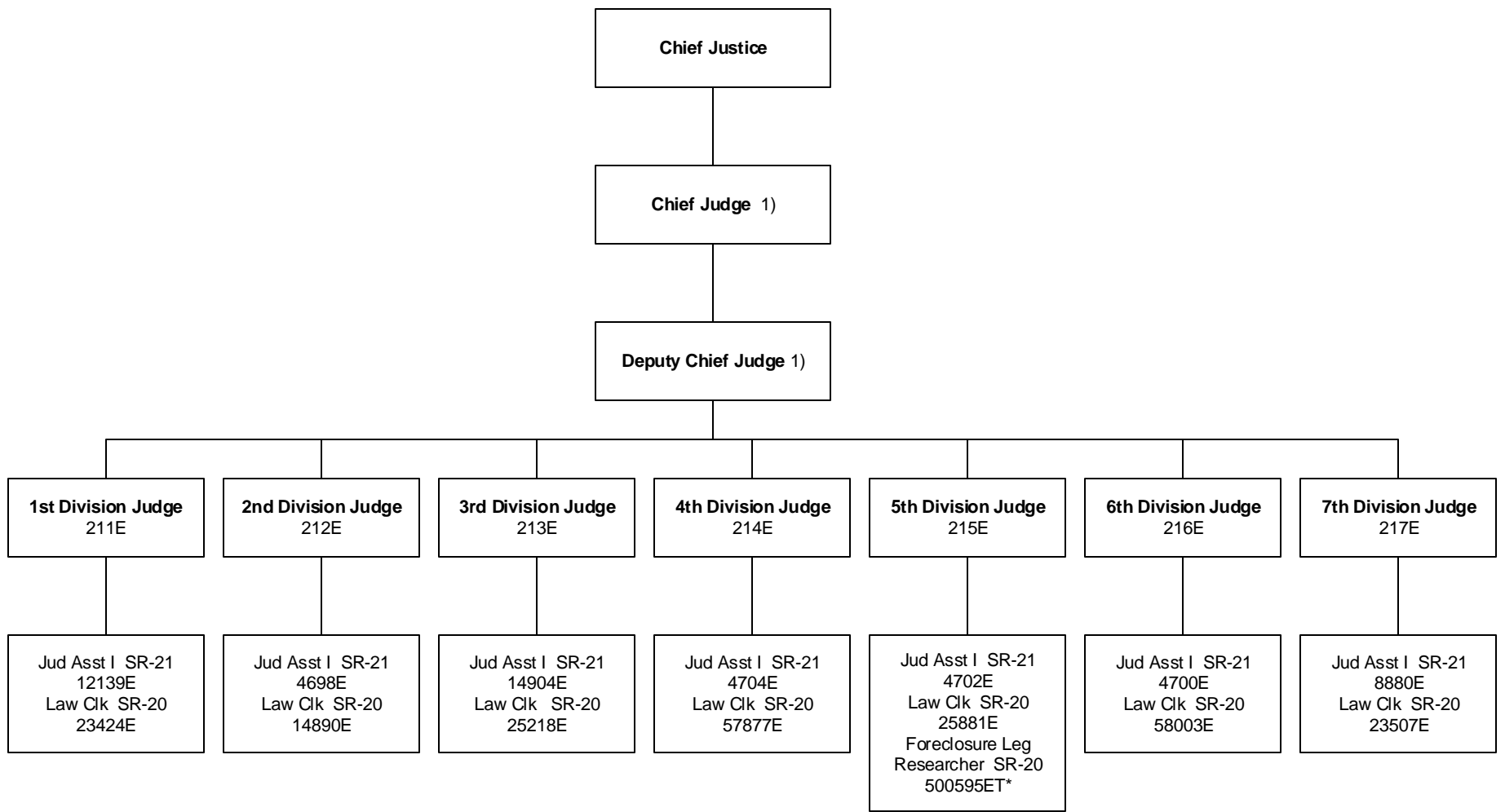

1) Per Chief Justice's order of assignment.

*Psn transferred from 21st Division Judge

Updated December 2017

FIRST JUDICIAL CIRCUIT

CIRCUIT JUDGES

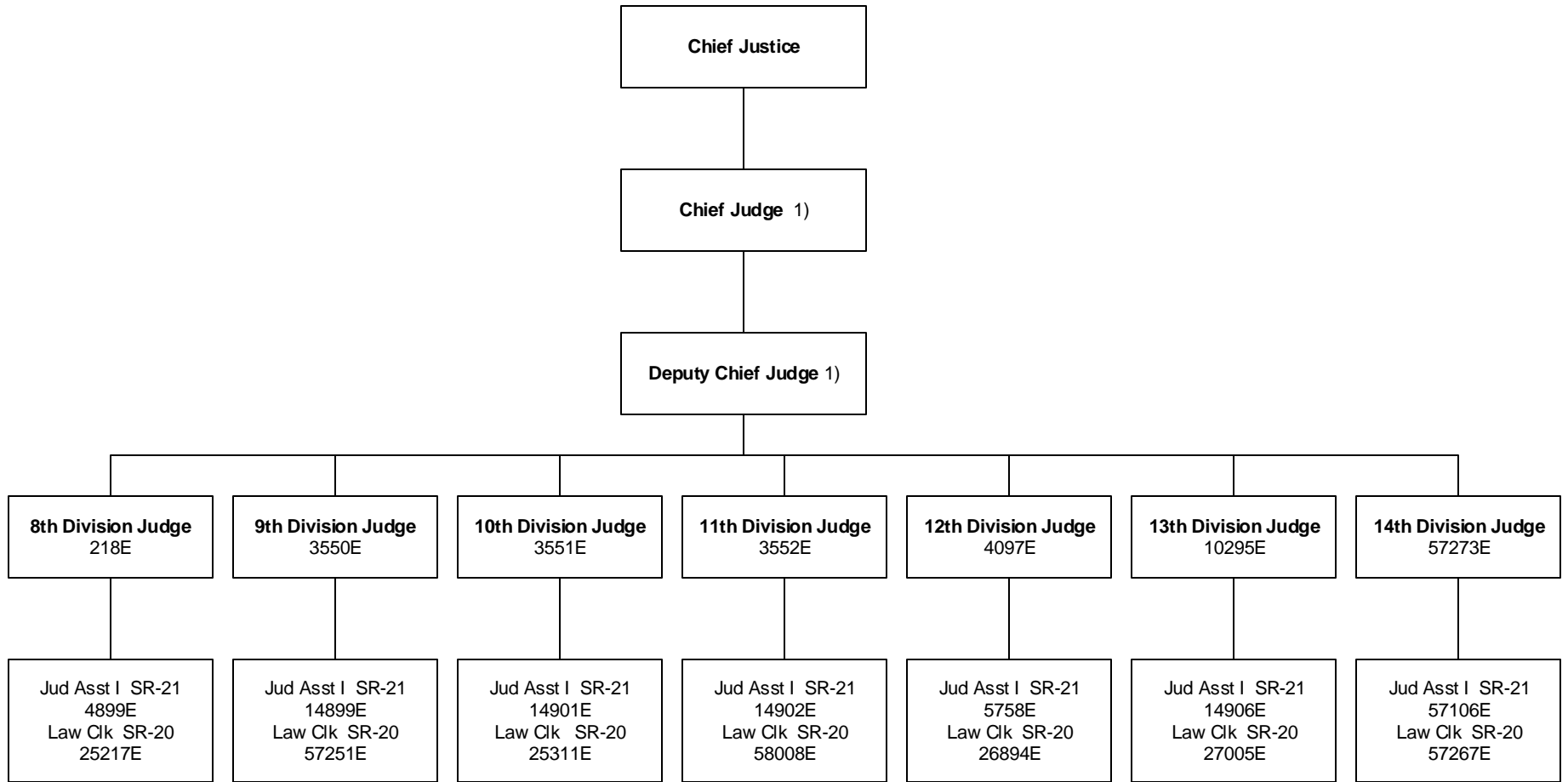

1) Per Chief Justice's order of assignment.

FIRST JUDICIAL CIRCUIT

CIRCUIT JUDGES

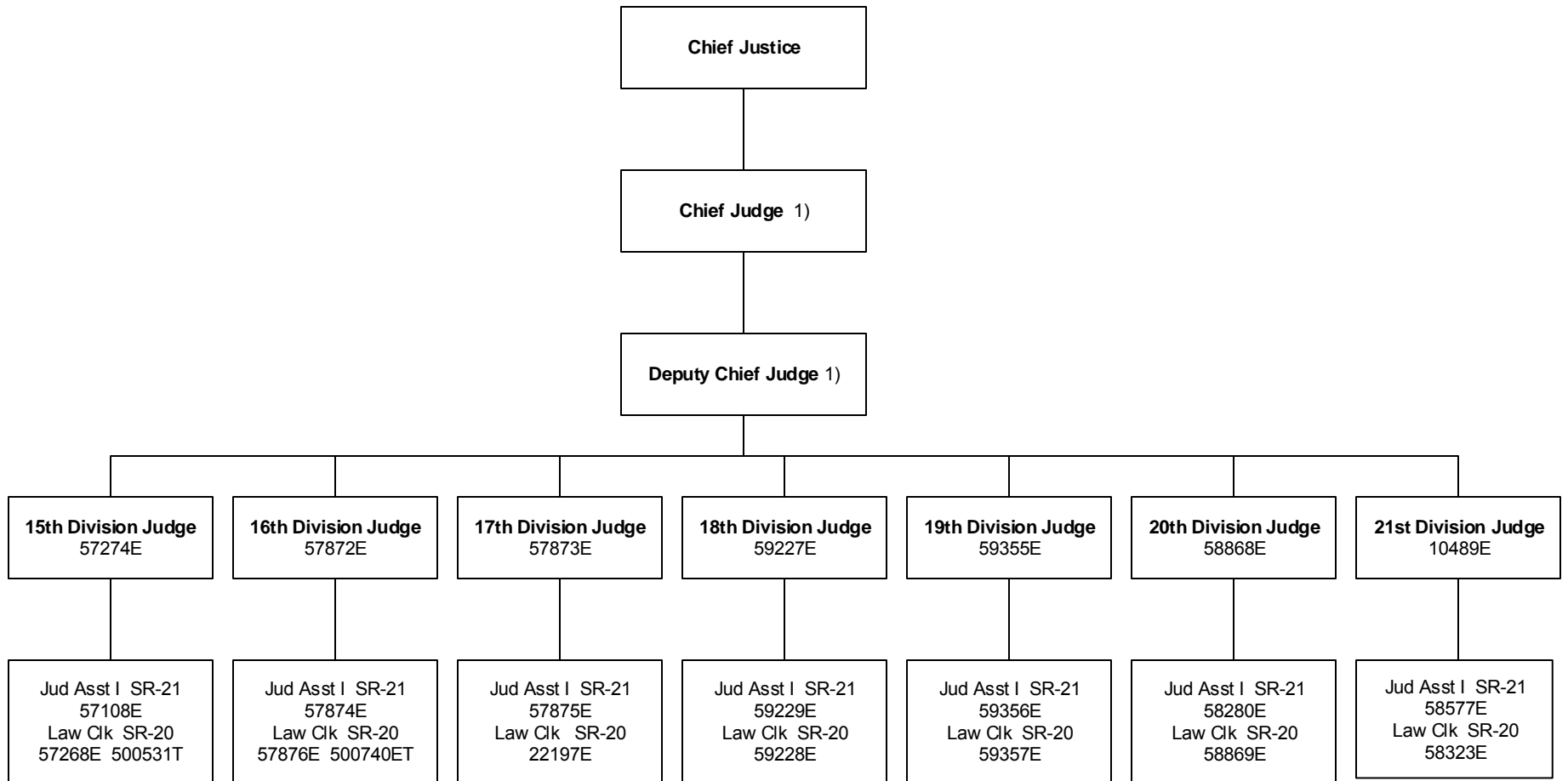

500531T transferred from Det Svcs & realloc to Law Clk

1) Per Chief Justice's order of assignment.

500740ET Law Clk trfr from 22 Div to 16th Div

FIRST JUDICIAL CIRCUIT

CIRCUIT JUDGES

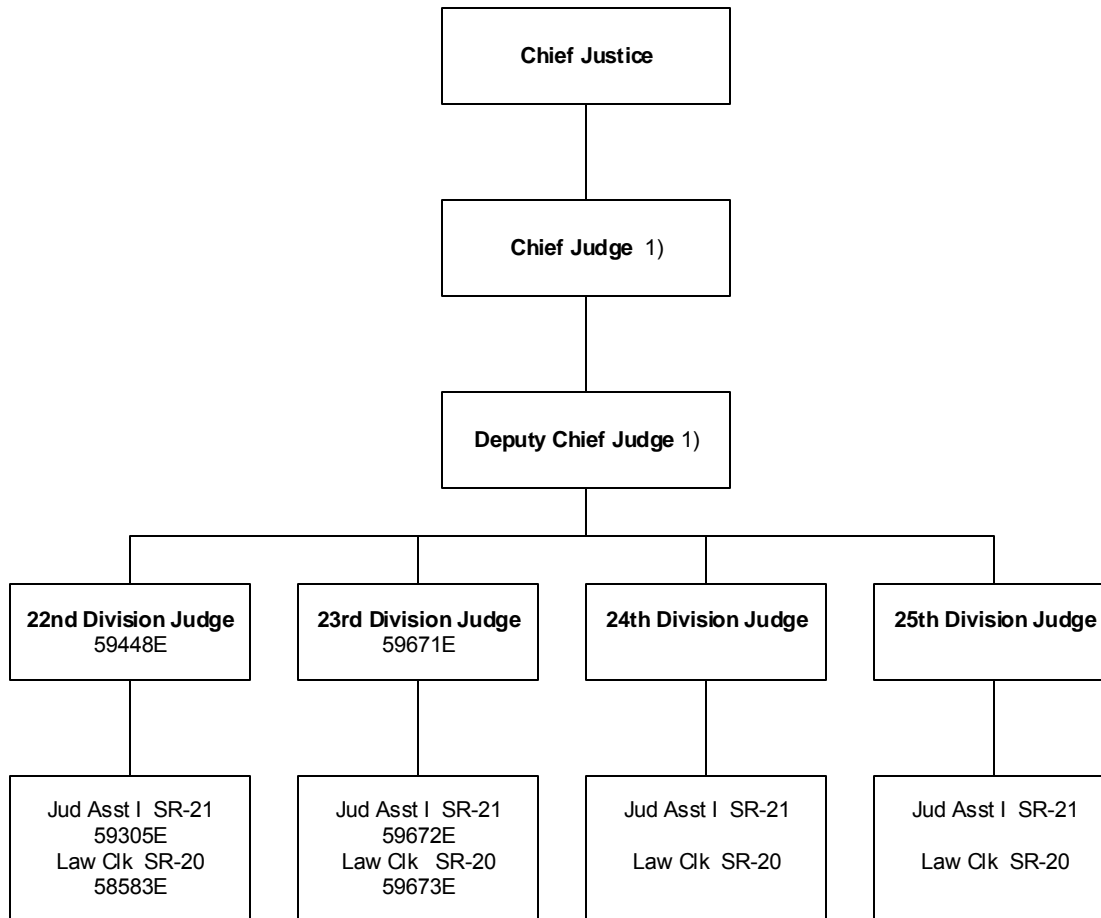

500740ET Law Clk trfr 22 Div to 16th Div

1) Per Chief Justice's order of assignment.

Updated November 2018

FIRST JUDICIAL CIRCUIT

CIVIL ADMINISTRATION

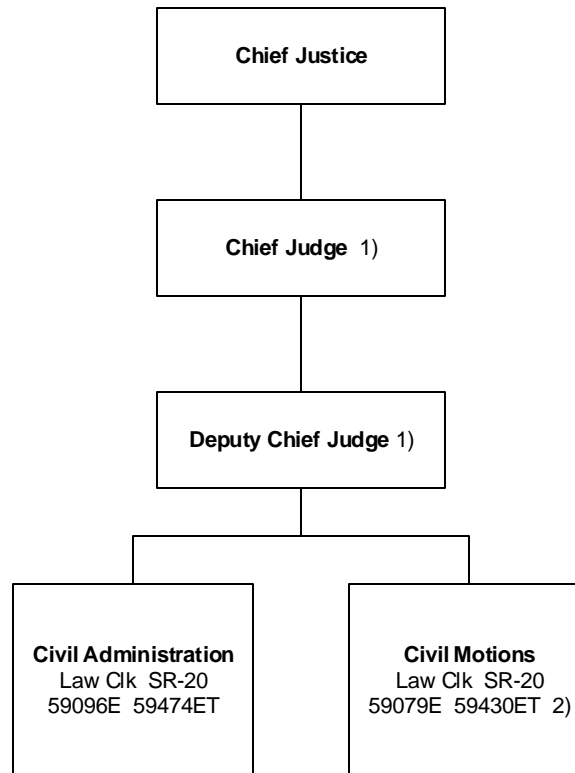

- 1) Per Chief Justice's order of assignment.
- 2) Reports to Civil Motions Judge.

FIRST JUDICIAL CIRCUIT

CRIMINAL ADMINISTRATION

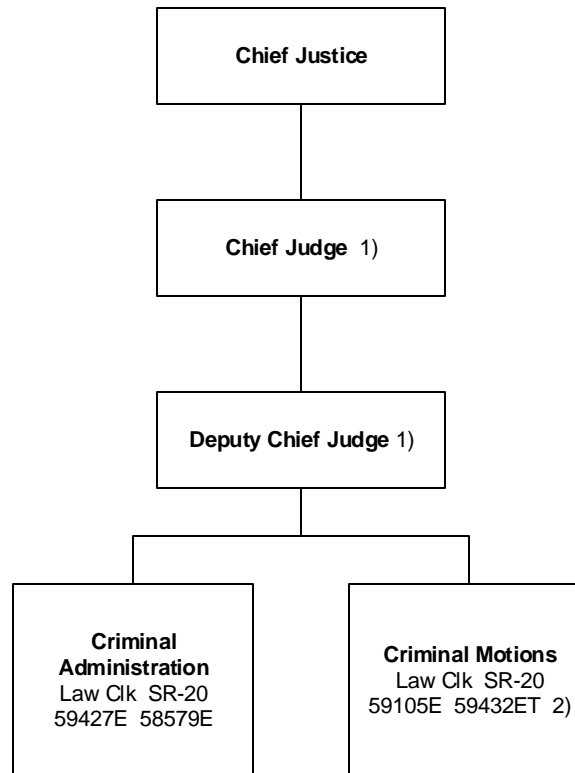

- 1) Per Chief Justice's order of assignment.
- 2) Reports to Criminal Motions Judge.

FIRST CIRCUIT

FAMILY JUDGES

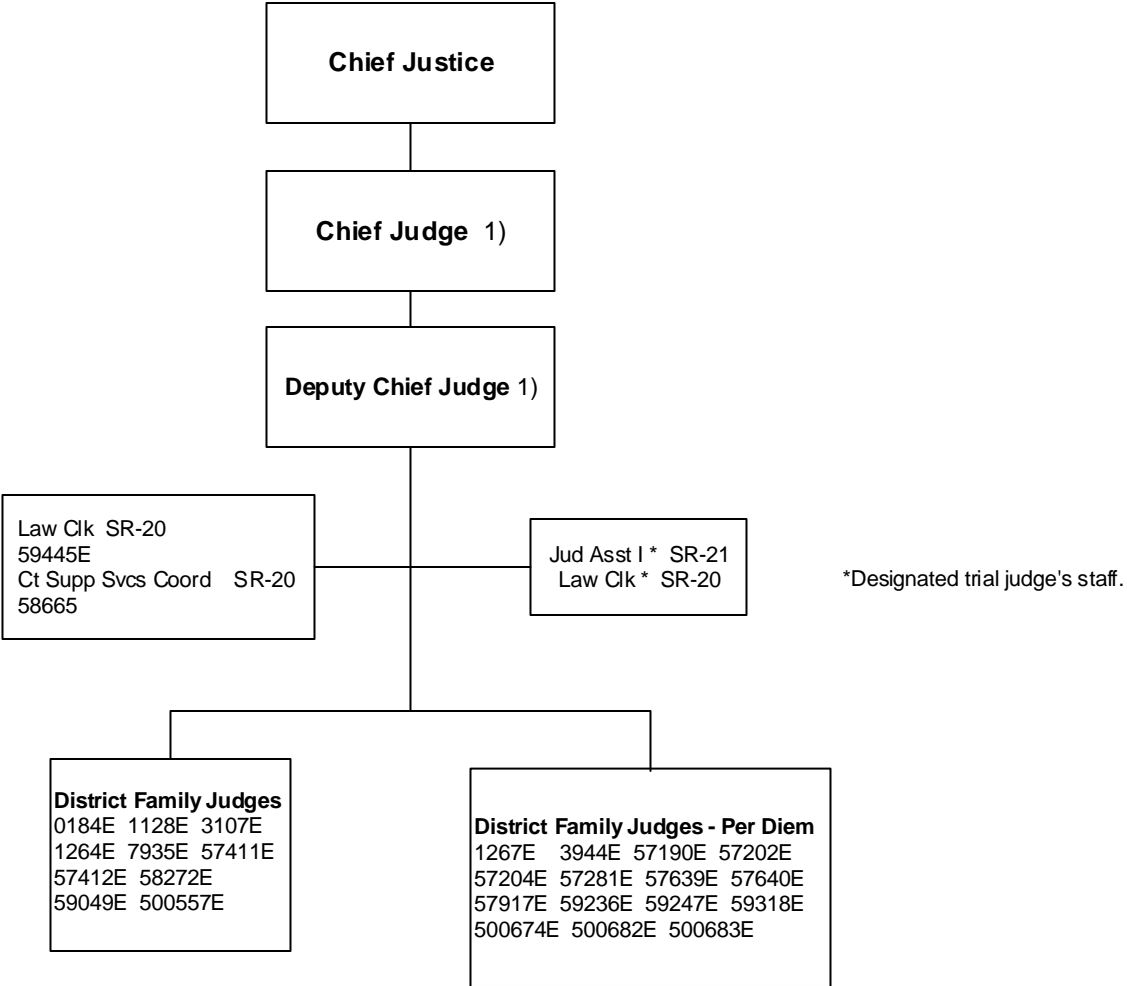

1) Per Chief Justice's order of assignment.

FIRST JUDICIAL CIRCUIT

DISTRICT JUDGES

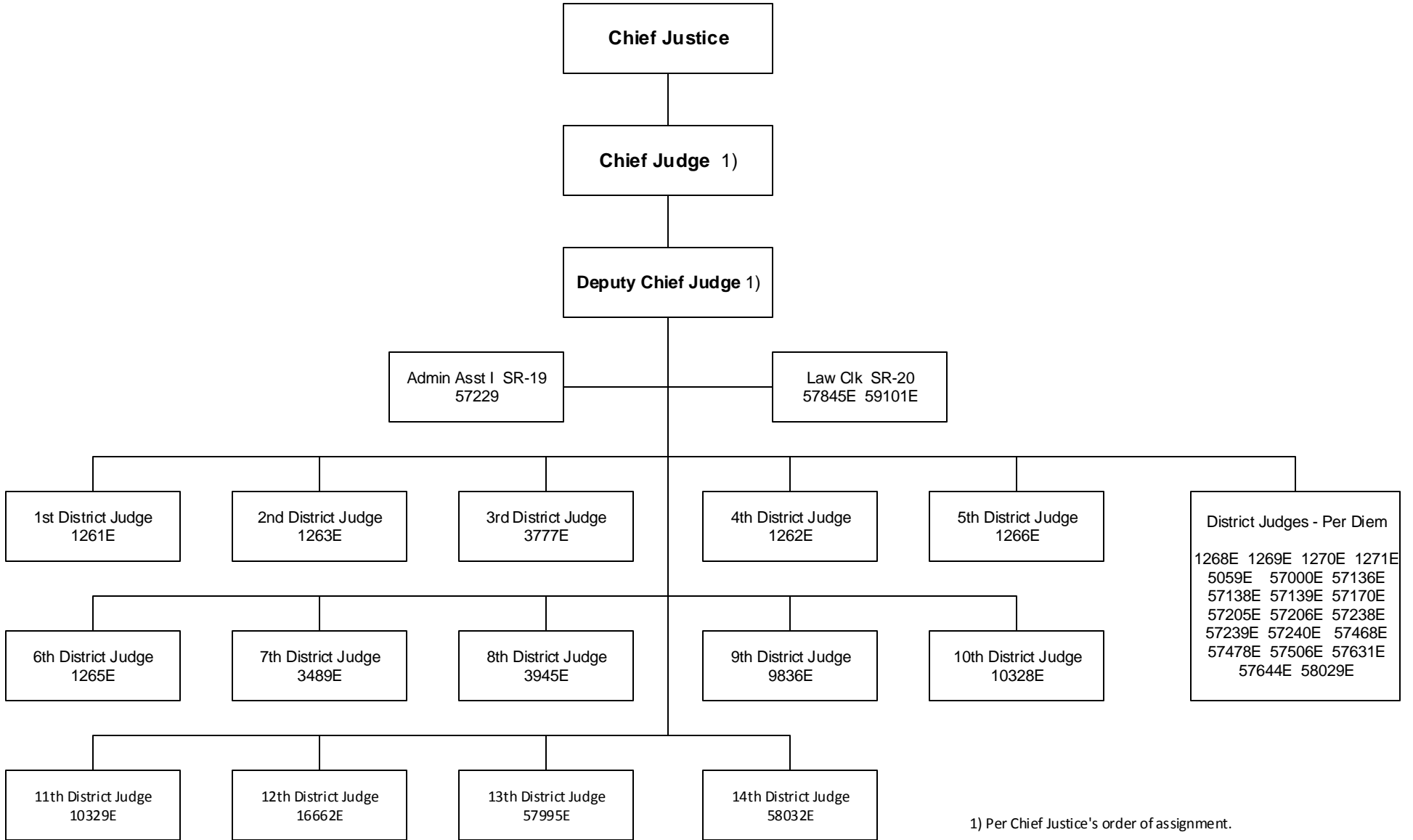

1) Per Chief Justice's order of assignment.

First Circuit

Office of the Chief Court Administrator

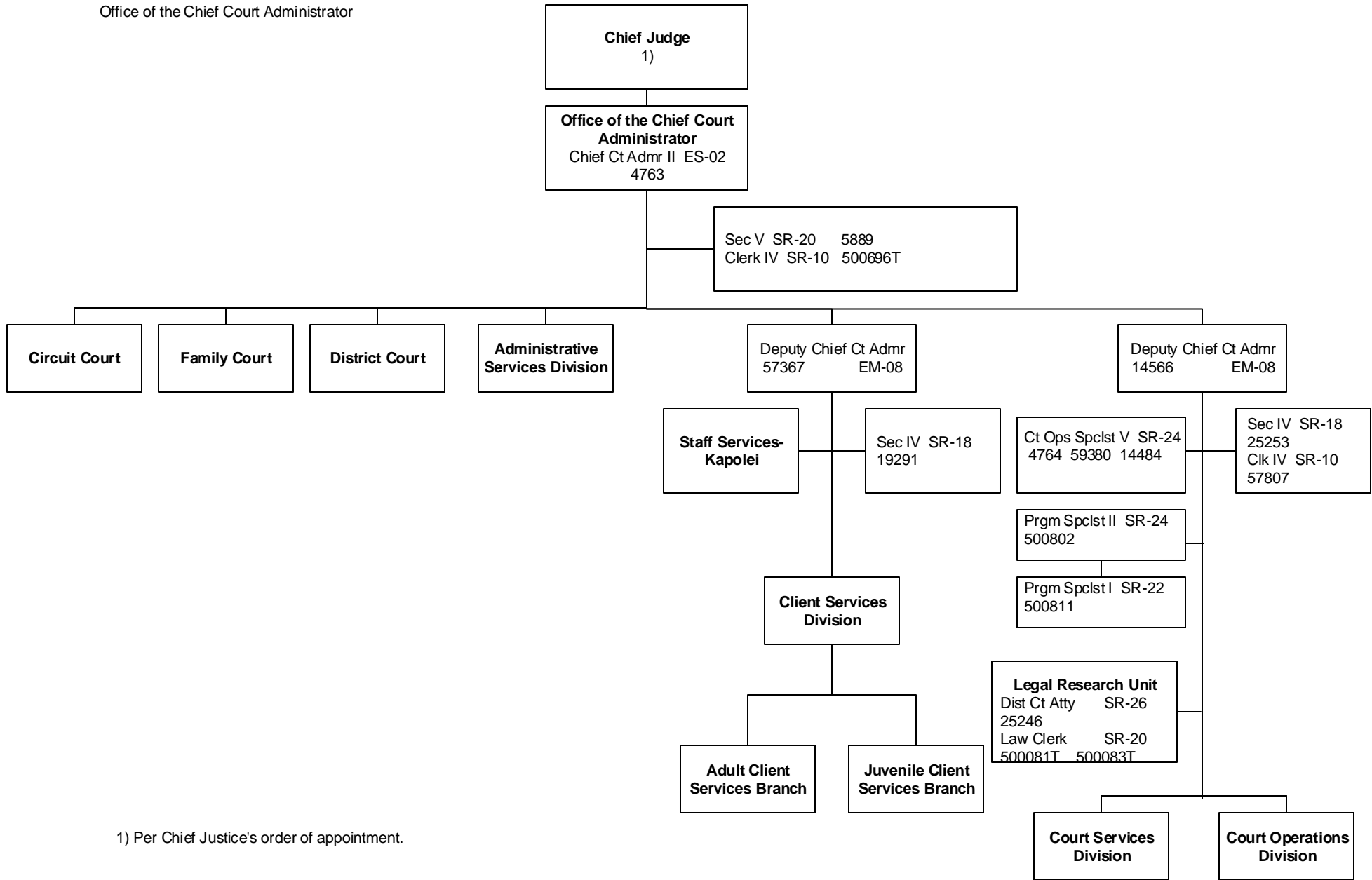

1) Per Chief Justice's order of appointment.

First Circuit

Administrative Services Division

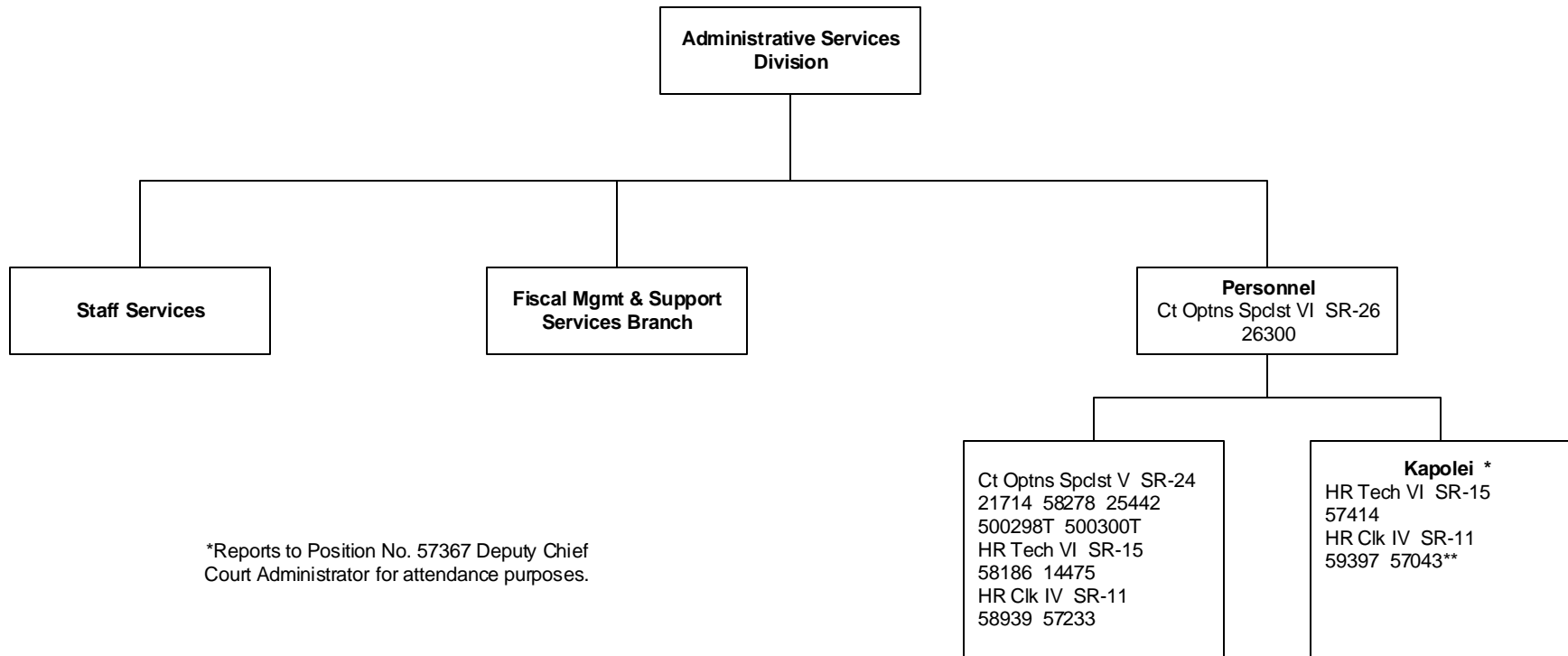

*Reports to Position No. 57367 Deputy Chief Court Administrator for attendance purposes.

**Position no. 57043, Secretary II, transferred from Detention Services and redescribed

Updated December 2017

First Circuit

Administrative Services Division

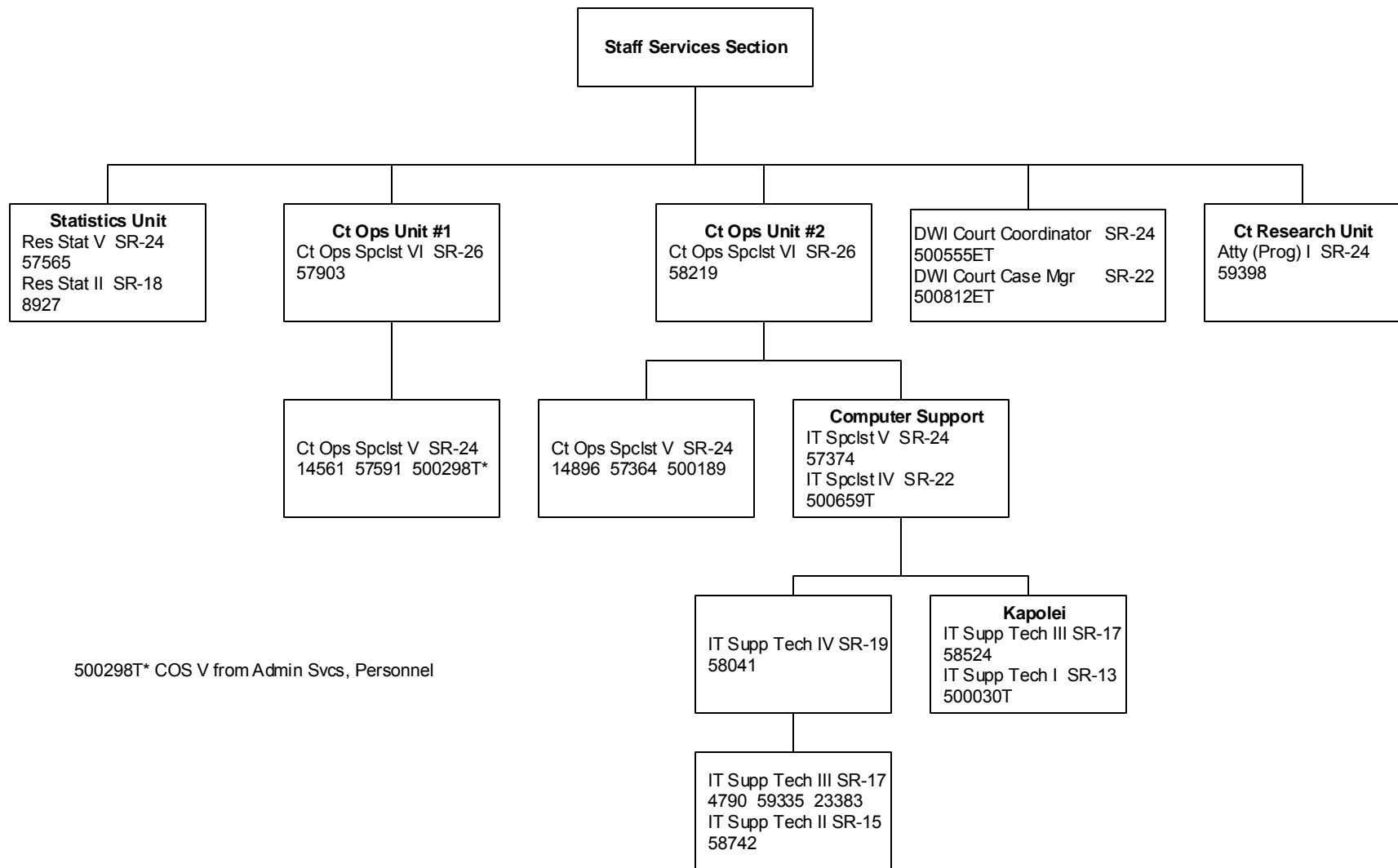

500298T* COS V from Admin Svcs, Personnel

First Circuit

Administrative Services Division

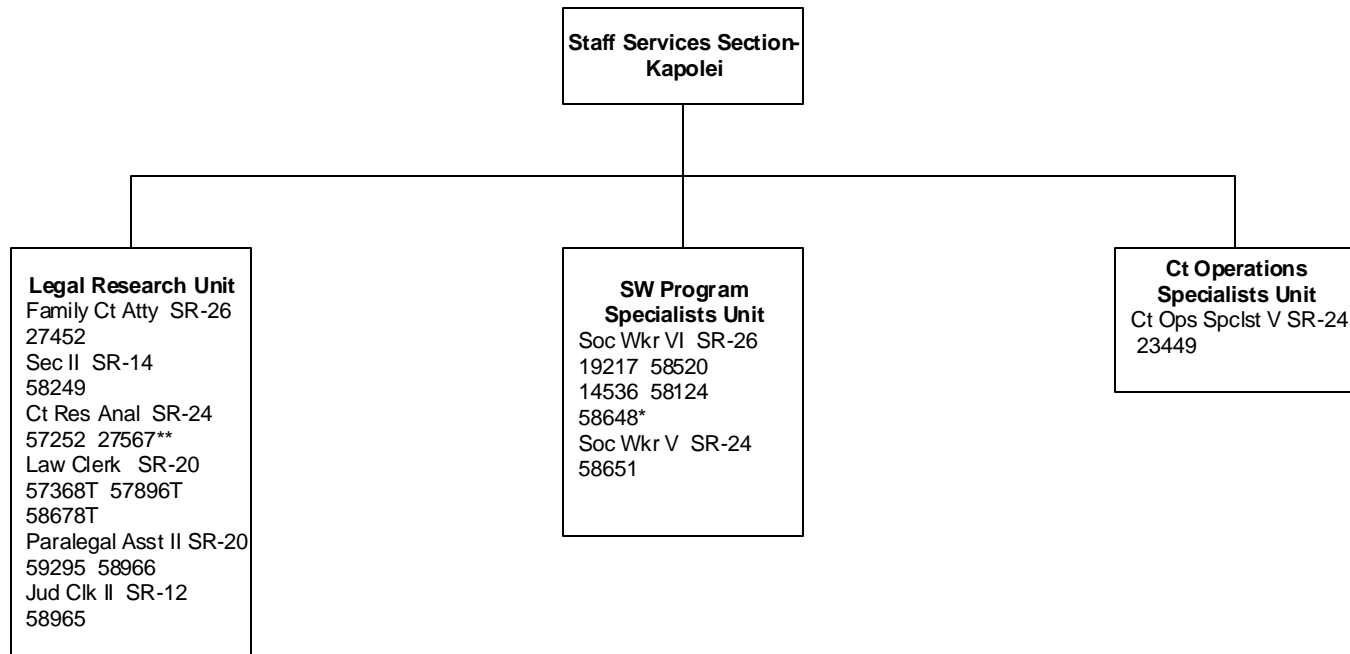

*Position will report to the Deputy Chief Court Administrator. Position will remain in Honolulu until such time that space becomes available in Kapolei
**Position No. 27567 was transferred from CSD, JCSB-Special Svcs and redescribed to Ct Res Anal.

NOTE:
Position no. 19378, SW V transferred to JCSB

First Circuit

Administrative Services Division

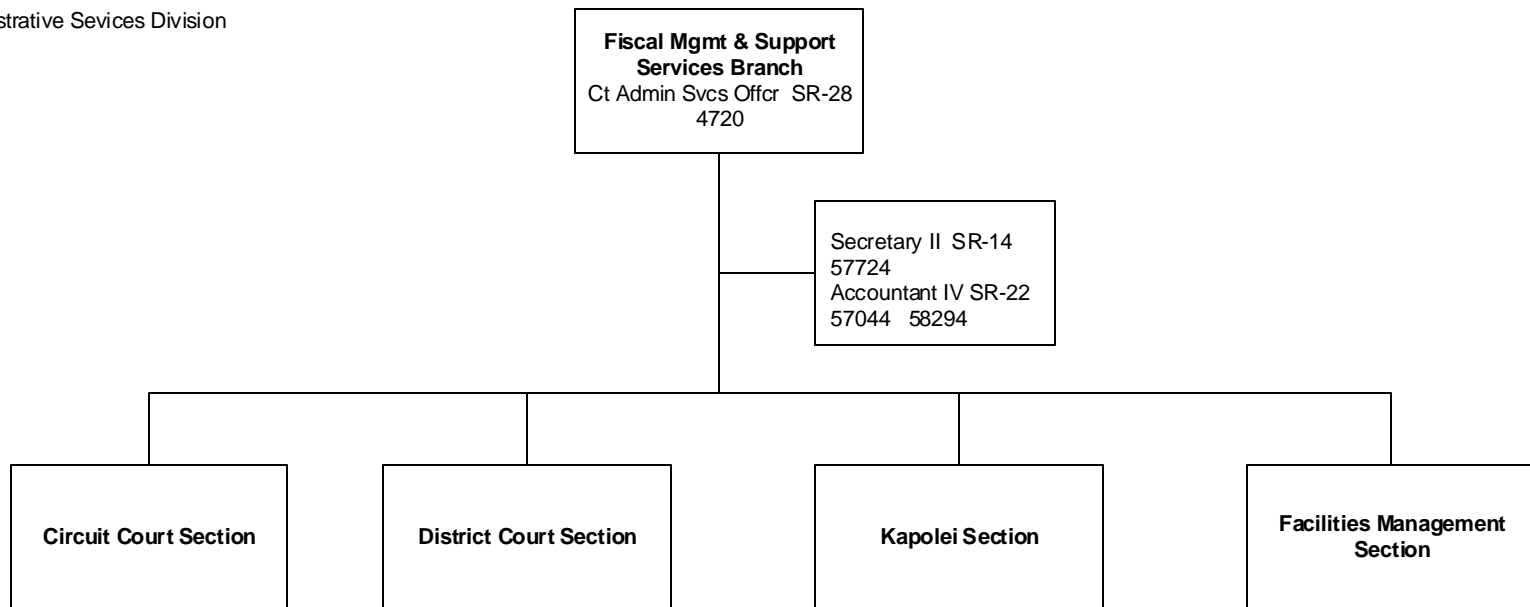

Updated December 2017

First Circuit

Administrative Services Division
Fiscal Mgmt & Support Services Branch

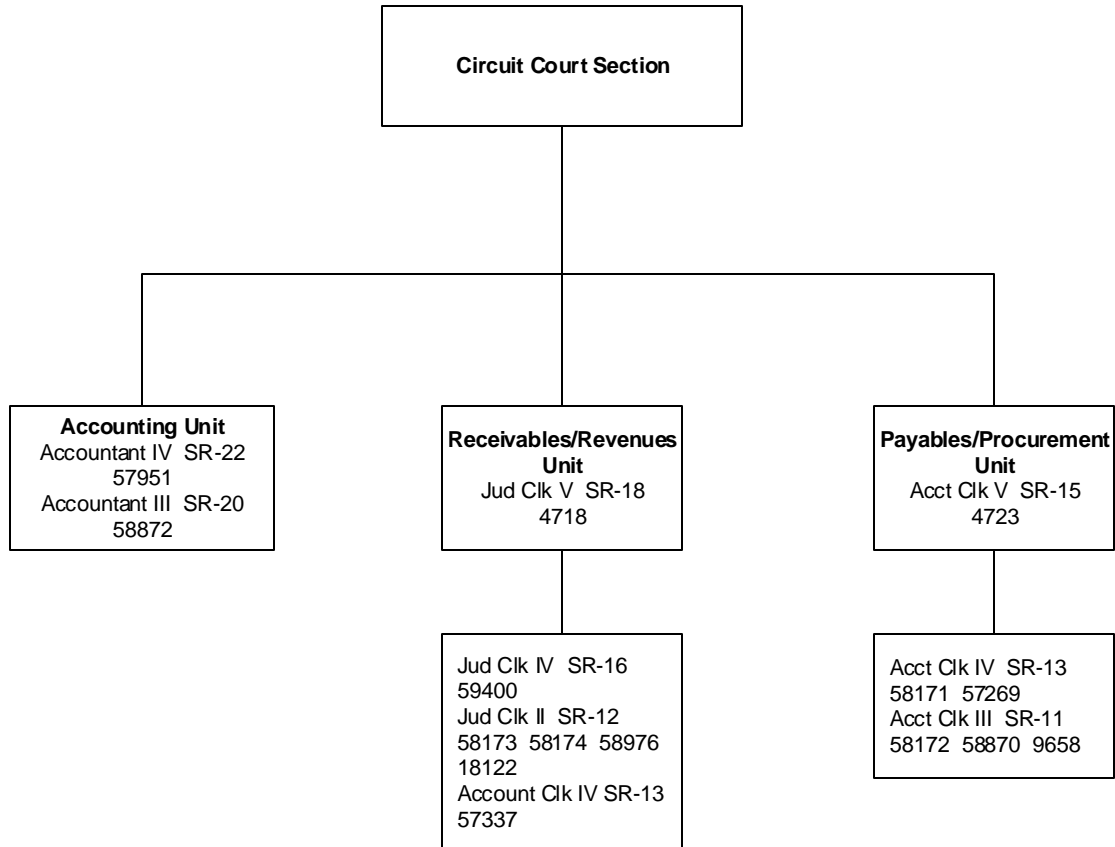

First Circuit

Administrative Services Division
Fiscal Mgmt & Support Services Branch

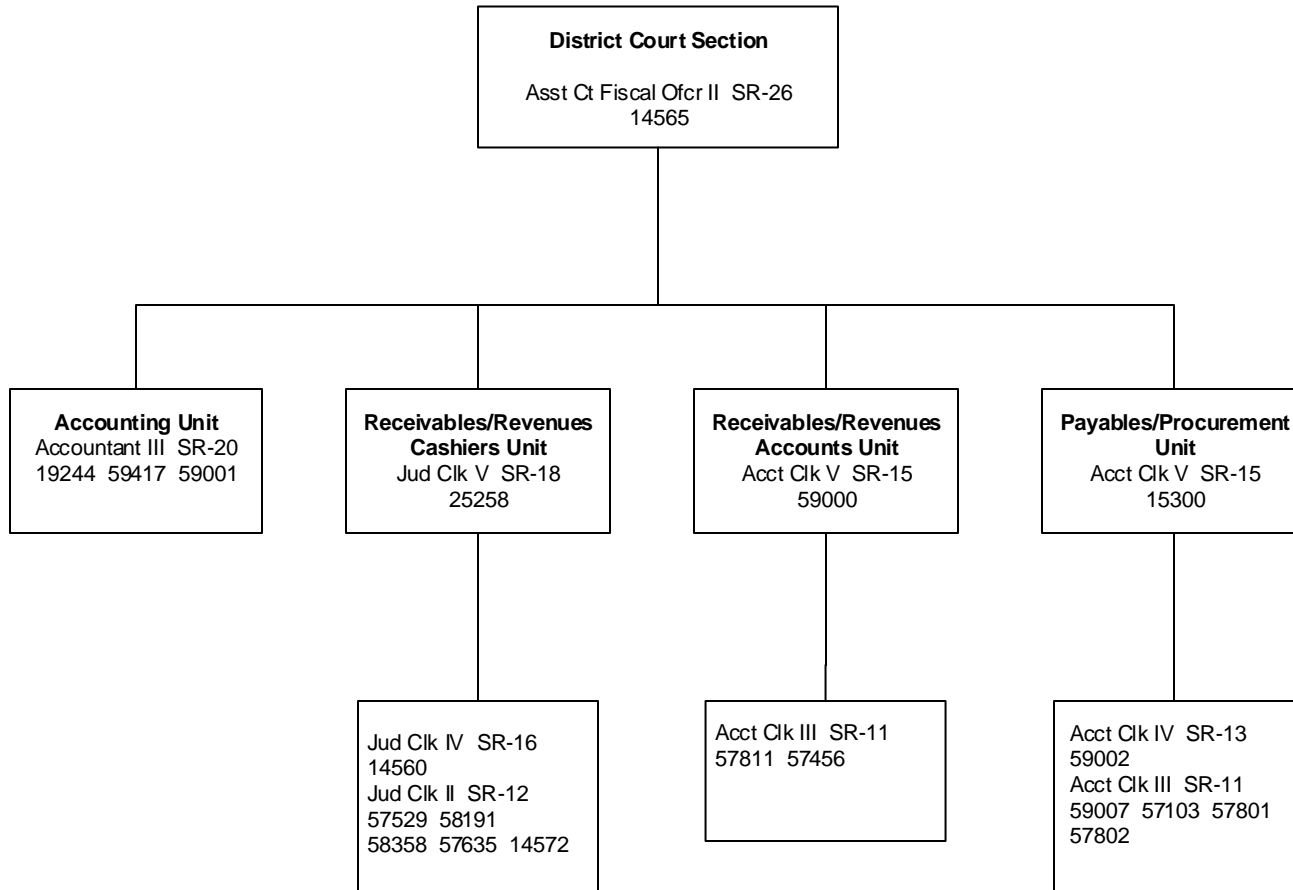

First Circuit

Administrative Services Division
Fiscal Mgmt & Support Services Branch

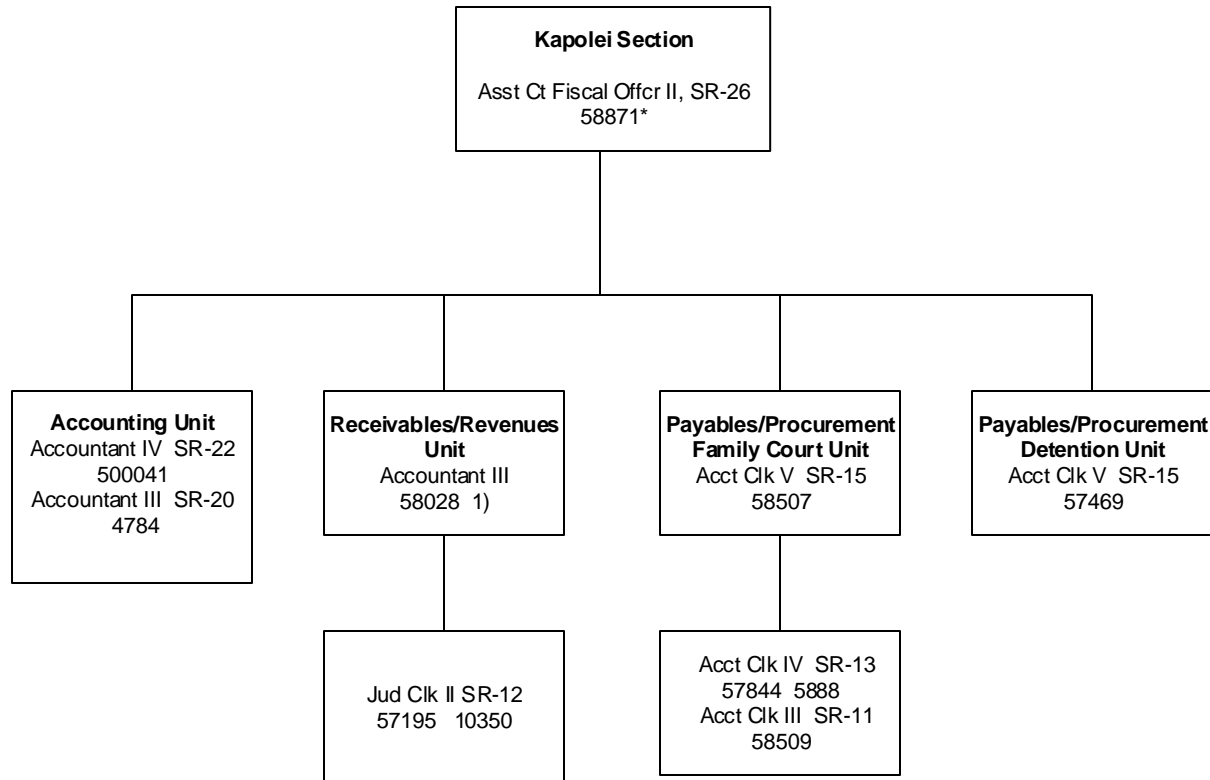

*Reports to Position No. 57367 Deputy Chief Court Administrator for attendance purposes.

1) Position classification to be reviewed.

Updated October 2019

First Circuit

Administrative Services Division
Fiscal Mgmt & Support Services Branch

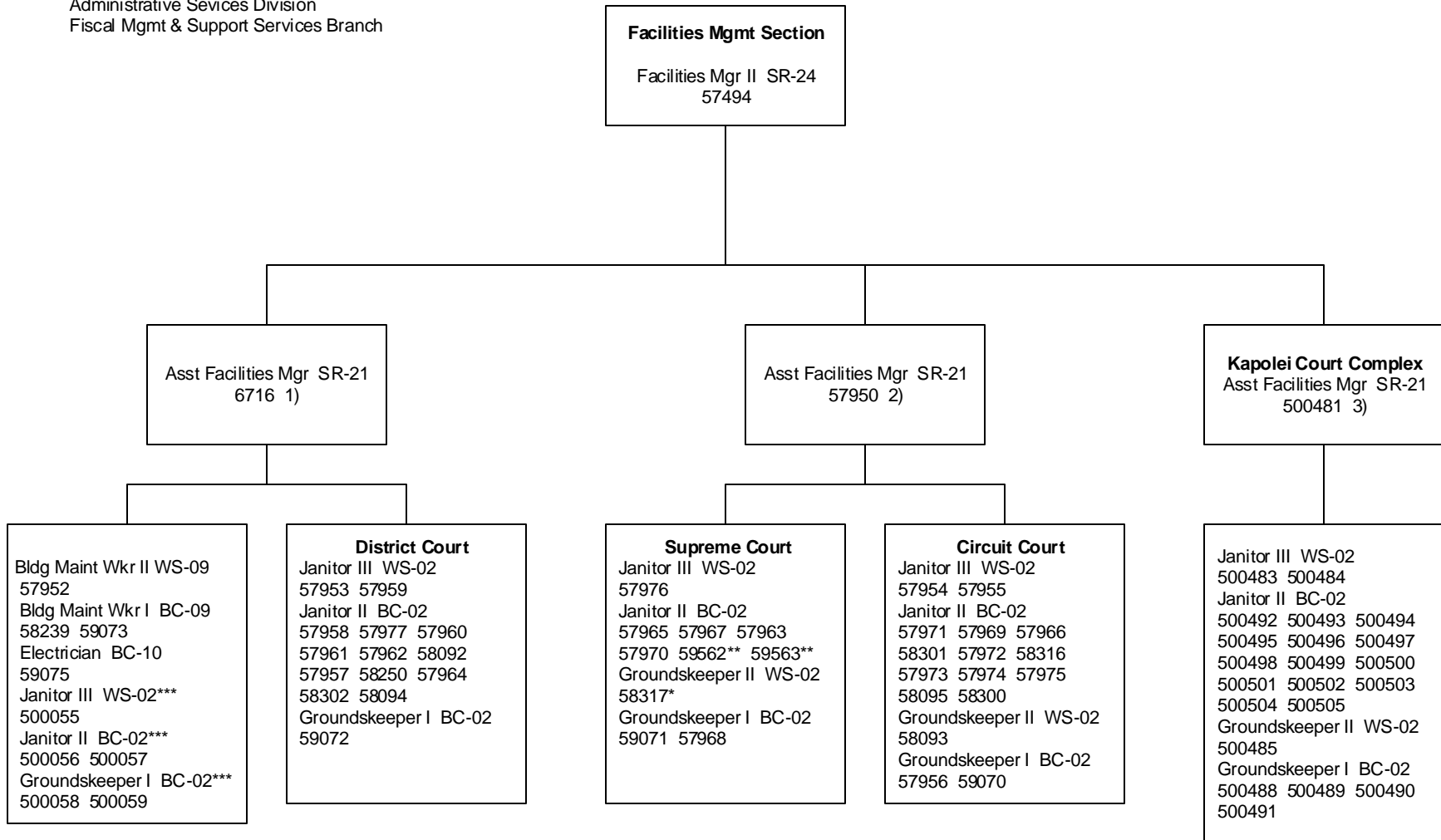

*Responsible for DC & SC.

**Assigned to Kapuaiwa Hale (#59562 & 59563).

*** Assigned to Abner Paki Hale-Kaneohe.

1) Also responsible for Kaneohe District Court. Responsible for other buildings in the absence of other Asst Facilities Mgrs.

2) Responsible for other buildings in the absence of other Asst Facilities Mgrs.

3) Reports to Position No. 58871 Asst Court Fiscal Officer II for attendance purposes. Also responsible for Ewa and Wahiawa District Courts.

First Circuit

Client Services Division
Adult Client Services Branch

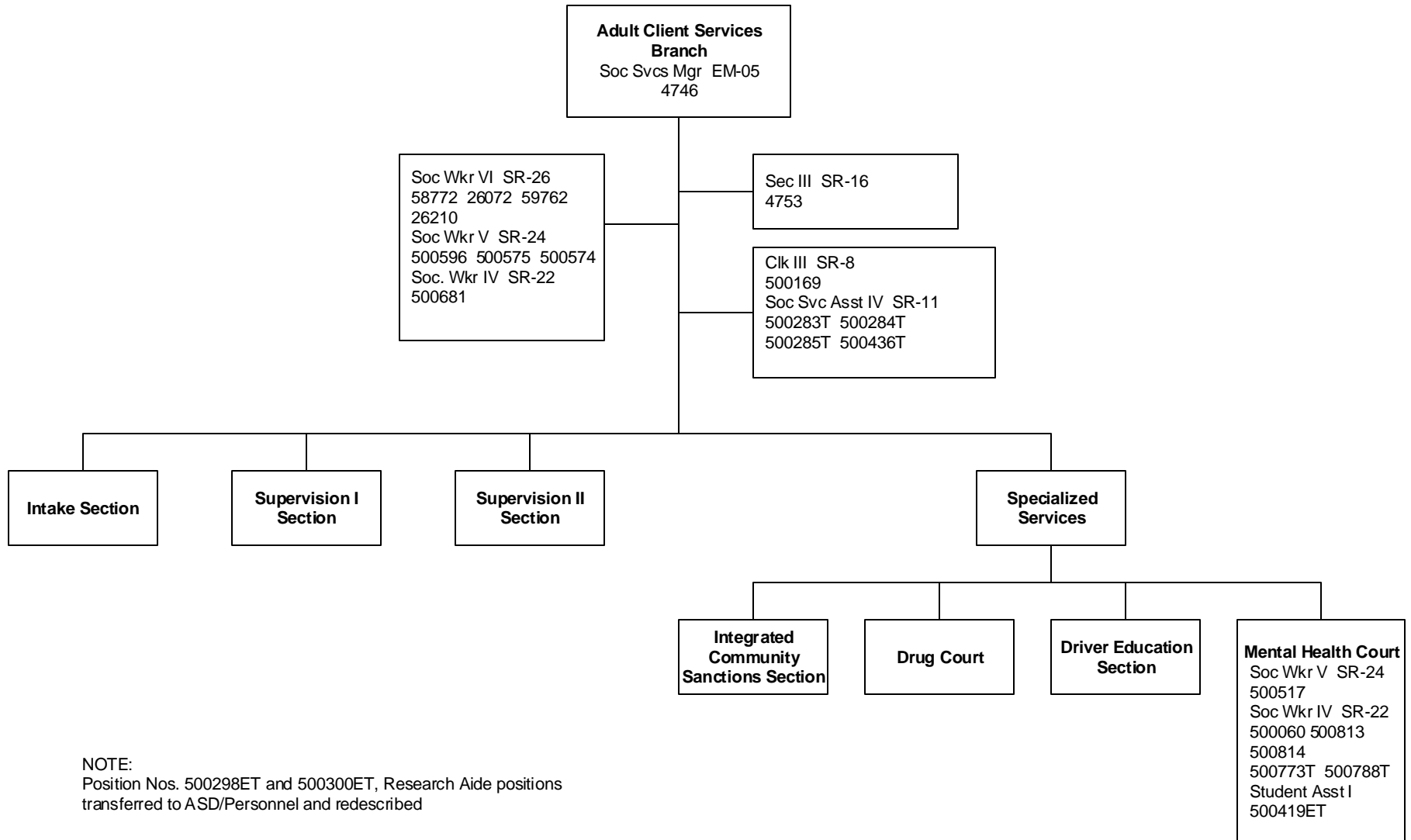

NOTE:
Position Nos. 500298ET and 500300ET, Research Aide positions transferred to ASD/Personnel and redescribed

Established new SW IV psns 500813 & 500814
authorized by Act 95, SLH2017

Updated September 2018

First Circuit

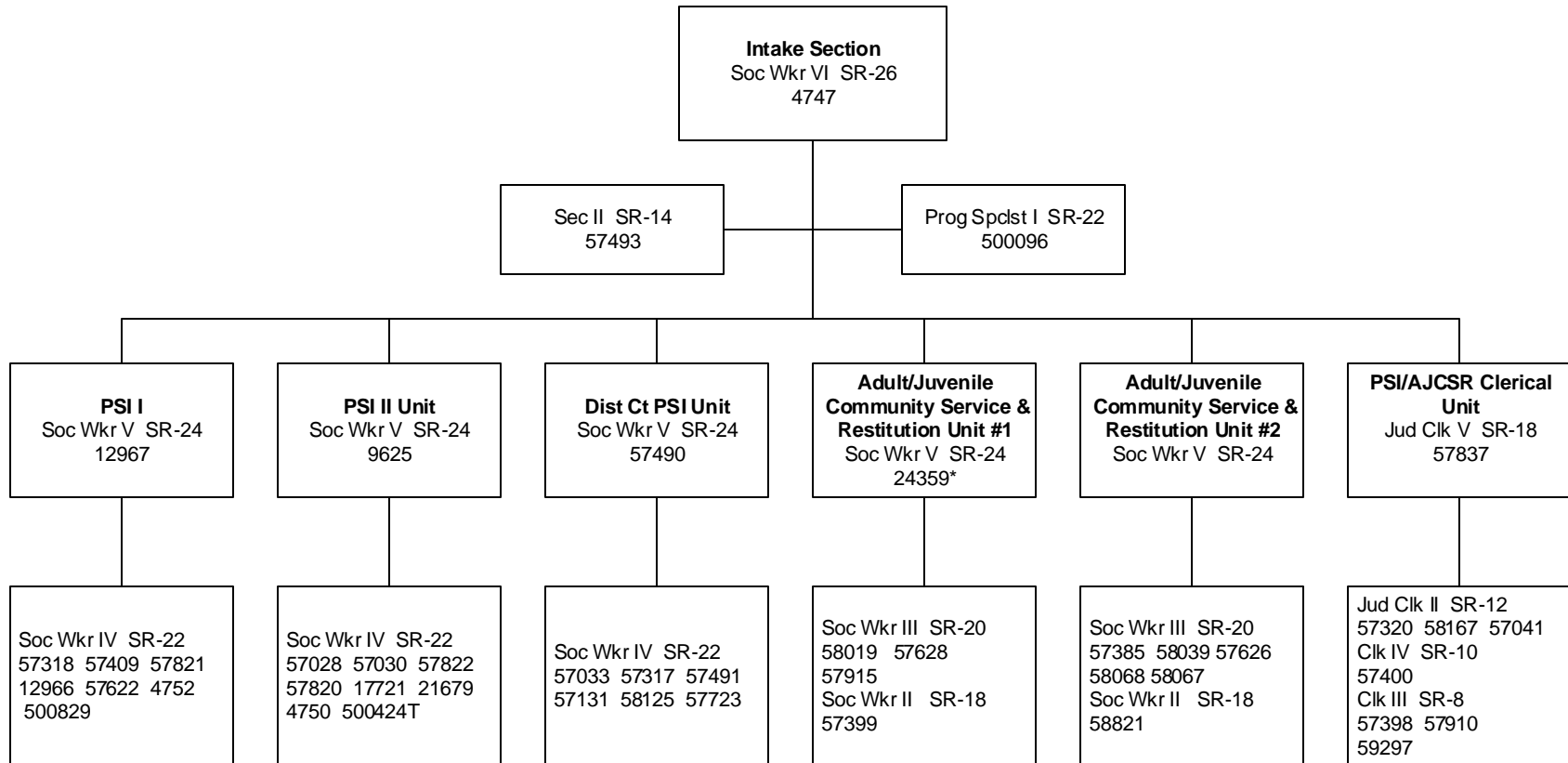

Estab perm SW IV 500829 authorized
by Act 26, SLH2018

*Also supervises AJCSR Unit #2

Updated October 2018

First Circuit

Client Services Division
Adult Client Services Branch

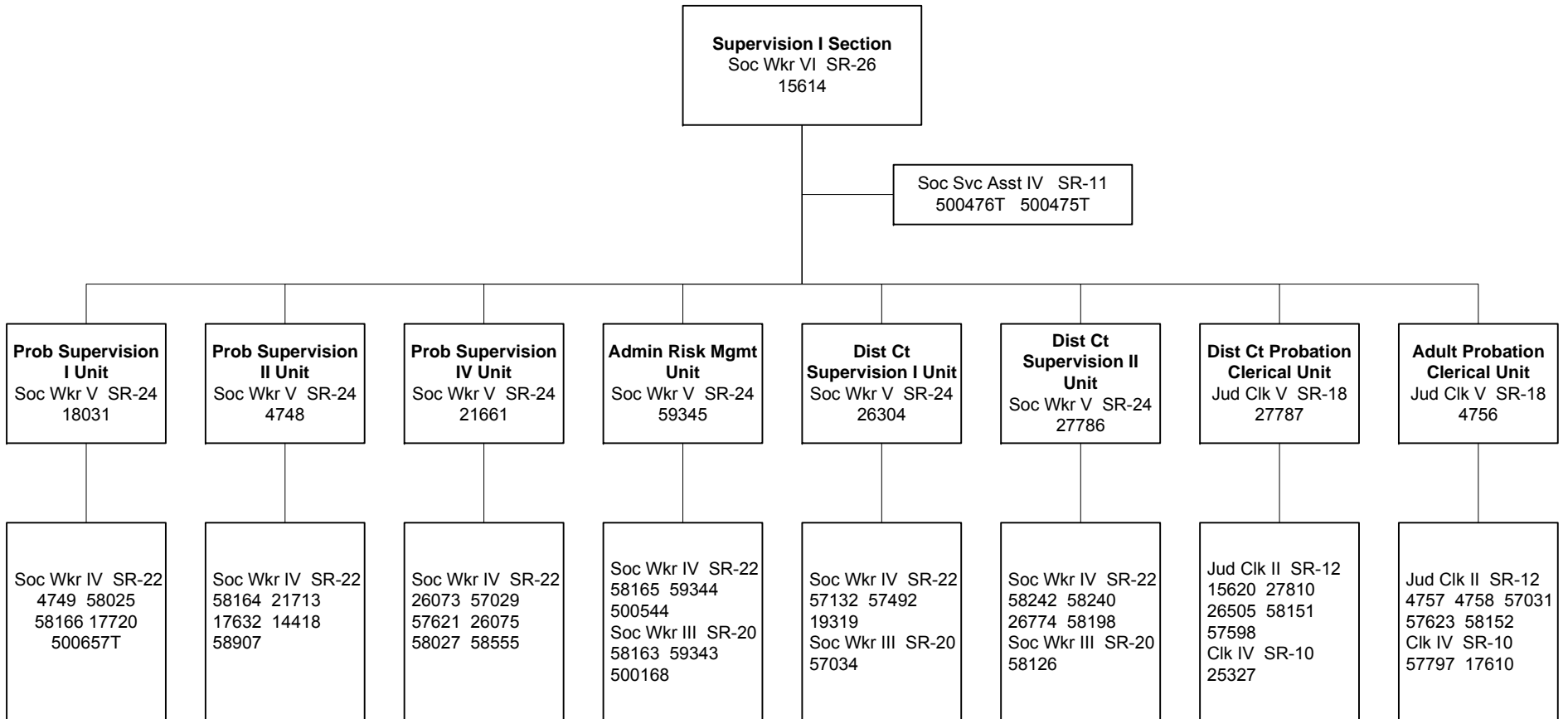

First Circuit

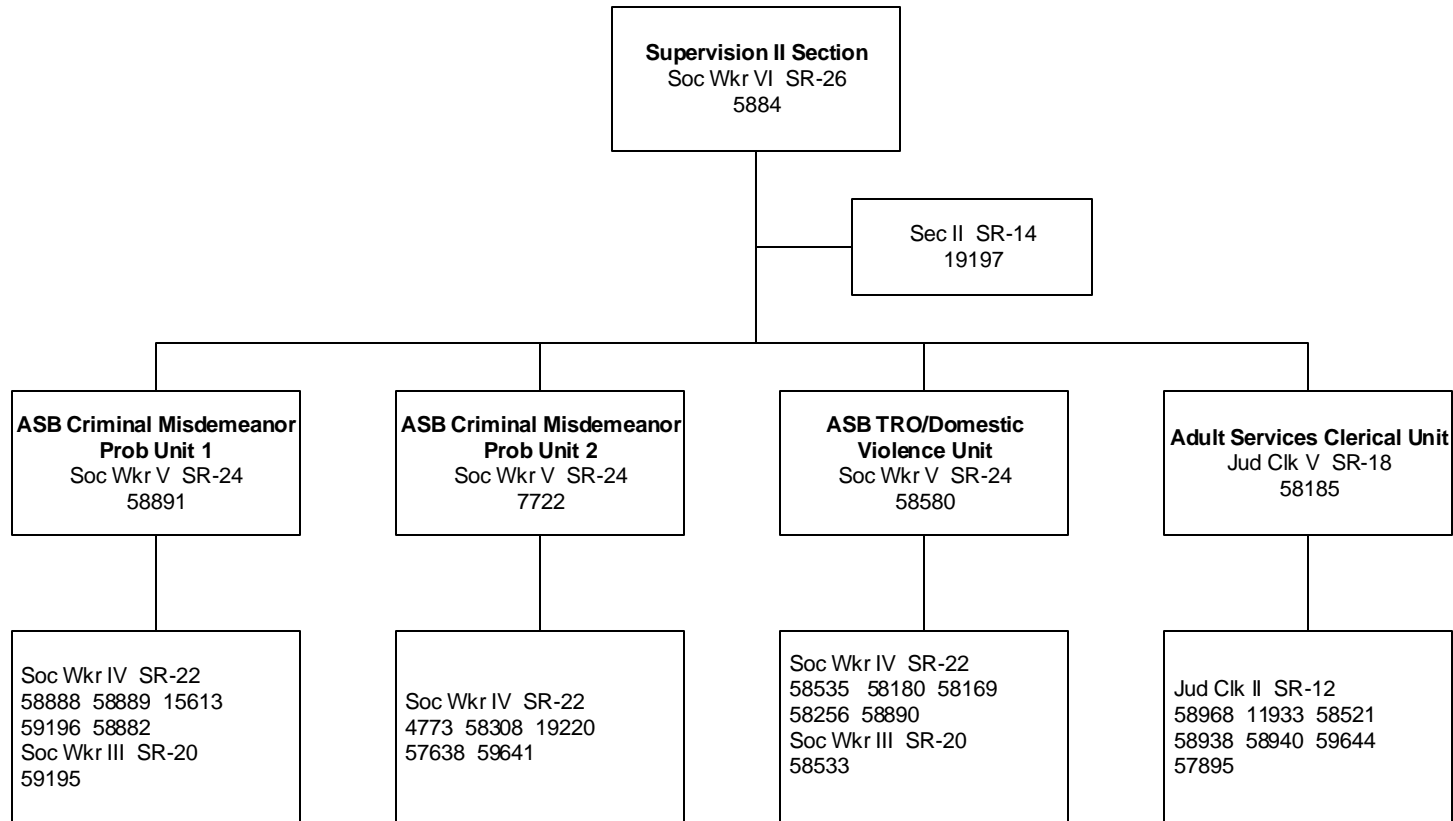

First Circuit

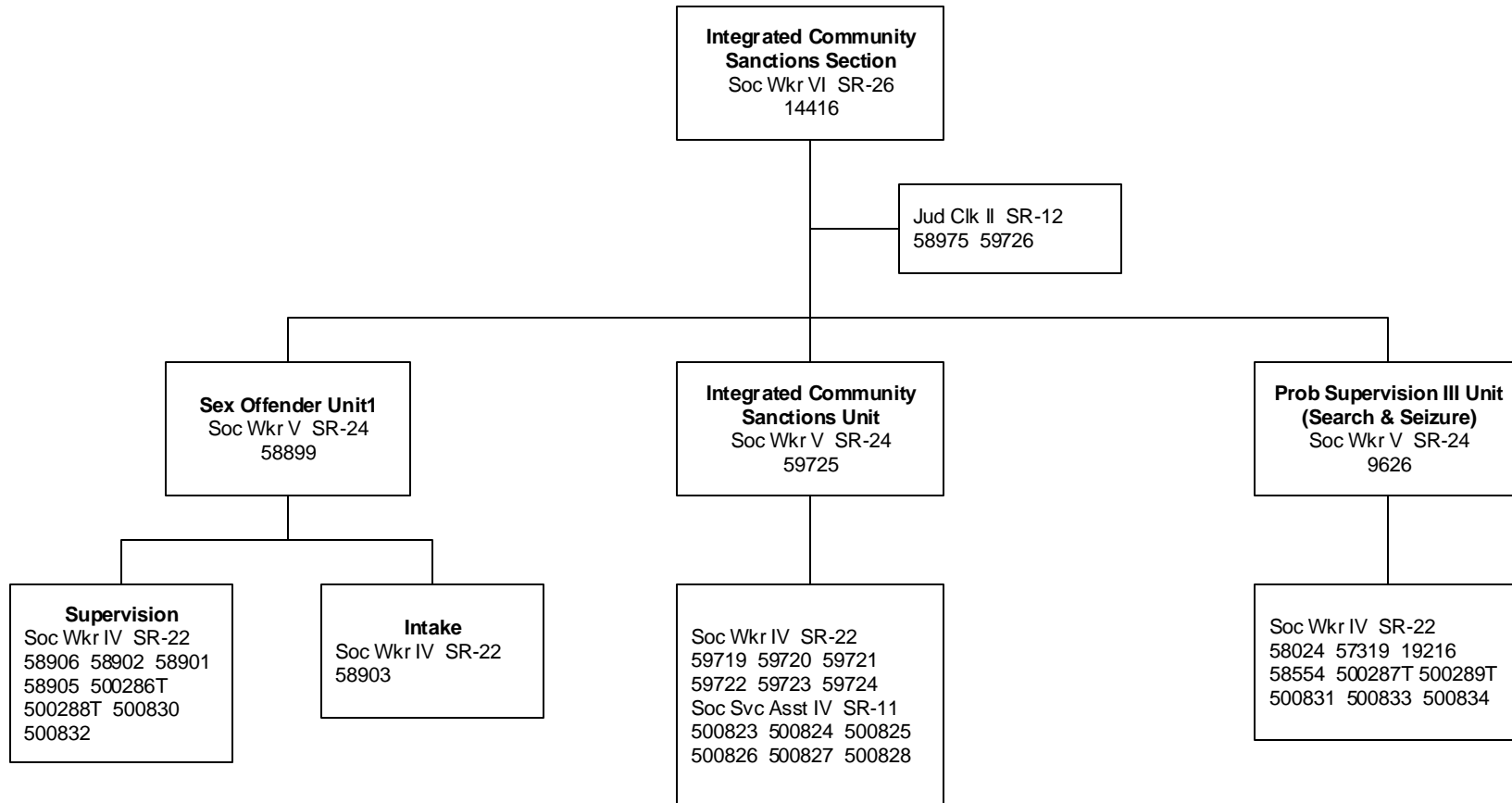

Estab perm Soc Svcs Asst IV psns 500823 – 500828 authorized by Act 26, SLH2018

Estab perm Soc Wkr IV psn 500830- 500834-authorized by Act 26, SLH2018

Updated October 2018

First Circuit

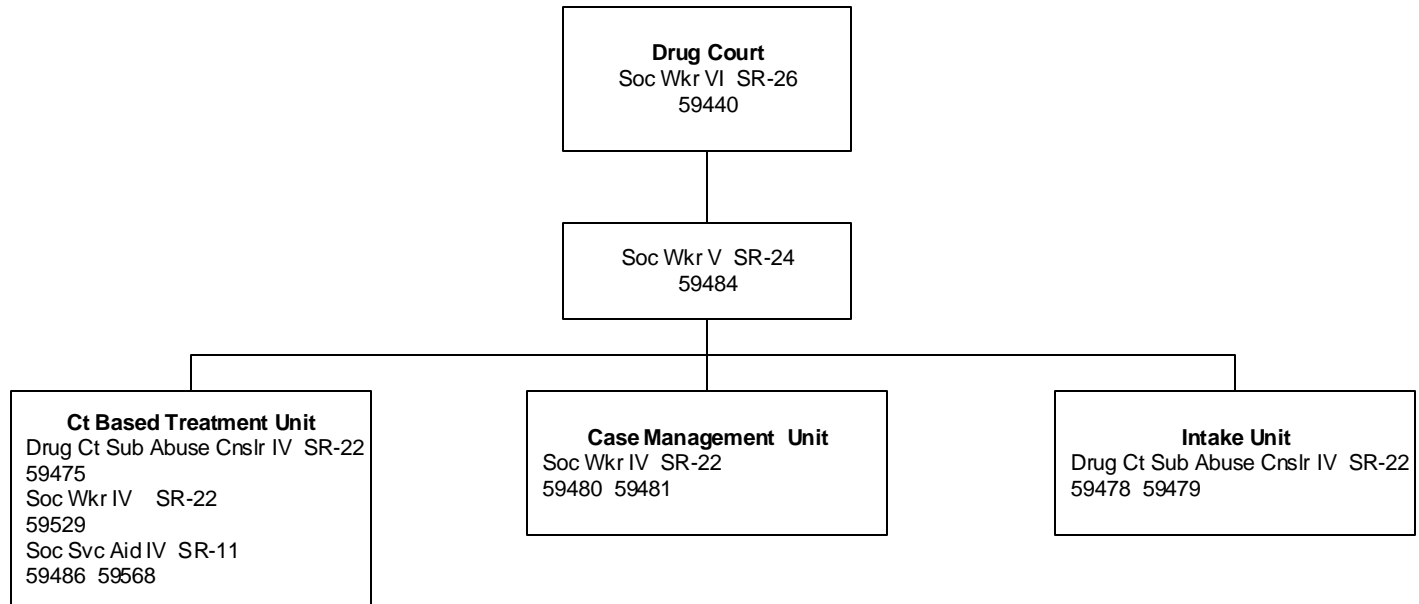

First Circuit

Client Services Division
 Adult Client Services Branch
 Specialized Services

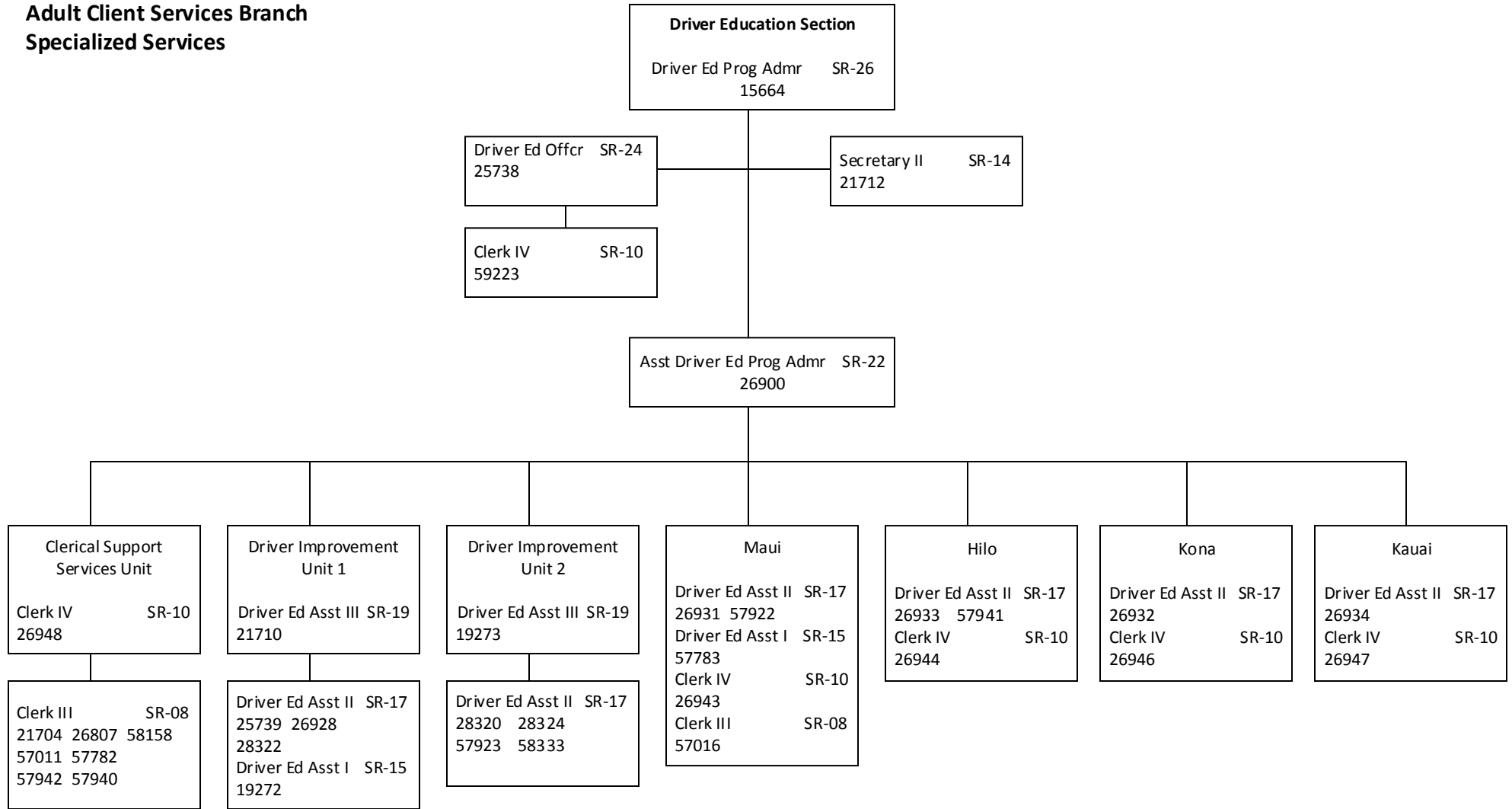

First Circuit

Client Services Division
Juvenile Client Services Branch

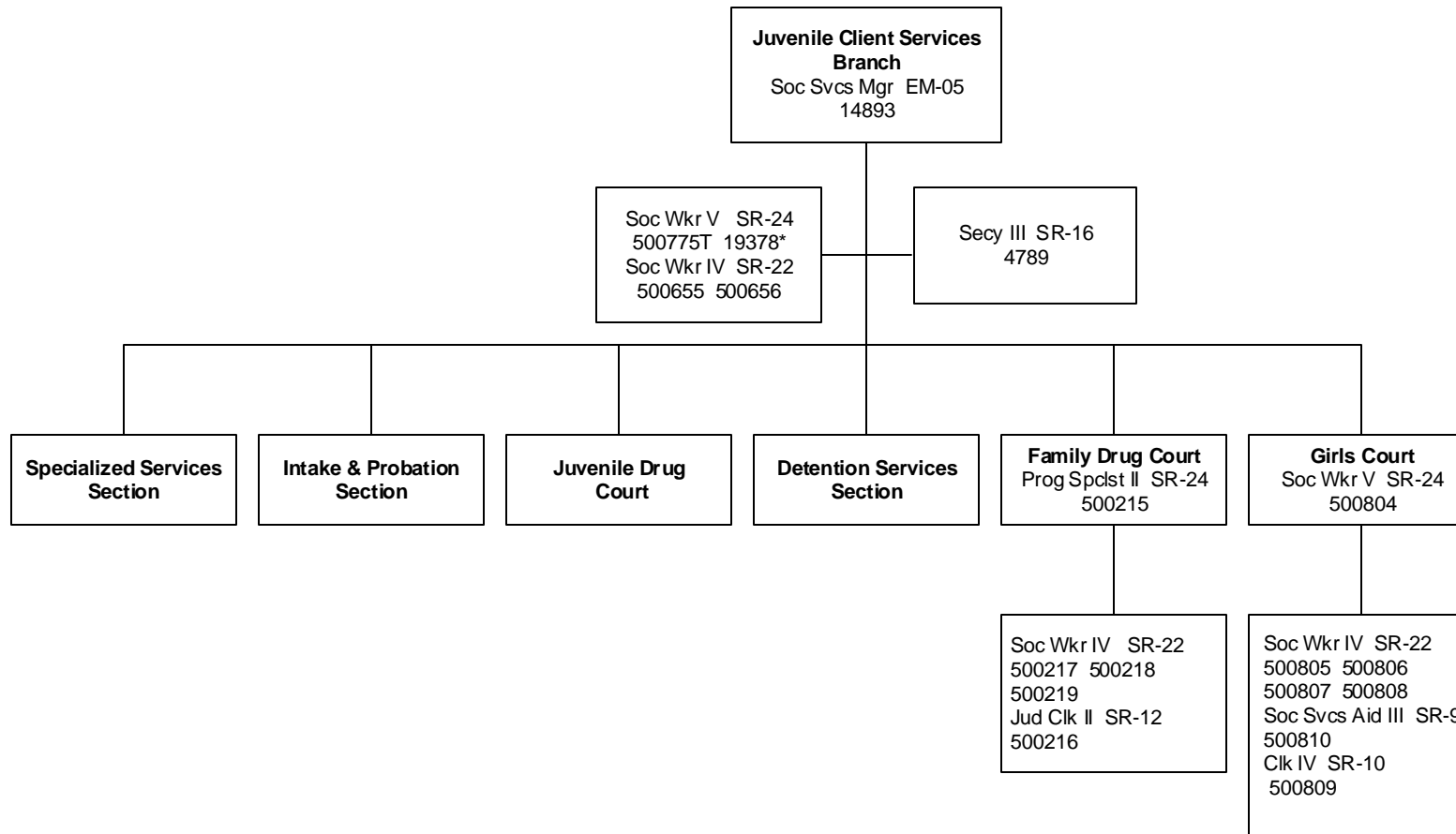

*Position No. 19378 SW V transferred from CCA SW Prog-Kapolei

First Circuit

Client Services Division
 Juvenile Client Services Branch

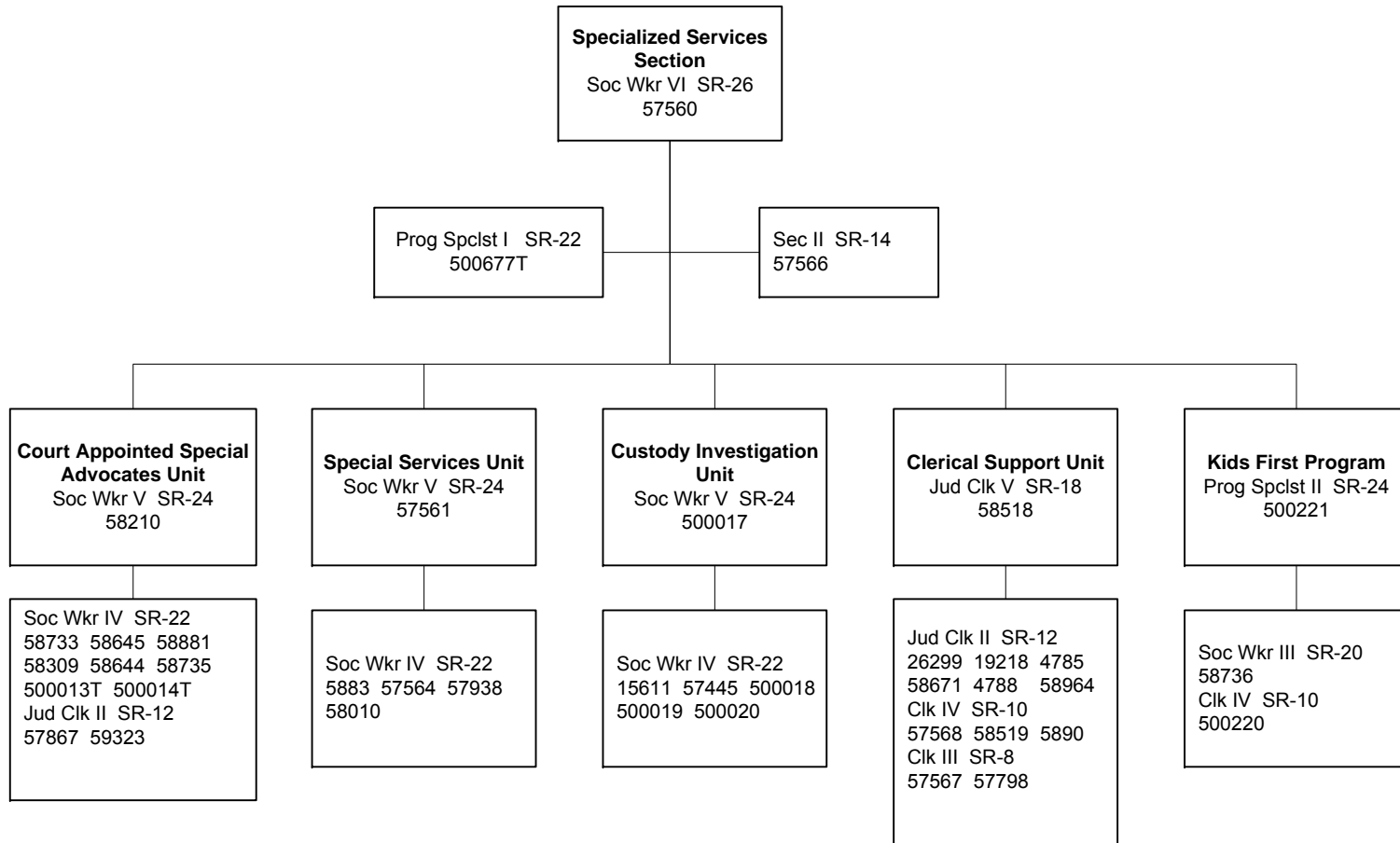

First Circuit

Client Services Division
 Juvenile Client Services Branch

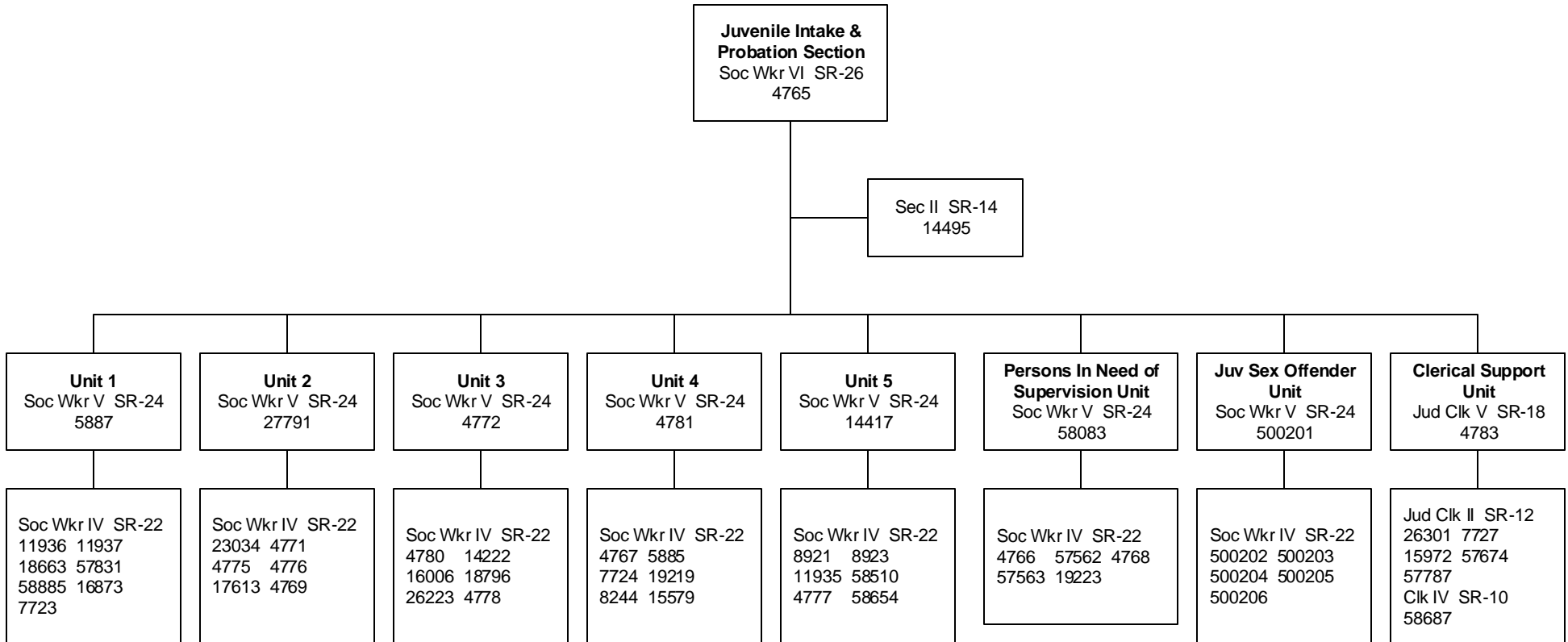

First Circuit

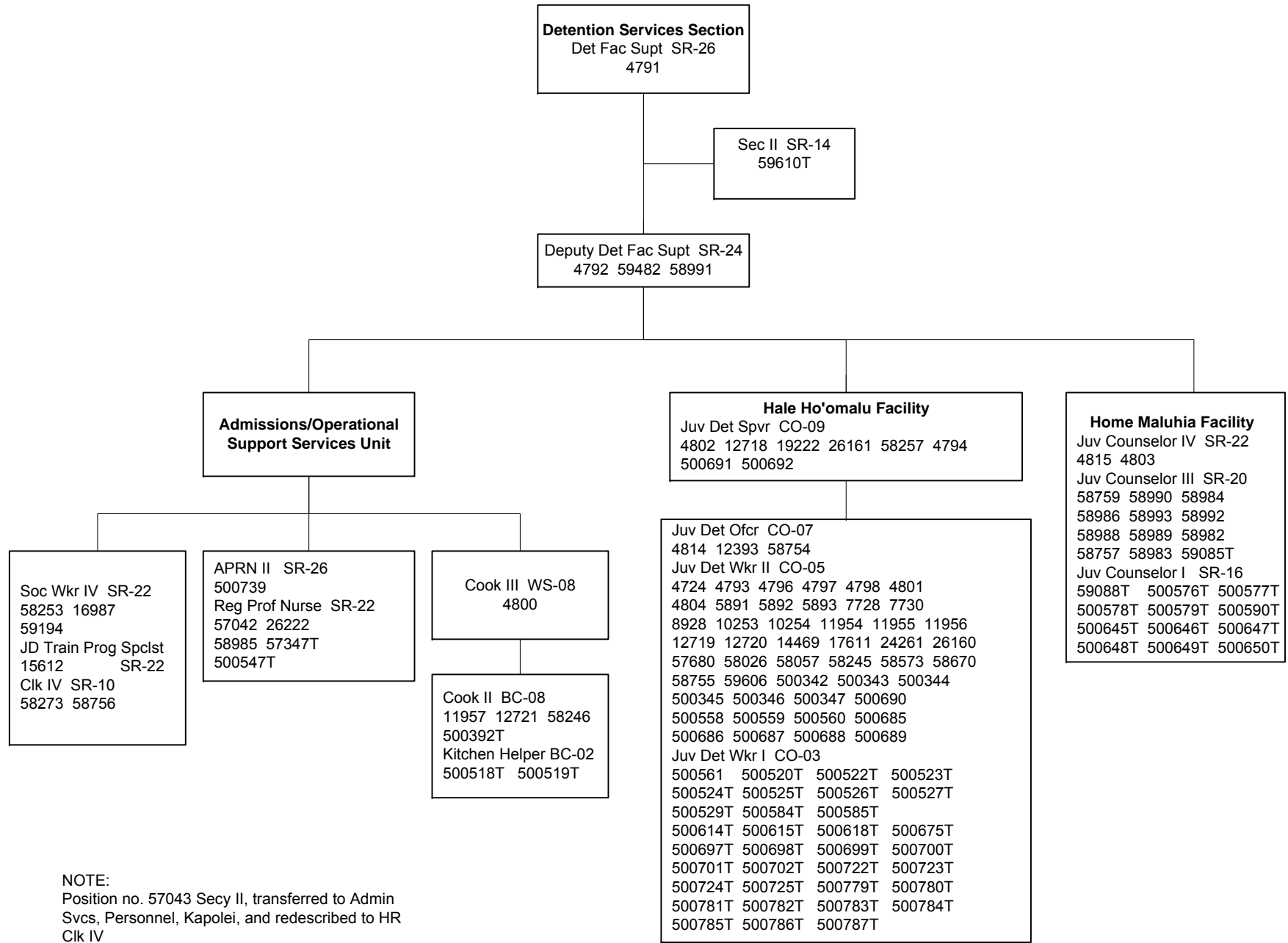

NOTE:
Position no. 57043 Secy II, transferred to Admin Svcs, Personnel, Kapolei, and redescribed to HR Clk IV

500531T JDW I, trfr to 15th Div & realloc to Law Clk

First Circuit

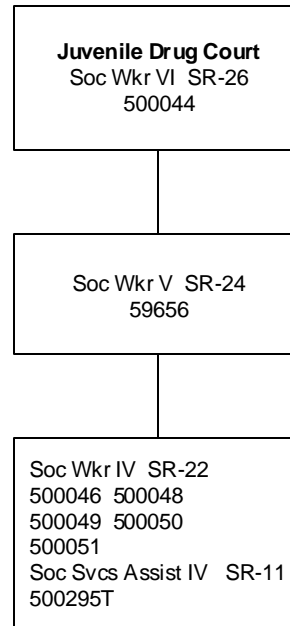

First Circuit

Court Services Division

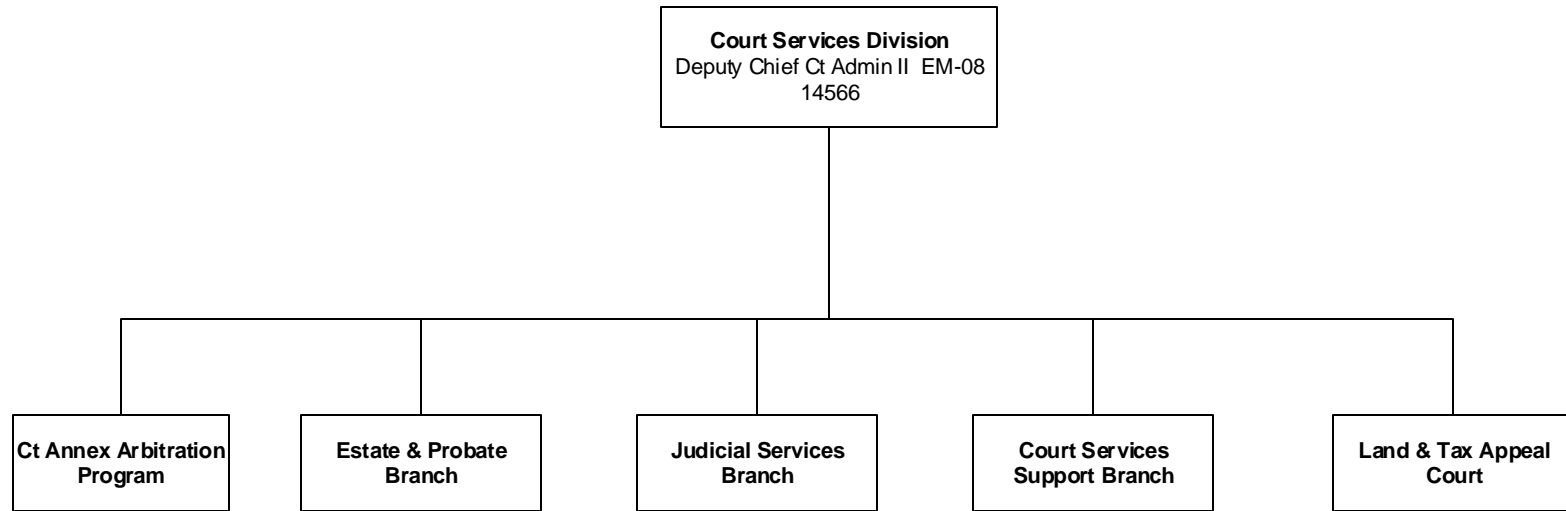

Updated December 2017

First Circuit

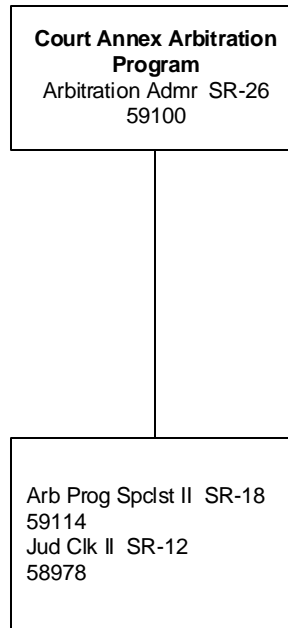

First Circuit

Court Services Division
Court Services Support Branch

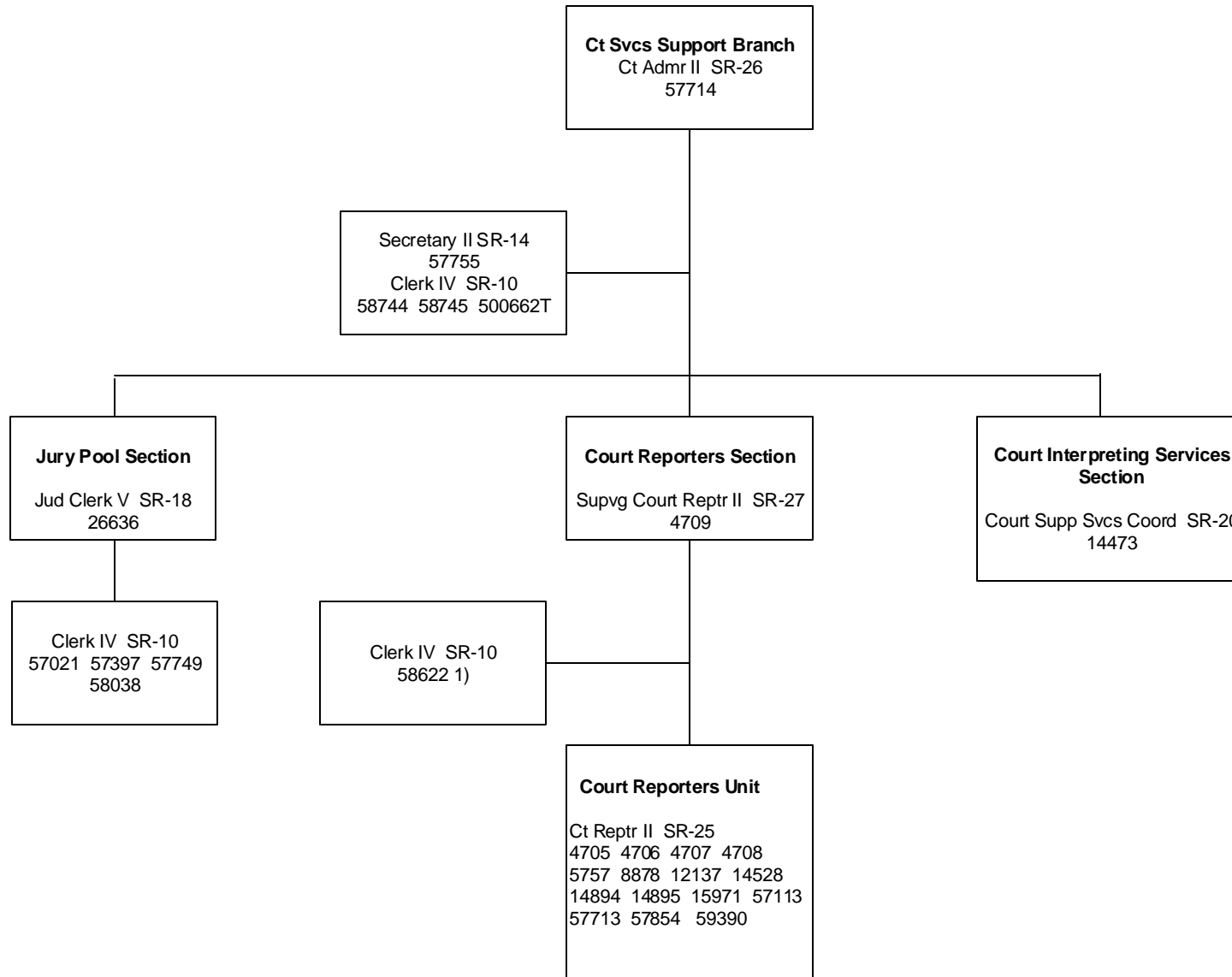

1) Provides clerical support to the Certified Shorthand Reporters Board

First Circuit

Estate & Probate

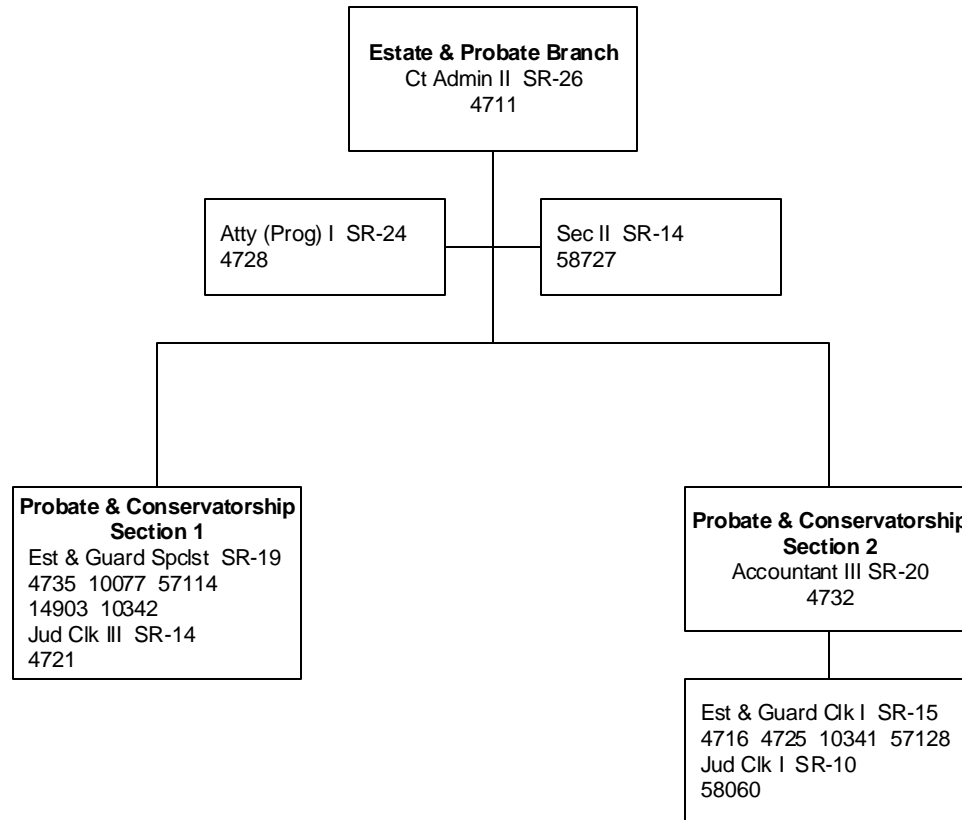

Updated December 2017

First Circuit

Court Services Division
Judicial Services Branch

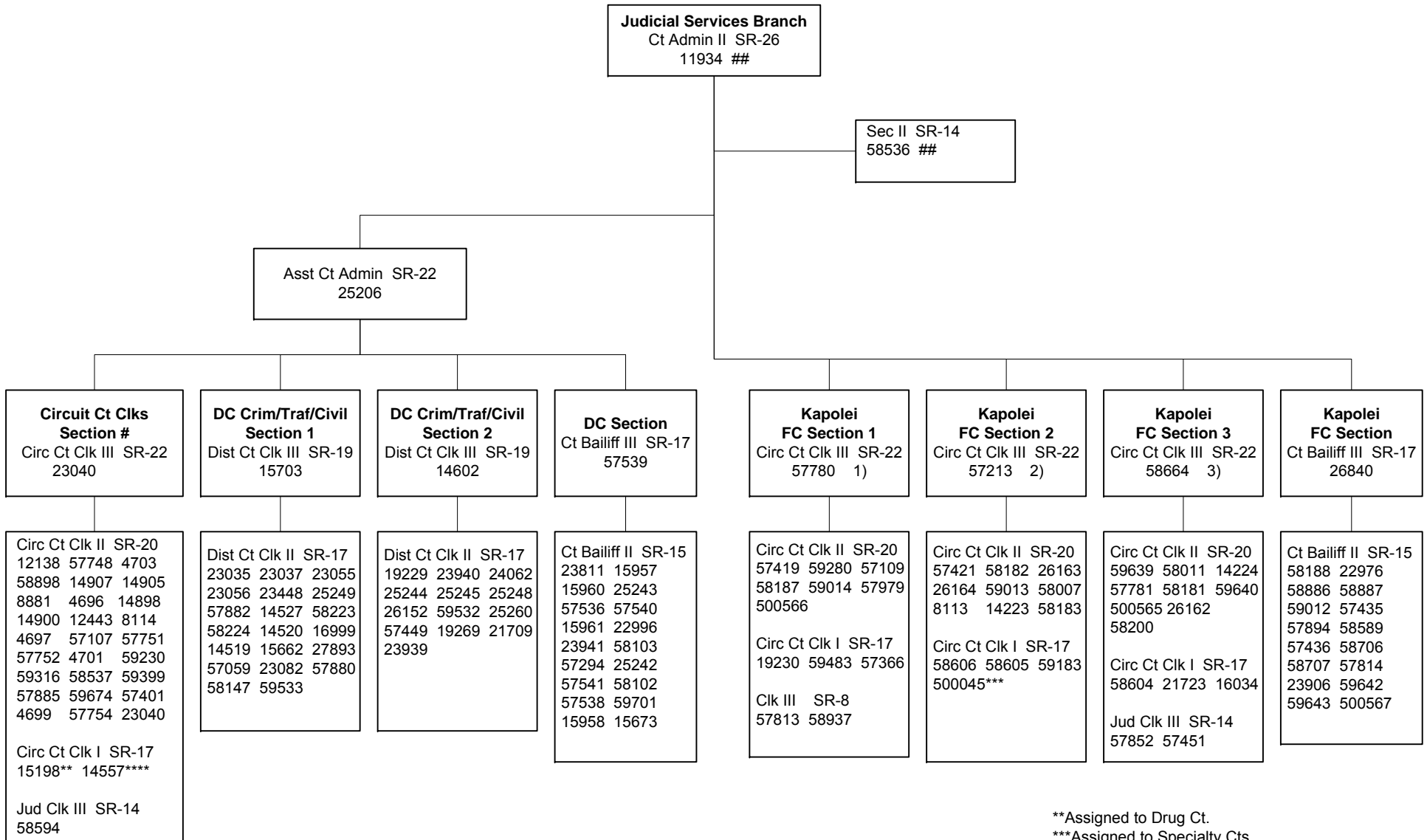

**Assigned to Drug Ct.
***Assigned to Specialty Cts.
****Assigned to HOPE.

Circ Ct Clk positions from the Trial Divisions and former Criminal Administration will be administratively assigned to individual trial divisions
position located at Kapolei

- 1) Domestic Calendar
- 2) Juvenile Calendar
- 3) Special Calendar

Updated August 2018

First Circuit

Court Services Division
Land & Tax Appeal Court

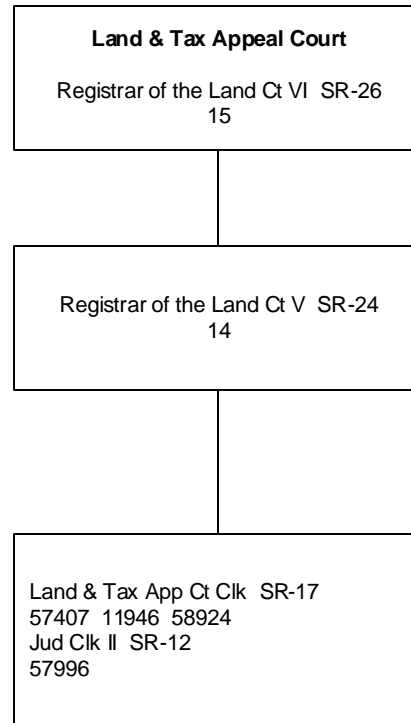

First Judicial Circuit

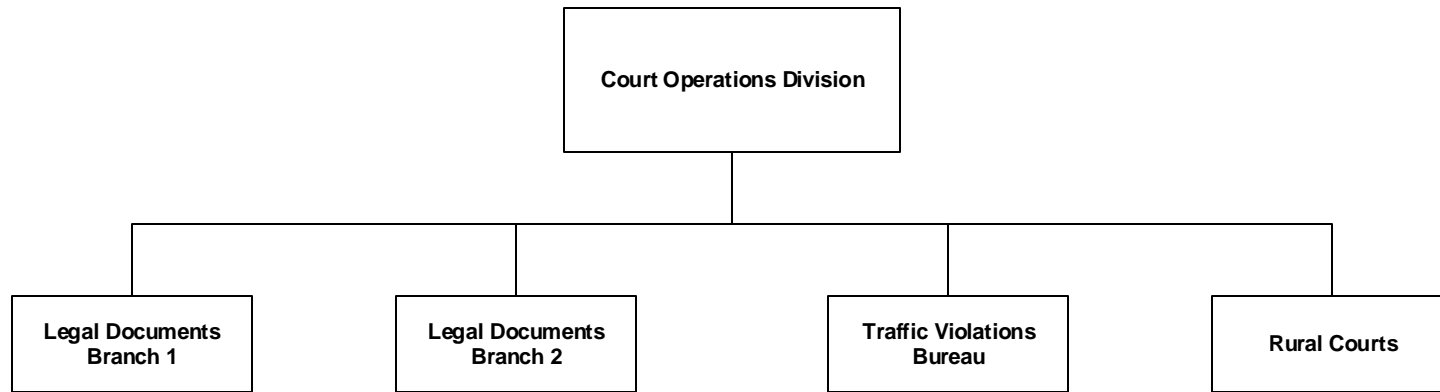

First Circuit

Court Operations Division

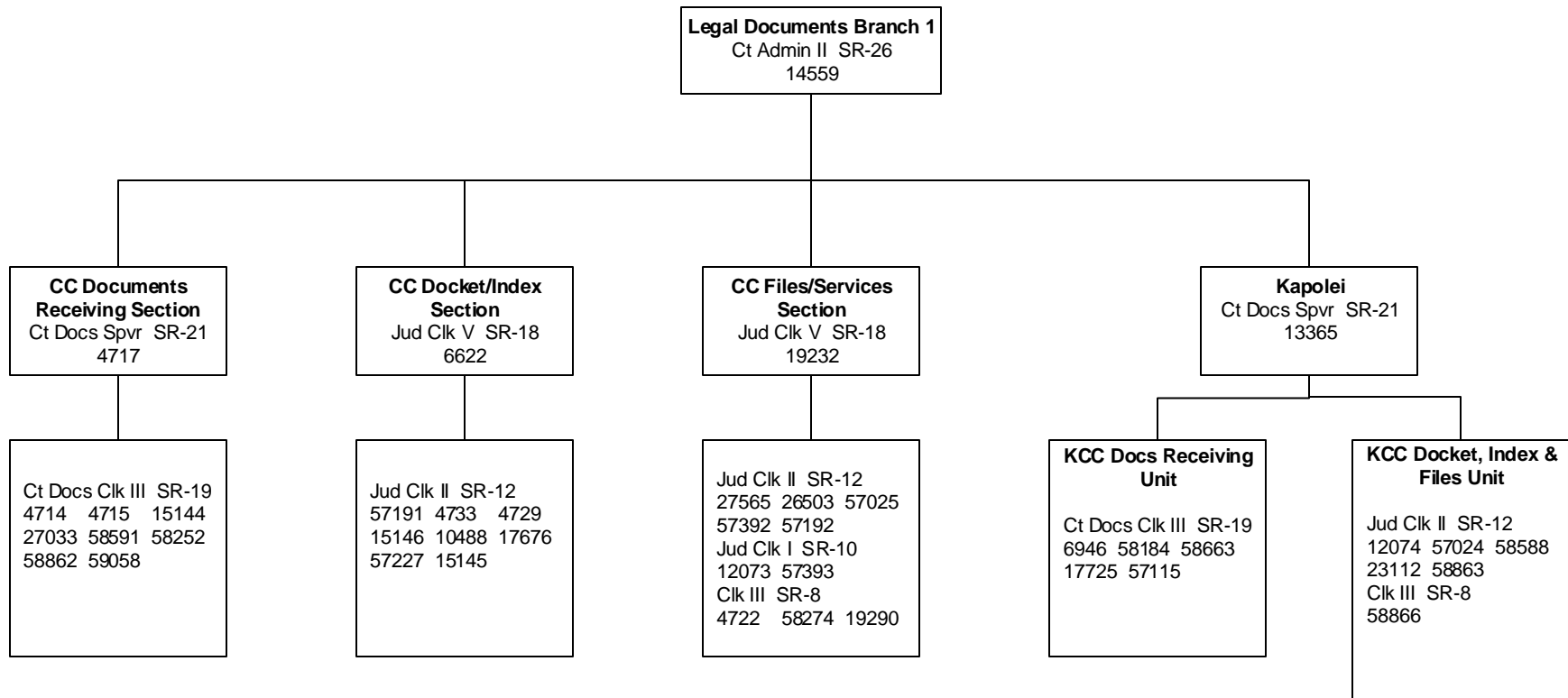

First Circuit

Court Operations Division

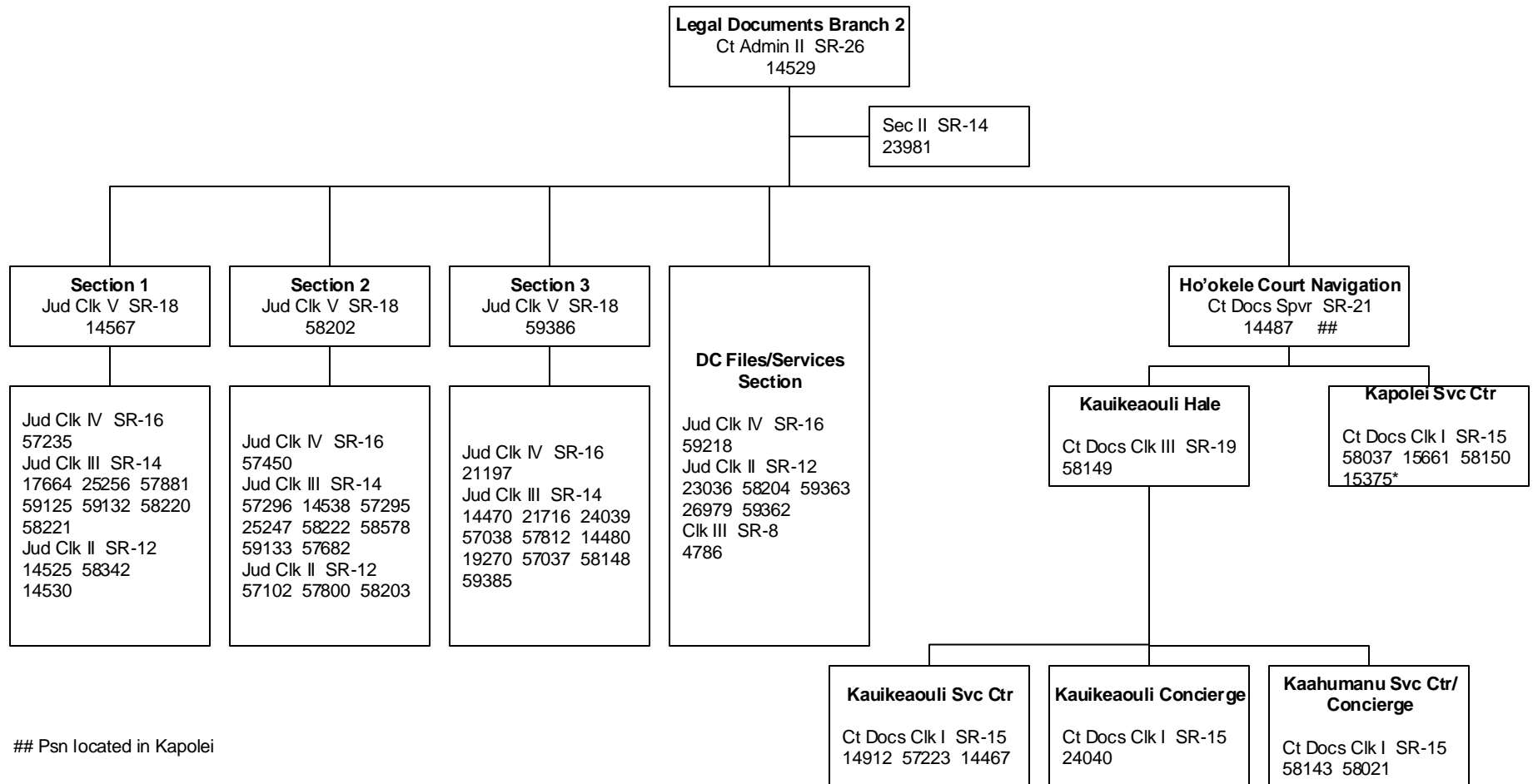

Psn located in Kapolei

*Position No. 15375 transferred from DC Files/Svcs to Kapolei Svc Ctr.

First Circuit

COURT OPERATIONS DIVISION
Traffic Violations Bureau

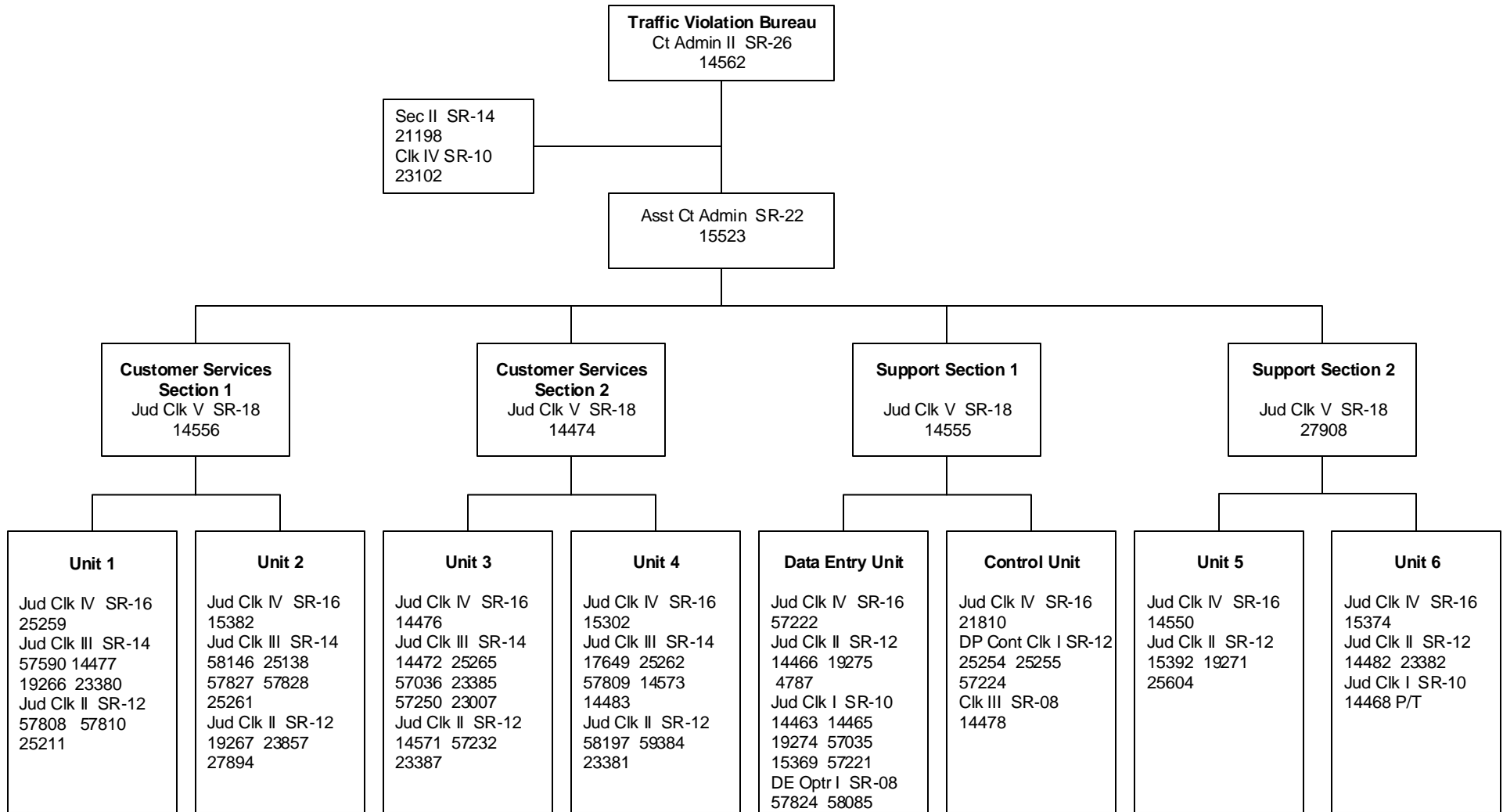

First Circuit

COURT OPERATIONS DIVISION
RURAL COURTS
Koolauloa/Koolaupoko

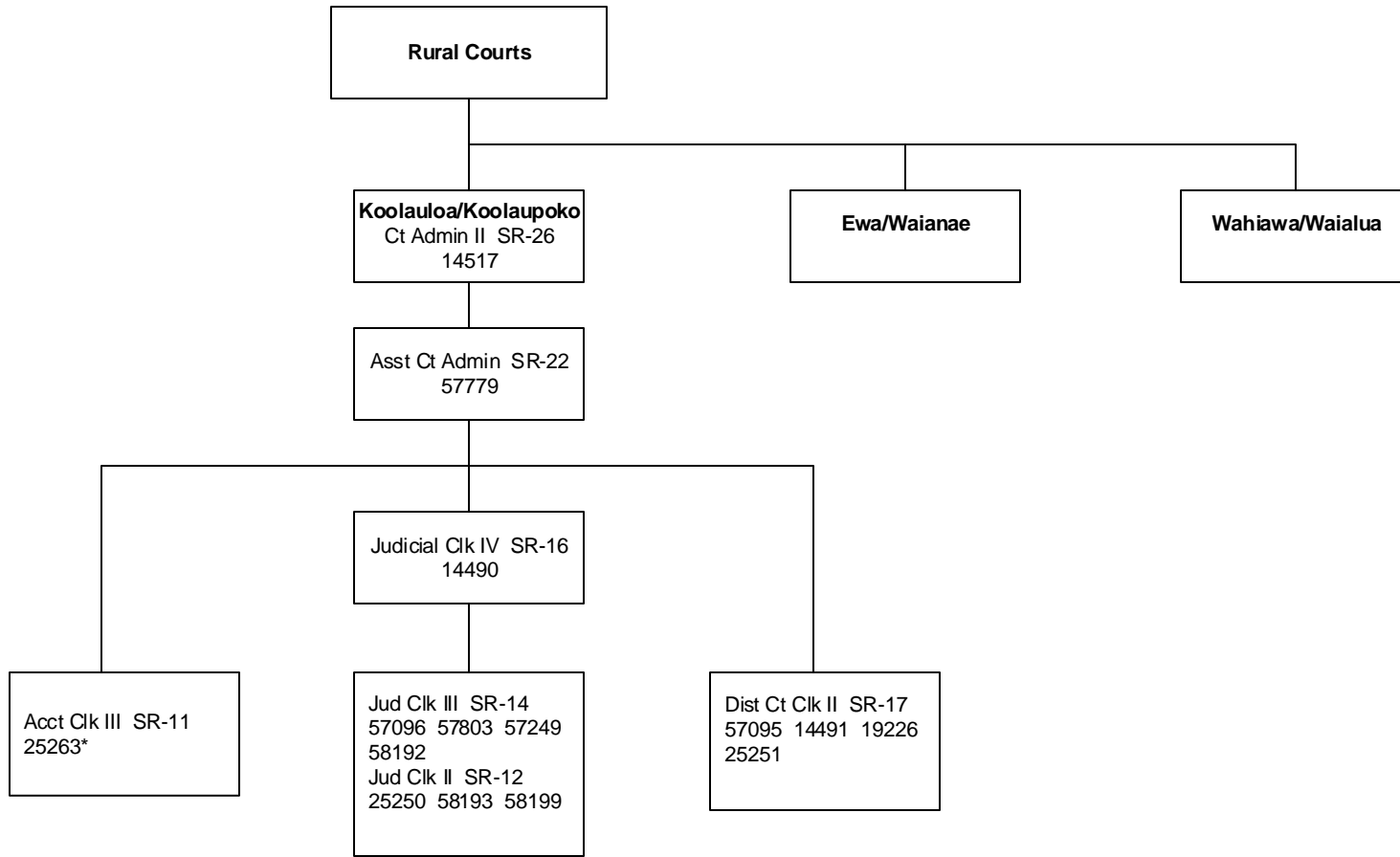

*Position provides account clerical services for Kaneohe and Wahiawa.

First Circuit

COURT OPERATIONS DIVISION
RURAL COURTS
Ewa/Waianae

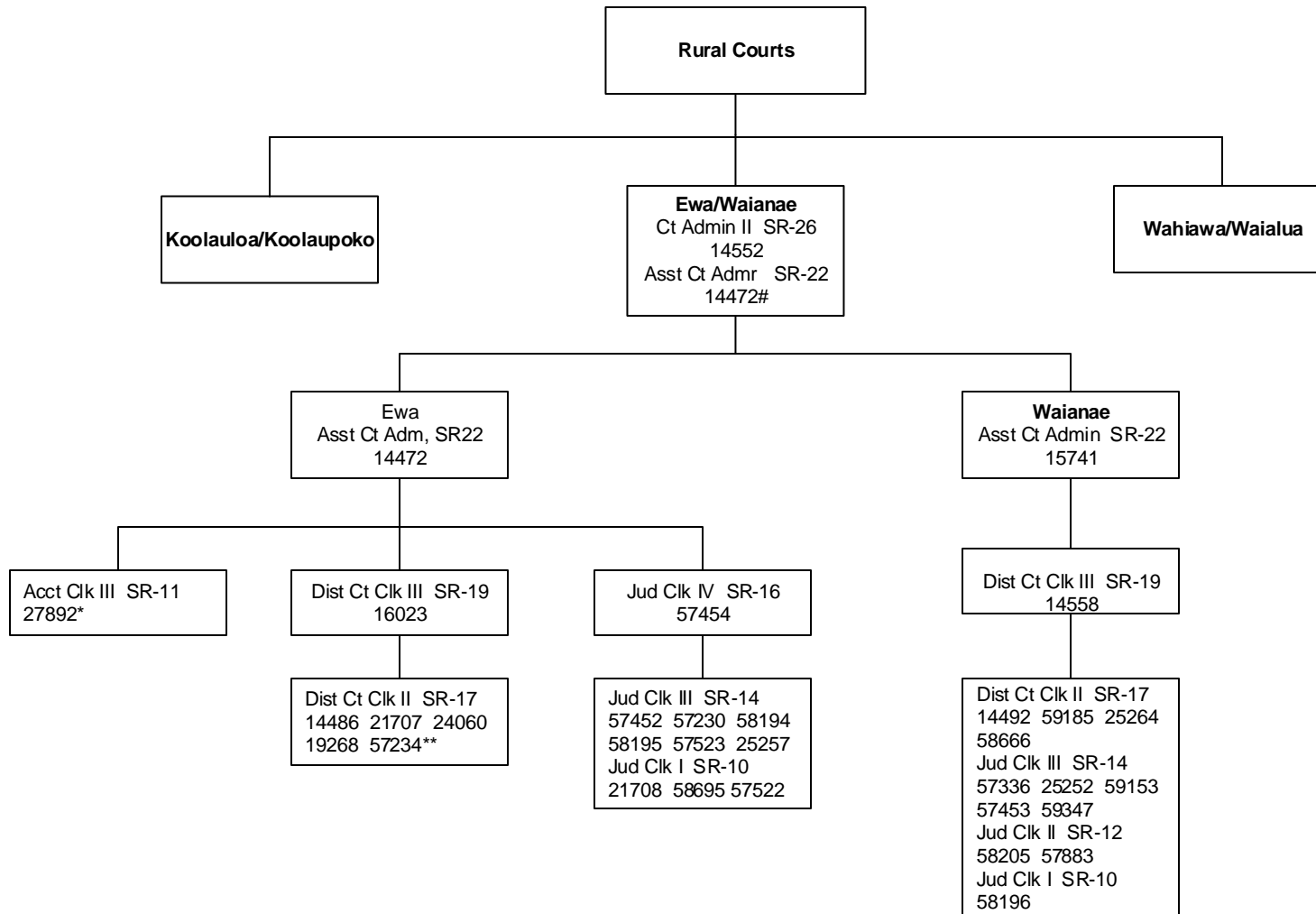

*Position provides account clerical services for Ewa and Waianae.

**Position also provides courtroom clerical for Ewa and Waianae.

First Circuit

COURT OPERATIONS DIVISION
RURAL COURTS
Wahiawa/Waiialua

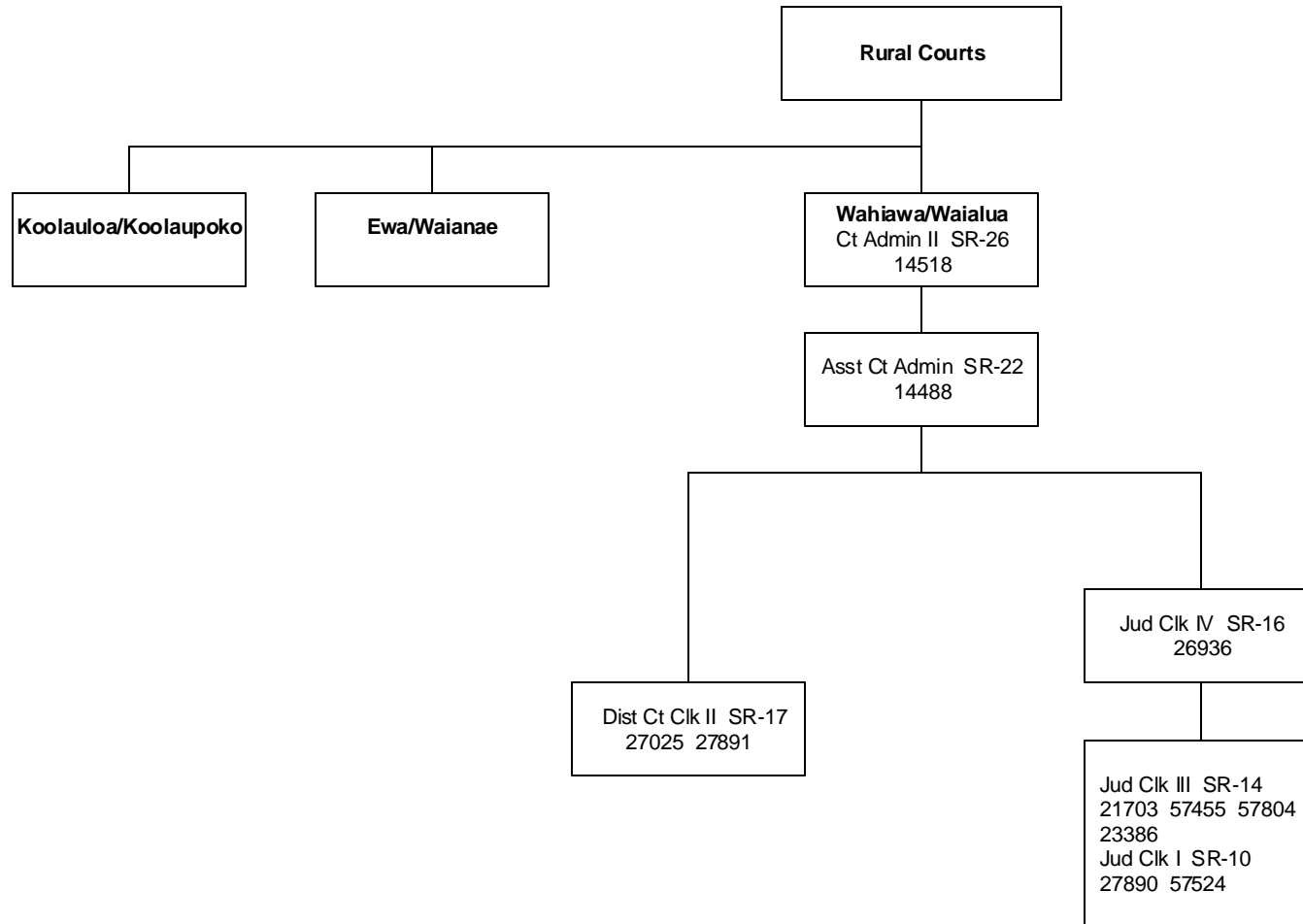

SECOND JUDICIAL CIRCUIT

Circuit Judges

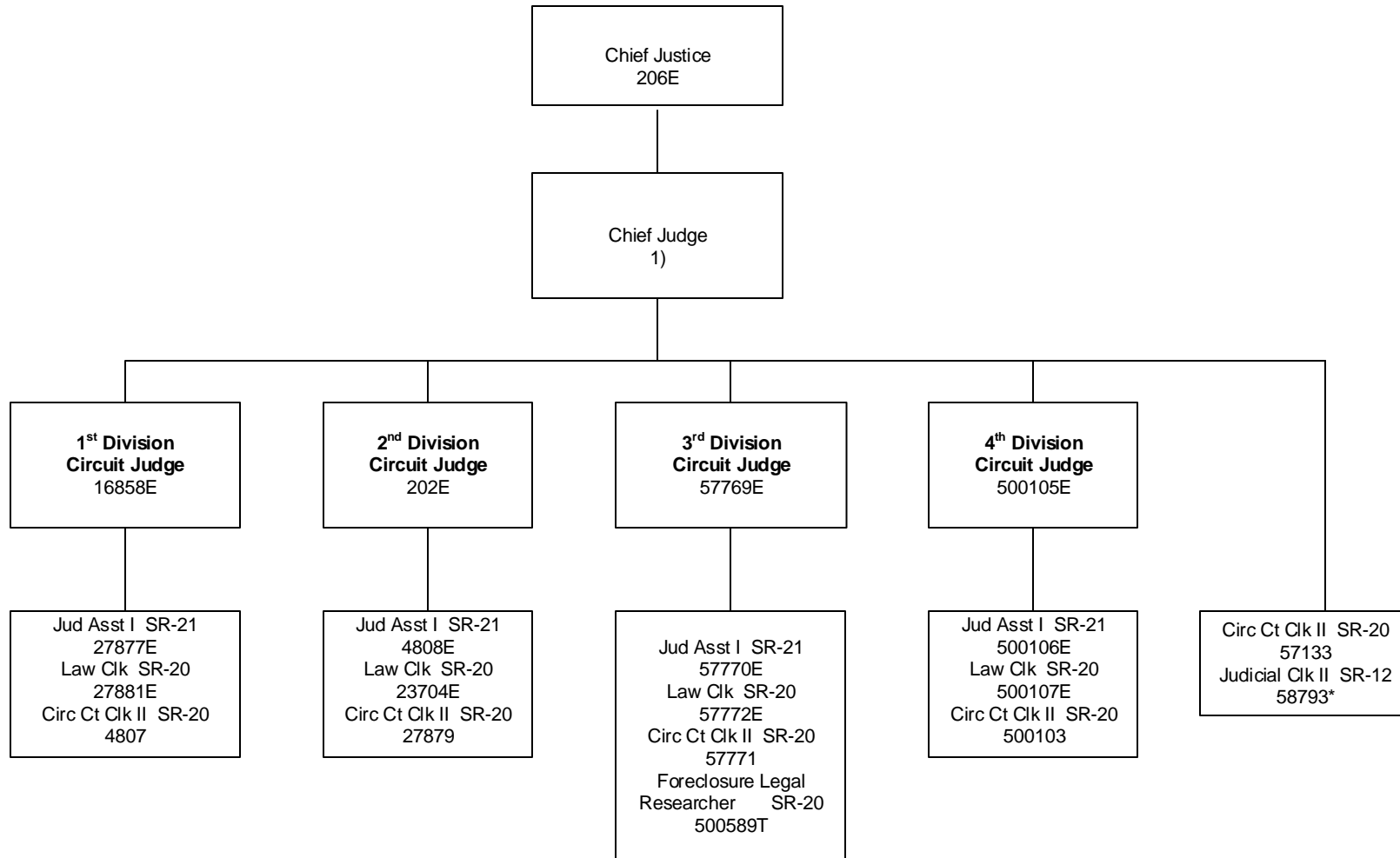

*Position No. 58793 transferred from Ct & Ops Supt Svcs, Legal Docs and redescribed

1) Per Chief Justice's order of appointment.

SECOND JUDICIAL CIRCUIT

District Judges

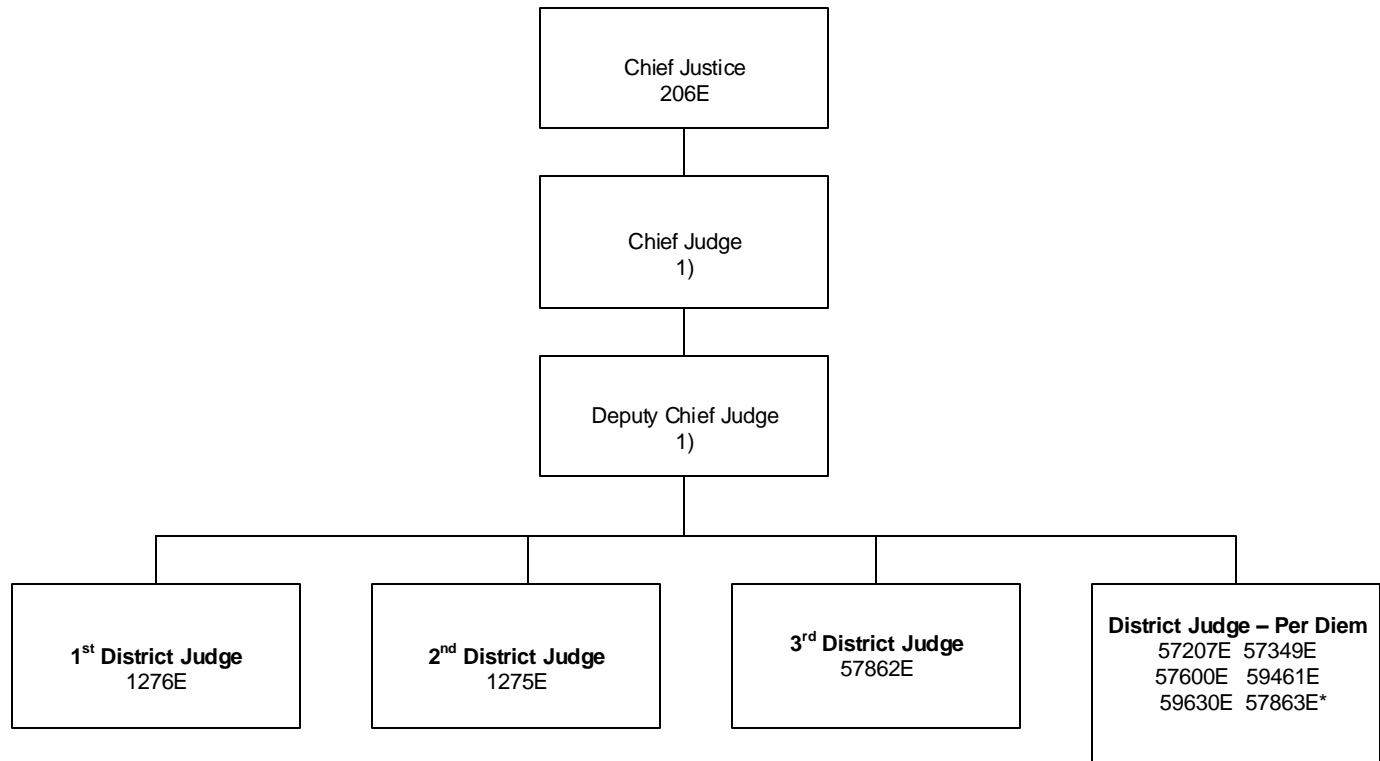

1) Per Chief Justice's order of appointment.

*Assigned to Molokai.

SECOND JUDICIAL CIRCUIT

Family Judges

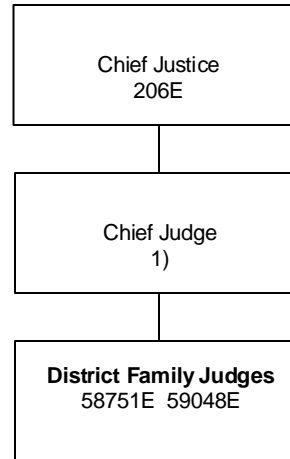

1) Per Chief Justice's order of appointment.

SECOND CIRCUIT

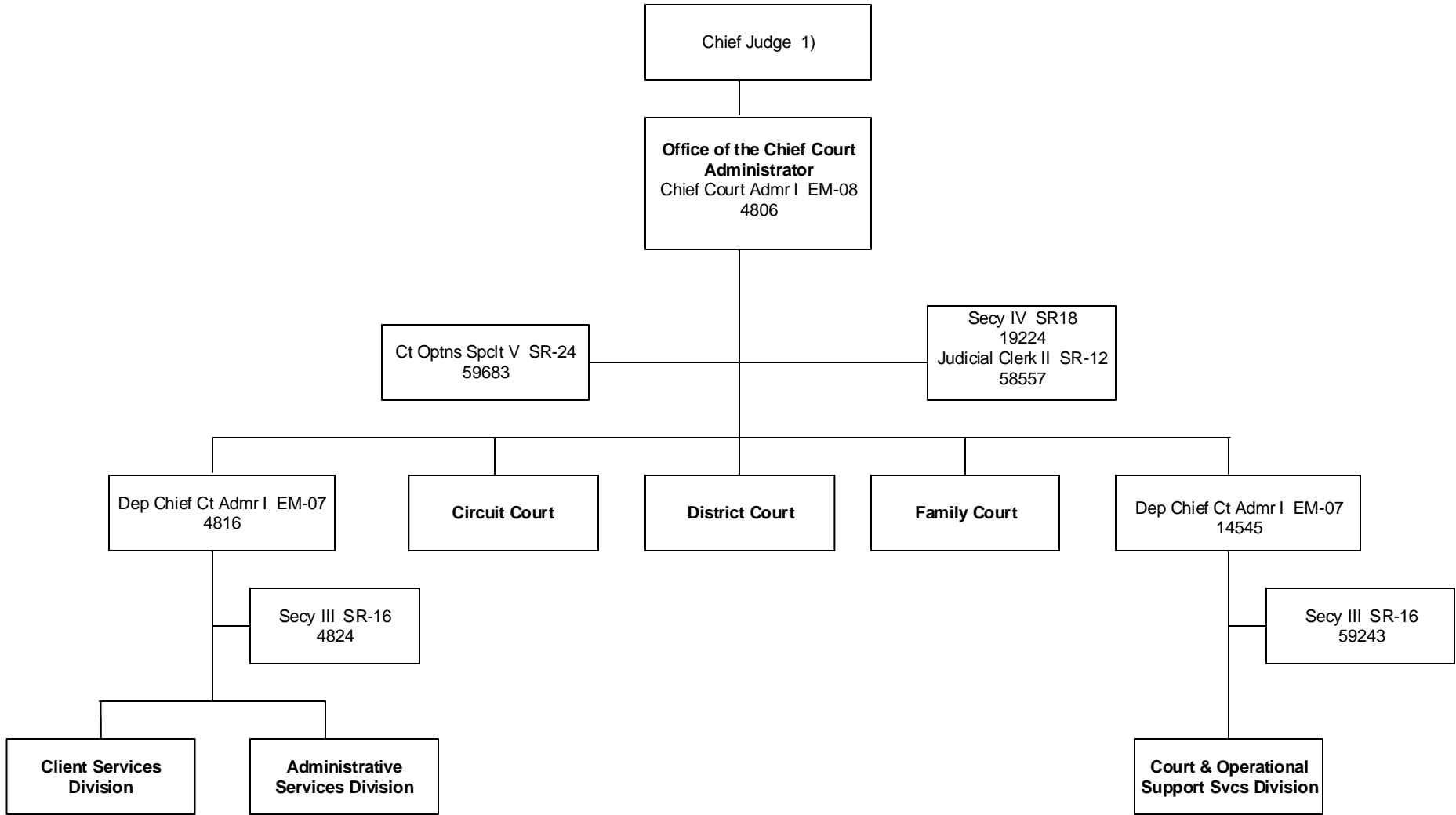

1) Per Chief Justice's order of appointment.

SECOND CIRCUIT

Administrative Services Division

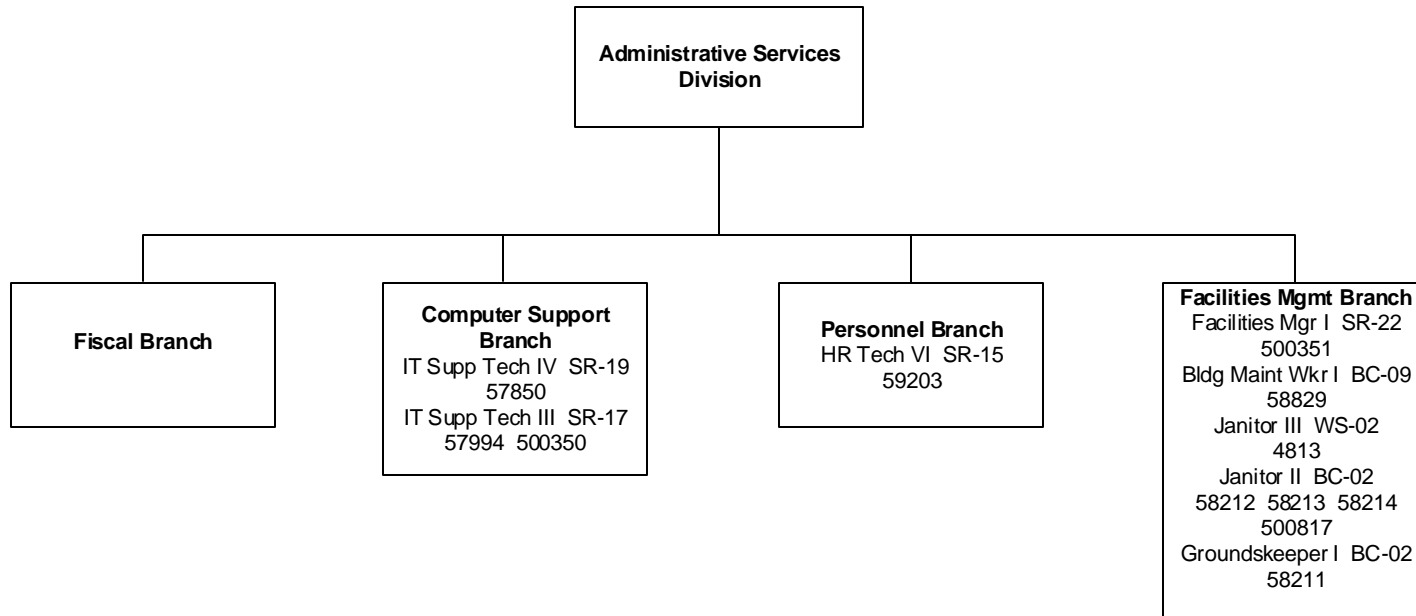

Estab half time Janitor II 500817 authorized by Act 26, SLH2018

Updated September 2018

Second Circuit

Fiscal Branch

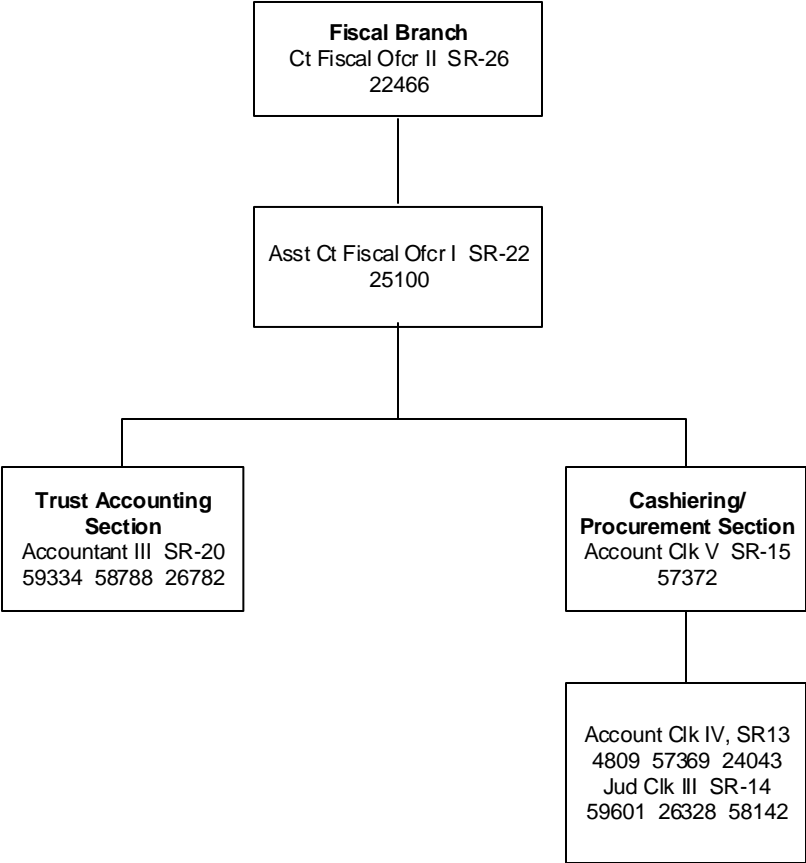

Second Circuit

Client Services Division

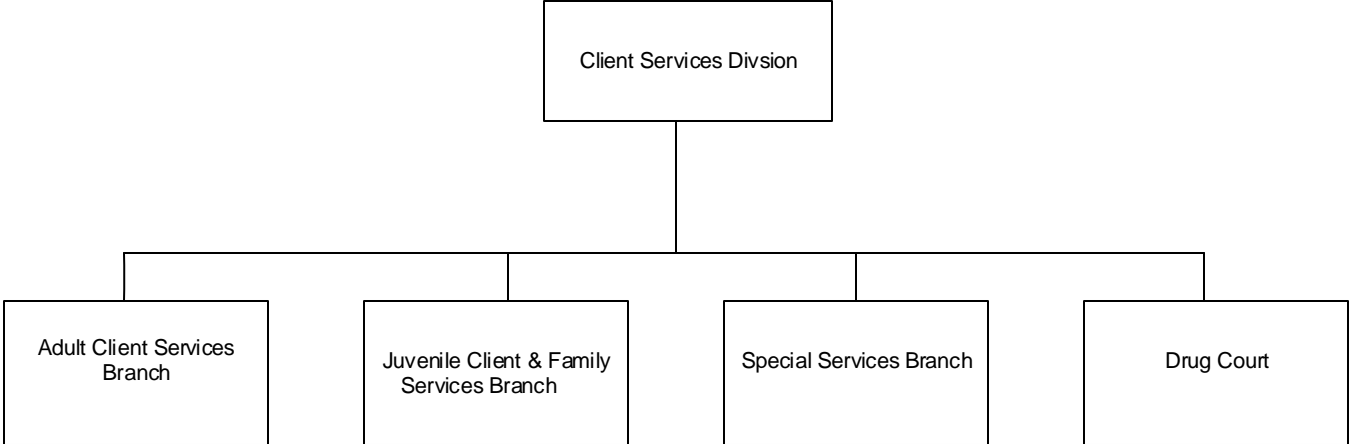

SECOND CIRCUIT

Client Services Division
Adult Client Services Branch

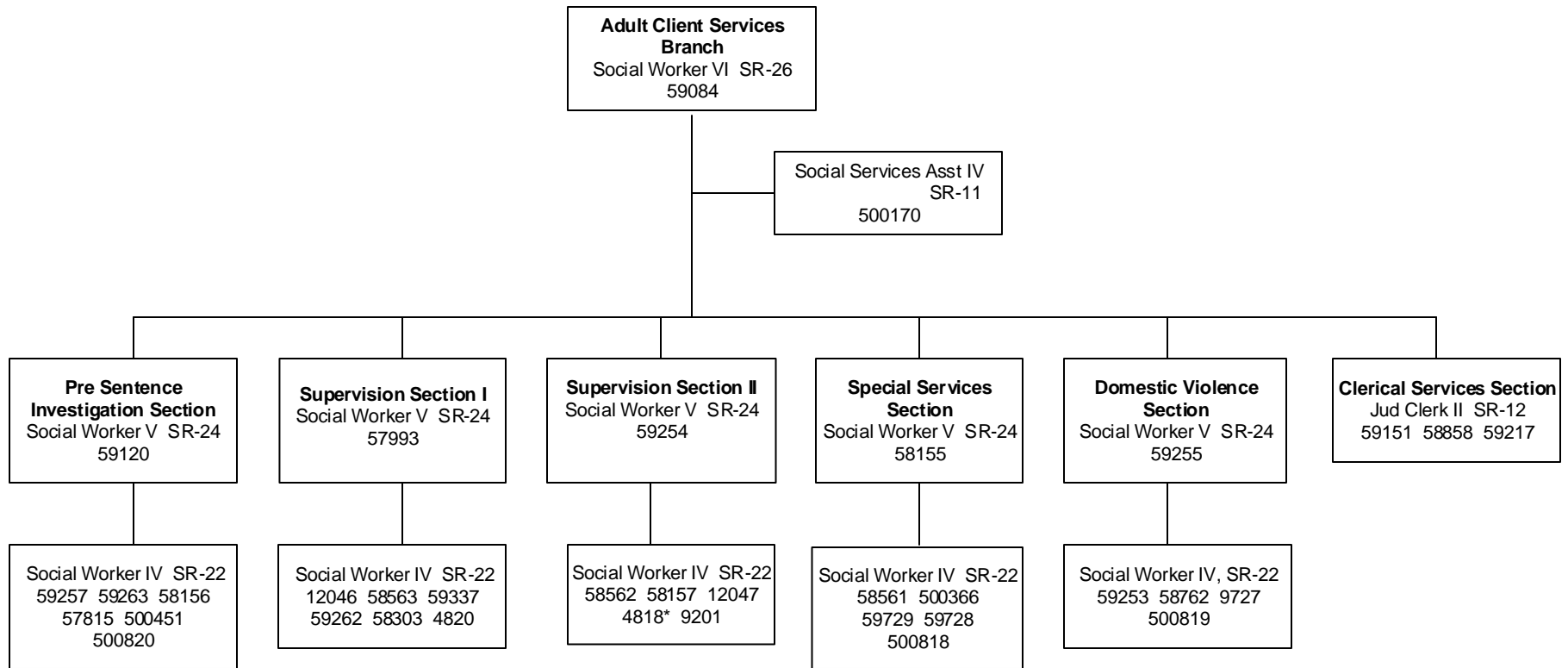

* Position is physically located on the island of Molokai.

Estab perm Soc Wkr IV psn 500818, 500819, 500820
authorized by Act 26, SLH2018

Updated September 2018

SECOND CIRCUIT

Client Services Division
Juvenile Client & Family Services Branch

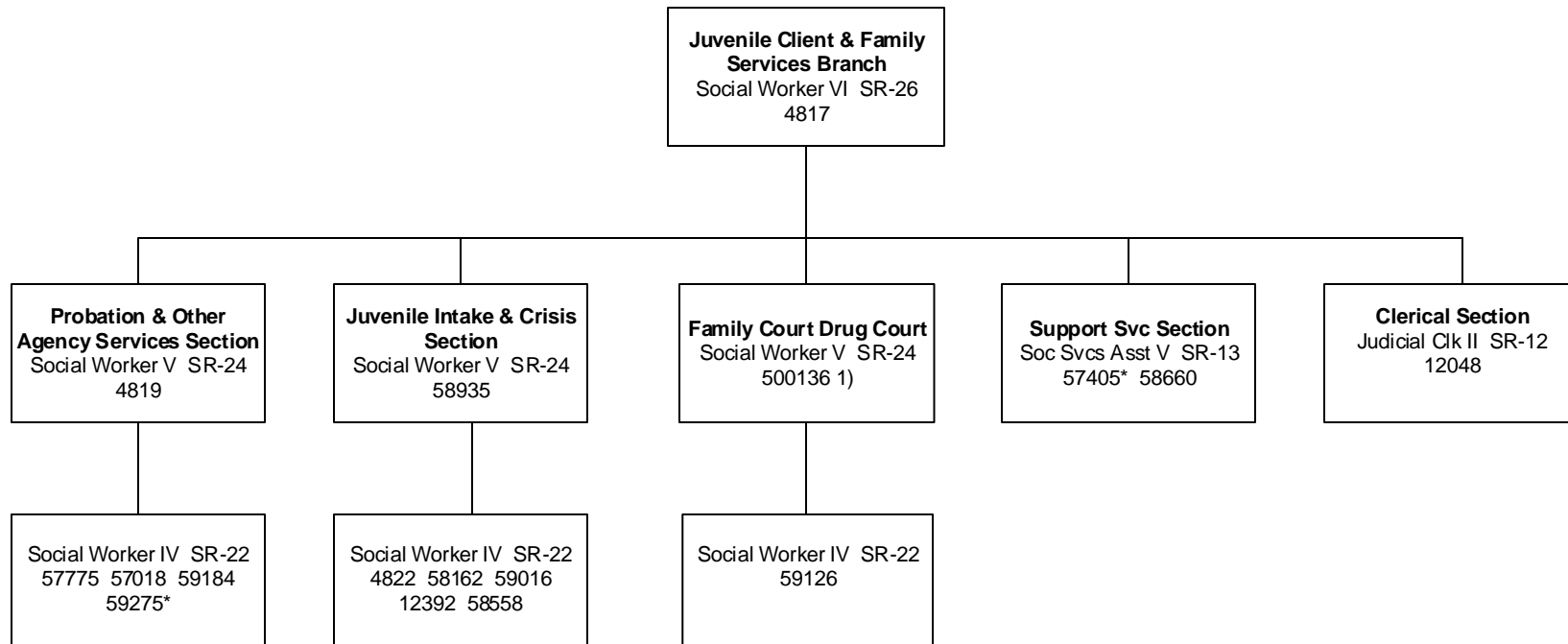

1) Position also serves as a social work program specialist.

*Position is physically located on the island of Molokai

SECOND CIRCUIT

Client Services Division
Special Services Branch

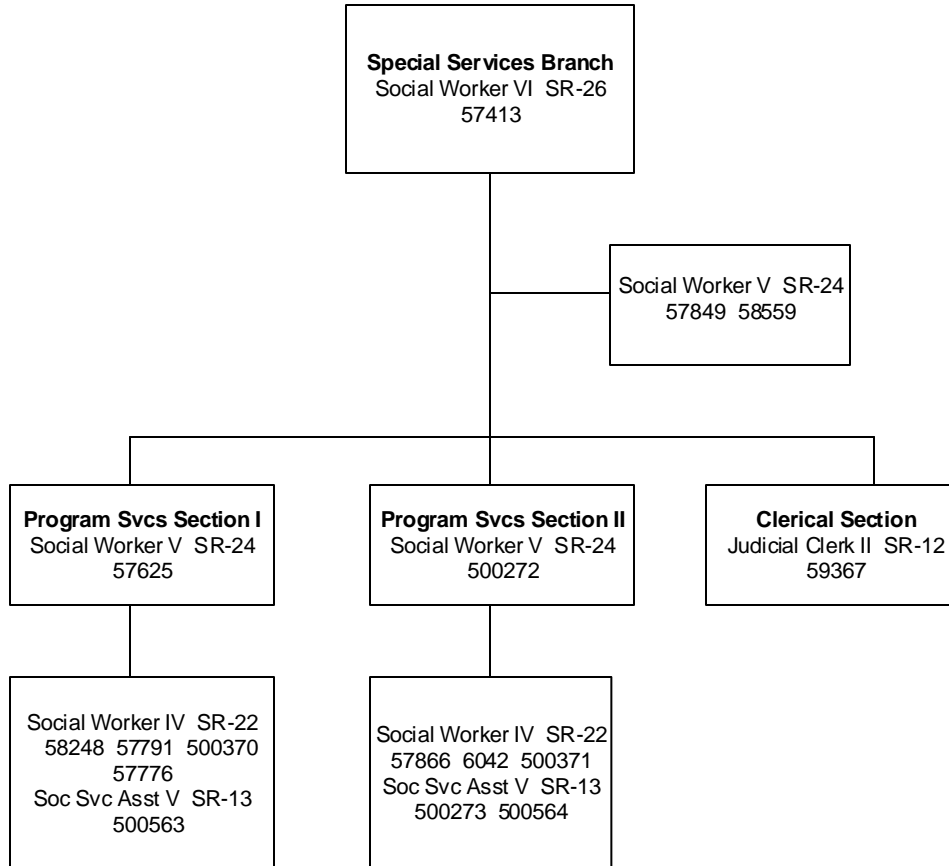

SECOND CIRCUIT

Client Services Division
Drug Court

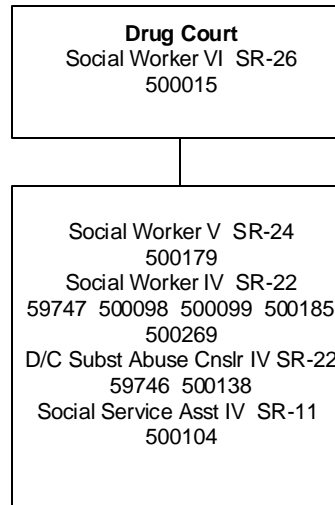

SECOND CIRCUIT

Court & Operational Support Services Division

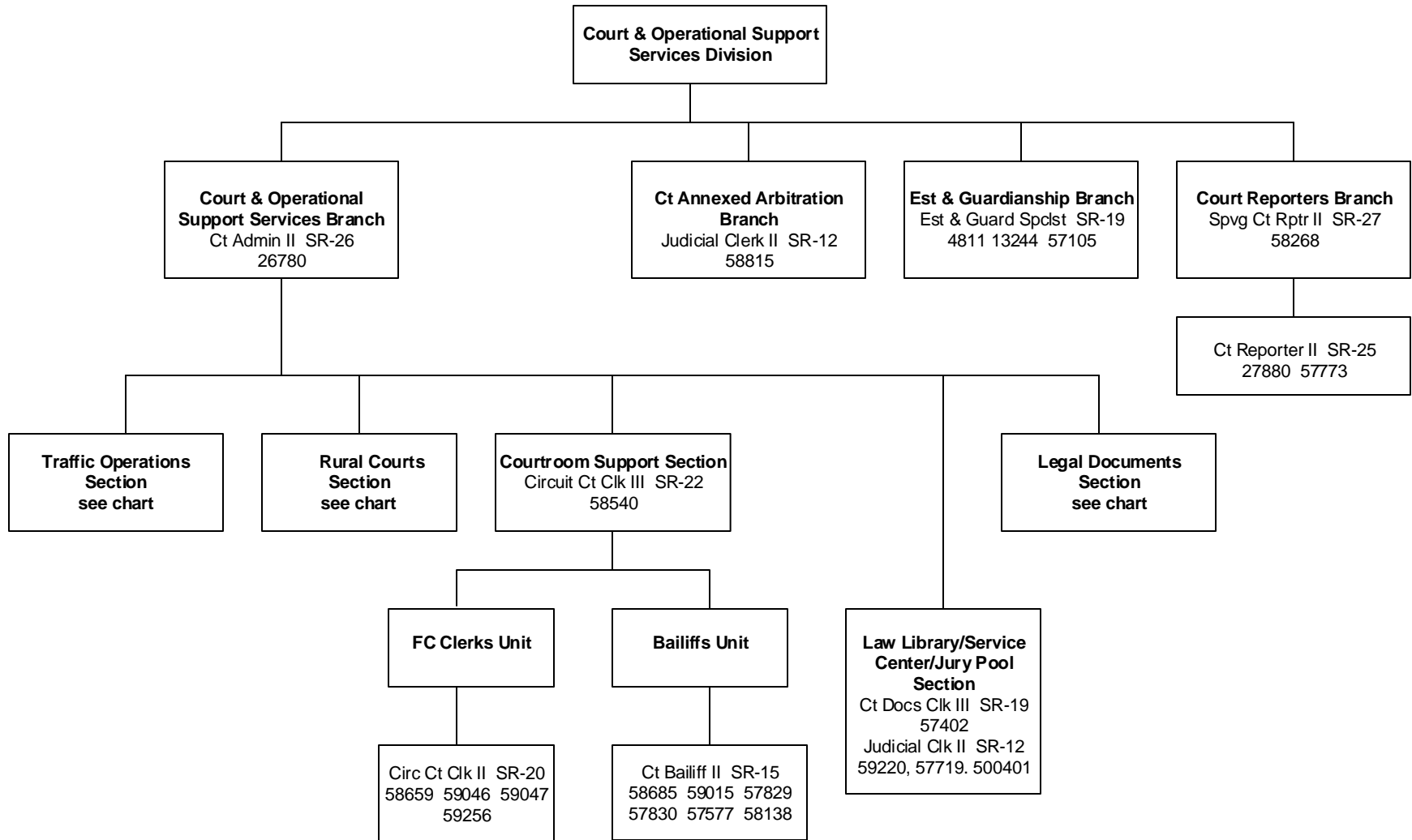

SECOND CIRCUIT

Court and Operational Support Services Division
 Court and Operational Support Services Branch

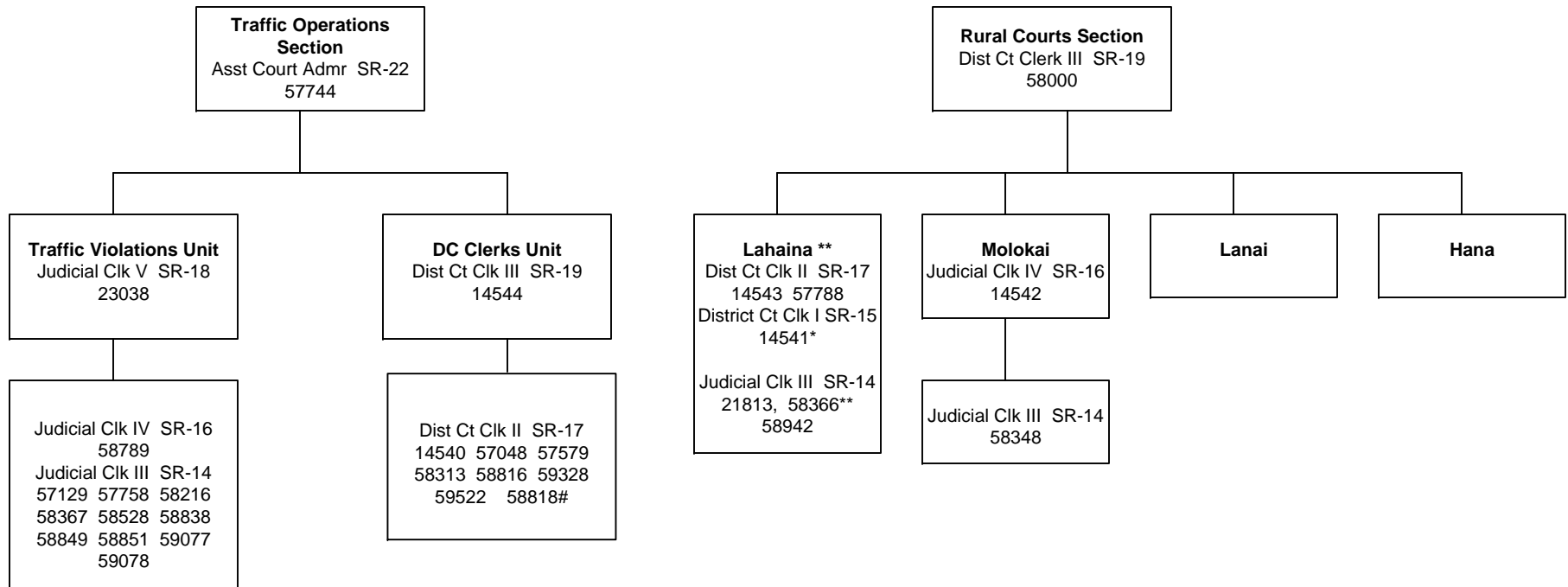

** Provides staff coverage for Lanai and Hana District Courts.

#Position No. 58818 DCC II transferred from Legal Docs Sec, Subunit 2 to DC Clerks Unit.

*14541 trfr psn from DC Clk Unit to Lahaina, DCC I, SR15

Updated May 2018

SECOND CIRCUIT

Court & Operational Support Services Division

Legal Documents Section

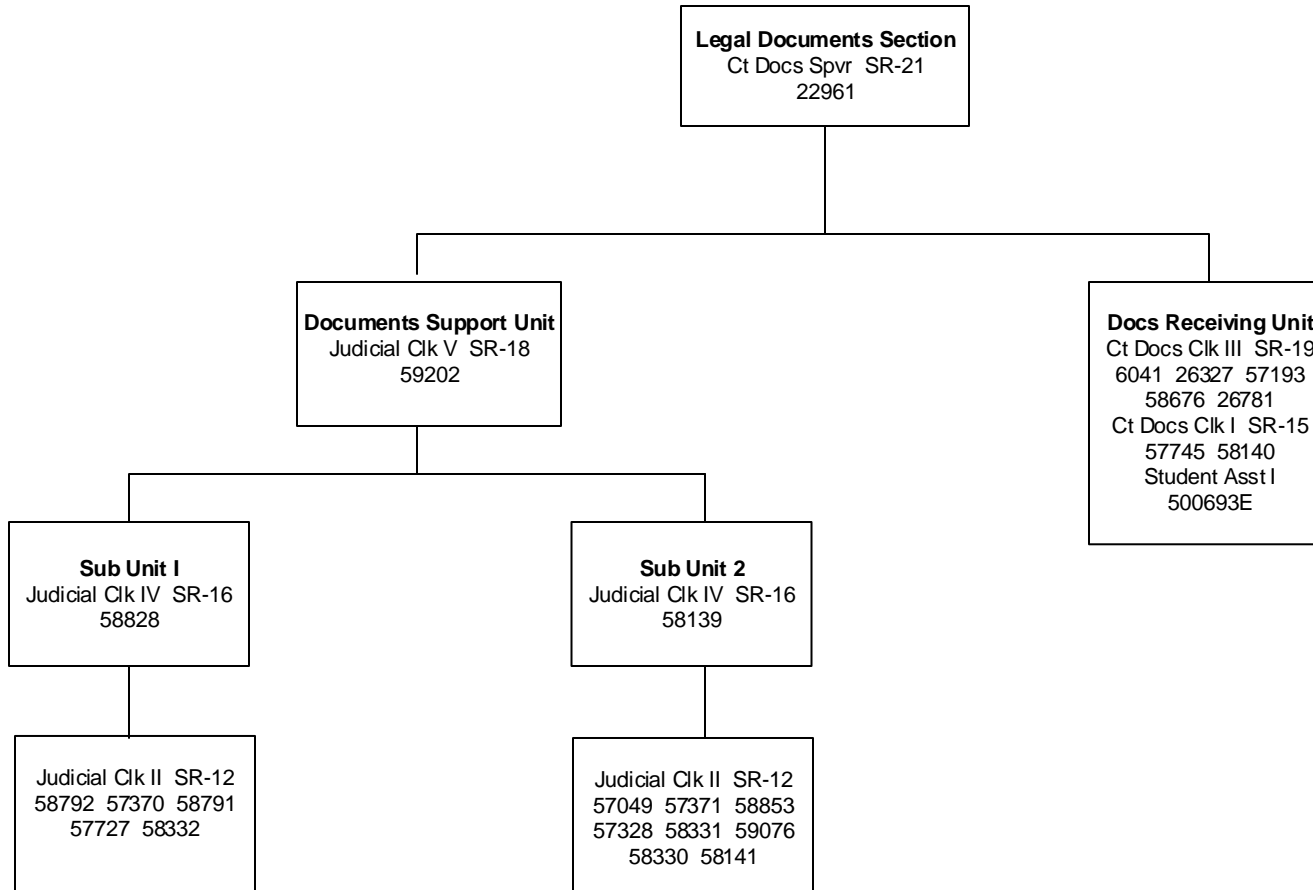

NOTE:

Pos. no. 58793, Judicial Clerk II, transferred from Sub Unit 2 to Cir Ct Judges
Pos no. 58818, Judicial Clerk II, transferred from Sub Unit 2 to Traffic Optns
Sec-DC Clks
Pos no. 58332, Judicial Clerk II, transferred from Sub Unit 2 to Sub Unit 1

Updated December 2017

THIRD CIRCUIT

Circuit Judges

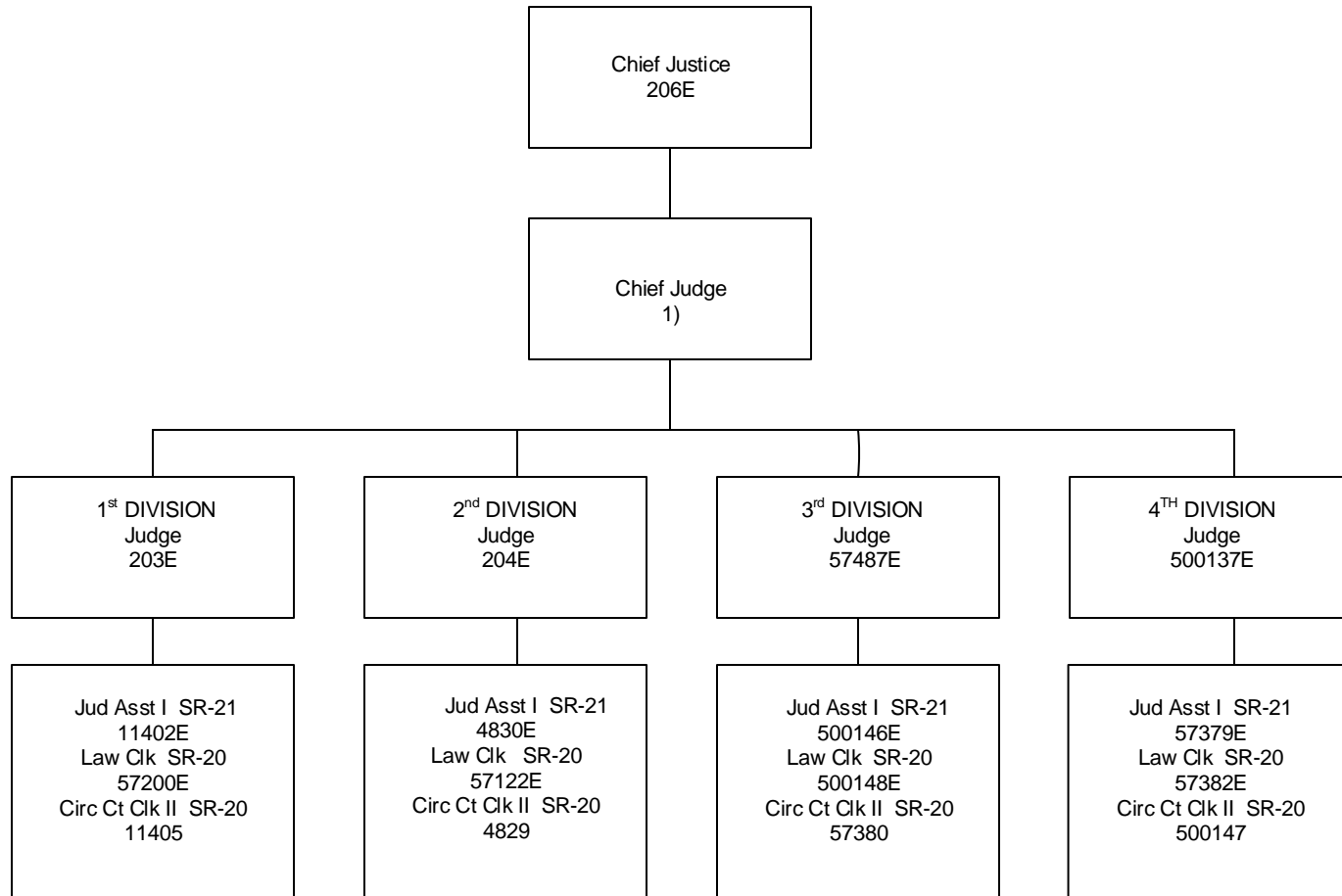

1) Per Chief Justice's order of assignment.

THIRD JUDICIAL CIRCUIT

DISTRICT JUDGES

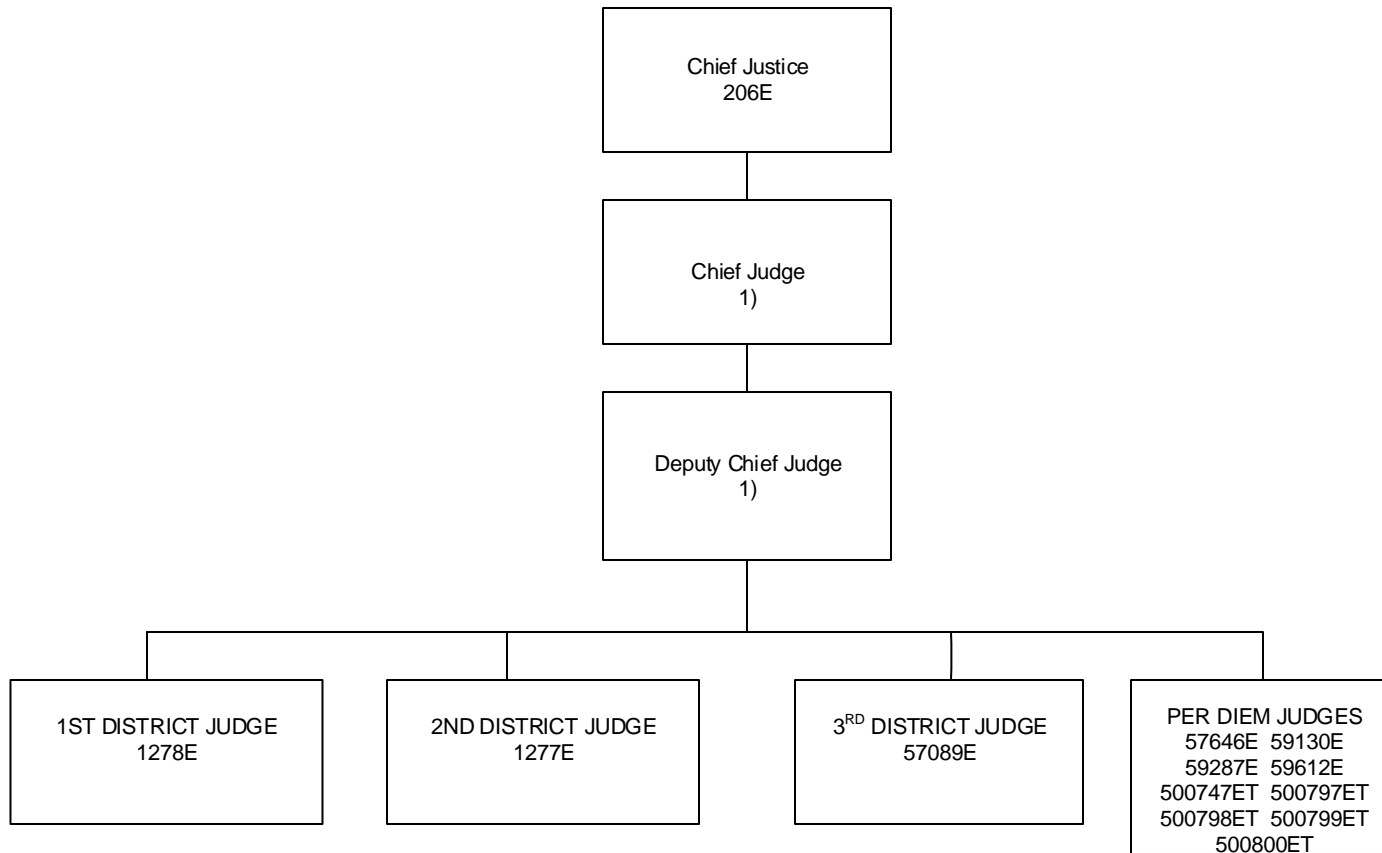

1) Per Chief Justice's order of assignment.

THIRD CIRCUIT

Family Judges

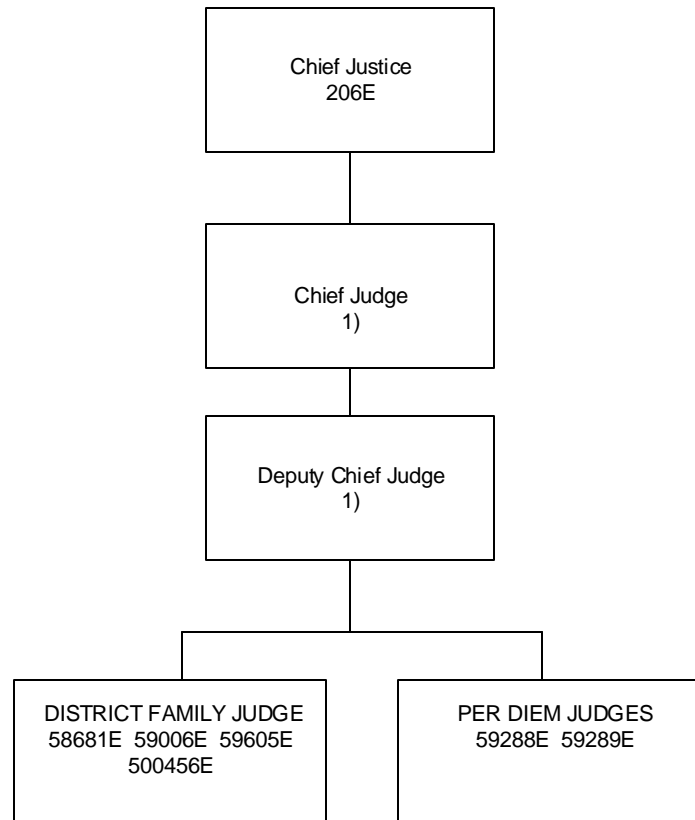

1) Per Chief Justice's order of assignment.

THIRD CIRCUIT

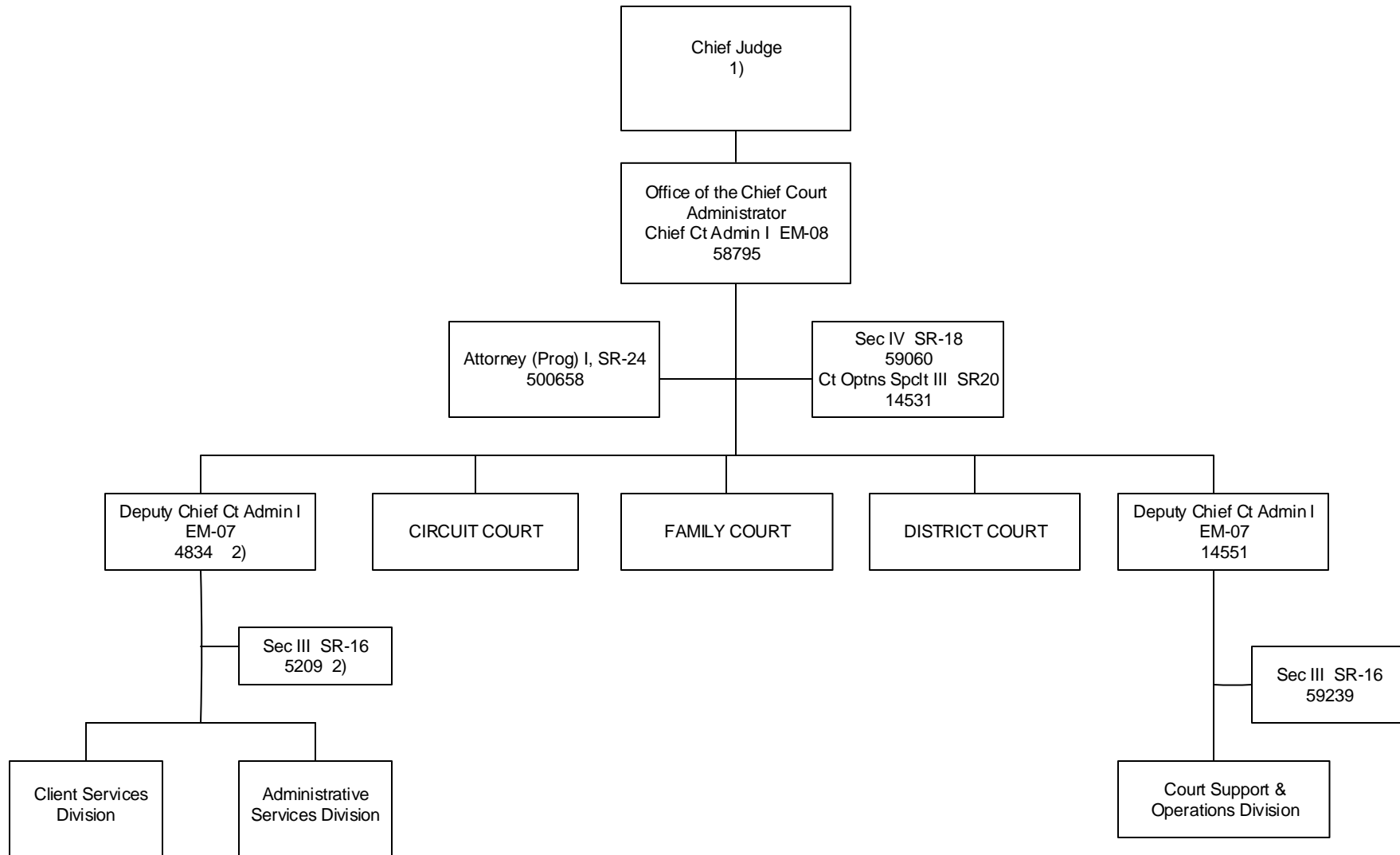

- 1) Per Chief Justice order of assignment.
- 2) Position located in Kona.

THIRD CIRCUIT

Office of The Chief Court Administrator

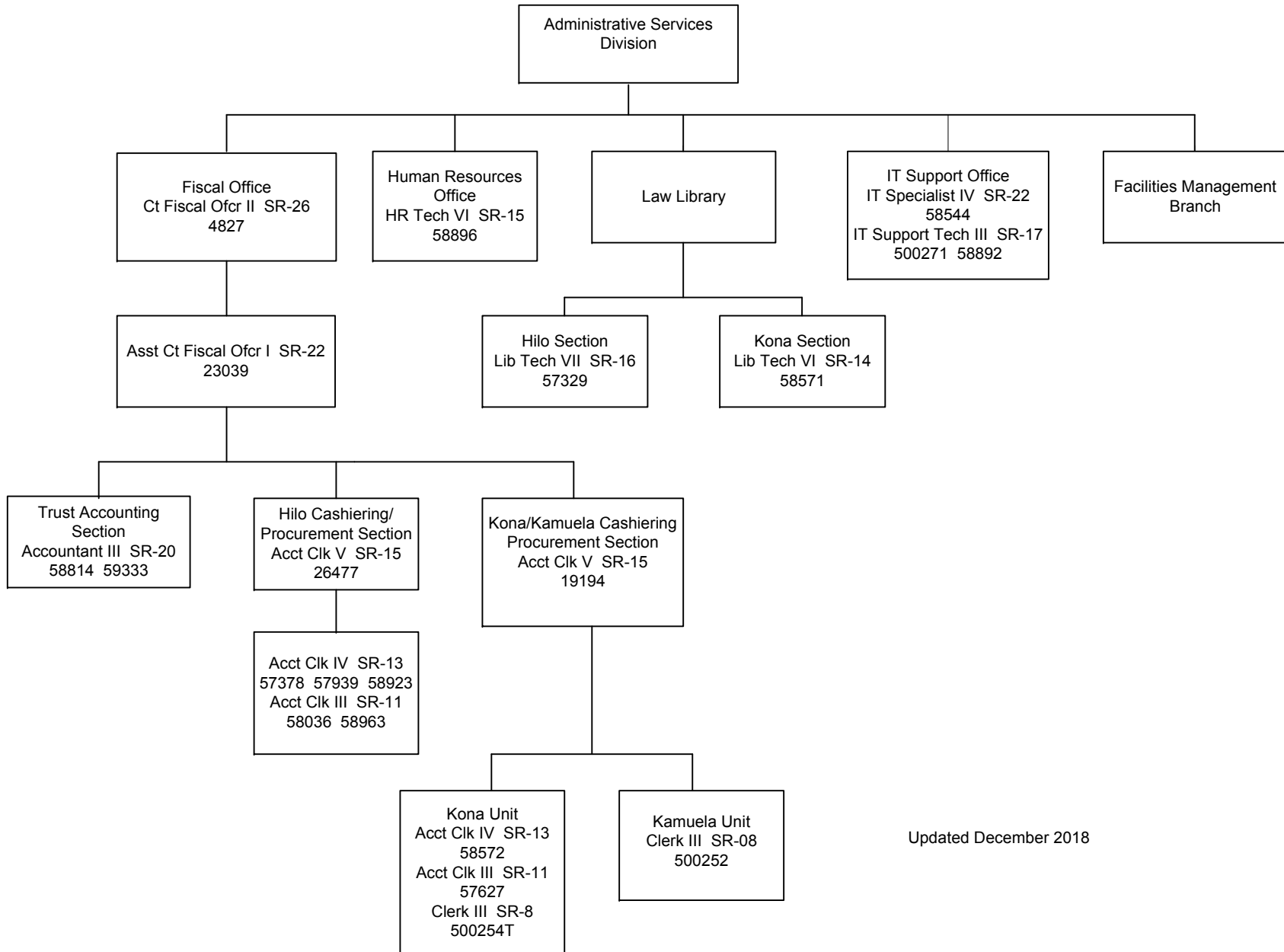

Updated December 2018

THIRD CIRCUIT

Administrative Services Division

Facilities Management Branch

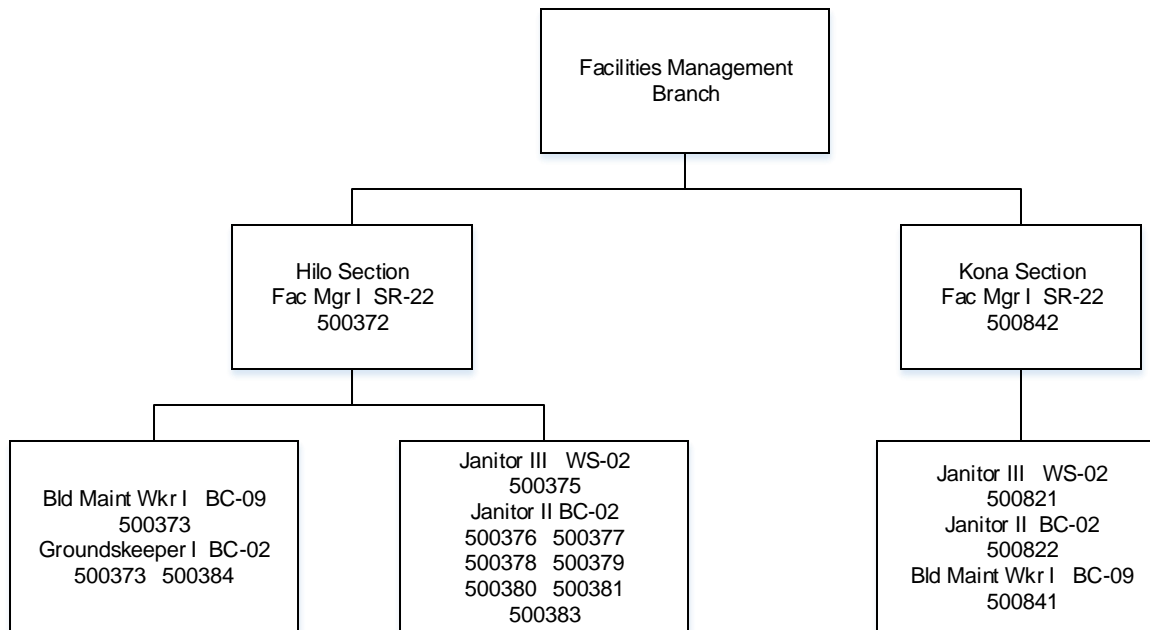

Updated November 2018

THIRD CIRCUIT

Office of The Chief Court Administrator

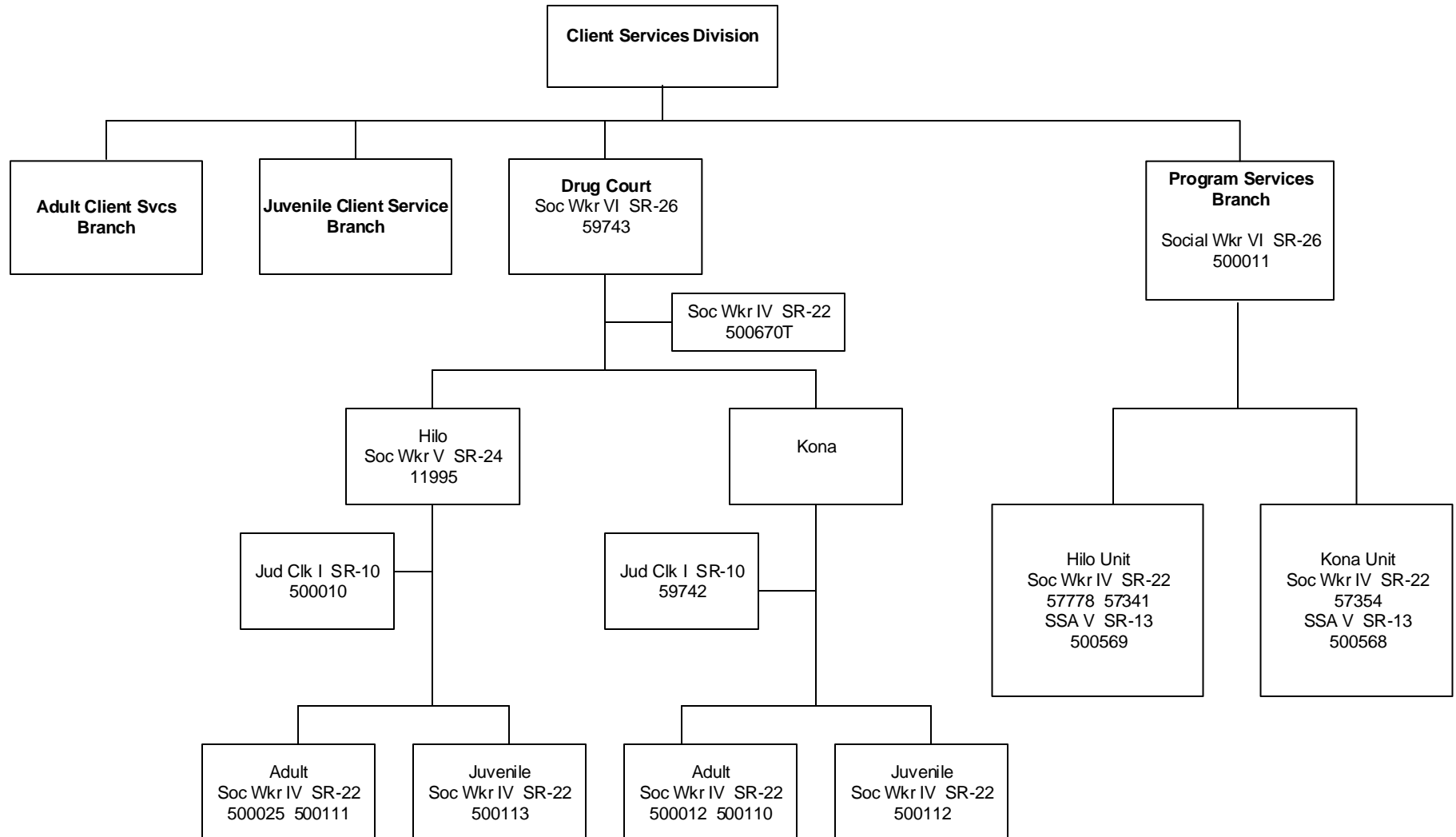

THIRD CIRCUIT

Client Services Division
Adult Client & Services Branch

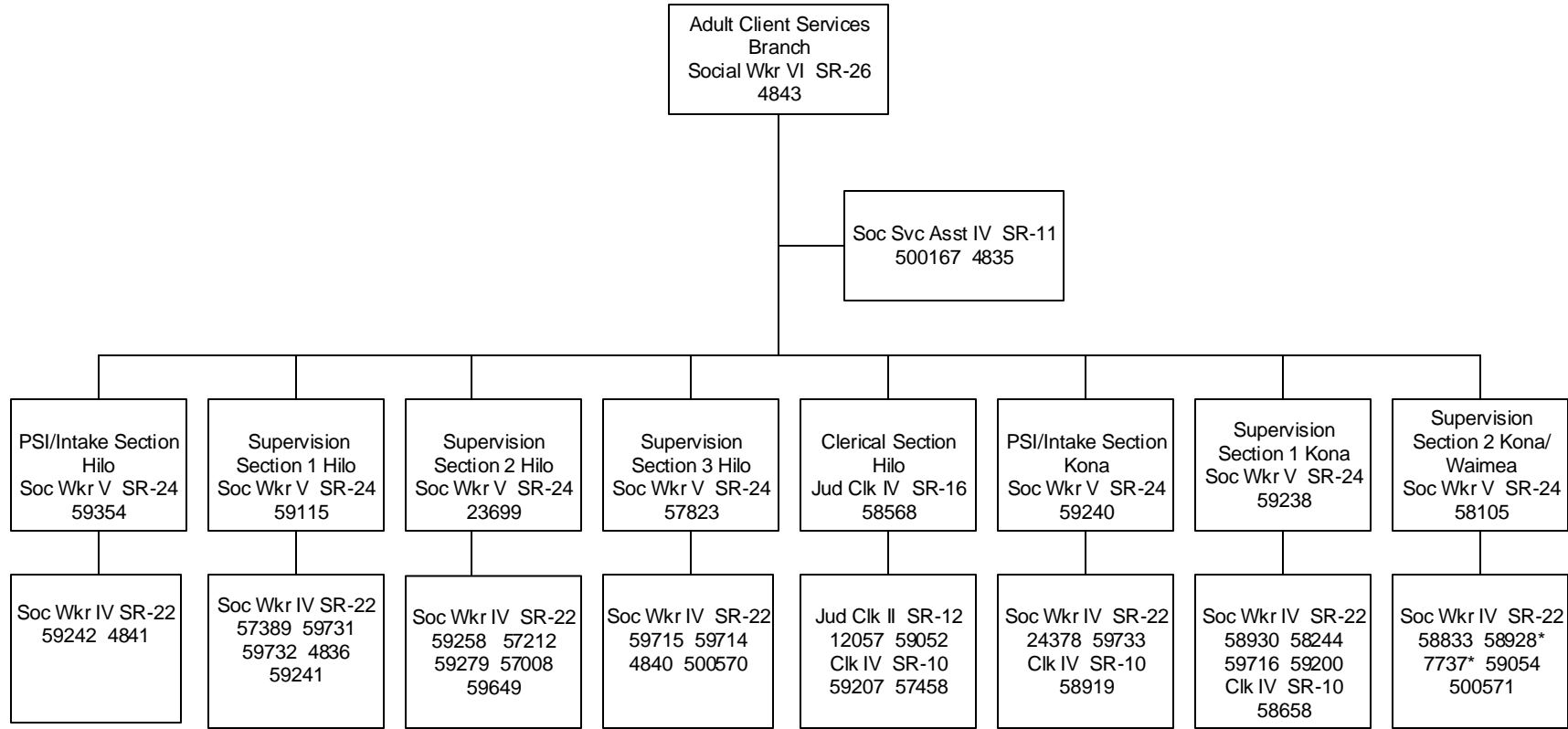

* Position located in Waimea/Kamuela Office.

THIRD CIRCUIT

Client Services Division
Juvenile Services Branch

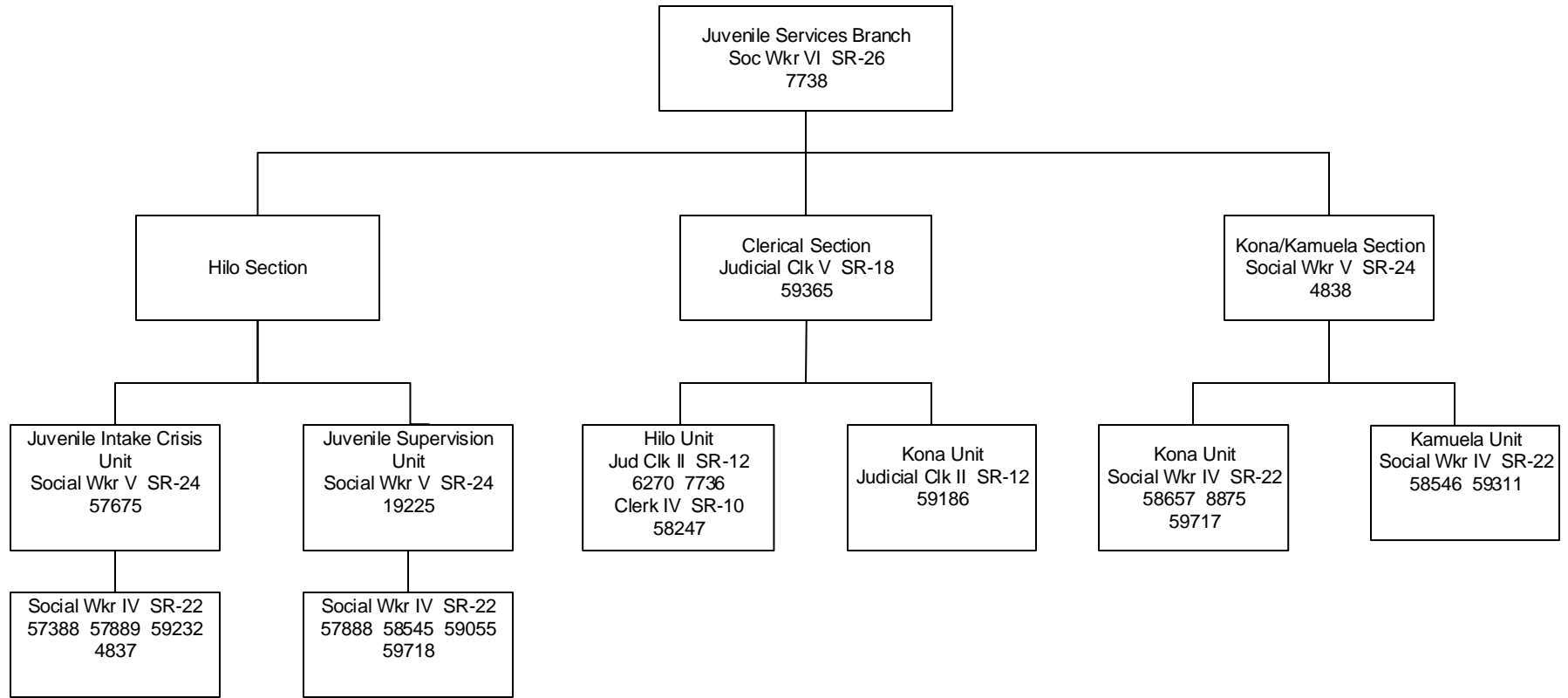

THIRD CIRCUIT

Court Support & Operations Division

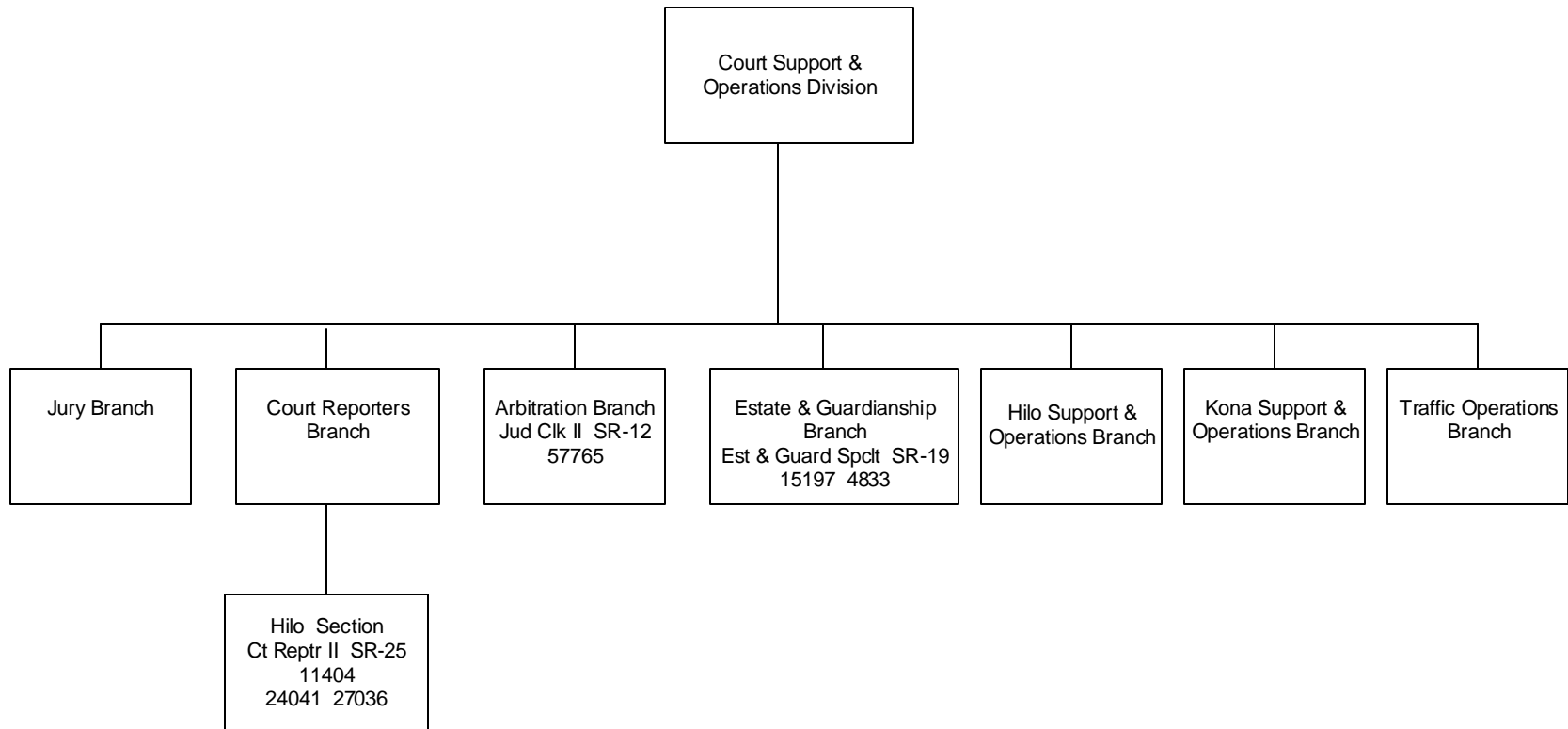

THIRD CIRCUIT

Court Support & Operations Division
Hilo Support & Operations Branch

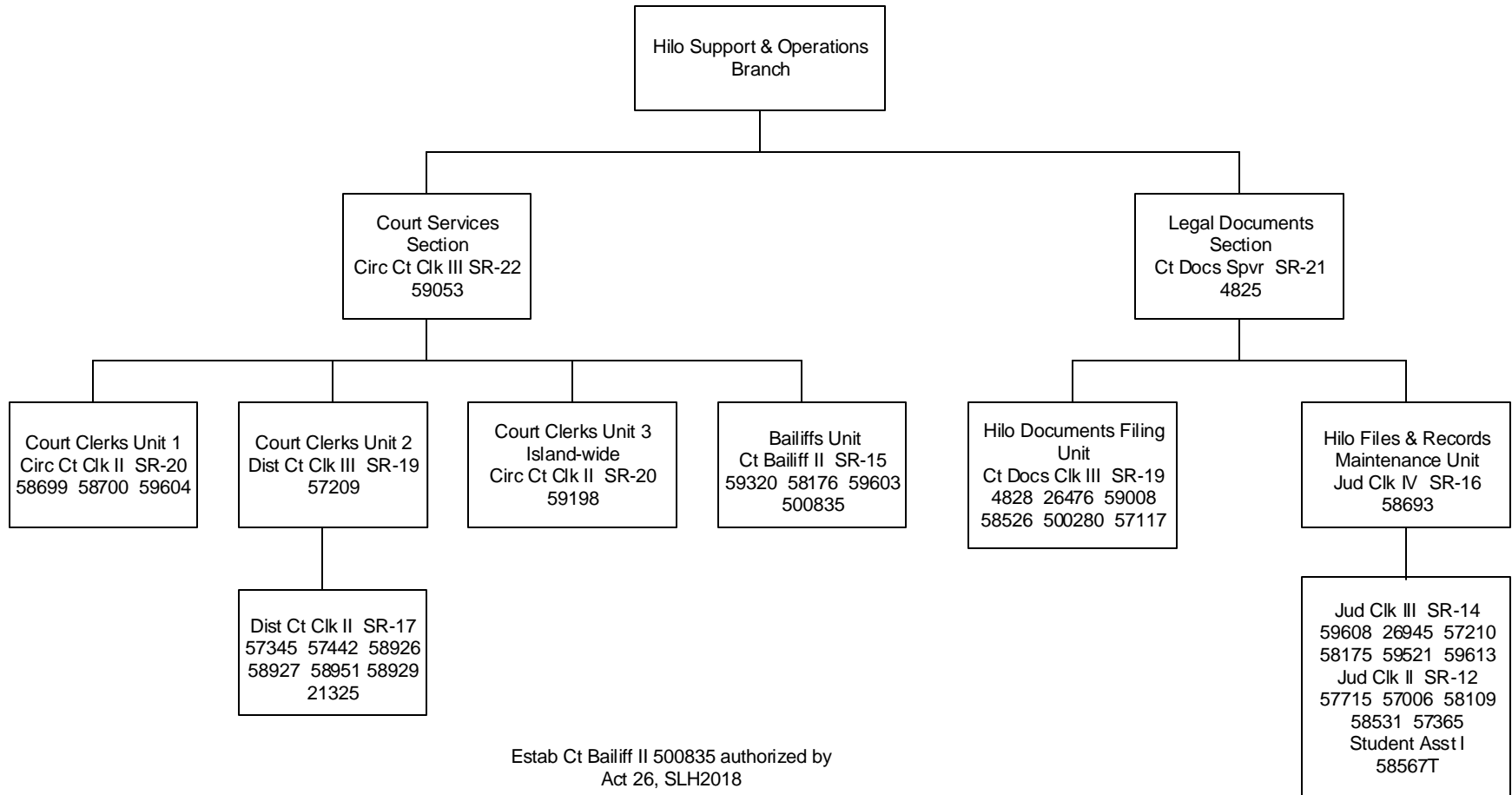

THIRD CIRCUIT

Court Support & Operations Division
Kona Support & Operations Branch

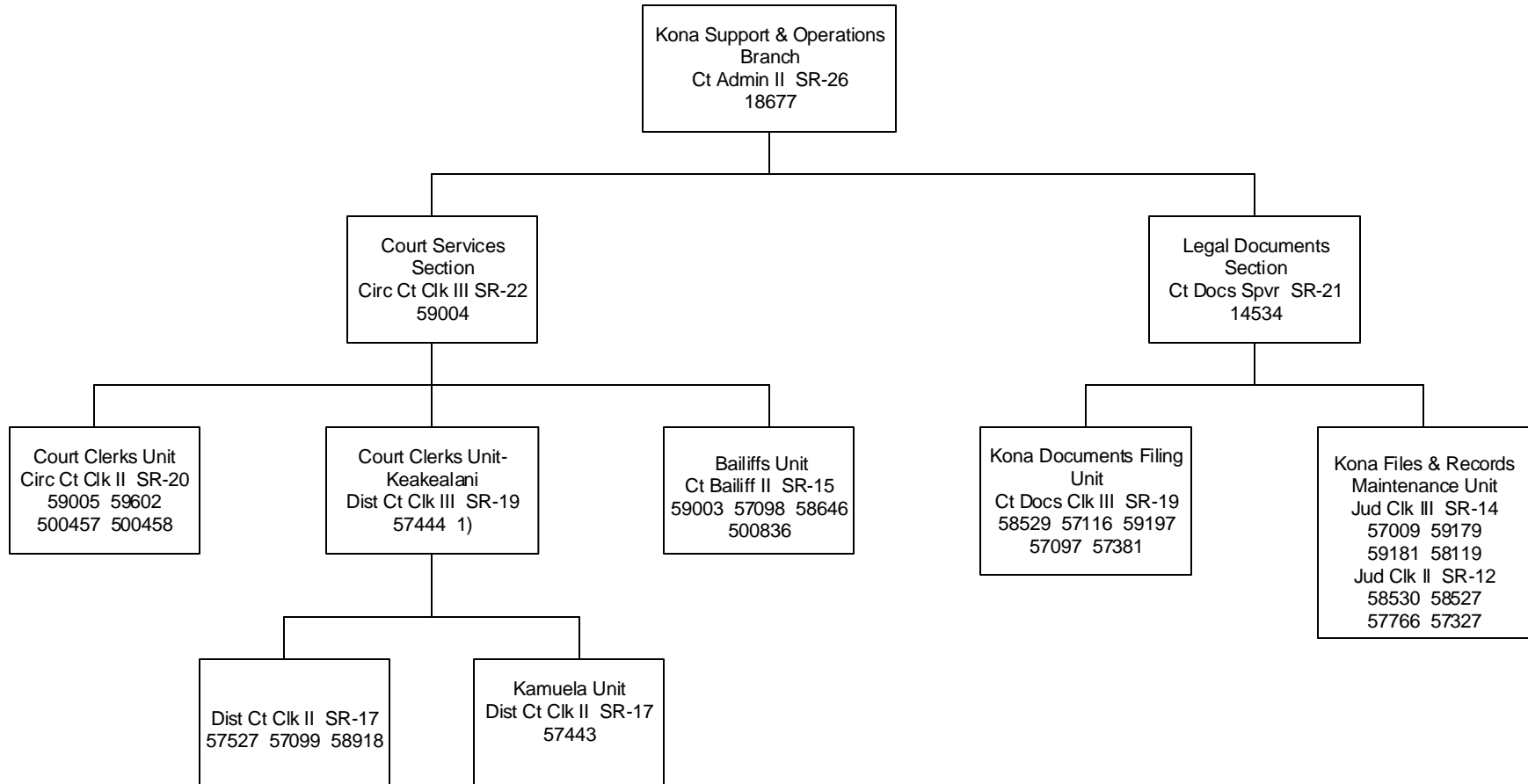

1) Temporary reallocation from District Court Clerk II.

Estab 500836 Ct Bailiff II authorized by Act 26, SLH2018

THIRD CIRCUIT

Court Support & Operations Division
Traffic Operations Branch

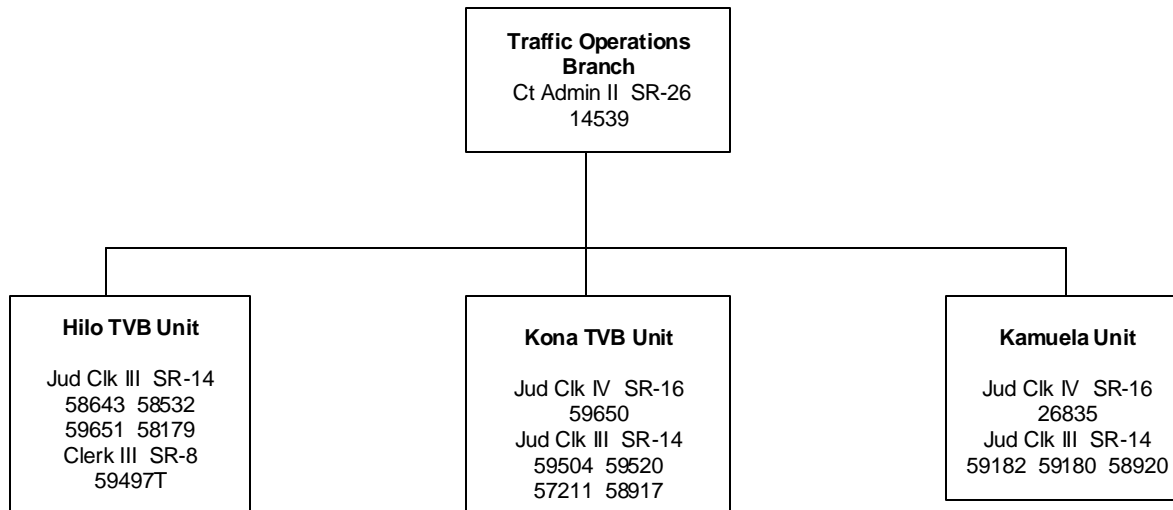

FIFTH CIRCUIT

Circuit Judges

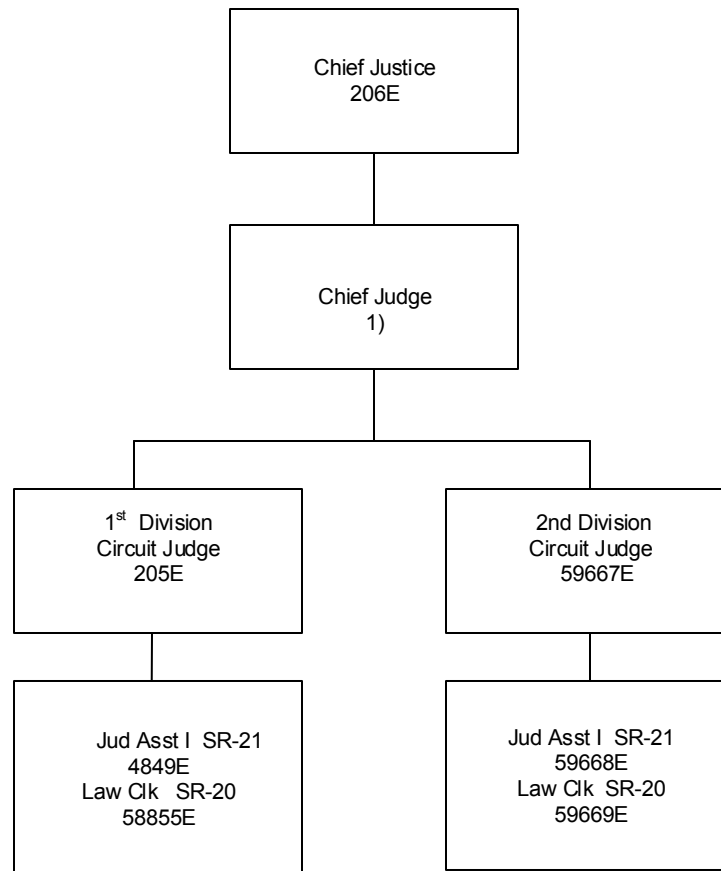

1) Per Chief Justice's order of assignment.

FIFTH CIRCUIT

District Judges

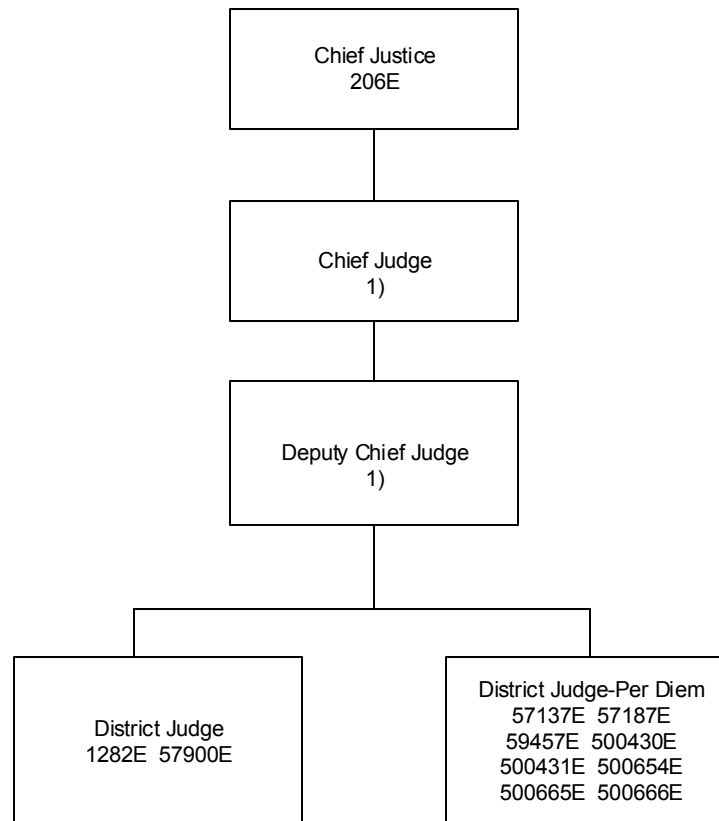

1) Per Chief Justice's order of assignment.

Updated December 2017

FIFTH CIRCUIT

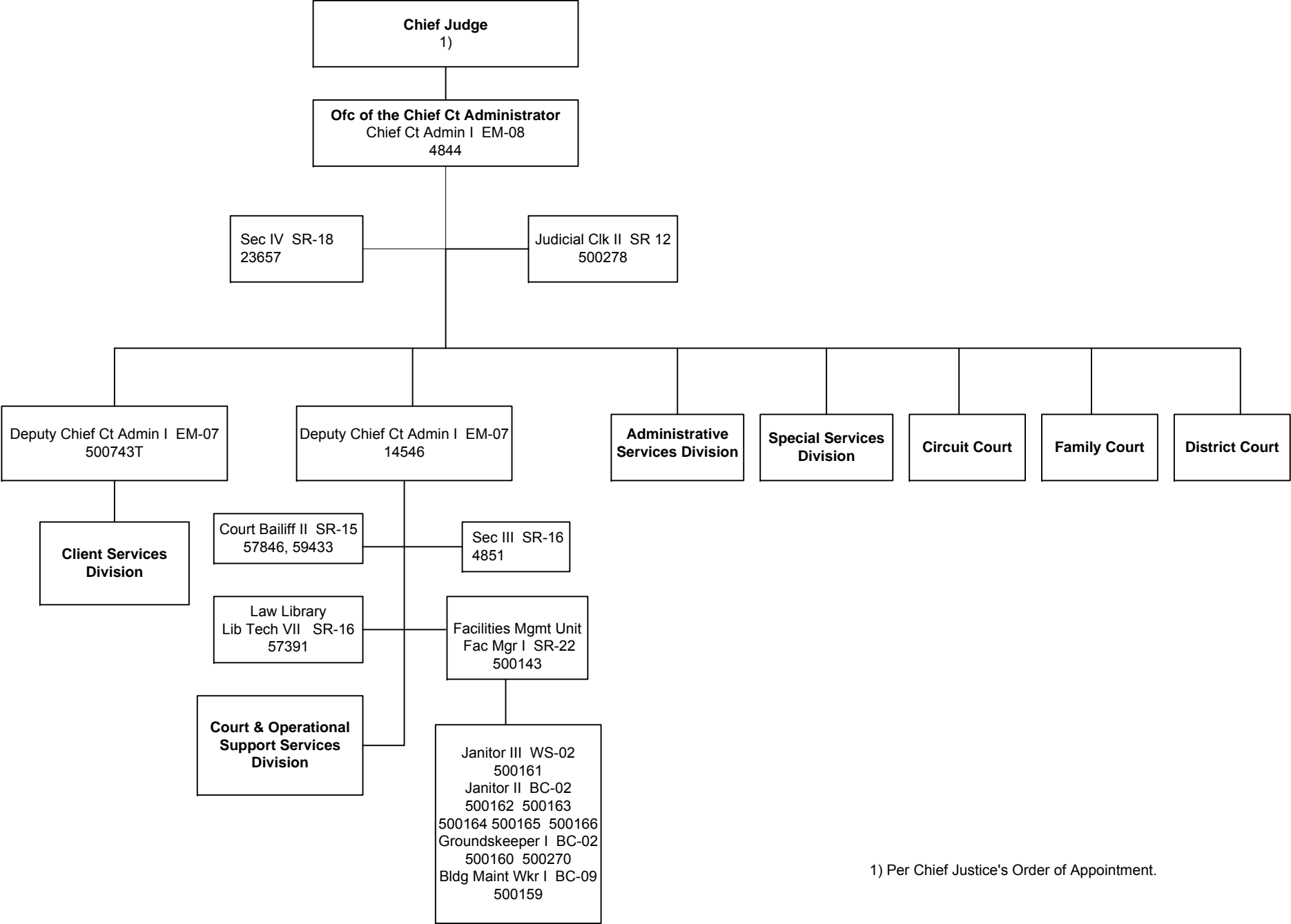

1) Per Chief Justice's Order of Appointment.

FIFTH CIRCUIT

Administrative Services Division

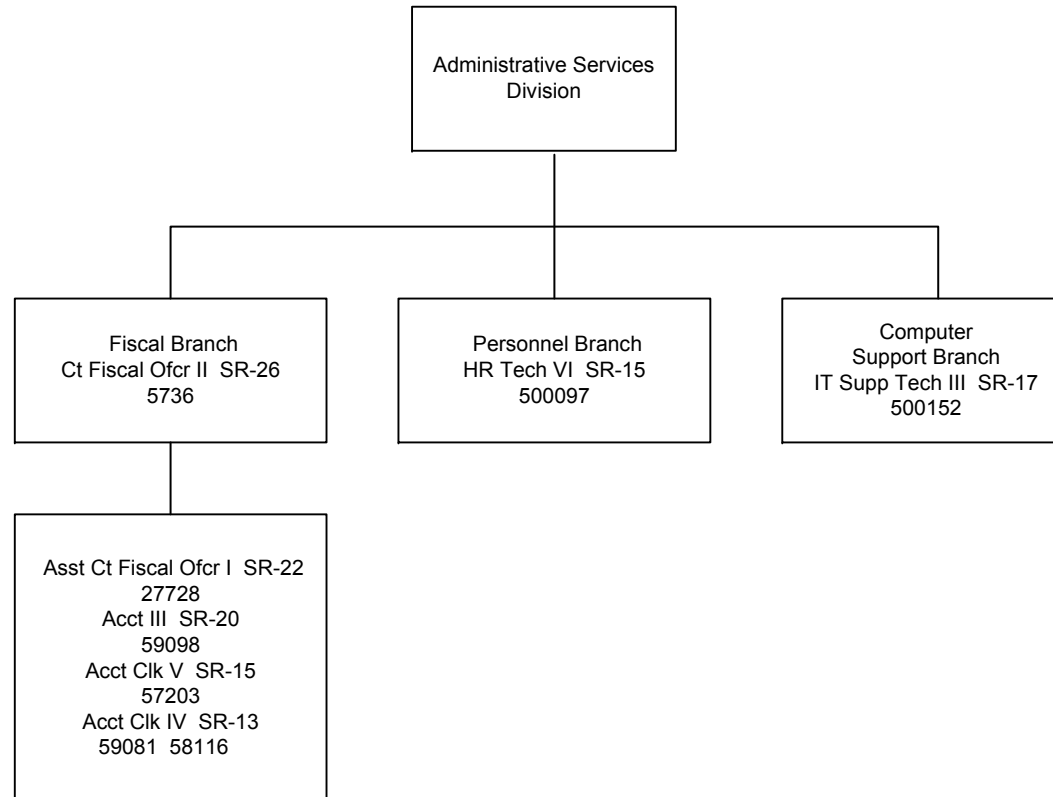

Updated June 2018

FIFTH CIRCUIT

Special Services Division

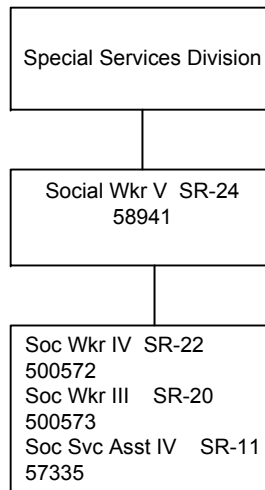

Updated June 2018

FIFTH CIRCUIT

Client Services Division

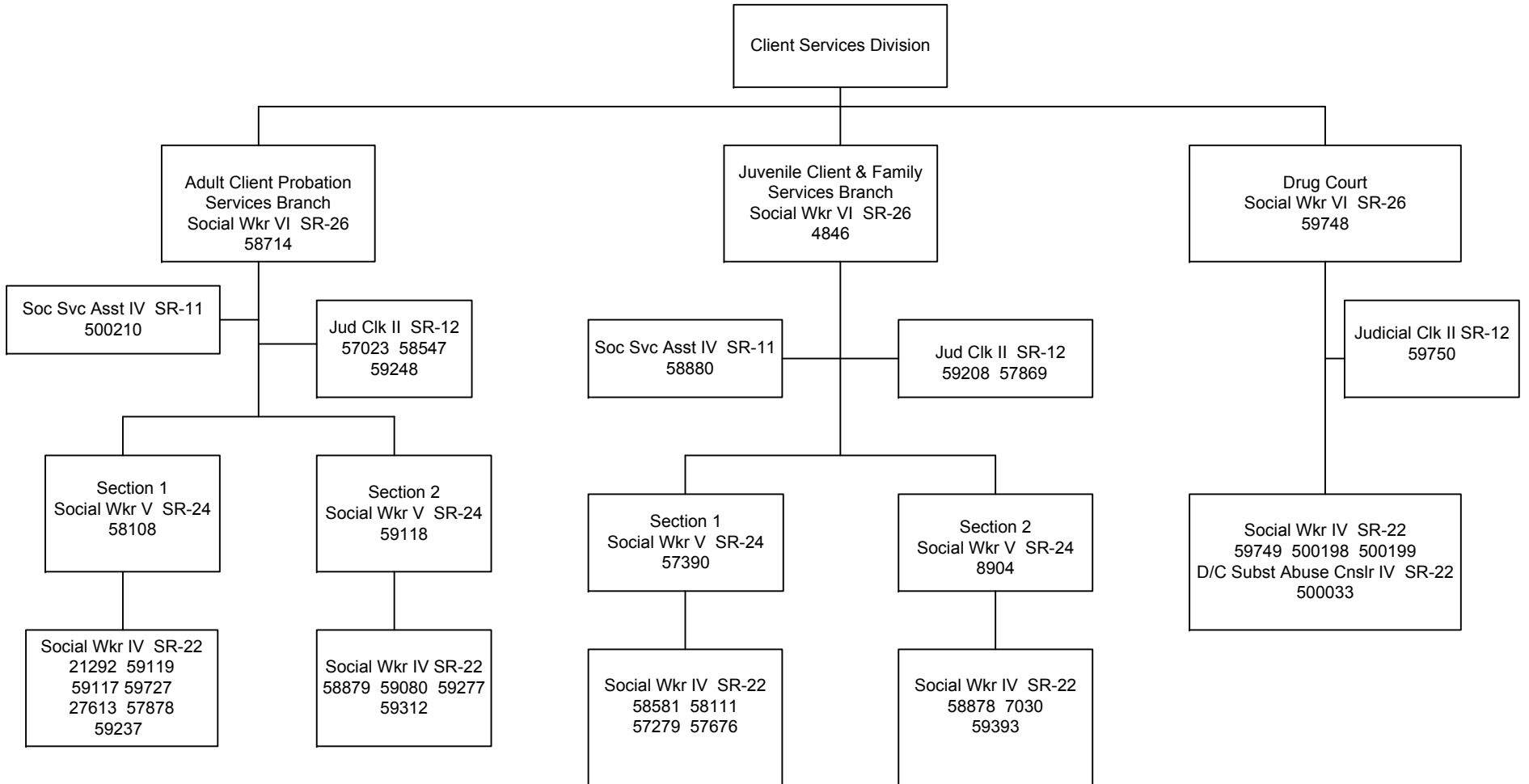

FIFTH CIRCUIT

Court & Operational Support Services Division

APPROVED: _____

Mark E. Recktenwald
CHIEF JUSTICE

DATE: _____

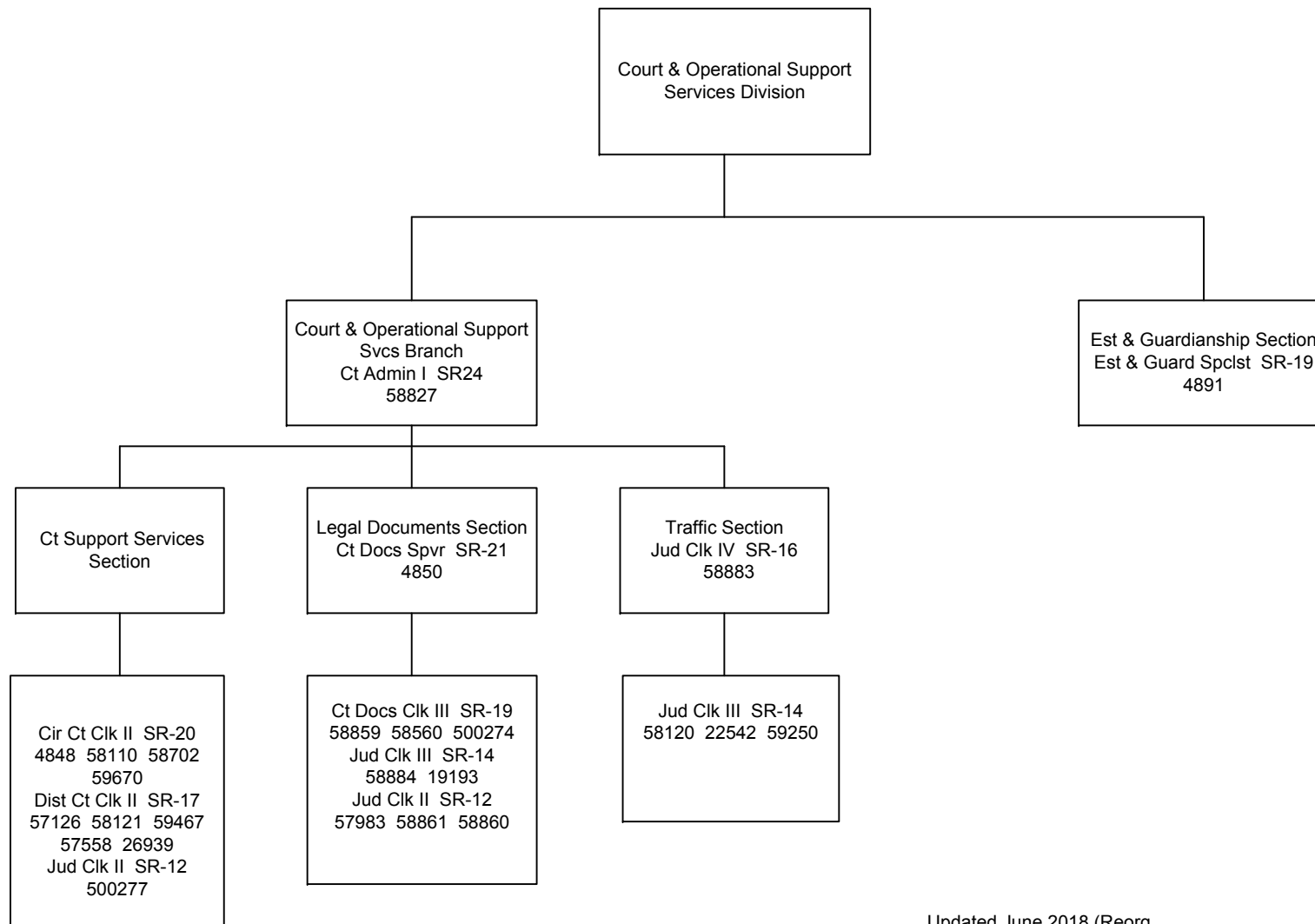

Updated June 2018 (Reorg)