



UNIVERSITY
of HAWAII°
SYSTEM

David Lassner
President

DEPT. COMM. NO. 174

December 23, 2019

The Honorable Ronald D. Kouchi,
President and Members of the Senate
Thirtieth State Legislature
Honolulu, Hawai'i 96813

The Honorable Scott Saiki, Speaker
and Members of the House of Representatives
Thirtieth State Legislature
Honolulu, Hawai'i 96813

Dear President Kouchi, Speaker Saiki, and Members of the Legislature:

For your information and consideration, the University of Hawai'i is transmitting one copy of the Annual Report from the Hawai'i Natural Energy Institute (Section 304A-1891, Hawai'i Revised Statutes) as requested by the Legislature.

In accordance with Section 93-16, Hawai'i Revised Statutes, this report may be viewed electronically at: <http://www.hawaii.edu/offices/government-relations/2020-legislative-reports/>.

Should you have any questions about this report, please do not hesitate to contact Stephanie Kim at 956-4250, or via e-mail at scskim@hawaii.edu.

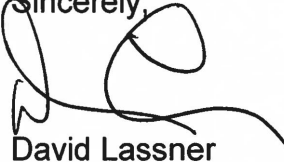
Sincerely,

David Lassner
President

Enclosure

2444 Dole Street, Bachman Hall
Honolulu, Hawai'i 96822
Telephone: (808) 956-8207
Fax: (808) 956-5286

An Equal Opportunity/Affirmative Action Institution

UNIVERSITY OF HAWAI‘I SYSTEM ANNUAL REPORT



REPORT TO THE 2020 LEGISLATURE

Annual Report from the
Hawai'i Natural Energy Institute

HRS 304A-1891

December 2019

Hawai'i Natural Energy Institute

Pursuant to Section 304A-1891, Hawai'i Revised Statutes; A report to the 2019 Hawai'i State Legislature on the work performed by the Hawai'i Natural Energy Institute, including activities, expenditures, contract developed, advances in technology, its work in coordination with state agencies and program, and recommendations for proposed legislation.

Hawai'i Natural Energy Institute

School of Ocean and Earth Science and Technology

University of Hawai'i at Mānoa

Annual Report to the 2020 Legislature

HRS 304A-1891



Annual Report on Activities, Expenditures, Contracts Developed, Advances in Technologies, Work in Coordination with State Agencies and Programs, and Recommendations for Proposed Legislation, required in accordance with HRS 304A-1891 (Act 253, SLH 2007).

1. INTRODUCTION

The Hawai'i Natural Energy Institute (HNEI) was created in 1974 to facilitate the development of natural energy resources and reduce fossil fuel use in Hawai'i. Through multidisciplinary research and education and public-private partnerships, HNEI has emerged as a leader for sustainable energy deployment and demonstration projects in Hawai'i.

In 2007, the Hawai'i Legislature established HNEI in state law with an expanded mandate to coordinate with state and federal agencies, and demonstrate and deploy energy efficiency and peak demand reduction technologies. The law also created the Energy Systems Development Special Fund which receives a portion of the State tax on imported fossil fuels (Barrel Tax), to match funds from federal and private sources, and to award contracts or grants for developing and deploying renewable energy technologies. (HRS Secs. 304A-1891-1894 and Sec. 304A-2169.1)

HNEI conducts research, deploys technology to validate performance for Hawai'i needs, and builds partnerships to support the transition to reliable and affordable clean energy while enhancing the benefits afforded to residents of Hawai'i and beyond. HNEI's

partnerships have included close working relationships with industry and governmental entities at every level including various federal funding agencies, the Hawai'i Public Utilities Commission, the Hawai'i State Energy Office, the Hawai'i Legislature, members of Hawaii's Congressional delegation, and various government and non-government organizations in the Asia-Pacific region. By engaging a wide range of disciplines and stakeholders, HNEI is able to tackle the urgent and complex clean energy needs of our State, the nation, and the global communities in which we serve.

A core part of HNEI's mission is to help guide Hawai'i through its clean energy transformation by focusing on cost effective and practical solutions to help deliver commercially viable renewable energy for Hawai'i. Hawaii's energy transformation is driven by bold state policies that include a mandate for 100% renewable electricity, and carbon neutrality by 2045. (HRS Secs. 269-92 & 225P-5)

To accomplish this mission, HNEI integrates analysis, research, engineering, economics, and science to develop and demonstrate technologies, strategies, and policies that will significantly impact energy transformation initiatives in Hawai'i and beyond.

HNEI's core functions are:

- Research & Development
- Testing & Evaluation
- Modeling & Validation
- Education & Training

These functions are inter-related and overlap by design to maximize collaboration and leverage resources to help accelerate the State's energy transformation.

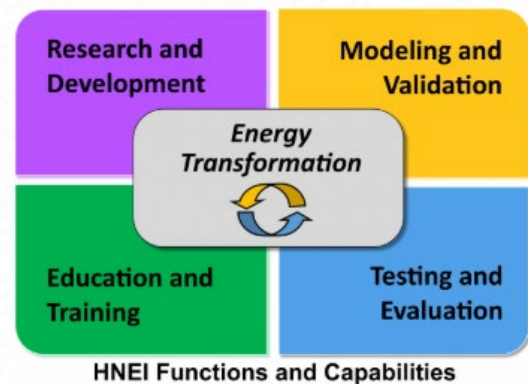

2. HAWAI'I NATURAL ENERGY INSTITUTE SUMMARY OF ACTIVITIES, 2019

Director: Richard E. Rocheleau

| | | |
|-----------|-----------------------------------|----|
| Staffing: | Permanent Faculty (FTE) | 9 |
| | Other permanent staff (APT) | 3 |
| | Temporary Faculty | 19 |
| | Other temporary staff (APT, RCUH) | 17 |
| | Training (a) | 23 |

(a) Includes post-doctoral fellows, graduate and undergraduate students, and visiting scientists.

EXPENDITURES: General Funds \$ 1,346,621
 Tuition and Fees S Funds \$ 6,064
 Research and Training Revolving \$ 517,704
 Extramural Awards \$ 10,002,696
 Energy Systems Development Special Fund \$ 736,783

HNEI has, over the past decade, consistently captured significant extramural funding with a 3 year rolling average of approximately \$ 10 million. These funds support ongoing programs in alternative fuels (including hydrogen and biofuels), grid integration, fuel cells and battery technology, ocean energy, and energy efficiency. HNEI's primary extramural support comes from the Office of Naval Research (ONR) and U.S. Department of Energy. Projects funded by these entities often use Hawai'i as a test site for alternative energy testing in the Pacific region. These programs also support Hawaii's clean energy efforts. The Energy Systems Development Special Fund receives HNEI's portion of the environmental response, energy, and food security tax ("Barrel Tax") pursuant to HRS Section 243-3.5, and is used to leverage funding from federal and private sources, and to develop and deploy technologies to reduce Hawaii's dependence on fossil fuels.

The research and training activities supported by these funds are described below. We anticipate 2020 extramural funding levels to be comparable to those from 2019. The rate of expenditure is expected to be similar to that of 2019.

A. Research Areas

This section of the Annual Report provides a brief introduction to each of HNEI's main areas of research. Within these areas, HNEI manages approximately 50 discrete projects. Details of the work for each of these 50 projects are summarized in HNEI's one-page summaries called "Research Highlights" that are included as an appendix to this Report. HNEI's Research Highlights provide a brief and concise description of active HNEI research projects in an easily accessible format. The Research Highlights,

as well as more detailed reports, papers and descriptions of HNEI's work activities are available on its website (hnei.hawaii.edu).

(1) Alternative Fuels

Alternative fuels, for both transportation and power generation, are an important component of Hawaii's efforts to reduce its dependence on imported petroleum. HNEI conducts research, testing, and evaluation that supports the development of alternative fuels including biomass and biofuels, hydrogen and solar fuels, and methane hydrates. HNEI also conducts analysis and planning to assess the potential for alternative fuels, such as an analysis of the potential for the use of renewable natural gas to meet Hawai'i energy needs. Funding sources for research in the alternative fuels area include the Office of Naval Research, the U.S. Department of Energy, the Federal Aviation Administration, JANUS, DARPA, and the Energy Systems Development Special Fund.

The following projects in the alternative fuels area are described in the HNEI Research Highlights appended to this report:

- Solar Fuels Generation
- Sustainable Aviation Fuel Production
- Fuel Characterization by Multidimensional Gas Chromatography
- Liquid Fuels from Synthesis Gas
- PHA Bioplastics from Biomass
- High Rate Anaerobic-Aerobic Digestion
- Methane Hydrates
- Methane Dissolution Rates in the Deep Ocean
- Microbial Degradation of Hydrocarbons in Marine and Estuarine Environments
- Methane Harvesting for Seafloor Power Generation

(2) Grid Integration

Hawai'i is at the forefront of tackling the problem of renewable energy integration. The geographic isolation of the islands' electricity grids and the exponential growth of renewable generation make Hawaii's electricity grids particularly susceptible to the effects of intermittent renewable energy sources, but also an ideal test bed for energy storage solutions. HNEI develops new technology, tests emerging technologies from other sources, and conducts analysis supporting Hawaii's clean energy goals. Funding sources for research in the grid integration area include the US Department of Energy, the Office of Naval Research, Naval Facilities Command via the Applied Research Laboratory, and the Hawai'i State Energy Office.

The following projects in the grid integration area are described in the HNEI Research Highlights appended to this report:

- Advanced Power System Laboratory (APSL)
- Advanced Real-Time Grid Energy Monitor System (ARGEMS)
- Molokai Battery Energy Storage System
- Solar Power Forecasting
- NELHA HOST Park Micro-grid Analysis
- Marine Corps Base Hawai'i Installation Energy Plan
- Dynamic Load Bank – Secure Micro-grids
- Coconut Island DC Micro-grid
- Load and PV Data Synthesis
- Bi-directional EV Charging Demonstration Project
- Advanced Conservation Voltage Reduction Development & Demonstration
- Sustainable Grid Platform with Enhanced System Layer and Fully Scalable Integration

(3) Fuel Cell & Battery Technology

HNEI conducts research, development, testing, and evaluation of fuel cell and battery technologies. The primary goal of these efforts is to understand their performance and durability for both commercial and military applications including electric and fuel cell electric vehicles, fuel cell powered unmanned aerial and undersea vehicles, and ancillary services for the electric grid. Funding sources for research in the fuel cell and battery technology area include the US Department of Energy, the Office of Naval Research, the Army Research Office, and the Energy Systems Development Special Fund.

The following projects in the fuel cell and battery technology area are described in the HNEI Research Highlights appended to this report:

- NELHA Hydrogen Station & Fuel Cell Electric Buses
- Battery Energy Storage Systems Durability & Reliability
- Path Dependence of Battery Degradation, EV Batteries for Grid Support
- Water Purification with Ion Exchange Membrane and Porous Media
- Fuel Cell Development for Electric Powered Unmanned Aerial Vehicles
- Development of Magnesium Boride Etherates as Hydrogen Storage Materials
- Development of Novel Air Filtration Materials
- Active and Durable pgm-Free Catalysts for Fuel Cell Applications

- Mass Transfer Analysis for High Power Fuel Cells
- Proton Exchange Membrane Fuel Cell Contamination
- Transition Metal Carbide Catalysts for Electrochemical Energy Storage

(4) Renewable Power Generation

As a result of technological advances, high cost of electricity in Hawai'i, and generous federal and state incentives, deployment of renewable power generation is growing rapidly across Hawai'i. HNEI's primary focus is in the areas of grid integration and policy. However, HNEI continues to explore opportunities for new renewable technologies that could eventually contribute to our island energy needs. This work includes significant support for ocean energy technologies; small wind systems; and new, potentially lower cost solar materials. Funding sources for research in the renewable power generation area include the US Department of Energy, the Office of Naval Research, and NAVFAC.

The following projects in the renewable power generation area are described in the HNEI Research Highlights appended to this report:

- Printable Photovoltaics
- Research Support to the U.S. Navy Wave Energy Test Site

(5) Energy Efficiency and Transportation

Hawai'i has aggressive goals for reduction of fossil fuel usage through energy efficiency. HNEI's primary activities in this area include research on high efficiency buildings, building energy management; and Seawater Air Conditioning (SWAC) to replace conventional AC systems. HNEI also conducts research to support the development and deployment of advanced transportation systems with efforts currently focused on the acceptance and integration of electric vehicles. Here, our objective is to contribute to a sustainable transportation system by analyzing, modeling, and demonstrating replacement fuels, infrastructure and critical technologies. Funding sources for research in the energy efficiency and transportation area include the Office of Naval Research and the Energy Systems Development Special Fund.

The following projects in the energy efficiency and transportation area are described in the HNEI Research Highlights appended to this report:

- Adaptive Lighting and Energy Efficient Security Strategy
- Building Energy Reduction in Future Transit Oriented Development Areas

- Ka Honua Momona: Maximizing Efficiency of Off-grid Nano-grid
- Project FROG Net Zero, Mixed Mode Buildings
- Electrified Transportation

(6) Hawai'i Energy Analysis and Policy

In Hawai'i, HNEI closely collaborates with the State Energy Office and the Public Utilities Commission to support state energy policy and Hawaii's energy transformation. We provide independent and impartial research, analyses, demonstration and testing to help inform critical decisions made by regulators, legislators, utilities, and other energy stakeholders. Our independent technical analyses inform planning and policy decisions by the state's utilities, regulators and other energy stakeholders. HNEI is committed to supporting State and Federal agencies, and industry in planning and implementing clean energy initiatives. Funding sources for research in the Hawai'i Energy Analysis and Policy area include the Office of Naval Research, and the Energy Systems Development Special Fund, and the Korea Institute of Energy Technology Evaluation and Planning.

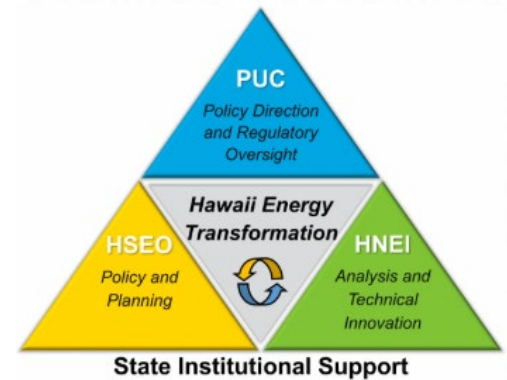

To promote wider understanding of the technical and policy issues associated with the State's energy transformation, HNEI has begun publishing its "HNEI Energy Briefs." These are a new series of informative, short, plain-language documents describing aspects of Hawaii's energy transformation challenges, possible solutions, and the methods used by HNEI to analyze and evaluate them. The HNEI Energy Briefs are intended to engage an audience beyond just energy stakeholders, and foster understanding and informed discussion for anyone interested in learning more about Hawaii's renewable energy progress. Initial Briefs include:

- A Primer on Grid Operations and Planning
- How are Wind and Solar Different?
- Where is Hawai'i in the Renewable Energy Transition?
- Modeling & Simulation Methods for Hawai'i's Grids
- Managing Solar Oversupply
- Introduction to Battery Energy Storage
- Storage Utilization and Scheduling for Energy Shifting
- Electrification of Transportation

The briefs will be published regularly and are available on HNEI's website.

The following projects in the Hawai'i energy analysis and policy area are described in the HNEI Research Highlights appended to this report:

- Technical and Decision Support Services to the Hawai'i PUC
- Integrated Grid Planning Support
- Hawai'i Energy Policy Forum
- Energy Briefs
- Grid Integration of Solar and Storage
- Electric Vehicle Emissions Impacts in Hawai'i

(7) International Support

HNEI also supports efforts in the Asia Pacific Region with planning and policy development for countries and regions transitioning to renewable energy. Recent work has included activity in Thailand and Viet Nam, as well as research collaborations with South Korea and India. Funding sources for research in the international area include the Office of Naval Research, and the Korea Institute of Energy Technology Evaluation and Planning, and the U.S. Department of Energy.

The following projects in the international support area are described in the HNEI Research Highlights appended to this report:

- EGAT (Thailand)Renewable Integration Study
- U.S. India Collaborative for Smart Distribution with Storage (UI-ASSIST)
- Vietnam Low Emission Energy Program (V-LEEP) RPS Development
- Field Verification of AI-based Microgrid (MG)

B. Contracts Developed

HNEI has developed many subcontracts under its extramural federal funding, and contracts using the Energy Systems Development Special Fund. The work using this funding are described in the Research Highlights attached in the appendix to this Report. HNEI coordinated and planned for ESDSF expenditures with the State Energy Coordinator.

C. Advances In Technology

HNEI continues to conduct research to advance renewable energy technologies and system integration. HNEI has patent applications and/or patents in several of its research areas, some of which are described in the Research Highlights attached in the appendix to this Report.

D. Coordination With State Agencies

HNEI works closely with DBEDT and other agencies on a variety of renewable energy and energy efficiency projects and continues to seek new opportunities and means to do so. Some of these projects initiated or ongoing in 2019, which involve strong collaboration/coordination with state agencies are described in the Research Highlights attached in the appendix to this Report.

E. Recommendations For Proposed Legislation

Generally, HNEI does not initiate legislation, but endeavors to inform legislators with unbiased information and analysis on matters relevant to pending issues, bills, and proposals where appropriate. HNEI is a member of the Hawai'i Energy Policy Forum and works closely with this group to review legislative initiatives in the energy area. HNEI also supports the University of Hawai'i's Hawai'i Energy Policy Forum for outreach and analysis efforts via federal funds and the Energy Systems Development Special Fund.

APPENDIX

HNEI Research Highlights

| <u>Alternative Fuels</u> | |
|------------------------------------------------|-------------------------------------------------------------------------------------|
| 1 | Solar Fuels Generation |
| 2 | Sustainable Aviation Fuel Production |
| 3 | Fuel Characterization by Multidimensional Gas Chromatography |
| 4 | Liquid Fuels from Synthesis Gas |
| 5 | PHA Bioplastics from Biomass |
| 6 | High Rate Anaerobic-Aerobic Digestion |
| 7 | Methane Hydrates |
| 8 | Methane Dissolution Rates in the Deep Ocean |
| 9 | Microbial Degradation of Hydrocarbons in Marine and Estuarine Environments |
| 10 | Methane Harvesting for Seafloor Power Generation |
| | |
| <u>Grid Integration</u> | |
| 11 | Advanced Power System Laboratory (APSL) |
| 12 | Advanced Real-Time Grid Energy Monitor System (ARGEMS) |
| 13 | Molokai Battery Energy Storage System |
| 14 | Solar Power Forecasting |
| 15 | NELHA HOST Park Micro-grid Analysis |
| 16 | Marine Corps Base Hawai'i Installation Energy Plan |
| 17 | Dynamic Load Bank – Secure Micro-grids |
| 18 | Coconut Island DC Micro-grid |
| 19 | Load and PV Data Synthesis |
| 20 | Bi-directional EV Charging Demonstration Project |
| 21 | Advanced Conservation Voltage Reduction Development & Demonstration |
| 22 | Sustainable Grid Platform with Enhanced System Layer and Fully Scalable Integration |
| | |
| <u>Fuel Cell and Battery Technology</u> | |
| 23 | NELHA Hydrogen Station & Fuel Cell Electric Buses |
| 24 | Battery Energy Storage Systems Durability & Reliability |
| 25 | Path Dependence of Battery Degradation, EV Batteries for Grid Support |
| 26 | Water Purification with Ion Exchange Membrane and Porous Media |
| 27 | Fuel Cell Development for Electric Powered Unmanned Aerial Vehicles |
| 28 | Development of Magnesium Boride Etherates as Hydrogen Storage Materials |
| 29 | Development of Novel Air Filtration Materials |
| 30 | Active and Durable pgm-Free Catalysts for Fuel Cell Applications |
| 31 | Mass Transfer Analysis for High Power Fuel Cells |

| | |
|----------------------------------------------------|--------------------------------------------------------------------------|
| 32 | Proton Exchange Membrane Fuel Cell Contamination |
| 33 | Transition Metal Carbide Catalysts for Electrochemical Energy Storage |
| | |
| <u>Renewable Power Generation</u> | |
| 34 | Printable Photovoltaics |
| 35 | Research Support to the U.S. Navy Wave Energy Test Site |
| | |
| <u>Energy Efficiency and Transportation</u> | |
| 36 | Adaptive Lighting and Energy Efficient Security Strategy |
| 37 | Building Energy Reduction in Future Transit Oriented Development Areas |
| 38 | Ka Honua Momona: Maximizing Efficiency of Off-grid Nano-grid |
| 39 | Project FROG Net Zero, Mixed Mode Buildings |
| 40 | Electrified Transportation |
| | |
| <u>Hawai'i Energy Analysis and Policy</u> | |
| 41 | Technical and Decision Support Services to the Hawai'i PUC |
| 42 | Integrated Grid Planning Support |
| 43 | Hawai'i Energy Policy Forum |
| 44 | Energy Briefs |
| 45 | Grid Integration of Solar and Storage |
| 46 | Electric Vehicle Emissions Impacts in Hawai'i |
| | |
| <u>International Support</u> | |
| 47 | EGAT (Thailand) Renewable Integration Study |
| 48 | U.S. India Collaborative for Smart Distribution with Storage (UI-ASSIST) |
| 49 | Vietnam Low Emission Energy Program (V-LEEP) RPS Development |
| 50 | Field Verification of AI-based Microgrid (MG) |



Hawaii Natural Energy Institute Research Highlights

Alternative Fuels Solar Fuels Generation

OBJECTIVE AND SIGNIFICANCE: The objective of this research is to improve the durability and conversion efficiency of novel *chalcopyrite* thin-film photo-absorbers for photoelectrochemical (PEC) production of *solar fuels*, aiming for a \$2/kg production cost of renewable hydrogen.

BACKGROUND: Also referred as *Artificial Photosynthesis*, PEC technology combines advanced photovoltaic (PV) materials and catalysts into a single device that uses sunlight as the sole source of energy to split water into molecular hydrogen and oxygen. In a typical PEC setup, the solar absorber is fully immersed into an electrolyte solution and solar fuels are generated directly at its surface. Fuels produced with this method can be stored, distributed and finally recombined in a fuel cell to generate electricity, with water as the only byproduct.

In 2014, the team at HNEI’s Thin Films Laboratory teamed up with several National Laboratories (LLNL, LBNL and NREL) and mainland academic teams (Stanford, UNLV) to develop new semiconducting materials for PEC water splitting, with primary focus on *chalcopyrites*. This material class, typically identified by its most popular PV-grade alloy CuInGaSe_2 , provides exceptionally good candidates for PEC water splitting. A key asset of this thin-film semiconductor material class is its outstanding photo-conversion efficiency, as demonstrated with CuInGaSe_2 -based PV cells (>23%). In a PEC configuration, our group has demonstrated that chalcopyrite-based systems are also efficient at storing solar energy into hydrogen

bonds without the need of expensive precious catalysts [[link to HNEI paper](#)].

PROJECT STATUS/RESULTS: The HNEI’s Thin Films Laboratory is now combining theoretical modeling with state-of-the-art materials synthesis and advanced characterization capabilities to provide deeper understanding of *chalcopyrite*-based PEC materials and engineer high-performance devices. Our recent study demonstrates that alloying *chalcopyrites* with sulfur can improve light collection and increase their photo-conversion from 30% to 65% of the theoretical limit [[link to HNEI paper](#)]. Also, we recently demonstrated that a 3-5 nanometer thick metal oxide or sulfide layer can be used to effectively passivate *chalcopyrites* surface against photocorrosion, improving their durability from only few days to up to 6 weeks [[link to HNEI paper](#)]. Finally, we are investigating new device integration schemes involving thin-films *exfoliation* and bonding techniques to transfer chalcopyrite layers onto other solar absorbers to achieve more efficient water splitting devices [[link to HNEI paper](#)].

Funding Source: U.S. Department of Energy (EERE, FCTO)

Contact: Dr. Nicolas Gaillard, ngaillard@hawaii.edu, (808) 956 2342.

Last Updated: October 2019

Tandem PEC device concept

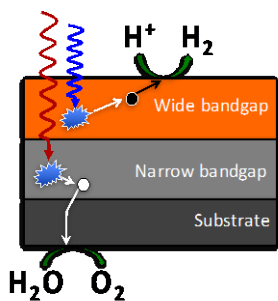

Bandgap tunable photoelectrodes

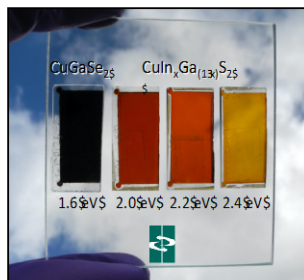

Transferable PEC layers for efficient devices

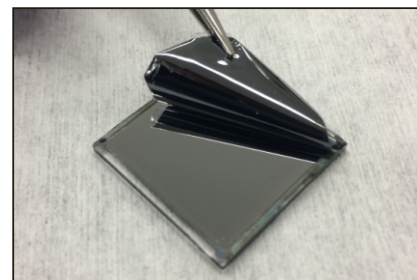



Hawaii Natural Energy Institute Research Highlights

Alternative Fuels

Sustainable Aviation Fuel Production

OBJECTIVE AND SIGNIFICANCE: Commercial aviation in Hawaii currently uses nearly 700 million gallons of jet fuel per year, all of it is derived from petroleum. The University of Hawaii is a member of the Federal Aviation Administration’s (FAA) Aviation Sustainability Center (ASCENT) team of U.S. universities conducting research on production of sustainable aviation fuels (SAF). The University of Hawaii’s specific objective is to conduct research that supports development of supply chains for alternative, renewable, sustainable, jet fuel production in Hawaii. Results may inform similar efforts in other tropical regions.

BACKGROUND: This project was initiated in October 2015 and is now continuing into its 5th year. Activities undertaken in support of SAF supply chain analysis include:

- conducting literature review of tropical biomass feedstocks and data relevant to their behavior in conversion systems for SAF production
- engaging stakeholders to identify and prioritize general SAF supply chain barriers (e.g. access to capital, land availability, etc.)
- developing geographic information system (GIS) based technical production estimates of SAF in Hawaii
- developing fundamental property data on biomass resources
- developing and evaluating regional supply chain scenarios for SAF production in Hawaii

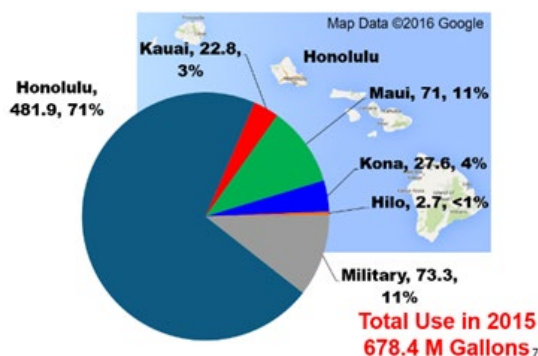

PROJECT STATUS/RESULTS: Literature reviews of both biomass feedstocks and their behavior in SAF conversion processes have been completed and published. Based on stakeholder input, barriers to SAF value chain development in Hawaii have been identified and reported. Technical estimates of land

resources that can support agricultural and forestry-based production of SAF feedstocks have been completed using geographic information systems analysis techniques. Samples from Honolulu’s urban waste streams and candidate agricultural and forestry feedstocks have been collected and subjected to physicochemical property analyses to inform technology selection and design of SAF production facilities.

Future work with ASCENT partners includes:

- Analysis of feedstock-conversion pathway efficiency, product slate (including co-products), maturation
- Scoping of techno-economic analysis (TEA) issues
- Screening level greenhouse gas (GHG) life cycle assessment (LCA)
- Identification of supply chain participants/partners
- Continued stakeholder engagement
- Acquiring transportation network and other regional data
- Evaluating infrastructure availability
- Evaluating feedstock availability

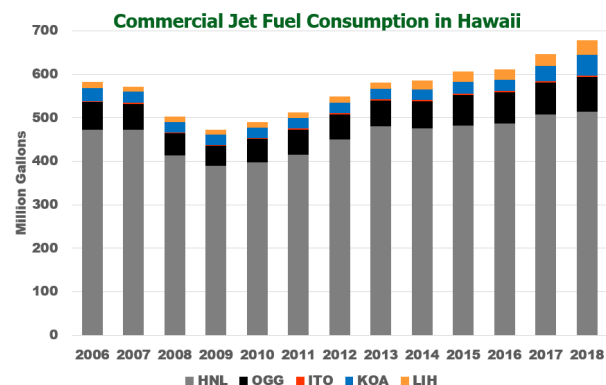

Funding Source: Federal Aviation Administration, and Hawaii’s Environmental Response, Energy, and Food Security Tax (HRS Section 243-3.5 “Barrel Tax”) through the Hawaii Natural Energy Institute’s Energy Systems Development Special Fund.

Contact: Scott Turn, sturn@hawaii.edu, (808) 956-2346

Last Updated: October 2019



Hawaii Natural Energy Institute Research Highlights

Alternative Fuels

Fuel Characterization by Multidimensional Gas Chromatography

OBJECTIVE AND SIGNIFICANCE: The objective of this project is to identify and characterize trace quantities of heteroatomic organic species (HOS) in aviation, maritime, and diesel fuels. New analytical methods under development can evaluate the composition of fuels currently in use and those stored as strategic reserves. The knowledge gained in this project will improve the understanding of the influences of HOS on fuel stability and guide efforts to preserve fuel quality.

BACKGROUND: Liquid fuels are, by nature, chemically complex and many fit-for-purpose and stability issues are associated with trace quantities of HOS. Identification and quantitation of HOS are challenging due to their low concentration and complex composition of fuel matrix. Multidimensional gas chromatography (MDGC) typically uses sequential separations based on differences in polarity and boiling point as the basis for fuel sample analysis. The current state-of-the-art for MDGC is comprehensive two-dimensional GC (2D-GC).

HNEI began developing a fuel laboratory in 2012 and the current capabilities include standard analysis methods required by ASTM and military fuel specifications. Research conducted in the fuel laboratory has included investigating the impacts of long-term storage, oxidative conditions, contaminants, etc. of conventional and alternative fuels and their blends.

A 2D-GC was acquired in August 2018, expanding the fuel laboratory's ability to identify and quantify fuel constituents present in trace amounts (≤ 100 ppm). The HNEI 2D-GC employs two injectors and three detectors (i.e. mass spectrometer, nitrogen chemiluminescence and sulfur chemiluminescence) to analyze fuel components and HOS with a single injection event. Neat fuels can be injected directly without requiring solvent dilution.

PROJECT STATUS/RESULTS: HNEI is currently collaborating with personnel from the US Navy Fuels Cross-Functional Team on 2D-GC applications, including:

- Determining fuel hydrocarbon matrix
- Investigating the distribution of nitrogen compounds in fuels
- Developing 2D-GC methods for characterizing sulfur containing compounds
- Establishing cross-laboratory 2D-GC methods
- Utilizing HOS characterization methods to investigate the potential impacts of HOS on fuel properties and fuel stability

Funding Source: Office of Naval Research (2012-present).

Contact: Scott Turn, sturn@hawaii.edu, (808) 956-2346; Jinxia Fu, jinxiafu@hawaii.edu, (808) 956-5944

Last Updated: October 2019

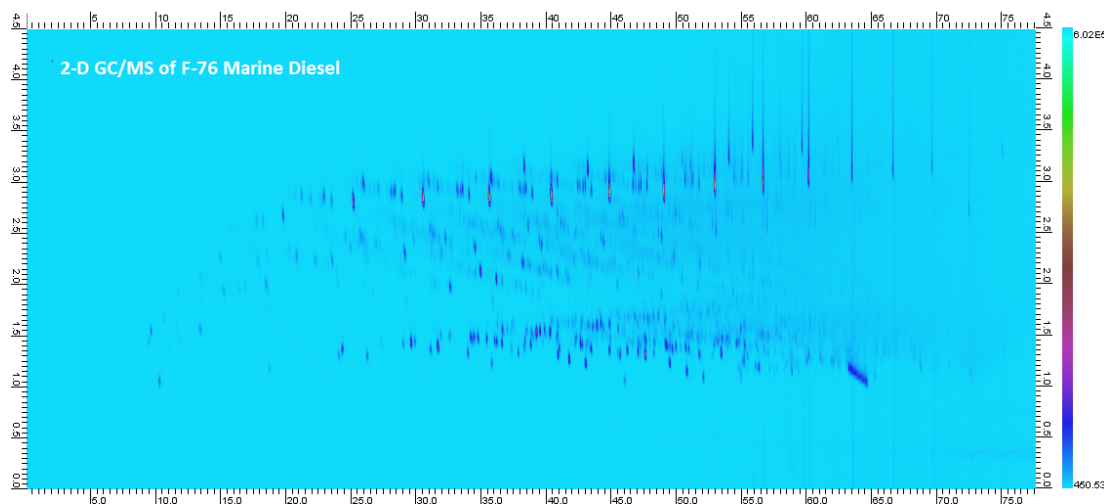



OBJECTIVE AND SIGNIFICANCE: The purpose of this project is to develop technologies to produce high-grade liquid fuel from synthesis gas derived from agricultural wastes. The drop-in liquid fuel can be directly used in modern engines of vehicles and ships without sacrifice of engine performance.

BACKGROUND: Agricultural wastes have a quite low heating value (HHV 15-18 MJ/kg) due to their high oxygen contents (40-50 wt%). The composition of raw biomass varies depending on plant species and farming conditions. It is a technological challenge to using diversified wastes as feedstock to produce high-grade liquid fuels that should meet the fuel standards of modern engines. The biomass wastes, however, can be gasified into simple synthesis gas that contains primarily carbon monoxide (CO), hydrogen (H₂) and carbon dioxide (CO₂). The new technologies produce polyhydroxybutyrate (PHB) from the gas by using an autotrophic microbial strain and then reform the PHB homopolymer into gasoline-grade liquid fuel.

PROJECT STATUS/RESULTS: The research investigated two core technologies: microbial gas fermentation and thermal catalytic reforming of PHB. Because of poor solubility of gas molecules in aqueous solution, a novel bioreactor was invented to increase the mass transfer rate of gas substrates in microbial fermentation. A high dry cell mass concentration (18 g/L) was obtained in a short period of time (72 hours). The productivity was about 15 times faster than a conventional microalgal culture. Under controlled conditions, the microbial cells formed large amounts of PHB (60% of cell mass) as an energy storage material. PHB was recovered and reformed on a solid acid catalyst under mild

conditions (<240 °C) to form a hydrocarbon oil. The major compounds of the PHB oil were alkanes, alkenes and aromatics, the same compounds found in gasoline and diesel. Depending on boiling points, the PHB oil was divided into a light oil (77 wt%) and a heavy oil (23 wt%). Their elemental compositions and heating values were determined and compared with commercial gasoline and biodiesel as shown in Table 1. The light oil has the same elemental composition and heating value of the gasoline obtained from a local gas station and the heavy oil is very close to a commercial biodiesel.

PHB is a homopolymer of 3-hydroxybutyrate (C₄H₅O₂) and contains a substantial amount of oxygen (38% wt). Oxygen removal is essential to generate hydrocarbon compounds for high heating value and desired fuel performance. The research identified the main reactions and key intermediates in the catalytic reforming of PHB. It was revealed that oxygen was removed as CO₂ without hydrogen consumption, a techno economic advantage in comparing with other biofuel technologies that consume large amounts of hydrogen.

The project has generated four reports, nine research and review articles in peer-reviewed scientific journals. One invention of novel bioreactor has been disclosed and filed for global patents.

Funding Source: Office of Naval Research, APRISES

Contact: Jian Yu, jianyu@hawaii.edu, (808) 956-5873

Last Updated: October 2019

Table 1. Comparison of PHB oils with commercial gasoline and biodiesel

| Liquid Fuels | Gasoline | Light PHB oil | Heavy PHB oil | Biodiesel |
|---------------------------|----------|---------------|---------------|-----------|
| Boiling Points (°C) | 40-200 | 40-240 | 240-310 | 180-330 |
| C (wt %) | 80.4 | 81.4 | 79.4 | 77 |
| H (wt %) | 12.3 | 11.3 | 9.7 | 11.8 |
| N (wt %) | 0.1 | 0.1 | 0.2 | - |
| O (wt %) | 7.2 | 7.2 | 10.7 | 11.2 |
| Heating Value (HHV MJ/kg) | 41.8 | 41.4 | 38.4 | 39.7 |



OBJECTIVE AND SIGNIFICANCE: The purpose of this project is to develop biorefinery technology to produce biochar-like solid fuel and environmentally friendly bioplastics from cellulosic biomass. The bioplastics have a much higher monetary value than solid fuel and hence can reduce the cost of solid fuel for power generation. The carbon-neutral solid fuel supplements solar and wind powers for grid management.

BACKGROUND: Cellulosic biomass from agriculture and forest management is an underutilized renewable source. The major components of raw biomass are cellulose (30-50% wt), hemicellulose (15-25% wt) and lignin (20-35% wt). Compared to lignite coal (\$20/ton), raw biomass is an expensive solid fuel (\$60/ton) and has a low heating value (HHV 17-19 MJ/kg) because of high atomic ratios of O/C and H/C of cellulose. However, cellulose is an inexpensive feedstock for high value products such as bioplastics.

PROJECT STATUS/RESULTS: The research investigated chemical and biological conversion of woody biomass. Under thermal catalytic hydrolysis conditions, wood sawdust was converted into a biochar like solid or hydrochar as shown in Figure 1. The cellulose in raw biomass was completely hydrolyzed and converted into organic acids, primarily levulinic and formic acids. Accounting for ca. 45% wt of raw biomass, the hydrochar solid has a heating value of lignite coal (HHV 25 MJ/kg), which is higher than raw or torrefied wood pellets. Since cellulose, hemicellulose and extractives were hydrolyzed and removed from raw biomass, the hydrochar is cleaner than raw biomass and has lower atomic ratios of O/C and H/C. The lignite-grade

hydrochar performs better than raw biomass in combustion. After a proprietary treatment and detoxification, the biomass hydrolysates, primarily organic acids, were utilized by a special microbial strain to form polyhydroxyalkanoates (PHA). The PHA bioplastics exhibit excellent ductility and have the same material properties of polyethylene and polypropylene for a variety of goods and applications. Importantly, the bioplastics can be completely utilized by microbes and degraded into water and carbon dioxide in the environment, providing a solution to plastic pollution in a circular economy.

According to the experimental results, 100 lbs of raw woody biomass (dry base) can be converted into ca. 45 lbs of lignite-grade solid fuel (\$0.03/lb) and 10 lbs of bioplastics (\$1-2/lb). The technology therefore increases the value of raw biomass by more than four folds. The bioplastics contribute a major portion of the value increase. As a result, the hydrochar is a carbon neutral solid fuel and competitive with lignite coal for power generation.

The project has generated four technical reports and three research articles in peer-reviewed scientific journals. A pilot project is in development to demonstrate the technology at scales of 1 kg to 100 kg of products from wood wastes.

Funding Source: Bio-on S.p.A. (2015-2020)

Contact: Jian Yu, jianyu@hawaii.edu, (808) 956-5873.

Last Updated: October 2019

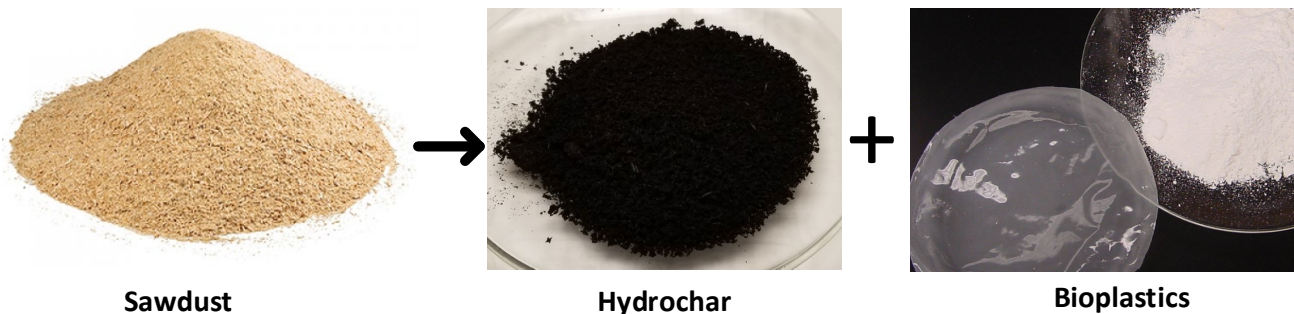

Figure 1. Conversion of wood sawdust into hydrochar and bioplastics



Hawaii Natural Energy Institute Research Highlights

Alternative Fuels

High Rate Anaerobic-Aerobic Digestion

OBJECTIVE AND SIGNIFICANCE: To produce a master design, inclusive of PID diagrams, costing, manufacturing, and shipping to build and install a wastewater treatment system designed from past research and commercial demonstration projects. Its importance lies in its commercial scale modular-based designed. The system fits niche opportunities where concentrated wastewater streams need to be treated on-site prior to discharge to pre-existing wastewater lines. The modular nature allows non-concrete permanent installations that can be tailored to specific wastewater flows and concentration of pollutants.

BACKGROUND: Over a number of years an up-flow anaerobic packed bed reactor was developed. Packed with biochar in various formulations, these reactors were verified at lab and demonstration scale to treat high and low strength wastewaters efficiently. These exercises served to verify lab generated results upon scale up to commercial size, and to provide crucial insights for design revision as well as experience for discussion with manufacturers as well as equipment selection.



From this work PID diagrams have been constructed that have considered targeted organic loading rates and hydraulic retention times. These designs are accounting for modular fabrication of reactor units, dimensions of reactors and pipes, piping size, recycle lines, details of how to install and connect modules, utilities and electrical, materials of construction, sources of manufacturing, packing materials, shipping and installation issues, among others. Finally, cost

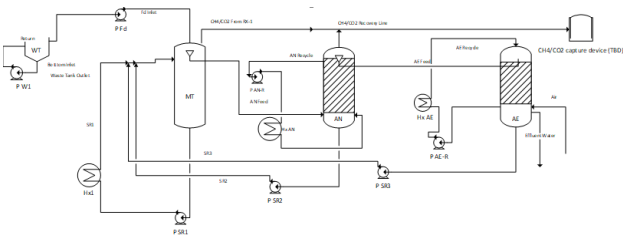

estimates for fabrication, shipping, and installation were estimated and three-dimensional renderings were generated.

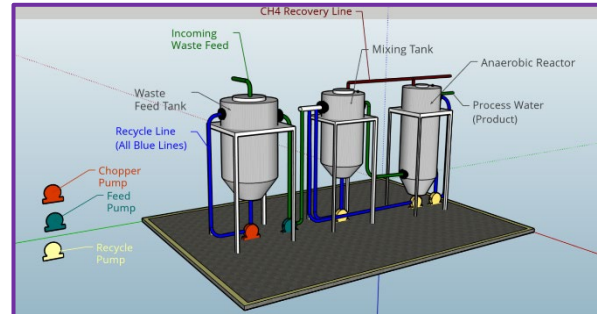

| | Table 1 | High Carbon Feed | Low Carbon Feed |
|------------|-----------------------|---------------------|---------------------|
| Subsystems | Tanks/Reactor Vessels | \$126,000.00 | \$126,000.00 |
| | Pumps | \$67,742.50 | \$71,000.00 |
| | Sensors and Heaters | \$30,661.20 | \$30,661.20 |
| | Total | \$224,403.70 | \$227,661.20 |

PROJECT STATUS/RESULTS: The PI is seeking industrial partners to apply system.

2018 Cooney, M. J., Lamichhane, K. and K. Rong. Cross comparative analysis of liquid phase anaerobic digesters. *Journal of Water Research*. Available on-line. *Journal of Water Process Engineering*.

2017 Lamichhane, K, Lewis, K., Rong, K., Babcock, R., and M. J. Cooney. *SHORT COMMUNICATION: Treatment of high strength acidic wastewater using passive pH control*. *Journal of Water Process Engineering*. 18:198-201.

2017 Lamichhane, K., Furukawa, D., and M. J. Cooney. *Co-digestion of glycerol with municipal wastewater*. *Journal of Chemical Engineering & Process Technology*. 3(1): 1034.

2016 Cooney, M. J., D. Harris, K. Lewis, and Tao Yan. *Startup performance of biochar packed bed anaerobic digesters*. *Journal of Water Process Engineering*. 9:e7-e13.

Funding Source: Office of Naval Research, APRISES

Contact: Michael J. Cooney, mcooney@hawaii.edu, (808) 956-7337

Last Updated: October 2019



Hawaii Natural Energy Institute Research Highlights

Alternative Fuels Methane Hydrates

OBJECTIVES AND SIGNIFICANCE: Methane hydrates in deep ocean sediments and arctic permafrost constitute an enormous energy reservoir that is estimated to exceed the energy content of all known coal, oil, and conventional natural gas resources. The primary goals of this project that has been ongoing since 2001 are 1) to support exploration of hydrate reservoirs in seafloor sediments and arctic permafrost; 2) to support the development of safe and practicable methods to destabilize hydrates to produce methane fuel; and 3) to advance our understanding of the environmental impacts of natural seeps and accidental releases of methane and other hydrocarbons in the ocean. In addition, HNEI has also investigated engineering applications of hydrates including desalination and H₂ storage, and promoted many international R&D collaborations.

BACKGROUND: Research on CO₂ hydrates at HNEI began in the early 1990's as part of an international collaboration on CO₂ ocean sequestration. Our research scope expanded to include methane hydrates around 1999 when HNEI was asked by the Minerals Management Service (MMS) of the Department of the Interior to participate in a study on deep oil spills. Over time, we have conducted a host of laboratory investigations on a wide range of topics related to hydrates and participated in numerous oceanographic research cruises to offshore hydrate zones.

At present, our activities are focused on the following three areas: 1) chemical destabilization of hydrates; 2) biogeochemistry of seafloor methane hydrates and the biodegradation of methane in the ocean; and 3) promoting international research collaborations and information exchanges.

Methane hydrates can be destabilized by application of heat, depressurization, or contact with chemical reagents known as thermodynamic inhibitors. Destabilization results in melting of the solid hydrate, which releases liquid water and methane gas. Many conventional inhibitors are expensive and/or toxic. Our laboratory experiments evaluate the effectiveness of various inhibitors with the goal of identifying safe and inexpensive alternatives. Figure 1 shows a novel facility developed by HNEI researchers to investigate the thermochemistry of hydrates. This facility employs a fiberoptic probe coupled into a high

pressure calorimetry test cell to permit Raman spectra to be sampled as hydrates form and decompose. The Raman calorimeter has provided valuable data to assess inhibitor effectiveness.



Figure 1. Photo of the Raman calorimetry facility.

PROJECT STATUS/RESULTS: This project is ongoing. Key results of recent work include: completed an analysis of seismic data of hydrate reservoirs in the Nankai Trough offshore of Japan; determined the effectiveness of alternative inhibitors such as salts that occur naturally in seawater and glycerol to dissociate hydrates; evaluated the feasibility of hydrogen storage using hydrates; and identified novel marine microbes that degrade hydrocarbons. Details of this research can be found in the publications listed below.

Weissman, J.T. and S.M. Masutani. 2017. Hydrogen storage capacity of tetrahydrofuran and tetra-*n*-butylammonium bromide hydrates under favorable thermodynamic conditions. *Energies* 10(8). 1225. doi:10.3390/en10081225.

Taladay, K., B. Boston and G.E. Moore. 2017. Gas-in-place estimate for potential gas hydrate concentrated zone in the Kumano Basin, Nankai Trough Forearc, Japan. *Energies* 10(10), 152. doi: 10.3390/en10101552.

Sylva, T.Y., C.K. Kinoshita, and S.M. Masutani. 2016. Inhibiting effects of transition metal salts on methane hydrate stability. *Chem. Eng. Sci.* 155 doi: 10.1016/j.ces.2016.06.028.

Ching T.H., B.A. Yoza, R. Wang, S. Masutani, S. Donachie, L. Hihara and Q. Li. 2016. Biodegradation of biodiesel and microbiologically induced corrosion by *Moniliella* sp. Y12. *Intern. Biodeter. Biodegrad.* 108; 122.

Funding Source: Office of Naval Research, APRISES

Contact: Stephen Masutani, stephenm@hawaii.edu, (808) 956-7388

Last Updated: October 2019



OBJECTIVE AND SIGNIFICANCE: Japan has begun offshore pre-production activities to recover methane gas from hydrate reservoirs in seafloor sediments south of Tokyo. Prior to commercial production, the associated environmental consequences need to be carefully assessed. HNEI was contracted to employ its unique laboratory-scale deep ocean simulator facility to measure the dissolution rate and hydrodynamic behavior of methane bubbles at conditions in the ocean down to 1000 m depth. These data will be employed for model development by colleagues in Japan to predict possible impacts to the marine environment near production sites.

BACKGROUND: Methane hydrate (MH) in deep ocean sediments represents one of the few conventional (i.e., fossil) energy resources found in Japan. Japan has led the world in R&D investments in MH exploration and science. In 2013, a Japanese consortium conducted the world’s first offshore MH gas production test in the Eastern Nankai Trough at a water depth of about 1000 m. A hydrate reservoir located 200-300 m below the seafloor was depressurized, causing the hydrate to decompose into its constituent methane gas and water components. The released gas flowed through a conduit to the ocean surface. A 2nd longer duration test was performed in 2017 at a location near the 2013 site. A recent HNEI publication summarizes Japan’s MH R&D activities and strategy in the context of the country’s overall energy policy (Oyama, A. & S.M. Masutani, 2017. A review of the methane hydrate program in Japan. *Energies* 10(10) <https://doi.org/10.3390/en10101447>; open access download: <https://www.mdpi.com/1996-1073/10/10/1447>).

As part of HNEI’s past CO₂ ocean sequestration and deep oil spills research activities, and its ongoing MH program, we have developed unique laboratory facilities to simulate conditions in the deep ocean. In late 2018, Japan NUS Co., Ltd., with funding from METI, contracted HNEI to conduct experiments in our facilities to investigate the behavior of rising, buoyant methane bubbles released in the deep ocean as a consequence of gas production activities.

Figure 1 presents a schematic diagram of the high-pressure water tunnel system employed in the present study. The clear acrylic test section (gray insert in the

figure) is enclosed in the vessel shown in Figure 2, which is filled with chilled synthetic seawater pressurized to approximate conditions in the ocean at depths down to 1000 m. The steady downward flow of seawater pumped through the water tunnel can be adjusted to exactly offset the buoyancy of a methane bubble in the test section so that the bubble stays fixed in space and can be observed with a video camera. The rate of shrinkage of the bubble can then be used to determine dissolution rates of the methane into seawater under dynamic condition similar to those experienced by bubbles rising in the ocean.

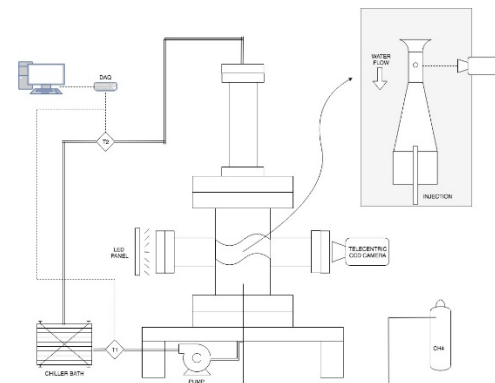

Figure 1. Schematic diagram of the water tunnel.

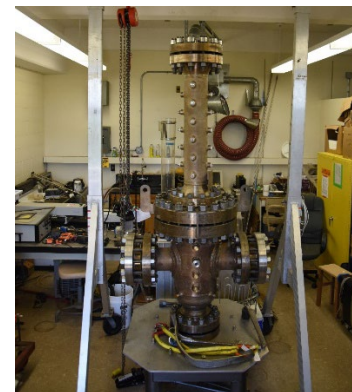

Figure 2. Photograph of the deep ocean simulator.

PROJECT STATUS/RESULTS: This project was completed in 2019 and results currently are under review by the funding agency.

Funding Source: Japan NUS Co., Ltd. (JANUS)

Contact: Brandon Yoza, byoza@hawaii.edu, (808) 956-6137; Stephen Masutani, stephenm@hawaii.edu, (808) 956-7388

Last Updated: October 2019



OBJECTIVE AND SIGNIFICANCE: The primary objectives of this study are to identify aquatic microbes that effectively degrade hydrocarbon pollutants in estuaries and the ocean, and to elucidate the mechanisms of this degradation. This information is vital to understand and assess the extent of the environment impacts of oil and gas discharges and to develop novel strategies to mitigate these impacts.

BACKGROUND: This project is an adjunct to the APRISES Methane Hydrates Task. Purposeful (e.g., for natural gas recovery) or accidental destabilization of seafloor hydrates will release methane into the oceanic water column. In addition, many commercial and DoD activities result in hydrocarbon contamination of the ocean and estuarine environments. Under these types of scenarios, bacterial and fungal communities in the water are known to play a key role in ameliorating the impacts of the polluting hydrocarbons species.

Laboratory experiments have been conducted to identify microbes that can metabolize and remove hydrocarbon contaminants from aquatic environments and to investigate the key pathways and mechanisms of this process. Figure 1 is a microscope photograph of a species of fungus found in Hawaii that can degrade hydrocarbons which was isolated and identified in this study.

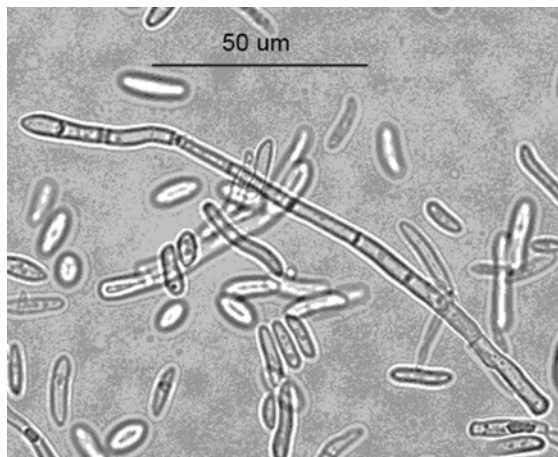

Figure 1. *Moniliella wahieum* (ATCC MYA-4962) a hydrocarbon degrading fungus that has been isolated and characterized in Hawaii.

PROJECT STATUS/RESULTS: This project is ongoing. Recent results are available in the following peer-reviewed publications:

1. Ye C., Ching T.H., Yoza B.A.*, Masutani S.M., Li Q.X. 2017. Cometabolic degradation of blended biodiesel by *Moniliella wahieum* and *Byssoschlamys nivea* M1. *Intern. Biodeter. Biodegrad.* 125; 166-169
2. Chen C., Liang J., Yoza B.A., Yao X., Li Q.X., Wang Q. 2017. Evaluation of an up-flow anaerobic sludge bed (UASB) reactor containing diatomite and maifanite for the improved treatment of petroleum wastewater. *Biores. Techn.* 243; 620-627
3. Zhan Y., Wang Q., Chen C., Kim J.B., Zhang H., Yoza B., Li Q.X. 2017. Potential of wheat bran to promote indigenous microbial enhanced oil recovery. *Journal of Industrial Microbiology and Biotechnology.* 44(6); 845-855
4. Chen C., Wang J., Kim J.B., Wang Q.H, Wang J., Yoza B., Li Q.X., Guo S. 2016. Laboratory studies of rice bran as a carbon source to stimulate indigenous microorganisms in oil reservoirs. *Petroleum Science* 13(3); 572-583
5. Ching T.H., Yoza B.A.*, Wang R., Masutani S., Donachie S., Hihara L. and Li Q. 2016. Biodegradation of biodiesel and microbiologically induced corrosion by *Moniliella sp.* Y12. *Intern. Biodeter. Biodegrad.* 108; 122-126
6. Coffin R.B., Hamdan L.J., Plummer R.E., Millholland L.C., Smith J.P., Yoza B.A., Larsen R.K., Montgomery M.T. 2013. Spatial variation in shallow sediment methane source and cycling along the Alaskan Beaufort Sea. *Marine and Petroleum Geology.* 45: 186-197
7. Harada R.M., Yoza, B.A., Masutani S.M., Li Q.X. 2013. Diversity of Archaea communities within contaminated sand samples from Johnston Atoll. *Bioremediation Journal*, 17(3): 182-189

Funding Source: Office of Naval Research, APRISES

Contact: Brandon Yoza, byoza@hawaii.edu, (808) 956-6137; Stephen Masutani, stephenm@hawaii.edu, (808) 956-7388

Last Updated: October 2019



OBJECTIVE AND SIGNIFICANCE: Seafloor seeps of natural gas (comprising primarily methane) exist at many locations throughout the world. These seeps have the potential to provide *in situ* power for a host of scientific and military marine applications, such as bottom-mounted oceanographic instrumentation, surveillance equipment, and recharging stations for autonomous underwater vehicles (AUVs). In cooperation with Makai Ocean Engineering (MOE), HNEI is conducting a study to identify robust, practicable systems to harvest fuel methane from seafloor seeps and convert it to electrical power; and to develop a conceptual design of the best candidate system(s) for a 1 kW subsea AUV charging station based on the results of this study. If successful, then this novel approach to subsea power generation would greatly expand our ability to explore the deep oceans.

BACKGROUND: Between 2005 and 2006, HNEI performed a feasibility analysis of utilizing seafloor methane—either from gas seeps or solid methane hydrates—for power generation applications. The results of that study are available in a Final Report to DARPA (“Subsea Power Generation Systems Utilizing Seafloor Methane,” Final Technical Report, Defense Advanced Research Project Agency Grant No. HR0011-05-1-0039, 2006). Figure 1 below, taken from the 2006 Final Technical Report, provides a sketch of a proposed AUV recharging station that uses surface deposits of methane hydrate as fuel.

DARPA subsequently suspended its program on seafloor power sources until 2018 when an RFP was issued on this topic. MOE, a private company based in Honolulu, HI, responded to that RFP and was awarded an STTR grant in December 2018. HNEI has been subcontracted by MOE to collaborate on this study since it can leverage the technical resources and expertise developed during the earlier project.

PROJECT STATUS/RESULTS: This research activity was initiated at HNEI in July 2019. HNEI engineers have been providing technical support to MOE on key technologies including fuel gas reforming, gas purification, fuel cell performance, and system engineering. HNEI also is working closely with MOE to prepare a proposal for a Phase 2 STTR project in which field testing of a prototype will be undertaken. Results of the Phase 1 investigation will be reported at a later date, following review by DARPA.

Funding Source: DARPA via Makai Ocean Engineering

Contact: Stephen Masutani, stephenm@hawaii.edu, (808) 956-7388; Scott Turn, sturn@hawaii.edu, (808) 956-2346

Last Updated: October 2019

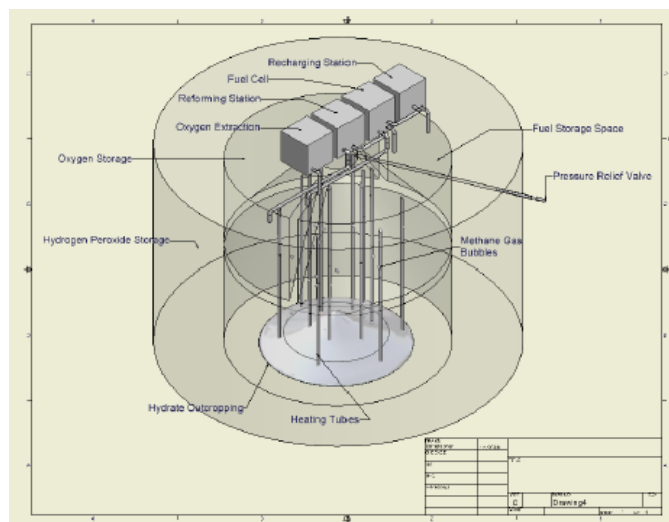

Figure 1. Sketch of seafloor AUV recharging system.



Hawaii Natural Energy Institute Research Highlights

Grid Integration

Advanced Power System Laboratory (APSL)

OBJECTIVE AND SIGNIFICANCE: HNEI GridSTART is designing and equipping its new Advanced Power System Laboratory (APSL) to conduct research, development, testing and evaluation (RDT&E) in support of power systems modernization and renewable energy integration. APSL has a highly flexible architecture and is the first laboratory of its kind in Hawaii — able to test AC and DC devices, systems, and microgrids within a managed field representative electrical environment. The lab will significantly enhance HNEI’s active research program by providing a state-of-the-art test environment that extends its RDT&E capabilities to deliver next-generation smart grid technologies.

BACKGROUND: Major elements of the new laboratory include three (3) AC/DC equipment test bays and a 35 kW rooftop PV system connected to four (4) advanced PV inverters capable of grid support functions. The PV system serves two purposes; the lab’s research needs, and aiding the University of Hawaii achieve its goal of net zero energy consumption. The lab also hosts a real-time grid simulator connected to a 30 kVA power amplifier which provide power hardware-in-the-loop (PHIL) testing capabilities. The PHIL system enables researchers to evaluate electrical power equipment as a unit under test (UUT) in a real-time simulated grid environment. Figure 1 illustrates the main components of the lab architecture.

The three (3) modular AC/DC test bays will be used to evaluate advanced functions, communications and controls of various UUT such as advanced PV inverters; EV chargers, including those enabled for

vehicle-to-grid (V2G) and vehicle-to-home (V2H) bi-directional power flow; battery energy storage systems (BESS); power monitoring and edge computing devices; AC or DC loads/appliances and load control devices; and voltage management equipment; among other novel technology solutions.

PROJECT STATUS/RESULTS: Major elements of the laboratory have been procured (e.g., 35 kW rooftop PV system and inverters, PHIL system, workbenches and other benchtop electrical test equipment) and are already in limited use by GridSTART personnel conducting RDT&E activities. A highly-qualified electrical design engineering firm and an experienced electrical lab safety consultant were both retained to deliver the final lab design drawings in a form that ensures the facilities, when complete will fully meet our RDT&E objectives with “safety first” considerations embedded in the lab architecture, infrastructure, layout, equipment and its use. The electrical safety consultant is further tasked to develop all appropriate lab safety administrative controls and safe work practices guidelines, templates and the like. The APSL is targeted for full operation in mid-2020.

Funding Source: Office of Naval Research, APRISES

Contact:

Leon Roose, lroose@hawaii.edu, (808) 956-2331;
Kevin Davies, kdavies@hawaii.edu, (808) 956-3180;
Silas Toledo, silasodt@hawaii.edu, (808) 956-8073

Last Updated: November 2019

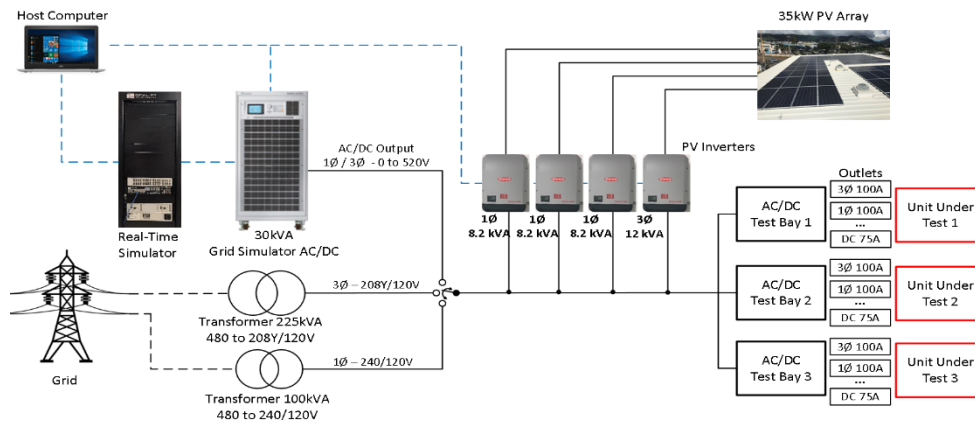

Figure 1. HNEI GridSTART’s Advanced Power System Lab architecture



Hawaii Natural Energy Institute Research Highlights

Grid Integration

Advanced Real-Time Grid Energy Monitor System (ARGEMS)

OBJECTIVE AND SIGNIFICANCE: The objective of this project is to develop a low-cost device and system that can provide enhanced situational awareness and tighter, localized coordination of distributed energy resources (DERs) such as rooftop solar photovoltaics (PV). This is important for Hawaii in meeting its renewable portfolio standards (RPS) targets because as power generation and ancillary services become more decentralized and variable, there is a critical need for enhanced measurement, data analytics, and distributed controls near the grid edge. Field devices such as advanced meters, line sensors and secondary var controllers are all part of Hawaiian Electric Companies' Grid Modernization Strategy, and this project has the potential to provide significant advancements in these areas beyond the commercial state of the art.

BACKGROUND: Grid edge technology has the potential to relieve voltage constraints with local context-aware reactive power control, identify and help mitigate local thermal violations through non-wires alternatives, provide data for more refined and readily updated PV hosting capacity analysis, identify power quality issues such as harmonic distortion from increasing amounts of power electronic devices, and assist in fault location and anomaly detection, such as pending transformer failure and unmetered loads. This device offers a high-tech, flexible research-to-commercialization platform that can be programmed to support these use cases and more. It offers high-fidelity voltage and current measurement, numerous communications options, low-latency messaging, GPS, backup power supply, and powerful processing capabilities for real-time data analysis, all within a small weather resistant enclosure.

PROJECT STATUS/RESULTS: Devices have been successfully deployed for up to two years on the UH campus, at Arizona State University, and in Okinawa Japan; testing and demonstrations have also been performed in Alaska. HNEI is discussing field demonstrations with the Hawaiian Electric Company (HECO), Chulalongkorn University and the Provincial Electricity Authority (Thailand), and the US Navy Engineering and Expeditionary Warfare Center.

The system is currently patent pending (through UH Office of Technology Transfer), and commercial pathways are currently being explored. Costs are on track to be competitive with traditional distribution service transformer monitors. New research collaborations have been fostered as a result of the project, and the system has been featured in numerous funding proposals. Thirteen undergraduate students have been involved with the project. It has been shared with the public through ThinkTech Hawaii, SOEST Open House, Voices of the Sea (upcoming), and a high school student STEM mentorship. Two journal articles are in preparation on the development, performance, and applications of the system including distributed controls.

Web Link:
<https://www.hnei.hawaii.edu/projects/argems>

Funding Source: Office of Naval Research (APRISSES, APRESA), Defense University Research-to-Adoption (DURA) via Arizona State University

Contact: Kevin Davies, kdavies@hawaii.edu
 (808) 956-3180

Last Updated: November 2019

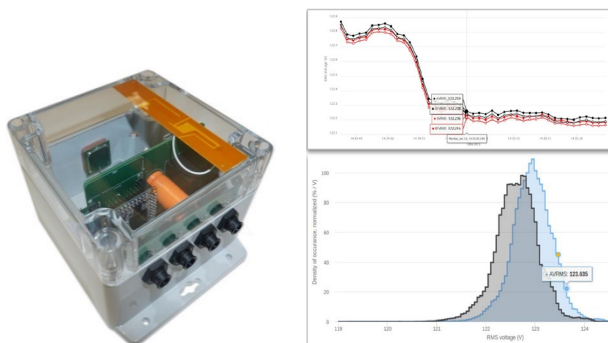

Figure 1. ARGEMS device and examples of web interface



Hawaii Natural Energy Institute Research Highlights

Fuel Cell & Battery Technology

Molokai Electric Grid Aided by Fast Battery Energy Storage System

OBJECTIVE AND SIGNIFICANCE: A speed-enhanced Battery Energy Storage System (BESS) was installed on the island of Molokai to limit electric grid contingencies and outages arising from high penetration levels of distributed photovoltaic (PV) installations. The novel speed enhancement made the BESS suitable for stabilizing a low inertia grid, like Molokai.

BACKGROUND: Before rooftop PV, the Molokai electric grid demand was supplied by diesel generators. These generators have a natural inertia that limits the consequences of fast imbalances between generation and load. Fast-forward to today: 2 MW of the 5 MW of generation are displaced by PV systems, which have no inertia. So, the consequences of grid events (such as short circuits) can easily cause PV to trip which can cascade into blackouts.

BESS's can provide fast responses to mitigate the effects of reduced inertia. To investigate this, HNEI procured a 2 MW, 397 kW-Hr BESS from Altairnano Inc. which consists of a Power Module (PM) containing all the batteries, and a Power Conditioning System (PCS), which is the inverter manufactured by Parker-Hannifin Inc. In compliance with a memorandum of agreement, ownership of the BESS was turned over to Maui Electric (the Molokai grid utility owner) after commissioning with an understanding that grid data would be made available for research purposes.

An early finding of this investigation showed that the full response time of the BESS would likely destabilize the grid rather than improve it. A review of the real-time data measurement and processing architecture showed that the time between a measurement and a corresponding BESS response would be about 350 ms. Simulation and modeling showed that a response time of about 50 ms was required to maintain stability.

With this finding, an effort was launched to reduce the response time by having the PCS make direct measurements rather than await commands from the PM computer. This effort reduced the response time to about 58 ms (typical). Live grid testing revealed that this response time was sufficiently short, and that the BESS was able to limit grid contingencies.

PROJECT STATUS/RESULTS: The figure below shows the daily extreme grid frequencies (which can be associated with contingencies). Many PV systems currently installed on Molokai can trip when the frequencies are above 60.5 Hz or below 59.7 Hz. The upper limit was very close to being breached on a daily basis before the BESS was commissioned (black line) and reduced after commissioning (red line). Enhancements to the BESS will be tested in the next two years.

Funding Source: Office of Naval Research, APRISES
Contact: Marc Matsuura, marcmm@hawaii.edu, (808) 956-5070
Last Updated: October 2019

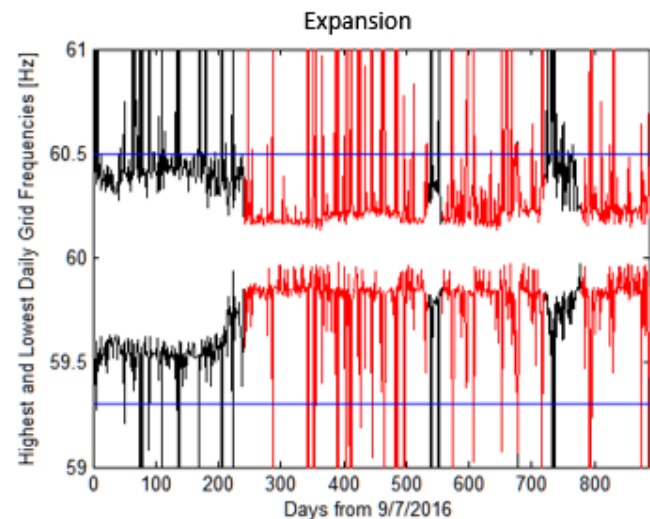
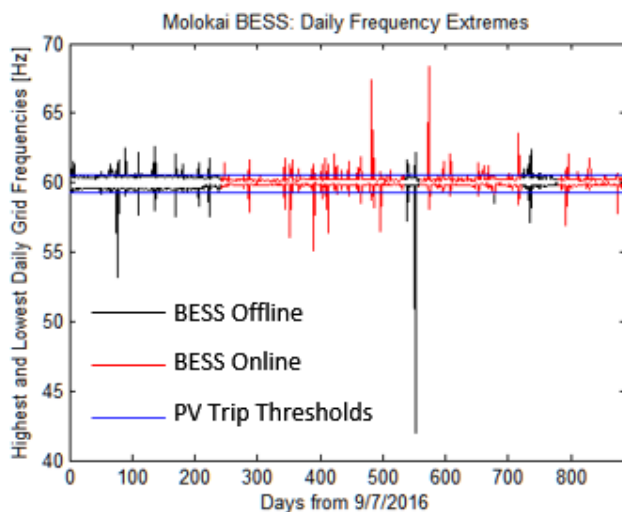



Hawaii Natural Energy Institute Research Highlights

Grid Integration

Solar Power Forecasting

OBJECTIVE AND SIGNIFICANCE: The project objective is to develop and employ advanced forecasting methods and technologies to predict solar photovoltaic (PV) power generation from minutes to days ahead. Knowledge of PV system future output allows grid operators and grid management systems to proactively address the inherent variability of solar power. Day ahead (DA) forecasts support unit planning and scheduling, while hour ahead (HA) forecasts support unit dispatch and operational reserve management, and minute ahead (MA) forecasts predict the timing and magnitude of significant PV ramp events. Solar forecasts also provide visibility and situational awareness for distributed behind the meter solar systems, helping to minimize reliability issues and disruptive events, and manage the cost of grid operations with increasing levels of PV interconnected to the electric grid.

BACKGROUND: Power output from PV systems is directly related to the power of the sunlight striking the panel, measured as irradiance. Solar irradiance at the top of the atmosphere varies slowly and predictably, modulated by Sun-Earth geometry and solar variability. Solar irradiance at ground-level varies quickly and erratically, modulated by the absorption and scattering of sunlight by clouds, fog and haze, as well as other particulates, such as dust, ash, and smog. The state of these particles is controlled by complex, nonlinear, and dynamic atmospheric processes, which makes PV power output in most cases highly variable and difficult to predict.

HNEI has developed a multi-scale, solar forecasting system capable of monitoring irradiance in near real-time and generating PV power forecasts from minutes to days ahead. This system is fully automated, generating predictions without human intervention. For irradiance forecasts longer than 6 hours ahead, numerical weather prediction (NWP) models are required to account for turbulent atmospheric processes. DA forecasts are generated from a specific configuration and augmentation of the Weather Research and Forecasting (WRF) system designed for solar energy applications. HA and MA forecasts are generated using advection and diffusion models driven by satellite and ground based observations.

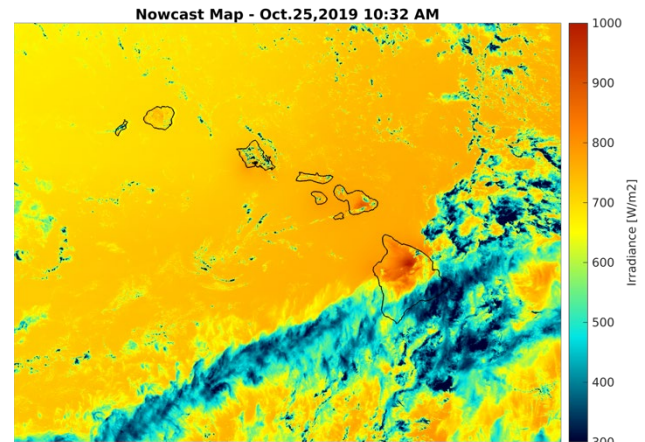

Figure 1. Example irradiance map from GOES-17 imagery.

Using geostationary satellite imagery, HNEI has developed low-latency solar mapping and prediction algorithms capable of generating regional, near real-time irradiance nowcasts and 6-hour ahead forecasts. HNEI has also developed an irradiance mapping and prediction instrument for high-resolution irradiance nowcasts and MA forecasting. The instrument is designed for low production cost, wireless operation, edge computing functionality, and self-monitoring. Power predictions are generated using these irradiance predictions and a PV simulation model. Power output can be predicted for a large number of distributed solar systems with varying orientations, as long as basic metadata is accessible.

PROJECT STATUS/RESULTS: The HNEI solar forecasting system, designed in Hawaii, is generating operational DA and HA forecasts for the populated Hawaiian islands. The Hawaii-based system was recently updated to use the GOES-17 satellite, which replaced GOES-WEST operations in early 2019. In collaboration with the Korea Electrotechnology Institute (KERI), HNEI has now extended its forecasting system to generate DA and HA forecasts for South Korea, using the Himawari-8 satellite.

Funding Source: Office of Naval Research (APRISSES, APRESA); KERI; U.S. Department of Energy (UI-ASSIST).

Contact: Dax Matthews, daxm@hawaii.edu, (808) 956-8087

Last Updated: November 2019



Hawaii Natural Energy Institute Research Highlights

Grid Integration/Secure Microgrids

NELHA HOST Park Microgrid Analysis

OBJECTIVE AND SIGNIFICANCE: The primary objective of HNEI GridSTART’s proposed work is to conduct an analysis to determine the feasibility and benefits of modifying the current energy system at NELHA’s Hawaii Ocean Science and Technology Park (“HOST Park”) to enable it to operate as a microgrid (or a number of microgrids), connected to the Hawaii Electric Light Company (HELCO) electric grid system, or as a stand-alone facility. Figure 1 depicts NELHA’s HOST Park and the existing HELCO distribution feeder that provides electrical service to the site. The study will determine those distribution system configurations providing optimal benefit to NELHA, to the HELCO grid, and to both together. A secondary objective is to maximize use of renewable energy resources available within the HOST Park.

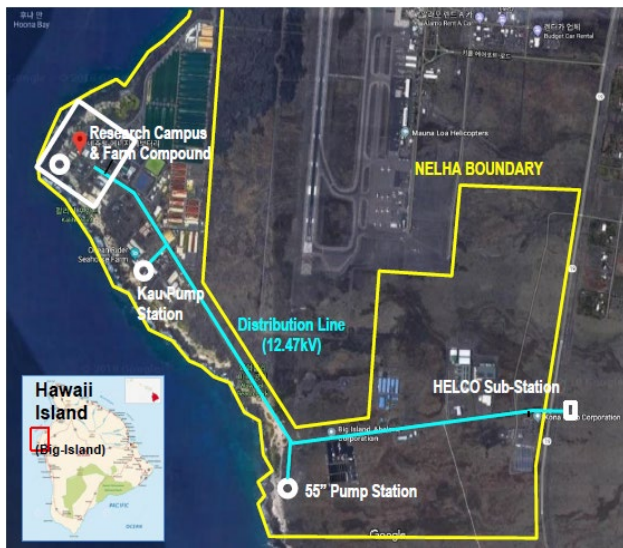

Figure 1. NELHA’s HOST Park site and existing HELCO service distribution feeder.

BACKGROUND: Microgrids, especially those focused on the integration of renewable energy sources, are of interest in Hawaii for their potential to enhance reliability of the microgrid site and host grid, to increase energy assurance, improve security, and potentially reduce cost and carbon footprint. Microgrids can also improve resilience against both manmade and natural disruptions.

The Governor of Hawaii signed Act 200 which directed the Hawaii Public Utilities Commission (“PUC”) to open a proceeding to establish a microgrid services tariff to encourage and facilitate the development and use of microgrids throughout the State. NELHA’s HOST Park facility has been identified by the PUC as a potential demonstration site for advanced technologies to enable grid resiliency through microgrid development. As a part of its analysis, GridSTART will identify regulatory and policy issues currently in place that hinder development of such microgrids and offer modifications to those regulations and policies for future action.

To achieve the overall project objectives, a power system requirements analysis of the HOST Park based on NELHA’s energy projections for a 10-year period will be conducted. Both the technical and regulatory/policy opportunities and barriers will then be assessed, with potential on-site distributed generation, energy storage, power management, and control technology alternatives evaluated to identify the most promising ones applicable to a microgrid at the NELHA HOST Park. Current Hawaii regulations and policies likely to impact development of an integrated microgrid serving the HOST Park will be assessed. The work will deliver microgrid power system conceptual design options that meet NELHA’s technical and economic power requirements over the 10-year planning horizon.

PROJECT STATUS/RESULTS:

- Developed detailed project plan and schedule
- Currently working with NELHA to gather HOST Park infrastructure, load, and generation data

Funding Source: Hawaii State Energy Office

Contact: Leon Roose, lroose@hawaii.edu, (808) 956-2331

Last Updated: November 2019



Hawaii Natural Energy Institute Research Highlights

Grid Integration

Marine Corps Base Hawaii Installation Energy Plan

OBJECTIVE AND SIGNIFICANCE: HNEI Grid**START** is supporting the Marine Corps Base Hawaii (MCBH) in completing its Installation Energy Plan (IEP) to enhance installation energy resilience and improve mission assurance. The IEP will document the current and future energy security requirements of MCBH, its ability to meet those requirements and plans to address high priority gaps. It will take into account resource constraints, statutory mandates, executive policy and service-level priorities.



Figure 1. Marine Corps Base Hawaii at Kaneohe Bay (Source: <https://www.mcbhawaii.marines.mil>)

BACKGROUND: On May 30, 2018, the Office of the Assistant Secretary of Defense Energy, Installations, and Environment (OASD-EI&E) issued the memorandum “Installation Energy Plans – Energy Resilience and Cybersecurity Update and Expansion of the Requirement to All DoD Installations,” requiring all military installations to develop an IEP.

The IEP will take into account the capacity, reliability, and condition of the existing energy infrastructure on base and the ability to meet future

growth requirements. The plan will define the critical facilities requirements to meet energy resilience objectives and will be coordinated with Installation Protection’s (IP) Mission Assurance Assessment (MAA), Energy Security Assessment (ESA), and Continuity of Operation Program (COOP) plans and requirements.

The IEP is envisioned to discuss, compare and contrast alternatives for energy security and resiliency, and recommend technical strategies and solutions. The solutions are to be based upon technologies that are already proven commercially viable and ready-to-go. It is intended to deliver an actionable energy plan for MCBH with a focus on economical and resilient energy systems ready for implementation. IEP development will require close cooperation between HNEI and MCBH stakeholders through regular interaction and exchange to secure necessary information on the existing electrical infrastructure, operations, critical loads, relevant base studies/assessments, and the like. A process flow chart for IEP development is shown in Figure 2.

PROJECT STATUS/RESULTS: HNEI Grid**START** has prepared and delivered the project scope and work plan to conduct the required analysis and complete the IEP for MCBH. Data collection has been initiated with MCBH personnel.

Funding Source: Office of Naval Research, APRISES

Contact: Leon Roose, lroose@hawaii.edu, (808) 956-2331

Last Updated: October 2019

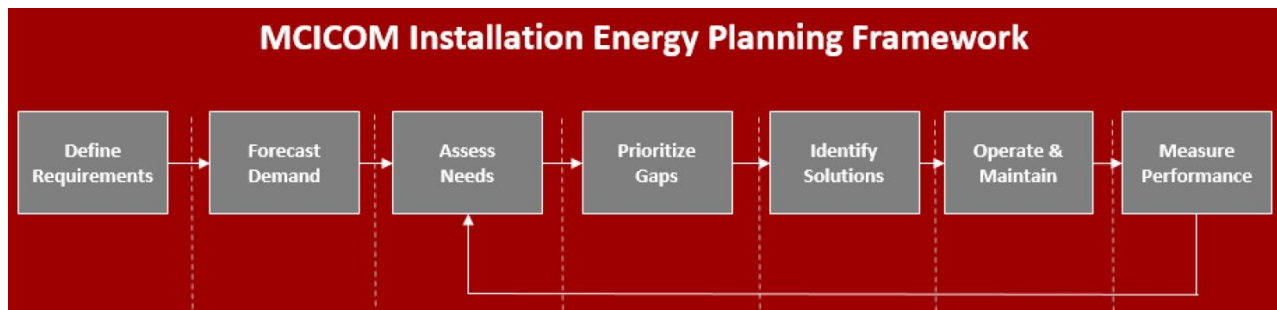

Figure 2. IEP process flow chart



OBJECTIVE AND SIGNIFICANCE: This HNEI GridSTART and Maui Electric Company joint project implemented a practical, inexpensive and effective solution featuring a Dynamic Load Bank (DLB) with customized controls that provides a reliable means to prevent the island’s baseload diesel generators from operating below their safe minimum production level while enabling the grid connection of significantly more rooftop PV on Moloka‘i. Further research and controls development is aimed to deliver additional grid value from this asset investment, such as frequency regulation functions. Lessons learned from this project may enable higher penetration levels of distributed PV systems on microgrids and islanded power systems.

BACKGROUND: Among the challenges faced by utilities to integrate very high levels of rooftop solar photovoltaic (PV) resources on islanded grids is maintaining the minimum reliable operating level of conventional diesel generators during times of high PV production. When high PV production pushes generators below their minimum operating point, the “excess energy” produced by the uncontrolled rooftop PV systems degrades grid reliability and performance to unacceptable levels.

Moloka‘i reached its system-wide rooftop PV hosting capacity in 2015, resulting in a queue of customers applications totaling about 700 kW of rooftop PV projects that could not be grid connected. HNEI GridSTART’s analysis showed the potential for excess energy production by the additional rooftop PV systems held in the queue would occur very infrequently, with only 4 MWh of excess solar energy needing to be absorbed by the DLB annually, while enabling the annual use of an additional 1,100 MWh of clean energy (and corresponding reduction in fossil fuel production by roughly the same amount). The diminimis 4 MWh of excess solar energy production is not enough to economically justify investment in an energy shifting battery energy storage system.

As a practical alternative, the much lower cost DLB was proposed by GridSTART and installed in partnership with Maui Electric Company to safely absorb the excess energy when called upon on occasion. Functioning as a “safety valve” to manage excess energy, this low-cost solution has opened the

door for the interconnection of 725 kW of new customer-sited distributed PV while maintaining adequate operational reserves to ensure grid stability. The installed DLB and it’s controller are shown in Figure 1. Further research in controls development is underway to allow this asset to serve as a grid stabilizing system to rapidly react during unplanned system disruptions, such as a sudden loss of generation or load rejection event.

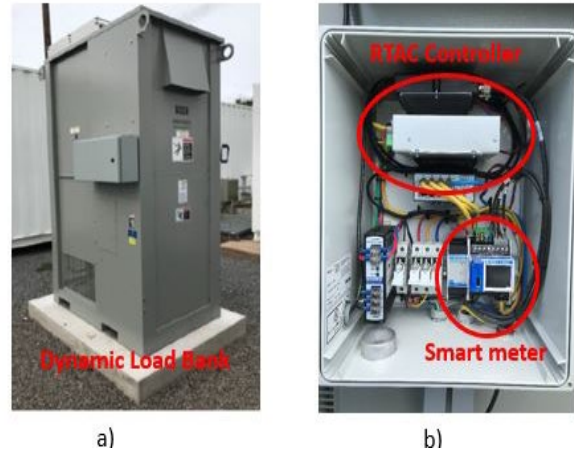

Figure 1. a) The dynamic load bank (DLB) set in utility yard and operational; b) RTAC controller with the smart meter used for tests.

PROJECT STATUS/RESULTS:

- Simulation studies are completed.
- Control algorithms were developed and validated.
- The DLB system was tested and placed into utility service on Molokai.
- 725 kW of new customer-sited distributed PV added on Molokai after no additions for more than 3 years.

GridSTART is continuing its work with Maui Electric Company to develop additional control algorithms such as automatic frequency response, increasing value for the modest technology investment.

Funding Source: Office of Naval Research, APRISES

Contact: Leon Roose, lroose@hawaii.edu, (808) 956-2331

Last Updated: November 2019



Hawaii Natural Energy Institute Research Highlights

Grid Integration

Coconut Island DC Micro-grid

OBJECTIVE AND SIGNIFICANCE: HNEI GridSTART is developing a DC based micro-grid system on Coconut Island, home to the Hawaii Institute of Marine Biology (HIMB), in Kaneohe Bay, Oahu. The project objective is to demonstrate the performance and resilience of a DC micro-grid serving two buildings on Coconut Island, including reliable power to critical building loads during interruptions of grid supply, and provide clean electrified transportation options powered primarily by solar energy. Results and lessons learned from this project can be utilized for the design and development of future DC based micro-grids at other locations in Hawaii or abroad.

BACKGROUND: Among HIMB's goals is for the island and its research facilities to serve as a model for sustainable systems. Thus, it's an ideal site for a renewable energy technology-based test bed that represents a remote location vulnerable to energy disruption, yet serving critical power needs essential to its mission. Key project goals include:

- Demonstrate innovative new clean energy technologies;
- Increase island energy sustainability;
- Reduce energy dependence upon the local utility and the existing aged undersea electrical service tie to the island, enhancing energy assurance and resilience for select critical loads;

- Provide a research platform to study DC micro-grid technologies (e.g., DC micro-grid controller, energy storage, and DC powered appliances) in a tropical coastal environment;
- Provide DC micro-grid integrated solar powered all-electric land and sea based transportation options.

PROJECT STATUS/RESULTS: GridSTART, in collaboration with the Okinawa Institute of Science and Technology (OIST) and the PUES Corporation, completed the development and deployment of a DC powered electric boat, land vehicle and portable emergency power source using a swappable battery system charged by solar energy. Elements including a 6kW rooftop PV system, DC lighting, DC air conditioning, battery storage, DC grid controller, power meters and data collection equipment, and the balance of system infrastructure are in various stages of procurement and installation. The entire DC based micro-grid test bed is shown in Figure 1 below.

Funding Source: Office of Naval Research, APRISES

Contact: Leon Roose, lroose@hawaii.edu, (808) 956-2331

Last Updated: November 2019

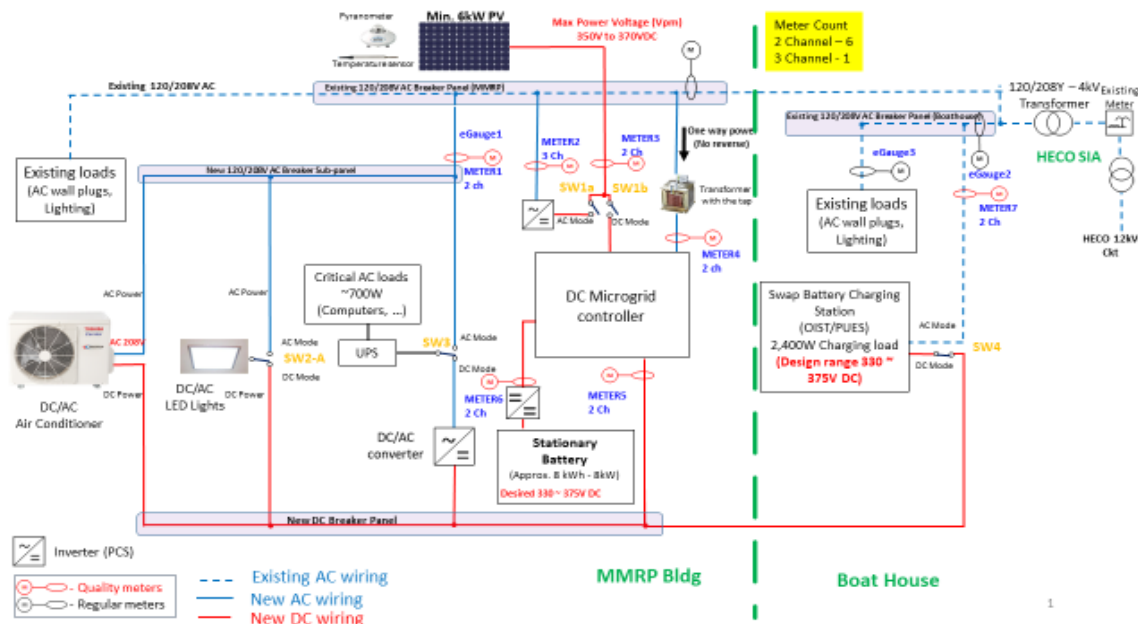

Figure 1. DC micro-grid single line diagram



Hawaii Natural Energy Institute Research Highlights

Grid Integration

Load and PV Data Synthesis

OBJECTIVE AND SIGNIFICANCE: The objective of the research activity is to synthesize a full set of disaggregated solar photovoltaic (PV) and customer load data from a limited number of field measurements to enable realistic distribution feeder modeling and state analysis for circuits with high distributed PV penetration. Actual field metered measurements of customer load and PV system production is very limited today, yet effective circuit power flow modeling requires the representation of the individual time-varying energy production and demand profiles at all electrical buses. This work is crucial in the development and testing of distributed control algorithms for distributed energy resources on an entire feeder with high penetration of distributed PV systems.

BACKGROUND: Under the earlier US Department of Energy (DOE) funded Maui Advanced Solar Initiative, HNEI deployed approximately sixty (60) distribution-level power monitoring devices to capture high resolution data at key nodal points located at distribution service transformers, PV inverters, and residential homes. In conjunction, a detailed electrical model was developed as shown in Figure 1. The rooftop PV systems and customer loads are marked with green and red circles, respectively. This feeder serves approximately 800 customers, with a total installed rooftop PV capacity of approximately 2 MW and a daytime minimum feeder load of 975 kW, a PV penetration level of more than 200%.

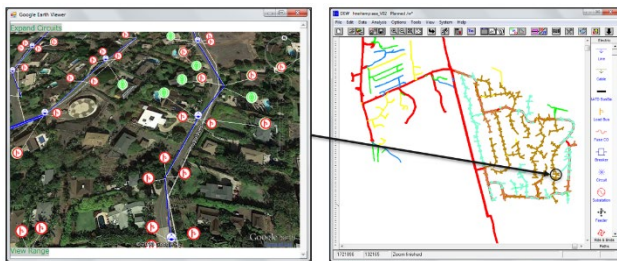

Figure 1. Maui Meadows distribution circuit

PROJECT STATUS/RESULTS:

HNEI GridSTART developed a spatial-temporal algorithm to estimate the PV generation at 280 nodal points based on limited field collected data of nearby PV systems. The PV data set (field and synthesized), total feeder net load, and measured net load at each distribution service transformer are the inputs to the stochastic data estimation method for synthesizing

gross load at distribution service transformers where field data was not available. The data flow is shown in the diagram below.

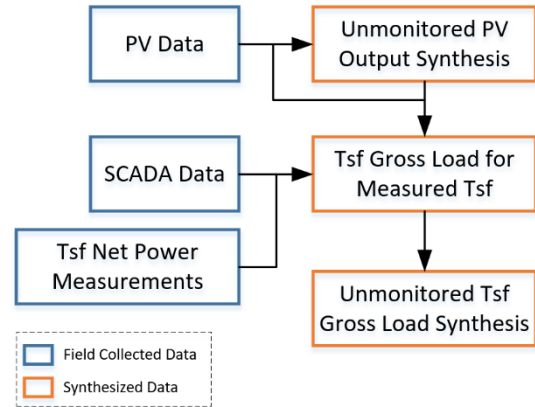

Figure 2. Data flow of PV and load data synthesis

Validation of the synthesized load and PV data was achieved by injecting it along with the limited field measurements into the electrical model and comparing the voltages from the power flow with the voltages measured in the field. The results are illustrated in Figure 3 below with mean errors for each transformer voltage ranging between 0.16% to 1.47%.

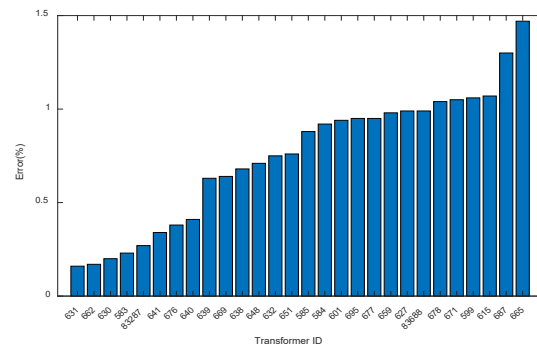

Figure 3. Voltage magnitude error between simulation and field measurement

Applying this approach to data synthesis, more effective distributed controls development and testing on a range of research activities is better enabled.

Funding Source: Office of Naval Research, APRISES

Contact: Leon Roose, lroose@hawaii.edu, (808) 956-2331

Last Updated: October 2019



Hawaii Natural Energy Institute Research Highlights

Grid Integration

Bi-directional EV Charging Demonstration Project

OBJECTIVE AND SIGNIFICANCE: The main objective of this demonstration project is to develop and evaluate the performance of novel GridSTART algorithms to optimize the charge/discharge of shared fleet vehicles. Project experience and results will inform University consideration of options such as the electrification of fleet vehicles, advanced car share applications, integration of distributed renewable energy resources on campus, and the optimal management of campus energy use and cost containment.

BACKGROUND: HNEI GridSTART is collaborating with Hitachi Limited (Hitachi) on a technology development, test and demonstration project to install two (2) bi-directional electric vehicle (EV) chargers (Hitachi’s Hybrid-PCS) at two designated parking stalls adjacent to Sinclair Annex buildings, University of Hawai’i at Mānoa. Figure 1 depicts the planned location of the two Hitachi Hybrid-PCS units on campus.

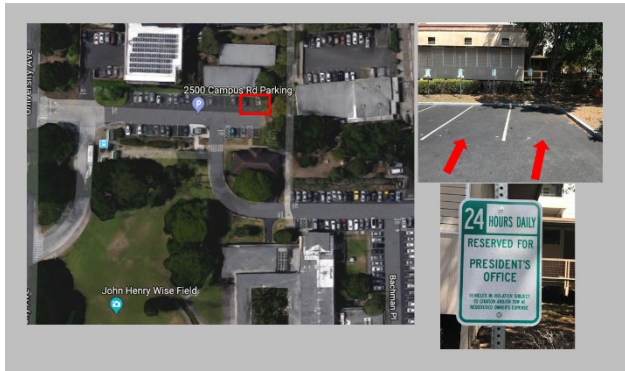

Figure 1. Location of bi-directional EV chargers

The new control algorithms will ensure that the shared vehicles for designated UH personnel use are efficiently assigned and readily available for transport needs, while providing ancillary power and energy services by virtue of the stored energy in the vehicle batteries to benefit both the customer (UH Mānoa) and possibly the operational needs of the local grid operator (Hawaiian Electric Company).

Two EVs will be used by designated university personnel through a limited-user pool car sharing system via a smart phone/web-based app made available to the drivers. More specifically, two EVs with associated EV charge/discharge stands are

planned to replace the present use of two existing UH gasoline-powered vehicles for the duration of this two-year demonstration. A functional diagram of the system is shown in Figure 2.

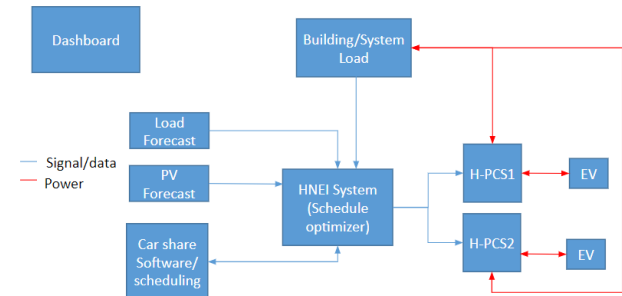

Figure 2. Functional diagram

A commercial web-based software suite will be made available to EV users to sign-out the cars for use, and HNEI GridSTART will design, code and integrate software to optimize charge/discharge schedules for the EVs, balancing transport needs and power/energy benefits for the University (building load shaping, demand charge reduction, smart EV charging, etc.), and possibly grid ancillary services. The Hitachi bi-directional EV chargers can also incorporate solar PV power as a source of energy for EV charging; GridSTART’s optimization software will thus incorporate state-of-the-art solar forecasts under development by GridSTART and maximization of solar energy as the preferred source for EV charging. Project results are of wide interest.

PROJECT STATUS/RESULTS: HNEI has taken delivery of the first Hitachi Hybrid-PCS for the project. The procurement of design/construction services and equipment needed to install the bi-directional chargers on campus, and the purchase of EVs is underway.

Funding Source: Office of Naval Research (APRISSES); Hitachi Advanced Clean Energy Corporation

Contact: Leon Roose, lroose@hawaii.edu, (808) 956-2331

Last Updated: November 2019



OBJECTIVE AND SIGNIFICANCE: Conservation voltage reduction (CVR) is one of the most cost-effective ways to save energy. The main principle of CVR is that energy and peak demand can be lowered by reducing the voltage level. A reduction in energy consumption in the range of 0.7% to 0.9% is anticipated for every 1% reduction in voltage. This is the primary value proposition of effective CVR implementation – reduced energy use by more effective management of customer service voltage.

BACKGROUND: Working in close collaboration with Marine Corps Facilities personnel in Okinawa, seven (7) distribution service transformers on a branch of the 13.8 kV distribution circuit serving the Plaza Housing complex, as shown in Figure 1, was identified for CVR field test and evaluation. The CVR controlled feeder section is isolated with a new voltage regulator (VR) to control the voltage at “downstream” service transformers, essentially behaving like a substation transformer load tap changer (LTC) for the limited section of the feeder under test. The LTC action (emulated by the VR) shifts the voltage profile of the feeder up or down, but it does not have the ability to manage individual low or high voltage points along the feeder path. The lowest the LTC can go is constrained by the minimum voltage point at any point along the feeder. HNEI has patented and field demonstrated a method of localized voltage management with an Advanced CVR device to: (1) smooth the voltage profile; (2) boost the lowest voltage at a distribution service transformer and thereby allow the LTC to further shift down the entire feeder voltage; and (3) provide local CVR benefit for downstream customers.

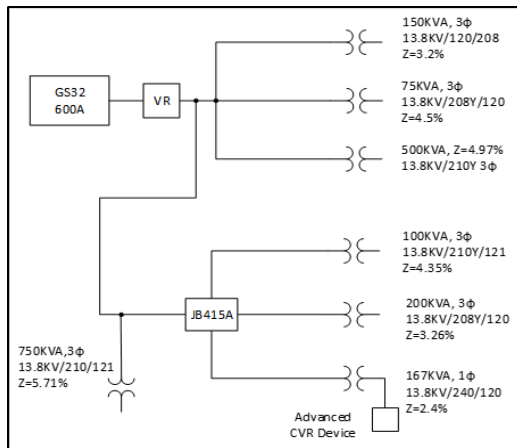

Figure 1: CVR Demonstration Single-Line Diagram

PROJECT STATUS/RESULTS: Utilizing HNEI GridSTART’s hardware-in-the-loop (HIL) laboratory platform, test and validation of the HNEI developed CVR control algorithm, including communication between the controller and field meters to be located at service transformers, all to achieve maximum CVR benefits, was completed. Figure 2 depicts the major components of the HIL test set-up.

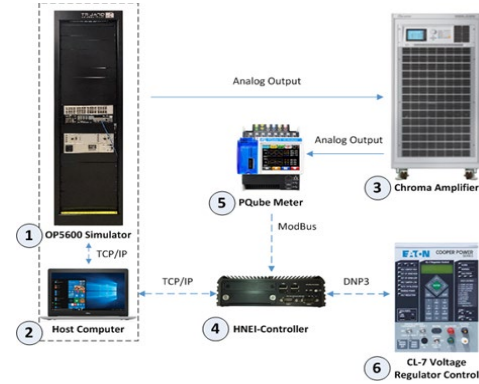

Figure 2. CVR Real-time HIL test

Multiday real-time HIL simulations using field voltage measurements collected from the project site were completed to ensure robust and reliable operations of the algorithm and HNEI-controller under a full range of load conditions. Figure 3 is an example of a 24-hour period with and without the CVR algorithm in operation.

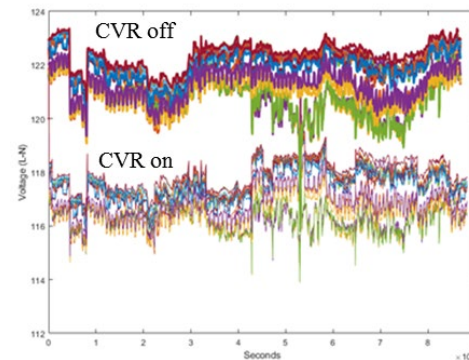

Figure 3: Voltage Profiles with CVR on and off

Field design and construction to install all components of the CVR system is underway in Okinawa. Full operation is set for Q1, 2020.

Funding Source: UH ARL; ONR-APRISSES
Contact: Leon Roose, lroose@hawaii.edu, (808) 956-2331

Last Updated: November 2019



Hawaii Natural Energy Institute Research Highlights

Grid Integration

A Sustainable Grid Platform with Enhanced System Layer and Fully Scalable Integration

OBJECTIVE AND SIGNIFICANCE: HNEI Grid**START** is a sub-awardee to the University of Central Florida (UCF) under this three (3) year project which aims to meet the long-term goal of designing highly scalable technologies for distribution systems to operate reliably and securely with extremely high penetration of distributed energy resources, with a focus on solar photovoltaic (PV) systems. The results from this project will provide a scalable solution that can be adapted to grids of various sizes, and facilitates the integration of additional distributed energy resources.

BACKGROUND: The project overview is summarized in Figure 1. The expected outcome of this project includes:

- A modular, plug-and-play, and scalable Sustainable Grid Platform (SGP) for real-time operation and control of the distribution network.
- Advanced distribution operation and control functions to manage extremely high penetration (> 100% of distribution peak load) solar generation in a cost-effective, secure, and reliable manner.
- Software and Hardware-in-the-loop (HIL) test platform.

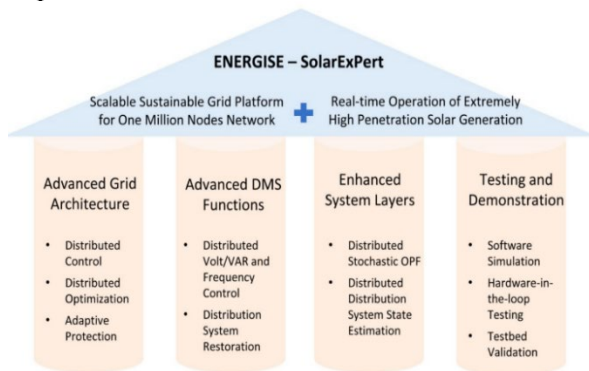

Figure 1. SolarExPert project overview

HNEI Grid**START** developed, tuned and calibrated the detailed electrical model of a high PV penetrated distribution feeder on the island of Maui based on an extensive collection of field measured data. This high-fidelity electrical model is used in the testing and tuning of the open source software of the SGP and advanced DMS functions developed by UCF.

PROJECT STATUS/RESULTS:

The detailed Maui island distribution feeder modeled with extremely high penetration distributed PV was

developed in the OpenDSS environment. The topology of the circuit and the voltage profiles from the modeled power flow calculations were compared with field collected voltage measurements to evaluate the accuracy of the model as shown in Figure 2 below.

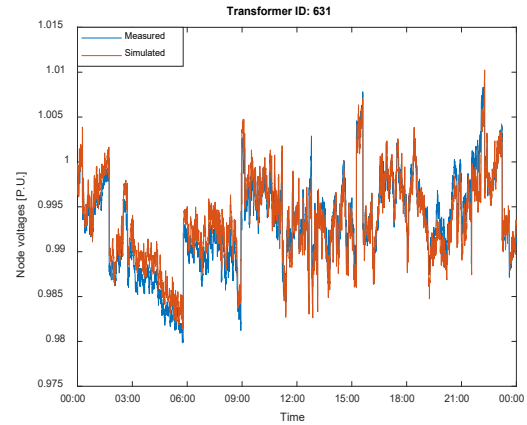

Figure 2. Node voltage validation

The calibrated electrical feeder model was then employed to verify the effectiveness of the PV hosting capacity estimation method and the distributed volt/VAR optimization control algorithm as illustrated in Figure 3.

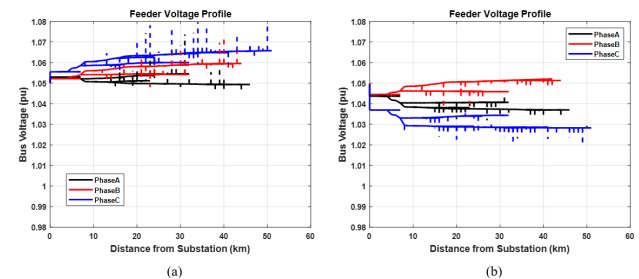

Figure 3. The voltage profile of the Maui test feeder: (a) without the voltage control algorithm; (b) with the voltage control algorithm.

With two years of the project successfully complete, the final year of the project will have HNEI Grid**START** test and assess the magnitude of additional distributed PV hosting capacity that advanced voltage management algorithms applied at scale in the distribution system may provide.

Funding Source: U.S. Department of Energy

Contact: Leon Roose, lroose@hawaii.edu, (808) 956-2331

Last Updated: November 2019



Hawaii Natural Energy Institute Research Highlights

Fuel Cell & Battery Technology

NELHA Hydrogen Station & Fuel Cell Electric Buses

OBJECTIVE AND SIGNIFICANCE: The objective of this project is to install and operate a hydrogen production and dispensing station on the Island of Hawaii at the Natural Energy Laboratory Hawaii Authority (NELHA) to evaluate the performance and durability of the equipment, and support a fleet of three hydrogen Fuel Cell Electric Buses (FCEB) operated by the County of Hawaii Mass Transit Agency (MTA). The knowledge gained in this project will inform the MTA on transitioning from a diesel bus fleet to a zero emissions FCEB fleet to meet the State of Hawaii’s clean transportation goals.

BACKGROUND: Development of hydrogen-based transportation systems requires hydrogen infrastructure to produce, compress, store, deliver, and dispense hydrogen. The NELHA hydrogen station is designed to dispense hydrogen at 350 bar (5,000 psi) to support deployment of heavy-duty FCEBs operated by the MTA Hele-On public bus service. HNEI will also demonstrate centralized hydrogen production and distributed dispensing using its fleet of 3 hydrogen transport trailers (HTT) by delivering hydrogen from NELHA to a dispenser located at the MTA base yard in Hilo. In non-technical areas, HNEI is supporting state policy makers by developing implementation plans and making recommendations for new policy to support the introduction of zero emission transportation systems.

PROJECT STATUS/RESULTS: The hydrogen station has been installed and is being commissioned. The station uses an electrolyzer powered by the HELCO grid to produce 65 kg of hydrogen per

day. The first HTT has been delivered. The first bus is a 29-passenger ADA-compliant shuttle bus manufactured by Eldorado National and converted to a hydrogen-electric drive train by US Hybrid.

The 40 kW fuel cell system is supplied by hydrogen stored in composite carbon fiber cylinders. The fuel cell power system is integrated with two 11 kWh Lithium-ion battery packs to provide motive power to a 200 kW electric drive system during acceleration. At steady state cruising speed, the fuel cell maintains the battery charge within a range that supports the long-term health of the battery. During deceleration, the electric motor acts as a generator sending power back into the battery (“regeneration braking”). This contributes to overall system energy efficiency and improves bus mileage. The bus stores 20 kg of gaseous hydrogen and has a range of approximately 200 miles depending on the route topography and driver skills. A 10kW export power system has been installed in the bus to enable the bus to provide 110/220VAC electric power for continuous power for up to 30 hours as emergency power for civil defense resilience operations when the grid power is down.

Funding Source: U.S. Department of Energy; Office of Naval Research (APRISSES); State of Hawaii Hydrogen Fund; NELHA; U.S. Hybrid; State of Hawaii Barrel Tax

Contact: Mitch Ewan, ewan@hawaii.edu, (808) 956-2337

Last Updated: November 2019



Figure 1. NELHA 65 kg/day Hydrogen Station



Figure 2. Hydrogen Transport Trailer



Figure 3. 29-Passenger MTA Bus



Hawaii Natural Energy Institute Research Highlights

Fuel Cell & Battery Technology

Battery Energy Storage Systems Durability & Reliability

OBJECTIVE AND SIGNIFICANCE: The objective of this project is to understand and forecast the degradation of batteries in large grid deployed systems. The knowledge gained in this project suggests best practices that will improve durability and safety of large batteries deployed on the electric grid. This work also showed the benefits of using titanate-based cells for storage applications, especially for reserve applications.

BACKGROUND: Battery Energy Storage Systems (BESS) show promise in mitigating many of the side effects of high penetration of non-dispatchable renewable generation. HNEI has initiated an integrated research, testing, and evaluation program to assess the benefits and durability of grid-scale BESS for various ancillary service applications. For this project, 3 demonstration MW systems are in operation in the Hawaiian archipelago. The first one was deployed in December 2012 on the Big Island and the other two were deployed in Molokai and Oahu in 2016. Their usage is closely monitored and maintenance cycles are undertaken using protocols recommended by the manufacturer as well as custom HNEI protocols, developed under this project, that provide more insights on battery degradation.

Real usage from the BESS was carefully analyzed to enable laboratory testing of their individual cells under representative conditions.

These cells are different from typical Lithium-ion cells as they employ negative electrode based on titanate rather than graphite. Close to 100 cells were

tested to monitor aging patterns, reproduce the aging observed in real life, and accelerate the degradation.

This project showed that, because of the lower voltages, these cells are far less sensitive to degradation induced by calendar aging and high state of charges than traditional batteries. Moreover, their capacity fading pace is also slower. However, based on our results and a 5 year forecast, we are projecting that accelerated degradation, a typical occurrence in traditional lithium ion batteries, remains of concern under certain conditions, Figure 1. Whether or not the deployed BESS is, or could become, at risk is currently under investigation with some modeling as well as module swapping for closer inspection.

PROJECT STATUS/RESULTS: This project led to 9 publications so far including “Battery Energy Storage System battery durability and reliability under electric utility grid operations: Analysis of 3 years of real usage”, Journal of Power Sources, Vol. 338, p. 65; “Battery durability and reliability under electric utility grid operations: Representative usage aging and calendar aging”, Journal of Energy Storage, Vol. 18, p. 185.

Funding Source: Office of Naval Research (2014-present).

Contact: Matthieu Dubarry, matthieu@hawaii.edu, (808) 956-2349; Marc Matsuura, marcmm@hawaii.edu, (808) 956-5070

Last Updated: October 2019

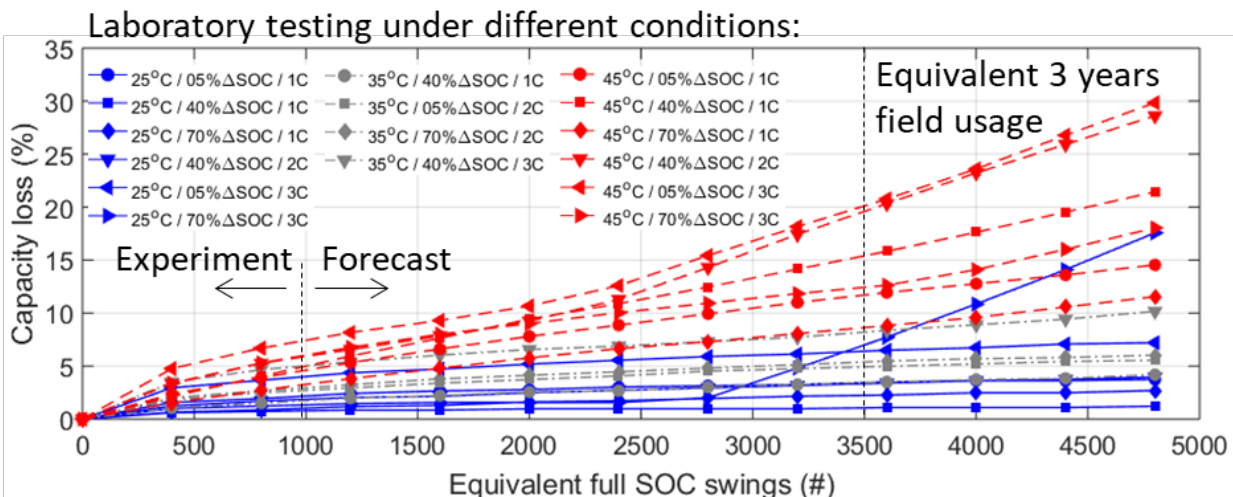



Hawaii Natural Energy Institute Research Highlights

Fuel Cell & Battery Technology

Path Dependence of Battery Degradation, EV Batteries for Grid Support

OBJECTIVE AND SIGNIFICANCE: Forecast the impact of fast charging as well as grid-vehicle interactions on the performance and durability of Li-ion batteries in electric vehicles. The knowledge gained in this project is used to suggest best practices that will help implementing successful electric vehicle fast charging, V2G and G2V programs.

BACKGROUND: Electrification of automobiles and fossil-fuel displacement by renewable energy sources are crucial to combat climate change. The successful adoption of these clean energy technologies could benefit from integration strategies such as fast charging and the sourcing/sinking energy to/from the electric grid known as vehicle-to-grid (V2G) and grid-to-vehicle (G2V), respectively.

Understanding and mitigating battery degradation is key to improving the durability of electric vehicles and the reliability of power grids. Battery degradation is path dependent; this means that not only the degradation pace is affected by usage but also the type of degradation the batteries experience. Lithium-ion batteries are known to degrade slowly at first before a rapid acceleration of which starting time will depend on the degradation mechanisms.

Our study showed that a simplistic approach to V2G, namely that an EV is discharged at constant power for 1h without consideration of battery degradation, is not economically viable because of the impact additional V2G cycling has on battery life.

It has to be noted that, because of path dependence, different usages might lead to different results and thus that our results should not be generalized. This was proved further through the fast charging side of this project where batteries were shown to have 4x shorter life even though they were used less aggressively than other similar cells.

Overall, our work showed that, with good battery prognostic models and further advances in understanding the causes, mechanisms and impacts of battery degradation, a smart control algorithm could take all these aspects in consideration and make V2G and fast charging a reality.

PROJECT STATUS/RESULTS: This project led to 8 publications so far, including “The viability of vehicle-to-grid operations from a battery technology and policy perspective”, Energy Policy, Vol. 113, p. 342; “Durability and Reliability of Electric Vehicle Batteries Under Electric Utility Grid Operations: Bidirectional Charging Impact Analysis”, Journal of Power Sources, Vol. 358, pp. 39.

Funding Source: Office of Naval Research, APRISES

Contact: Matthieu Dubarry, matthieu@hawaii.edu, (808) 956-2349

Last Updated: November 2019

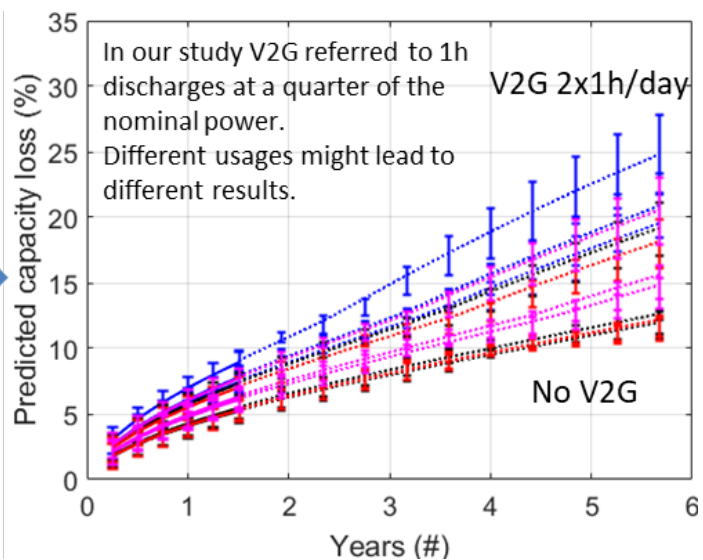
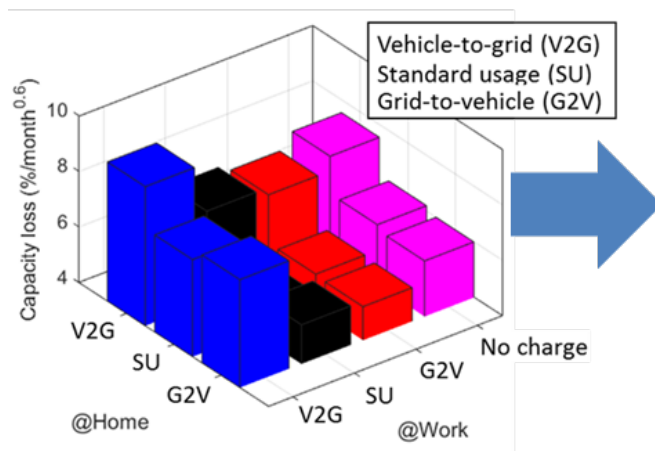



Hawaii Natural Energy Institute Research Highlights

Fuel Cell & Battery Technology

Water Purification with Ion Exchange Membrane and Porous Media

OBJECTIVE AND SIGNIFICANCE: To develop a novel, low-cost water purification technology with ion exchange membrane and porous media. The novel method utilizing low-grade heat may reduce the energy consumption to less than 1 kWh/m³ for seawater desalination. It will benefit to more than 50% of the U.S. population lives within 50 miles of the coast, and contribute towards meeting the worldwide increasing demand for fresh water.

BACKGROUND: The demand for fresh water is increasing due to the rapid population growth and economy development. Brackish water desalination and wastewater reuse are the potential solutions to addressing the water shortage and sustainability. Currently, there are around 20,000 desalination plants with a total capacity of hundred million cubic meters of water per day. These systems utilizing either membrane or thermal processes include: reverse osmosis (RO), nanofiltration, forward osmosis, electrodialysis (ED), membrane distillation (MD), multi-stage flash (MSF) distillation, multiple-effect distillation, dew-vaporation, directional solvent extraction, and thermal-ionic desalination. Among the four mature technologies, RO and ED are two membrane processes, whose advantages are offset by the large consumption of high-grade energy (electrical or mechanical energy) for maintaining high pressure and the limited current density due to ion depletion at the solution–membrane interface, respectively, as well the scaling and fouling issues. MSF distillation is a thermal process operated within 90 -110 °C with a highest energy consumption since the phase changes. MD is a relatively new technology, utilizing porous hydrophobic membranes and thermal process derived by vapor pressure differential. But the processes still involve phase changes, which reduce the energy efficiency and the wetting issue increases the fouling risk.

At HNEI, a novel water purification method is being developed based on both membrane and thermal processes. The method is applying an ion selective membrane and porous media and operated below 80 °C. Similar to MD, hot brine or waste water is fed in one side of the membrane and permeate comes out from another side as fresh water; the salts, particles

and other undesirable molecules are blocked and flow out as concentrate or waste. Compare to MD, the novel method employs a dense hydrophilic ion selective membrane other than a porous hydrophobic membrane. The separation processes is suspected subject to a specific driving force of water activity but not the vapor pressure, though both differentials are originally from thermal gradients. The benefits of the novel method include:

- No phase change lowers energy consumption;
- Operation below 80 °C facilitates low-grade heat utilization;
- Ion selective membrane increases ions rejection rate;
- Simple process reduces pretreatment requirements.

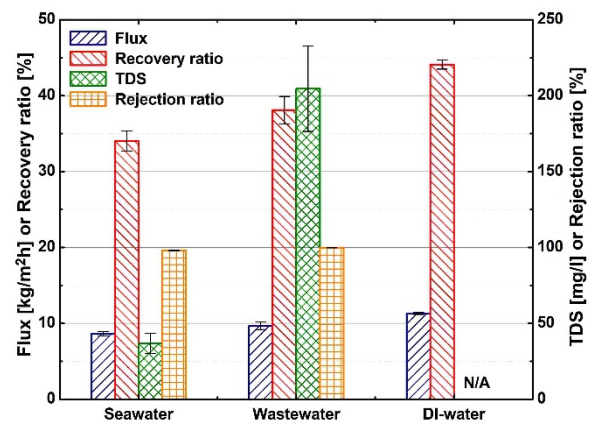

Figure 1. Purification performance of the novel method

PROJECT STATUS/RESULTS: Initial tests indicate less than freshwater standard (500 mg/l) of total dissolved solid (TDS) in permeate, significantly improved recovery (> 30% with > 99% ions rejection) and productivity (~ 8.6 or 9.7 kg/m²h for desalination and wastewater treatment) comparing to the state-of-the-art MD system. In future, low-grade heat will be applied for a lab-scale prototype; components will be optimized for better performance and efficiency.

Funding Source: Office of Naval Research, APRISES

Contact: Yunfeng Zhai, yunfeng@hawaii.edu, (808) 593-1714; Jean St-Pierre, jsp7@hawaii.edu, (808) 956-3909

Last Updated: October 2019



Hawaii Natural Energy Institute Research Highlights

Fuel Cell & Battery Technology

NRL Fuel Cell Development for Electric Powered Unmanned Aerial Vehicles

OBJECTIVE AND SIGNIFICANCE: Fuel cells offer the opportunity to significantly increase the flight duration of electric powered unmanned aerial vehicles (UAVs). With fuel cell power systems, increases of 5-10x in flight duration are possible for the same volume and weight constraints as high energy lithium batteries. Under this task, HNEI supported the Naval Research Laboratory's (NRL) efforts to develop ultra-lightweight, high efficiency fuel cell systems for UAVs.

BACKGROUND: Electric propulsion offers several advantages over small hydrocarbon powered engines, i.e. near silent operation, instant starting, increased reliability, easier power control, reduced thermal signature, reduced vibration, and no electric generators. An early partnership between HNEI and NRL was established in 2009 to aid in NRL's development of the IonTiger UAV using a fuel cell made by an outside vendor. HNEI contributed to the program with testing and evaluation of the fuel cell system and components as well as determining effects of operation at high altitudes on the durability of the fuel cell. The program resulted in an unofficial world record fuel cell powered UAV flight of 26 hours on compressed hydrogen, and 48 hours using an NRL-developed, cryogenic hydrogen storage system.



Figure 1. NRL IonTiger in flight and 550W fuel cell (insert)

Subsequently, NRL has been developing their own proprietary fuel cells and systems for UAV

applications. HNEI has supported this effort via diagnostic testing, evaluation of needs, and design recommendations.

At the core of HNEI's capabilities is a configurable stack test station that can test fuel cell stacks up to 5kW and has the flexibility to adapt to new technologies. For this work, a helium leak station was built to evaluate the integrity of new seal designs and to locate and quantify leak rates. A suite of auxiliary equipment was also developed to evaluate cell to cell uniformity leading to design recommendations for new generations of NRL stack technology. HNEI also has developed a Hardware-in-the-Loop stack test station to support balance-of-plant system development and evaluate the dynamic capabilities of NRL stack technology. HNEI engineers have developed numerous stack testing protocols for NRL including initial break-in, build verification, durability, and failure diagnostic protocols.

In addition to the testing support, HNEI has also contributed to the system hardware development. For example, HNEI designed and reduced to practice a hydrogen recovery unit for the NRL fuel cell system to increase hydrogen utilization to greater than 99% with reduced weight and volume.

PROJECT STATUS/RESULTS: This work has resulted in numerous publications as well as one patent application filed for "Hydrogen Fuel Cell Power Source with Metal Bipolar Plates". For additional information refer to the publication listing on the HNEI website or use the contact listed below.

Funding Source: Office of Naval Research, APRISES

Contact: Keith Bethune, bethune@hawaii.edu, (808) 593-1714

Last Updated: October 2019



OBJECTIVE AND SIGNIFICANCE: The objective of the project is to synthesize and characterize novel modified MgB_2 materials with improved hydrogen cycling kinetics and hydrogen storage capacities and demonstrate their capability to meet the Department of Energy (DOE) hydrogen storage targets. If successful, the solid-state modified MgB_2 materials would be safer and cheaper than the high pressure compressed H_2 (700 bar) or liquid H_2 alternative onboard vehicle hydrogen storage systems on the market.

BACKGROUND: Magnesium borohydride, $Mg(BH_4)_2$, is one of the few materials that has a demonstrated gravimetric hydrogen storage capacity greater than 11 wt% and thus a demonstrated potential to be utilized in a hydrogen storage system meeting US DOE hydrogen storage targets. However, due to extremely very slow kinetics, cycling between $Mg(BH_4)_2$ and magnesium boride, MgB_2 , has been accomplished only at high temperature ($\sim 400^\circ C$) and under high charging pressure (~ 900 bar). More recently, THF complexed to magnesium borohydride has been shown to vastly improve the kinetics of dehydrogenation, enabling the rapid release of H_2 at $< 200^\circ C$ to give $Mg(B_{10}H_{10})$ with high selectivity. However, these types of materials have much lower hydrogen cycling capacities. This project is focused on development of modified MgB_2 by either extending the dehydrogenation of magnesium borane etherates to MgB_2 or by direct syntheses of the modified MgB_2 in presence of additives.

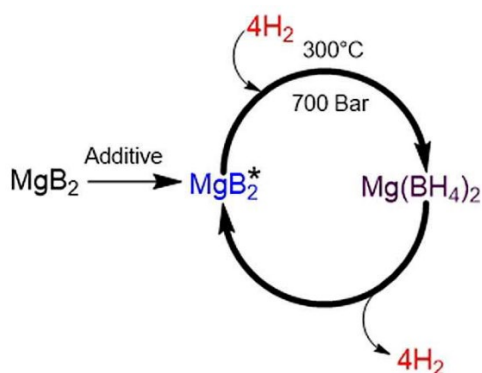

The immediate goal of the project is to show hydrogenation at temperatures and pressures below 700 bar and $300^\circ C$, Figure 1, which will be an improvement over the state of art, pure MgB_2 .

This HNEI led project is a collaborative effort between UH (HNEI and Dept. of Chemistry) and the DOE-HyMARC Consortium including; Sandia National Laboratory, Lawrence Livermore National Laboratory and National Renewable Energy Laboratory.

PROJECT STATUS/RESULTS: Our results indicate that MgB_2 , modified with a unique combination of additives can be hydrogenated to $Mg(BH_4)_2$ at the targeted conditions of ≤ 700 bar and $\leq 300^\circ C$. The hydrogenated material releases large amount of hydrogen on thermal treatment Figure 2. The reduction of the hydrogenation conditions of MgB_2 from the state of art 900 bar and $400^\circ C$ to the ≤ 700 bar and $\leq 300^\circ C$ shows the plausibility of continuously improving the hydrogenation kinetics of the MgB_2 to $Mg(BH_4)_2$.

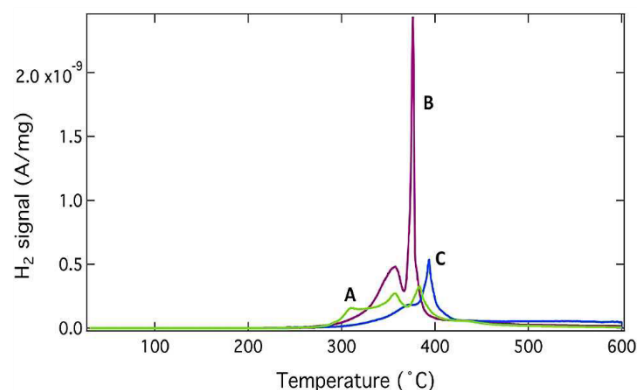

Figure 2. Typical temperature programmed desorption data of materials hydrogenated at 700 bar and $300^\circ C$ showing hydrogen release for three different modified samples (A-C).

A peer reviewed, journal cover article on discovery of additives for enhancing MgB_2 hydrogenation kinetics has resulted from this work. Efforts are underway to further improve the hydrogenation conditions of the bulk modified MgB_2 to below 200 bar and $250^\circ C$.

Funding Source: U.S. Department of Energy, EERE; Hawaii State Barrel Tax.

Contact: Godwin Severa, severa@hawaii.edu, (808) 956-3723

Last Updated: October 2019



Hawaii Natural Energy Institute Research Highlights

Fuel Cell & Battery Technology

Development of Novel Air Filtration Materials

OBJECTIVE AND SIGNIFICANCE: The objective of the project is the design, synthesis and characterization of novel, reversible high-performance acidic gas (SO_x , NO_x and H_2S) contaminant absorbent materials. The materials under development will enable fuel cell vehicles to be efficiently operated under harsh atmospheric air environments. If successful, sorbents under development will assist the fuel cell filter industry, and reduce environmental contamination from hazardous absorbent waste.

BACKGROUND: Current state-of-the-art gas purification technologies for acidic gas capture based on metal oxides and hydroxides do not meet all of the performance requirements of today's gas purification in terms of sorption: kinetics, capacities, selectivity and reversibility. This leads to large volumes of polluted absorbent waste. This situation can be expected to worsen in the future with the increased use of fuel cell vehicles that require abundant efficiently purified air as oxygen source.

The sorbent classes under development include ionic liquids, metallo ionic liquids and MOF-activated carbons. The sorbent material properties are optimized through a combination of careful selection of reactants and, modification of the sorbent cation and anion groups. For instance, metallo ionic liquids with a high content of the small, highly charged acetate and thiocyanate groups, and transition metal ions with expandable coordinative environments are being designed, synthesized and characterized.

Nano confinement of the absorbents in highly porous materials is being performed in order to increase acidic gas-sorbent interactions and hence gas sorption performance. Nano confinement is especially critical

for ionic liquids absorbents since they have high viscosity which limit gas diffusion distances into the bulk of the material. We have physically deposited thin films of 1-ethyl-3-methyl imidazolium acetate ionic liquid onto activated carbon that remain intact during exposure to SO_2 and/or NO_2 contaminated air streams.

The sorbents being developed also have relevance in other applications requiring acidic gas (SO_x , NO_x and H_2S) contaminant mitigation, including flue gas cleaning and natural gas purification.

PROJECT STATUS/RESULTS: Our work has shown that nano confined ionic liquids have high potential for SO_2 capture, with higher breakthrough capacities and times observed with the 1-ethyl-3-methylimidazolium acetate, compared to pure activated carbon and activated carbon supported potassium hydroxide sorbents, Figure 1.

Furthermore, we have recently prepared novel acetate based metallo ionic liquids and ionic salts with potential for acid gas capture at comparatively low cost compared to the pure ionic liquids. We have obtained the unique X-ray diffraction images of the novel sorbent materials' crystal structures, Figure 2. Follow on work will involve H_2S and SO_2 absorption performance testing. Two peer reviewed publications have resulted from this project.

Funding Source: Office of Naval Research, APRISES

Contact: Godwin Severa, severa@hawaii.edu, (808) 956-3723

Last Updated: October 2019

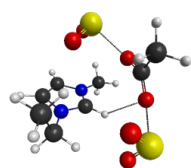
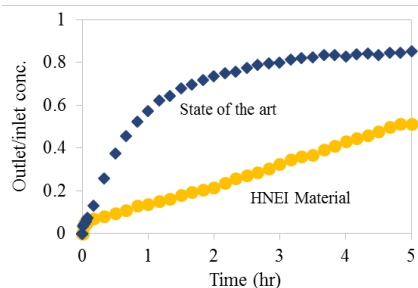

Lowest energy Structure of $[\text{C}_2\text{mim}][\text{Ac}]$ ionic liquid binding SO_2 .

Figure 1

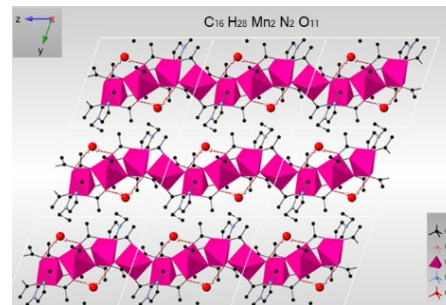

Figure 2



OBJECTIVE AND SIGNIFICANCE: Development of platinum group metal free (PGM-free) catalyst for electrochemical oxygen reduction offers a potential to reduce the production cost of proton exchange membrane fuel cells (PEMFC). Under this project we are developing highly active PGM-free catalysts and optimizing their incorporation into a fuel cell.

BACKGROUND: Today's commercial PEMFCs are typically utilizing platinum-based catalysts for anode and cathode. The substitution of Pt by PGM-free catalysts delivers not only lower manufacturing cost (less than or equal to \$3/kW), but also ensures independence from Pt and other precious metal availability and provides tolerance to airborne contaminants (NO₂, SO₂), which typically seriously affect Pt-based PEMFC performance. PGM-free catalysts consist of non-precious transition metal (Fe, Co, Mn) coordinated by nitrogen inside a carbon matrix, demonstrate activity for oxygen reduction comparable to Pt and can be inexpensively manufactured at scale (Figure 1).

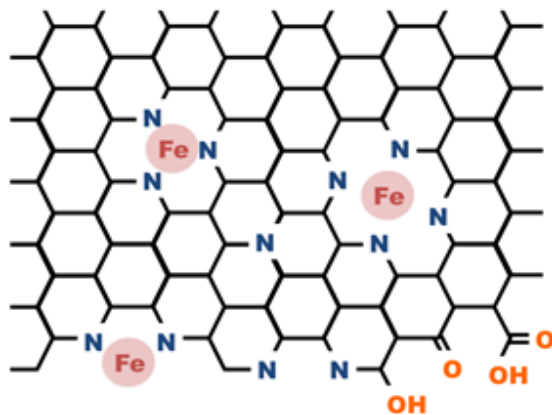

Figure 1. Schematic representation of PGM-free catalyst with Fe-N_x active sites. (A. Serov, K. Artyushkova, P. Atanassov, Adv. Energy Materials 4 (2014) 1301735).

In spite of high activity for oxygen reduction of PGM-free catalyst, the ability to achieve performance and durability similar to Pt at a fuel cell level is a challenging task. The main contribution in the performance discrepancy is inability to create an electrode structure, which can

effectively provide oxygen access to active sites, remove water from the electrode and ensure proton transfer. Another level of complexity derived from lack of well-established protocols on fuel cell operation and testing. To make the PGM-free fuel cell performance comparable to Pt, the synergistic effort of materials design, fine tuning of the catalyst layer and comprehensive electrochemical analysis is required. This project is a joint collaboration between industry (Pajarito Powder LLC, IRD Fuel Cell) and academia (HNEI). HNEI is conducting electrochemical evaluation of the PGM-free PEMFCs by means of available advanced and proven electrochemical techniques.

PROJECT STATUS/RESULTS: The project was initiated in 2019 and the current accomplishments include:

- Studied several activation protocols for initiating fuel cell operation.
- Established an activation protocol which leads to the best performance of PGM-free PEMFCs. The protocol is using by all project partners.
- Evaluated performance of 20 different catalyst formulations in PEMFCs.
- Achieved an intermediate project milestone on PGM-free PEMFC performance of 25 mA cm⁻² at 0.85 V.

Future work will include a continuation of electrochemical studies of the best performing catalysts and electrode designs using available methods and techniques.

Funding Source: U.S. Department of Energy; Office of Naval Research

Contact: Tatyana Reshетенko, tatyanar@hawaii.edu, (808) 593-1714

Last Updated: October 2019



Hawaii Natural Energy Institute Research Highlights

Fuel Cell & Battery Technology

Mass Transfer Analysis for High Power Fuel Cells

OBJECTIVE AND SIGNIFICANCE: At high power production, the performance of electrochemical conversion systems, like proton exchange membrane fuel cells (PEMFCs), direct liquid fuel cells and metal/air batteries, are constrained by mass transport processes. The purpose of the project is to develop a novel diagnostic method for the determination of mass transfer parameters which will provide guidance for improvements in electrode structure design.

BACKGROUND: PEMFCs should operate at high current to maximize power density. Under these conditions, performance is controlled by the finite transport of reactants and products. For PEMFCs, reagents transfer from a gas channel to the catalyst occurs through molecular diffusion, Knudsen diffusion in fine pores and diffusion through water and ionomer films within a gas diffusion electrode (GDE), consisting of a gas diffusion layer and a catalyst layer (Figure 1). In order to determine and separate each of these contributions we developed the novel method.

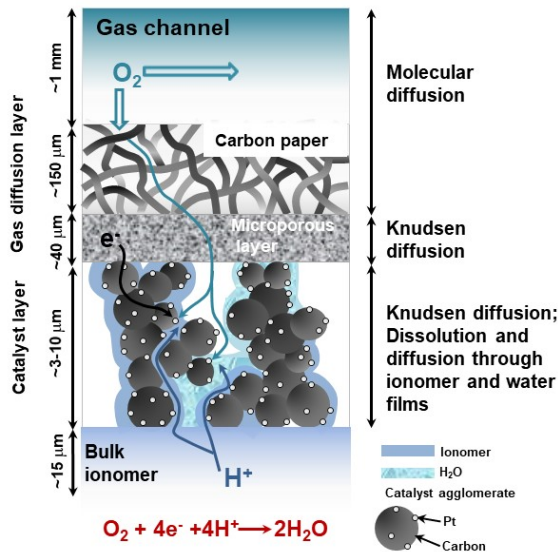

Figure 1. O₂ transport from in gas diffusion electrode.

The method is based on measurements of the limiting current distribution over an electrode area. In order to determine the current distribution, we are using a segmented cell system developed at HNEI (Figure 2). A limiting current condition can be achieved by applying highly diluted reagent mixtures (~3-7 vol.% of H₂ or O₂). Variations in diluent molecular weights

(from He to C₃H₈) and operating conditions allow us to separate the gas phase molecular diffusion coefficient, a Knudsen diffusion and diffusion through ionomer/water films.

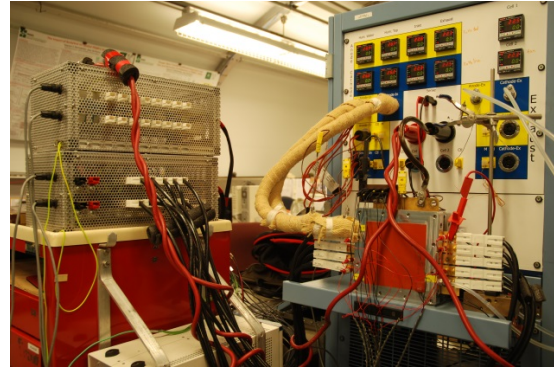

Figure 2. Segmented cell system and test station.

PROJECT STATUS/RESULTS:

- The method was validated using commercial fuel cell components from Nuvera Fuel Cell, Gore and 3M.
- The obtained results were supported and confirmed by independent measurements and modeling of electrochemical impedance spectroscopy data.
- Effects of catalyst loading and gas diffusion layer properties on oxygen mass transfer coefficient were studied. The results provided an approach on quantitative determination of different electrode components contribution to mass transfer.
- Oxygen mass transfer coefficients were determined for wide range of operating conditions (temperature, gas humidification and back pressure). These data showed an interplay between performance, operating parameters and mass transport processes in working fuel cell.

The results were reported to the funding agency, presented at scientific conferences and will be published.

Funding Source: Army Research Office; Office of Naval Research

Contact: Tatyana Reshetenko, tatyanar@hawaii.edu, (808) 593-1714

Last Updated: October 2019



Hawaii Natural Energy Institute Research Highlights

Fuel Cells & Battery Technology

Proton Exchange Membrane Fuel Cell Contamination

OBJECTIVE AND SIGNIFICANCE: Devise mitigation strategies for two widespread air contaminants: bromomethane and chloride. After cell exposure, these contaminants lead to an incomplete recovery of the energy efficiency loss. Prior art recovery methods are only partially effective because conditions are not uniform over the cell active area.

BACKGROUND: Air may contain species that are harmful to fuel cell operation at concentrations as low as parts per million (ppm) or less. Contaminants originate from natural sources and human activities. Bromomethane, a pesticide, is emitted by marine organisms. Chloride is present in seawater. These contaminants are significant to industrialized regions and coast lands including Hawaii and the Navy.

HNEI has previously developed a molecular level contamination mechanism for bromomethane using advanced characterization methods to identify contaminant transport paths and reaction intermediates and products. Bromomethane (CH_3Br) reacts with water producing methanol (CH_3OH) and bromide (Br^-) that partly covers the platinum (Pt) catalyst (Figure 1). Methanol is subsequently oxidized to harmless carbon dioxide (CO_2) on platinum and is evacuated by the air flow. The presence of bromide on the catalyst surface was found to be responsible for the irreversible cell voltage loss. Such mechanistic information facilitates the development of mitigation strategies by focusing activities on specific targets. Specifically, bromide is the mitigation target rather than bromomethane that enters the cell. Chloride (Cl^-) is expected to behave similarly to bromide and cover the catalyst surface because it is also a halogen (same periodic table group) in the same form (negatively charged ion).

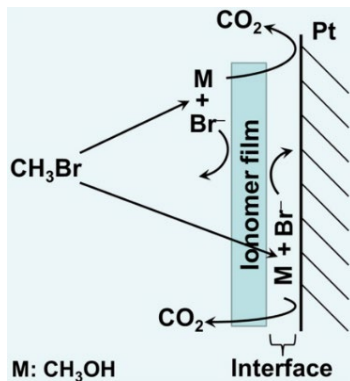

Figure 1

During the last year, HNEI designed and tested an innovative two-steps mitigation strategy. It was realized that from a mechanistic standpoint, a liquid water purge would be ineffective to dissolve bromide and chloride ions due to their location. HNEI added a step to first move these ions to another location. Furthermore, each step is performed in such a manner to ensure treatment uniformity over the electrode surface area to maximize contaminant removal.

PROJECT STATUS/RESULTS: Figure 2 demonstrates for a single cell the significant effect of 50 ppm bromomethane with an approximate 48 % voltage loss. Only 6 % of that loss is reversed after exposure.

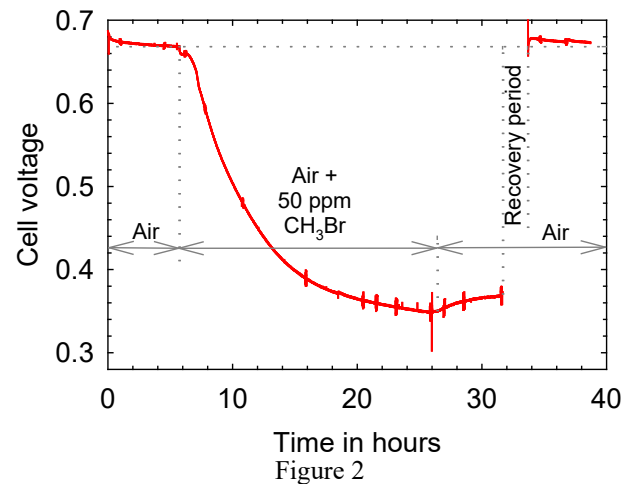

Figure 2 also shows that after a recovery period, the cell voltage has recovered within 5 millivolts of its original value. The HNEI method is equally effective with chloride and has several advantages over the prior art, including a simpler control, a more uniform removal of contaminants across the active surface, a less severe impact on degradation, and compatibility with fuel cell stacks. A provisional patent was filed. Demonstration of the concept with contaminated stacks is being pursued.

Funding Source: Office of Naval Research; U.S. Department of Energy

Contact: Jean St-Pierre, jsp7@hawaii.edu, (808) 956-3909, Yunfeng Zhai, yunfeng@hawaii.edu, (808) 593-1714

Last Updated: November 2019



OBJECTIVE AND SIGNIFICANCE: The objective of this project is to develop novel transition metal carbide catalysts for electrochemical energy storage. These new catalysts have the potential to improve the performance of electrochemical energy storage systems, such as water electrolyzers combined with fuel cells, and vanadium redox flow batteries.

BACKGROUND: The commercial application of a number of electrochemical energy storage would benefit from the availability of low cost, efficient, and durable catalysts. Pt-group metals-based catalysts are used in most commercially available fuel cells and water electrolyzers. Unfortunately, they have the shortcomings of high cost, low earth abundance, and limited lifetime. Graphite or carbon based materials have been the most common catalysts for vanadium redox flow batteries. However, they often exhibit limited electrochemical activity and kinetic reversibility. Transition metal carbides are regarded as attractive candidates because they possess an electronic structure similar to Pt which promotes high activities, good electronic conductivity, low cost, high abundance, and outstanding thermal and chemical stabilities. However, transition metal carbides fabricated by the traditional carbothermal reaction methods shows limited performance due to its small specific surface area and inevitable agglomeration at high reaction temperature.

In this work, we are proposing to develop a fabrication process for novel transition metal carbides favoring the formation of nano-sized particles that are expected to possess larger specific surface area and be more durable due to a stronger catalyst and support interaction. The composition, structure, morphology, and size will be tuned to improve activity and increase durability. Figure 1 shows X-ray diffraction patterns for two different carbon sources and for the resulting vanadium carbides. The carbon obtained from the carburization of coconut husk (C_{coconut}) is amorphous with wider peaks than graphite. The dominant phase for the vanadium carbides is V_8C_7 with an average size of 50 nm. The anodic and cathodic currents increase remarkably on vanadium carbides relative to that on graphite, indicating that vanadium carbides exhibit significantly better catalytic activities toward the negative electrode reactions (Figure 2). The use of vanadium carbide catalysts for flow batteries has not

yet been reported in the literature. Synthesis methods to target the final desired catalyst structures are being explored.

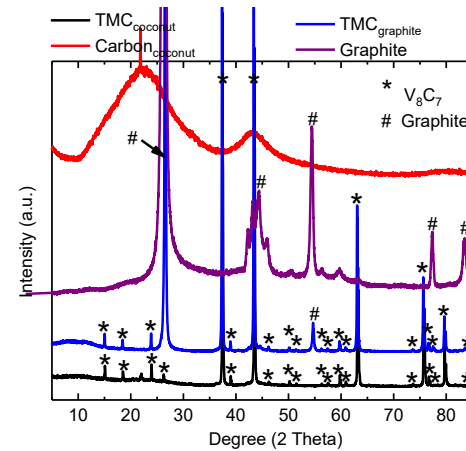

Figure 1. X-ray diffraction patterns of vanadium carbides. TMC: transition metal carbide.

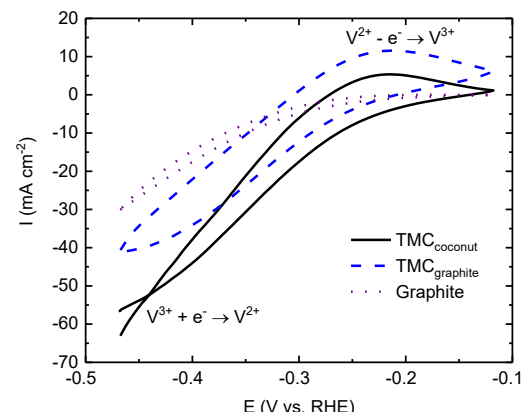

Figure 2. Cyclic voltammograms on vanadium carbides at 20 mV s^{-1} in N_2 saturated $3 \text{ M H}_2\text{SO}_4 + 1 \text{ M (V}^{2+} + \text{V}^{3+})$ at 25°C . TMC: transition metal carbide.

PROJECT STATUS/RESULTS:

1. Vanadium carbides were synthesized using two different carbons: graphite and a carbon derived from coconut husk (a Hawaii agricultural waste).
2. Vanadium carbides exhibited significantly better catalytic activities toward the negative electrode reactions than graphite which is the incumbent catalyst for vanadium redox flow batteries.

Funding Source: Office of Naval Research, APRISES

Contact: Jing Qi, qijing@hawaii.edu, (808) 593-1714; Jean St-Pierre, jsp7@hawaii.edu, (808) 956-3909

Last Updated: October 2019



Hawaii Natural Energy Institute Research Highlights

Renewable Power Generation

Printable Photovoltaics

OBJECTIVE AND SIGNIFICANCE: This research program aims at developing high-throughput ink-based fabrication techniques for light-weight thin film photovoltaics (PV). This approach has the potential to significantly reduce manufacturing costs and enable PV integration on non-conventional substrates (e.g., polyamides or woven fabrics).

BACKGROUND: Crystalline silicon has been leading the PV market for over 20 years. These panels, found primarily on roof-tops and centralized production plants, are easily recognizable by their architecture, with interconnected wafer-like solar cells laminated under a flat sheet of glass. Although well-suited for stationary electrical production, the mechanical rigidity and weight of silicon PV modules become a burden for mobile applications, where portability is far more critical than raw performance. To this regard, R&D efforts have been recently focused on methods to integrate ultra-light and flexible thin film solar materials onto lightweight/flexible substrates, including plastics (polyamides) and fabrics. Such devices can generate enough electricity to power small electronic devices (phones and electronic tablets for civilians) and sensors (healthcare diagnosis instruments for military personnel), providing a reliable source of energy when needed.

PROJECT STATUS/RESULTS: With support from the Office of Naval Research, the research team at the

HNEI/Thin Films Laboratory is developing a unique method to print thin film-based PV. Rather than relying on conventional vacuum-based deposition tools, which are costly to operate and maintain, this technique uses liquid molecular inks that already contain all the raw chemical elements necessary for the synthesis of the solar absorber. These inks can be easily printed and cured to form thin film solar absorbers. Our project is currently focused on an Earth-abundant multi-compound alloy ($\text{Cu}_2\text{ZnSnSe}_4$, CZTSe) that can meet the mechanical and weight requirements for light weight flexible PV. Our research demonstrates that high-quality CZTSe solar absorbers can be achieved with this printing technology, leading to solar cells with power conversion efficiency over 7%. However, CZTSe has the potential to achieve the 20% efficiencies already demonstrated by analogous multi-elemental thin film materials such as CuInGaSe_2 alloys. Innovative techniques are being developed by our group to passivate defects in CZTSe solar absorbers and improve their conversion efficiency (primarily increase cells output voltage).

Funding Source: Office of Naval Research, APRISES

Contact: Nicolas Gaillard, ngaillard@hawaii.edu, (808) 956-2342

Last Updated: October 2019

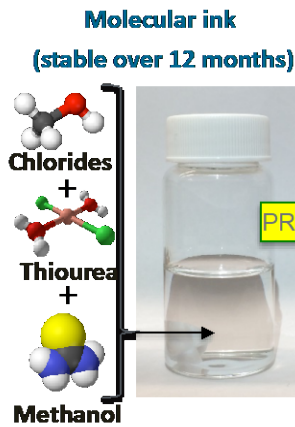

Cross-section of a printed CZTSe solar absorber

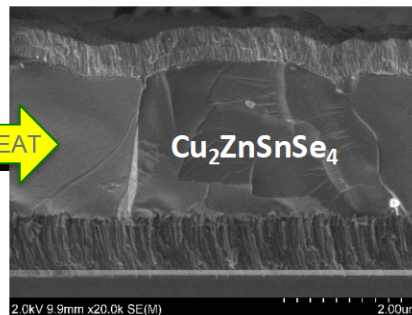

Current vs. voltage of a printed CZTSe solar cell

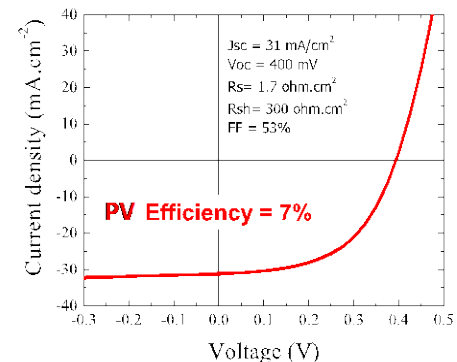



Hawaii Natural Energy Institute Research Highlights

Renewable Power Generation

Research Support to the U.S. Navy Wave Energy Test Site

OBJECTIVE AND SIGNIFICANCE: Wave energy has enormous potential to address global renewable energy goals, yet it poses daunting challenges related to commercializing technologies that must produce cost-competitive electricity while surviving the energetic and corrosive marine environment. The nascent commercial wave energy sector is thus critically dependent on available test infrastructure to address these issues. To address this need, the U.S. Navy established the Wave Energy Test Site (WETS) in the waters off Marine Corps Base Hawaii (shown below), the United States’ first grid-connected site, completing the buildout in mid-2015. WETS consists of test berths at 30m, 60m, and 80m water depths, and can host point absorber and oscillating water column devices to a peak power of 1 MW. HNEI provides key research support to this national effort in the form of environmental monitoring, independent wave energy conversion (WEC) device performance analysis, and critical marine logistical support. The results achieved at WETS will have far reaching impacts in terms of advancing wave energy globally.



BACKGROUND: Through a cooperative effort between the Navy and the US Department of Energy, WETS hosts companies seeking to test their pre-commercial WEC devices in an operational setting. HNEI works with the Navy and DOE to directly support WEC testing at WETS in three key ways: 1) *environmental impact monitoring* – acoustic signature measurement and protected species monitoring, 2) *independent WEC device performance analysis* – including wave forecasting and monitoring, power matrix development (power output versus wave height and period), numerical hydrodynamic modeling, and a regimen of regular WEC and mooring inspections, and 3) *logistics support* – in the form of funding to modify a site-dedicated support vessel for use at WETS, through local partner Sea Engineering, Inc., and through funding to WEC developers for maintenance actions.

PROJECT STATUS/RESULTS: Since mid-2015, the following major activities are noted:

- Northwest Energy Innovations (NWEI) deployed 18kW Azura device at 30m berth Jun 2015 to Dec 2016.
- Sound and Sea Technology deployed Fred. Olsen Lifesaver at 60m – Mar 2016 to Apr 2017.
- Led second deployment of Azura, with modifications designed to improve power performance – Feb to Aug 2018.
- Led effort to redeploy Lifesaver, at 30m, with modifications to moorings and integration of UW sensor package and subsea charging capability, which drew power from the WEC – Oct 2018 to Mar 2019 (shown below).
- Led major redesign and reinstallation effort for the WETS deep berth moorings. 60m berth reinstalled in May/June 2019, 80m berth in 2020.
- Next major activity – Deployment of Ocean Energy OE35 – a very large oscillating water column device (shown below) – early 2020.

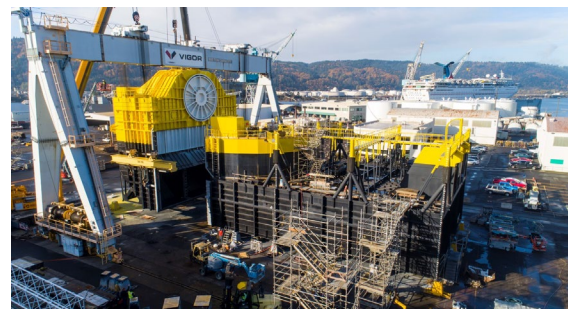

Funding Sources: Naval Facilities Engineering Command; U.S. Department of Energy; Office of Naval Research

Contact: Patrick Cross, pscross@hawaii.edu, (808) 956-5196

Last Updated: October 2019



Hawaii Natural Energy Institute Research Highlights

Energy Efficiency & Transportation

Adaptive Lighting and Energy Efficient Security Strategy

OBJECTIVE AND SIGNIFICANCE: The objective of this project is to develop and test a novel LIDAR sensor based, adaptive lighting system that has the potential to significantly enhance security and dramatically reduce energy use and maintenance costs in high-security Naval installations.

BACKGROUND: The adaptive lighting project is a collaboration between HNEI, the California Lighting and Technology Center (CLTC) at University of California, Davis, and the Navy Facilities Engineering Command (NAVFAC) Hawaii. In order to provide proof-of-concept and gain wider acceptance this demonstration project will study the design, deployment and impact of a unique wireless networked adaptive lighting solution for exterior lighting. Traditional security lighting, with long hours of uniformity, may waste energy unnecessarily and reduce the security effectiveness in some applications. Sensor-based dynamic lighting adds conspicuous visual cues to enhance security effectiveness. Adaptive lighting can save from 50-70% of exterior lighting energy and has the potential to become an effective security measure as well.

What is Adaptive Lighting? Adaptive Lighting is the term describing a wide range of lighting solutions that adjust to changing environmental conditions, indoor or out. Adaptive lighting intensity can rise and fall with ambient light and occupancy while color rendering index and temperature can be adjusted to conditions defined by the end-use criteria.

In this research project, an adaptive lighting strategy is being piloted with exterior lighting fixtures on four buildings on Oahu-- two NAVFAC buildings and two stand-alone classrooms at the University of Hawaii at Manoa. The exterior lighting levels will be variable, operating at full intensity when there is activity detected near the structures at night. With no motion detected, the fixtures will dim down to 30% providing enough of light for security purposes. Light Detection and Ranging (LIDAR) sensors send out laser signals that when reflected

back trigger an action, specifically a signal to ramp the fixtures up to 100%. Sensors are positioned on these buildings to create a 360 degree horizontal detection zone, sensitive to any motion that crosses the beam's path.

The second significant goal of this project is to test a wireless networking system that will synchronize the ramping up of all the fixtures simultaneously. When one sensor is triggered all of the fixtures connected to the network will activate together, even though they are wired independently. Not only does this prevent a visually annoying checkerboard effect with some on and some off, but it is key to the security aspect of the system. Site security is improved by the visual "announcement" that is made when motion is detected and the lights ramp immediately up from dim to 100%.

The sensors and monitoring equipment have been installed and project is currently collecting data.

The project runs from January 2019 to June 2020.



Figure 1. UH Manoa FROGs with visible side sensor

Funding Source: Office of Naval Research, APRISES

Contact: Jim Maskrey, maskrey2@hawaii.edu, (808) 956-3645

Last Updated: November 2019



Hawaii Natural Energy Institute Research Highlights

Energy Efficiency & Transportation

Building Energy Reduction in Future Transit Oriented Development Areas

OBJECTIVE AND SIGNIFICANCE: The goal of the research project is to develop and demonstrate a building energy analysis process that can be used during early design phases at multiple transit-oriented development (TOD) sites associated with Oahu’s light rail line. This benefits the State of Hawaii by helping to meet Hawaii Clean Energy Initiative (HCEI) goals; through reduced energy cost and fossil fuel use in buildings; increased energy security and resiliency; and a better quality of life for residents.

BACKGROUND: HNEI has worked closely over the years with the University of Hawaii School of Architecture’s Environmental Research and Design Lab (ERDL) to conduct energy efficiency research. Under this project ERDL is collaborating with the University of Hawaii’s Community Design Center (UHCDC) who are developing multi-family residential building conceptual designs for the State Office of Planning in a project called the “Waipahu Transit Oriented Development Collaboration: Proof of Concept Research, Planning, and Design Study.”

The center’s current TOD planning process does not include quantitative targets for building energy use for on-site renewable energy generation. Design teams lack specific guidance to design beyond the building energy code.. ERDL is collaborating with the UHCDC to focus on bridging these gaps by providing energy efficient design processes and natural daylighting strategies to help achieve HCEI goals.

PROJECT STATUS/PROGRESS: Currently underway, this project will develop and demonstrate a process to create energy use targets and identify relevant energy efficiency measures during the early-stages of building design through the use of whole building energy modeling. The desired analysis outcomes include: estimate a target energy use intensity; annual savings in energy, energy cost, and greenhouse gas emissions; reduce peak electric demand; reduce daily electric load profiles; and estimate potential for net-zero energy. The thermal comfort analysis will evaluate occupant thermal comfort with natural ventilation,

presently and in the future. As of November, the building modeling and analysis is currently being performed as well as initial daylight studies. The desired impact is for design professionals to replicate this process when designing the future buildings planned in TOD areas.

This project is scheduled for completion mid 2020. Anticipated results include:

- Developing building simulation models to evaluate multiple building scenarios:
 - Compliance with IECC 2015 and beyond
 - Parametric analysis using PUC Potential Study inputs
 - Evaluation of energy efficiency measures feasible and/or likely to be adopted by the State.
- Recommended design processes and parameters
- Design recommendations relating to thermal comfort.
- Presentation of daylight harvesting strategies



Figure 1. Photo courtesy UH CDC

Additional project summary sources: School of Architecture Environmental Research and Design Lab

Funding Source: Office of Naval Research

Contact: Jim Maskrey, maskrey2@hawaii.edu, (808) 956-3645.

Last updated: November 2019



Hawaii Natural Energy Institute Research Highlights

Energy Efficiency & Transportation

Ka Honua Momona: Maximizing Efficiency of Off-grid Nano-grid

OBJECTIVE AND SIGNIFICANCE: The project objective was to convert an existing off-grid solar PV system comprising 5.1 kW PV panels, battery storage and a backup fossil fueled generator, into a more efficient “smart” nano-grid utilizing site-scale automated load and demand management strategies to minimize wasted generation while eliminating the need for fossil fuel backup.

BACKGROUND: From 2013-2108, Ka Honua Momona, a not-for-profit community organization in Kaunakakai, Molokai operated from an off-grid system consisting of 18 PV panels, dual 7200-watt Outback inverters, and 40 kwh of lead acid storage and a fossil-fuel back-up generator. KHM found their renewable energy to be utilized inefficiently due to varied daily site utilization patterns that range from a very low baseline load (e.g., internet router and refrigerator) to a high load (e.g., large events utilize air condition, lighting and kitchen loads) that exceeds generation and storage capacity.

To help mitigate inefficiencies in generation and storage and stabilize the nano-grid, HNEI identified three goals:

- To test, compare, and utilize three 9 kWh Sunverge integrated energy storage systems in an off-grid environment
- To pilot a “smart” generation schema that will automatically redirect excess solar energy generation (load dump) to other loads that would be useful to KHM (water heating and water distillation)
- To identify practical design issues when using multiple battery banks and multiple inverters

PROJECT STATUS/RESULTS: HNEI implemented a “smart” strategy installing water heaters as a dump load for excess generation. Two water heaters use small, Heliatos™ solar thermal water heaters to provide nominally sufficient hot water for the baths. The solar thermal hot water is then augmented by Sunverge integrated energy storage units after their batteries are fully charged and are in “float” condition. This load diversion is precisely controlled by solid state auto transfer switches that transfer power to the water heaters when the battery

voltages are one volt below “float” voltage and will cutout load diversion when the batteries are two volts above low battery cutout, or (LBCO).

On the power supply side, PV panels charge the primary battery banks. Once the primary batteries reach full capacity, a solid state “smart” automatic transfer switch shifts the solar generation to a back-up set of batteries at predetermined battery voltages/condition. As these secondary batteries reach full capacity and the charging system goes into float, the load will be dumped to the third 50 gallon water heater, or a small water distiller, thereby utilizing renewable energy that would have been wasted otherwise.

This off-grid system was designed to adapt to highly variable load conditions by using excess float energy to heat water or produce water, thus minimizing wasted power generation. The project is ongoing through June 2020.



Funding Source: Office of Naval Research

Contact: Jim Maskrey, maskrey2@hawaii.edu, (808) 956-3645

Last Updated: November 2019



Hawaii Natural Energy Institute Research Highlights

Energy Efficiency & Transportation

Project FROG Net Zero, Mixed Mode Buildings

OBJECTIVE: The overarching objective of this multi-year project is to understand energy performance and operation of net zero energy, mixed mode buildings in tropical climate and to serve as research facilities for study of energy efficient building features and control schemes. The specific objectives of the current work is to measure and evaluate indoor air quality, particularly CO₂, in the manually operated mixed mode buildings. High levels of CO₂ can cause drowsiness, absenteeism and poorer student performance.

BACKGROUND: Two unique energy efficient, mixed mode, net zero energy buildings constructed on the UH Manoa campus serve as platforms for energy, comfort, and controls strategy research. Since 2016 HNEI has been extensively monitoring these Project FROG structures to gain insight into their performance both in terms of energy efficiency and thermal comfort.

The net zero energy, mixed mode buildings are designed to be naturally ventilated by openable windows that allows air to flow through the room providing fresh air. Along with energy efficiency features, the buildings are outfitted with photovoltaic systems that generate more power than they consume.

On-Demand HVAC control prevents the room from being air conditioned continuously when classroom capacity factor is only 60% during the day and zero at night. With the adjustable ceiling fans, the mixed mode buildings are comfortable for most of the year without the A/C running.

The current research focuses on observing and characterizing CO₂ levels in the mixed mode buildings and understanding the influence of window operation. As part of this project, HNEI developed a sensor providing real-time feedback on CO₂ levels, including a cue to take action to increase fresh air.

From an energy perspective, these buildings serve as models for energy efficient construction with highly insulated roof and walls, high performance low E glazing, ceiling fans, LED lighting with daylight controls, and orientation to prevent solar heat gain through the windows.

In addition as research platforms they serve as beta test sites for six different innovative controls and sensor research experiments.

- Real time CO₂ indicators
- Automated ceiling fan controls
- Innovative occupancy sensing device
- Unique hi-res energy monitoring system
- Unique power quality monitoring system
- Deployed a thermal comfort perception kiosk

PROJECT STATUS/RESULTS: The Project FROG buildings continue to serve as functioning classrooms for both high school and university classes. In this ongoing project we observed that CO₂ levels can exceed recommended levels, occasionally by a factor of two. User awareness and training are imperative to properly operate mixed mode; building decisions are made every day by the instructors that will impact the indoor air quality of a mixed mode building. Operation of windows, ceiling fans and air conditioning are judiciously used to create healthy or unhealthy indoor air quality.

The project is ongoing and will continue at least through June of 2020.



Figure 1. UH Manoa Project FROG buildings

- Positively Net Zero: Case Study
https://aceee.org/files/proceedings/2016/data/papers/10_1001.pdf
- Second Generation Zero Net Energy: Inheriting The Good Genes
<https://aceee.org/files/proceedings/2018/index.html#/paper/vent-data/p309>

Funding Source: Office of Naval Research

Contact: Jim Maskrey, maskrey2@hawaii.edu, (808) 956-3645.

Last updated: November 2019



Hawaii Natural Energy Institute Research Highlights

Energy Efficiency & Transportation

Electrified Transportation

OBJECTIVE AND SIGNIFICANCE:

This project developed a quantitative dataset to estimate and analyze ground transportation fuel use and CO₂ emissions for passenger and freight vehicles on Oahu.

BACKGROUND:

The convergence of electrified transportation and renewable power in Hawaii offers significant benefits as well as challenges to reduce imported fossil fuels and avoid their emissions from combustion. As petroleum-fueled vehicles are replaced with electric vehicles (EVs) in Hawaii, are they any cleaner and do they use less fossil fuels? Since much of the electricity in Hawaii is still generated from oil and coal, especially on Oahu, there is public concern and uncertainties surrounding the actual fossil fuel use and resulting emissions from powering EVs.

Gasoline-powered passenger vehicles comprise the largest share of all vehicles on Oahu and together emit the most CO₂ emissions, followed by gasoline-powered freight vehicles (see figure below).

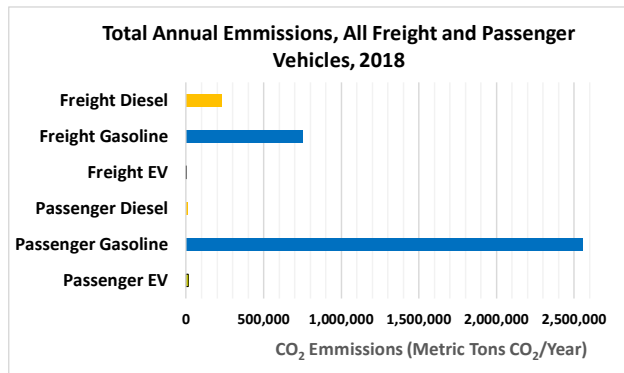

For this project the CO₂ emissions were based on combustion of the fuel on board the vehicle or at the power plant. The total fleet (passenger and freight), and per mile comparison includes:

- Fuels – Gasoline, diesel, biodiesel, and electricity (in 2017 and 2018).
- Vehicle Technologies – Internal Combustion Engine (ICE, both conventional and hybrid), and plug-in EVs.
- Vehicle Classes – Passenger, (average and efficient), and freight (both medium and heavy-duty).

PROJECT STATUS/RESULTS:

Comparing passenger vehicles, an average gasoline vehicle (22 MPG) produced *more* CO₂ emissions than the average EV (32kWh/100miles) powered from the electric grid on the island of Oahu during 2017.

But driving an efficient EV (25kWh/100mi) on Oahu in 2017 produced slightly *more* CO₂ emissions than a comparable efficient gasoline-powered hybrid vehicle (50 MPG).

In 2018 the Oahu power grid reached a turning point, with enough renewable generation so that an efficient EV produced *less* CO₂ emissions than an efficient gasoline-powered hybrid.

In 2018 an efficient EV on Oahu was comparable in CO₂ emissions to a 50.4 MPG gasoline hybrid, whereas in 2017 the efficient EV was comparable to a 49.2 MPG gasoline hybrid.

Since the power source for EVs in Hawaii is becoming cleaner, older EVs are becoming cleaner as well, (unlike gasoline vehicles). As Hawaii’s utilities continue to add more wind and solar generation to achieve the Renewable Portfolio Standards in the future, EVs powered on the islands will generate less and less CO₂ emissions, and consume less fossil fuels (unlike gasoline vehicles.)

Results of this study are currently being prepared for publication. Additionally, an interactive strawman model was created to assess fossil fuel use and emissions on Oahu as increasing renewables are added to the power grid, and as EV adoption continues (replacing gasoline vehicles). This tool provides a quantitative modeling capability to estimate the impacts of vehicle and fuel options based on current technologies and fuel sources.

Funding Source: Office of Naval Research, APRISES

Contact: Katherine McKenzie, kamcken@hawaii.edu, (808) 956-0876

Last Updated: October 2019



Hawaii Natural Energy Institute Research Highlights

Hawaii Energy Analysis & Policy

Technical and Decision Support Services to the Hawaii PUC

OBJECTIVE AND SIGNIFICANCE: This project provides the Hawaii Public Utilities Commission (PUC) with highly technical, unbiased and independent third-party review of electric utility proposals. This allows PUC staff to augment their internal analyses and consultant work with additional analysis and perspective on short notice.

BACKGROUND: Under a 2017 Memorandum of Understanding, HNEI has been supporting the PUC review of regulatory filings by conducting independent review and technical analyses to inform decision making. HNEI staff and its network of technical experts provide the PUC with the subject matter expertise and analytical capabilities required to support decision making on crucial regulatory decisions affecting Hawaii’s energy transformation. In partnership with GE Energy Consulting and Telos Energy, HNEI has developed power systems modeling capabilities to analyze the integration of renewable energy sources into Hawaii’s electric grids. Recent support activities included the following:

- **Docket Review:** Review, summary, and recommendations of demand response and grid services proposals (Docket No: 2015-0412), battery energy storage proposals (Docket No: 2018-0102 & 0103), open renewable energy RFPs and PPAs (2017-0352, 2018-0431 through 0435), Integrated Grid Planning (2018-0165), DER Policy (2014-0192), the Schofield Generating Station (2017-0213), and other ongoing reviews.
- **CRR BESS Docket Review:** Provided a qualitative and quantitative analysis to review the proposed 100 MW contingency and regulation reserve (CRR) battery.

- **Stage 2 RFP Docket Review:** Reviewed the proposed Stage 2 RFP and are actively conducting solar+storage analysis to simulate the Hawaii grids with new project proposals. This will allow policy makers and regulators to understand the expected changes to grid operations, renewable integration, and costs.
- **Ongoing Monitoring:** Ongoing reviews of actual utility operations on Oahu (using hourly generation by generation unit submitted via Docket No. 2017-0213). When compared against simulation results it allows for a review of HECO commitment and dispatch decisions and potential curtailment or uneconomic asset utilization.

PROJECT STATUS/RESULTS: Based on review and discussions with PUC staff, HNEI and Telos Energy recommended that the proposed 100 MW CRR battery was not adequately evaluated and its services could have been provided (potentially more economically) by forthcoming solar+storage hybrid plants. We also advocated for Stage 1 and Stage 2 RFP solar+storage projects to be counted as assets that could provide ancillary services and firm capacity. Both of these recommendations have been addressed in recent PUC orders over the past six months.

HNEI and Telos Energy will continue to monitor the Stage 2 RFP process and simulate what grid operations will look like at the proposed levels of renewable adoption. This will allow for a quick review of specific projects or PPA structures if requested by the PUC.

Funding Source: PUC; Hawaii State Barrel Tax

Contact: John Cole, colejohn@hawaii.edu, (808) 956-9390, Richard Rocheleau, rochelea@hawaii.edu, (808) 956-8346

Last Updated: November 2019

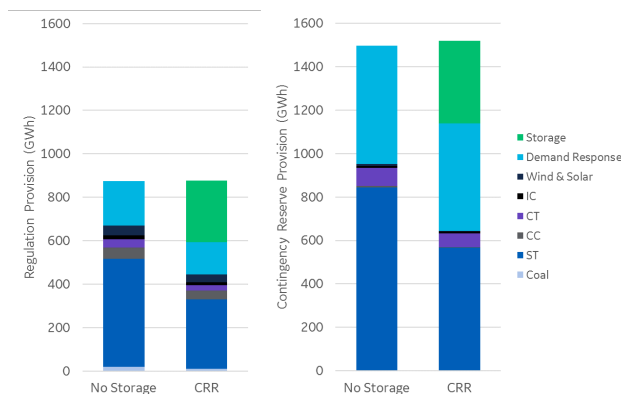



Hawaii Natural Energy Institute Research Highlights

Hawaii Energy Analysis & Policy Integrated Grid Planning Support

OBJECTIVE AND SIGNIFICANCE: This project supports the Hawaiian Electric Companies Integrated Grid Planning (IGP) Process by providing technical expertise and independent analyses to help inform the utilities, regulators and other stakeholders decision making in the electric system planning process.

BACKGROUND: In a novel way, the HECO Companies new IGP process brings together generation, transmission and distribution, and procurement planning into a single integrated process. See Figure 1. The HNEI Director is the Chair of the IGP’s Technical Advisory Panel (TAP) that is comprised of national and international electricity systems experts. The TAP provides independent assessment, review, feedback, and critique of the utility’s planning models, methods, assumptions, and results.

HNEI has supported TAP activities and has provided detailed technical reviews of the HECO IGP interim methodologies, modeling results, future plans and draft reports. This includes suggestions related to alternative methodologies, data sources, and modeling tools that the utility may consider implementing during the IGP process, as well as supplementary technical analysis to augment utility efforts.

PROJECT STATUS/RESULTS: Specific IGP recommendations include the following:

- **IGP Reserve Planning Criteria:** HECO’s proposed IGP reserve requirements should align directly with ongoing Stage 2 RFP grid service procurements, and suggested changes to the modeling methodology that could reduce potential costs associated with conservative assumptions that could increase ratepayer costs.
- **IGP Transmission Planning Criteria:** Methodologies for emerging grid stability challenges with high levels of inverter-based resources (wind, solar, & storage), based on industry experience in California, Texas, and internationally - included a recommendation for control stability requirements and evaluation methods for the safe and reliable operation of new resources on the grid.
- **IGP Capacity Planning Criteria:** Implement reliability standards to properly evaluate reliability from standalone and hybrid battery energy storage assets.

Funding Source: Energy Systems Development Special Fund; Hawaii State Barrel Tax.

Contact: John Cole, colejohn@hawaii.edu, (808) 956-9390; Richard Rocheleau, rochelea@hawaii.edu, (808) 956-8346

Last Updated: October 2019

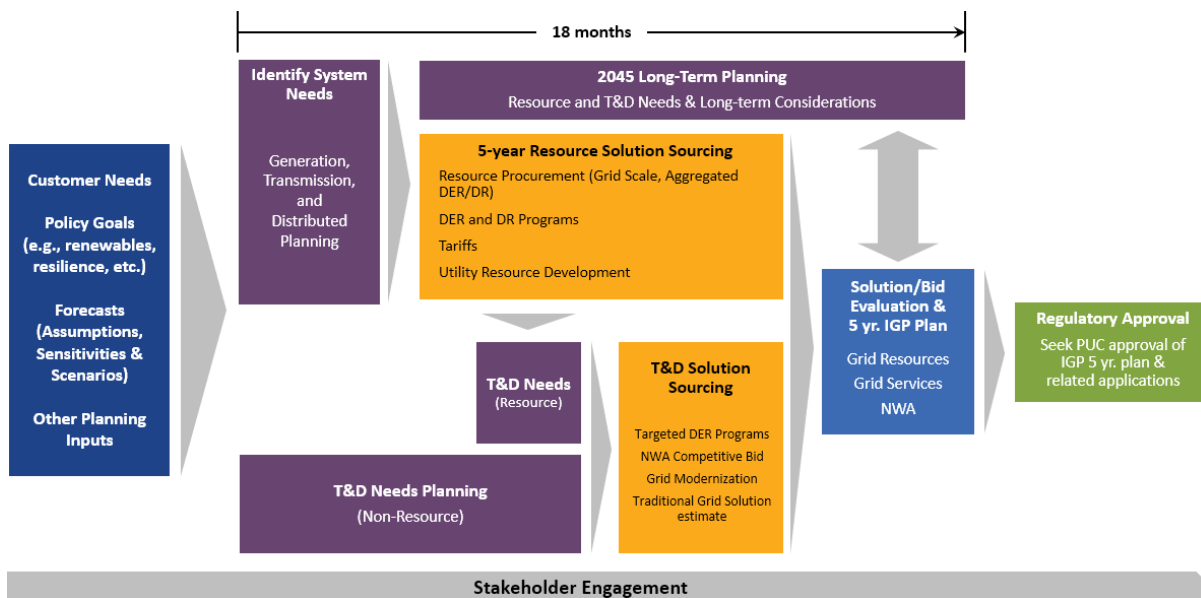

Figure 1. Source: Hawaiian Electric IGP Stakeholder Engagement Web Page <https://www.hawaiianelectric.com/clean-energy-hawaii/integrated-grid-planning/stakeholder-engagement>



Hawaii Natural Energy Institute Research Highlights

Hawaii Energy Analysis & Policy

Hawaii Energy Policy Forum

OBJECTIVE AND SIGNIFICANCE: Through this project HNEI supports the activities of the Hawaii Energy Policy Forum (HEPF) in its mission to enable informed decisions to advance Hawaii’s clean energy future by convening a network of stakeholders for fact finding, analysis, information sharing, and advocacy.

BACKGROUND: The HEPF was established in 2002 as a collaborative energy planning and policy group. The organization consists of roughly 40 representatives from the electric utilities, oil and natural gas suppliers, environmental and community groups, renewable energy industry, academia, and federal, state and local government. It is managed by the University of Hawaii College of Social Sciences. In its early years, the Forum was instrumental in several significant areas—including focusing priority and getting energy issues “on the decision-making table”, promoting funding and needed reform for the State’s utility regulatory agencies (i.e., the Public Utilities Commission and the Division of Consumer Advocacy), and commissioning studies, reports and briefings to raise the level of dialog concerning energy issues for legislators and the general public. The Forum sponsors and organizes several well attended annual events, including Hawaii Clean Energy Day, and a Legislative Briefing at the Capitol at the opening of each legislative session, and sponsors programs to develop reliable information and educate and raise awareness in the community. Two HNEI faculty members significantly contribute to HEPF activities, including sitting on the HEPF’s Steering Committee, chairing the Transportation and Electricity Working Groups, and hosting and coordinating the weekly Think Tech show.

PROJECT STATUS/RESULTS: During FY 2018-2019, HEPF focused on redeveloping its role, developing collaborative member-driven initiatives to help inform policy, diversifying its outreach activities, and launching a new website with legislative and docket proceeding resources for stakeholders and the general public. Specific new initiatives include:

Peer Exchange Program

HEPF is hosting peer exchanges (small group policy discussions) to encourage collaborative dialogue amongst members and non-members (including subject matter experts) to inform policy. In the

inaugural round, HEPF awarded three peer exchange proposals focused on transportation: 1) a mitigation-resilience-equity nexus approach, 2) implementing energy performance contracts for government fleets, and 3) transportation strategic energy planning. Outcomes and next steps will be shared with the public on HEPF’s website and at HEPF’s annual legislative briefing in January 2020.

Member Portal

A new online space for members to share information, ask questions, and coordinate meetings was developed. With enhanced communication tools and the ability to participate at one’s convenience, the Portal makes it easier for members to engage and collaborate with one another to help inform policy.

Outreach

- Sponsored 3 events - Hawaii Climate Change Conference, Bioeconomy Forum, and Maui Hawaii Energy Conference
- Sponsored the weekly “Hawaii: State of Clean Energy” series on ThinkTech Hawaii.

Website

HEPF launched a new website that houses updates on HEPF activities and various resources for energy stakeholders and the general public.

Information Resources

HEPF has created new resources for members and the public focusing on policy in the legislature and the PUC. In 2018-2019, six documents and databases were published.

Student Development

Through HEPF, two to three graduate students per semester and one undergrad web designer have been funded.

Funding Sources: Energy Systems Development Special Fund; Hawaii State Barrel Tax

Contact: John Cole, colejohn@hawaii.edu, (808) 956-9390; Mitch Ewan, ewan@hawaii.edu, (808) 956-2337, M: (832) 212-6129

Last Updated: October 2019



Hawaii Natural Energy Institute Research Highlights

Research/Focus Area (from website)

Project Title

OBJECTIVE AND SIGNIFICANCE: This project will inform a wider audience with accurate, easy to understand descriptions of analyses and issues related to Hawaii’s energy transition. The HNEI Energy Briefs are intended to engage an audience beyond just energy sector stakeholders, so they can understand and contribute to Hawaii’s renewable energy progress. These unbiased plain-language descriptions of the challenges, trade-offs, and issues associated with the transition will foster better understanding and informed discussion for both energy stakeholders and members of the public interested in learning more about these issues.

BACKGROUND: The HNEI Energy Briefs are a series of informative documents developed for the general public – each describing an aspect of Hawaii’s energy transformation challenges, possible solutions, and the methods used by HNEI to analyze and evaluate them. They will be supported by easily accessible materials, including more technical descriptions of methods, assumptions and analyses performed by HNEI.

Early energy briefs will focus on Oahu because its population and land scarcity make renewable growth additionally challenging, requiring deeper analysis.

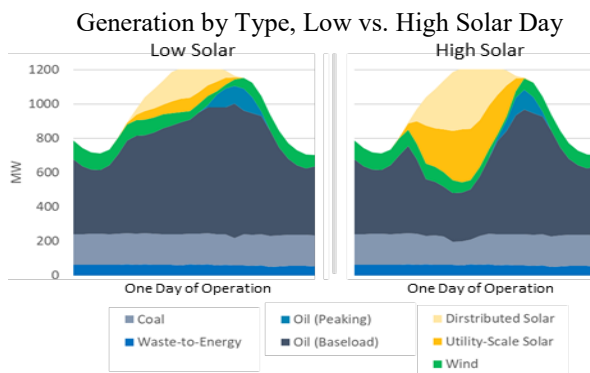

Figure 1

It is essential to maintain a reliable, affordable, and fair electricity system while we transition to 100% renewable energy. Since it is likely that the near-term new resources will be largely solar and storage, the initial Energy Briefs will identify

specific challenges with this course, evaluate their impacts, and analyze possible solutions.

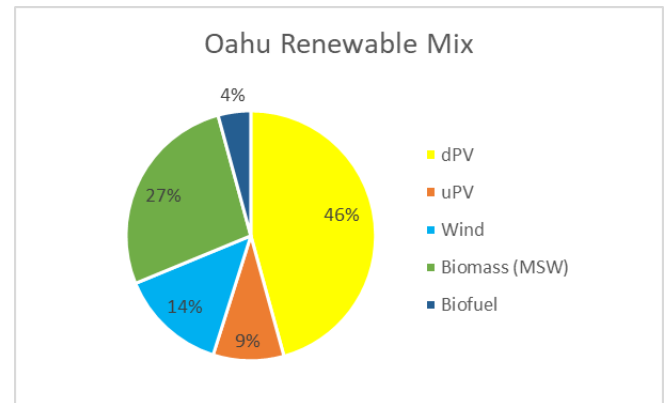

Figure 2

In addition to solar and storage, we will also address other enabling technologies that can play significant roles in the 100% renewable energy transition, including demand response, electric vehicle charging, and other distributed energy resources.

PROJECT STATUS/RESULTS: Initial Briefs include:

1. A Primer on Grid Operations and Planning
2. How are Wind and Solar Different?
3. Where is Hawaii in the Renewable Energy Transition?
4. Modeling & Simulation Methods for Hawaii’s Grids

Additional briefs will be published regularly and be available on the HNEI website.

Funding Source: Energy Systems Development Special Fund; Hawaii State Barrel Tax.

Contact: John Cole, colejohn@hawaii.edu, (808) 956-9390; Richard Rocheleau, rochelea@hawaii.edu, (808) 956-8346

Last Updated: November 2019



Hawaii Natural Energy Institute Research Highlights

Hawaii Energy Analysis & Policy

Grid Integration of Solar and Storage

OBJECTIVE AND SIGNIFICANCE: This project evaluates the Oahu grid’s ability to integrate increasing levels of solar and storage, and identifies potential challenges. In the near-term, storage can effectively mitigate oversupply of solar generation and curtailment risk, but even with substantial additions of battery storage, other solutions will be necessary to economically accommodate very high levels of solar energy.

In addition, the introduction of additional PV and storage will introduce stability and reliability challenges as new inverter-based technology is significantly different than conventional technology. Additional attention on these engineering challenges is necessary to ensure grid stability.

BACKGROUND: Over the past several years there has been a rapid growth of both distributed rooftop and utility-scale solar. As a result, there has been an oversupply of solar energy in the middle of the day, leading to potential curtailment risk. Increasingly, battery energy storage is being implemented to overcome oversupply and shift solar energy from mid-day and into evening peak and overnight periods. This is being done behind-the-meter, with home battery systems, as well as in the recently approved utility-scale solar plus storage projects. As the Oahu grid adds enough solar generation to approach 50% annual renewable energy, there is a risk of significant curtailment (Figure 1). This level would be approximately an additional 2,000 GWh, or 800 MW of new PV). Mitigations beyond four-hour storage will be needed. These can include oil and coal-fired generator retirements, and increased cycling capability and flexibility (either through thermal generation or load management and demand response).

PROJECT STATUS/RESULTS: Without grid modifications, curtailment starts to occur even with the storage additions. With 1500 GWh of additional solar, curtailment reaches 3.2%. More importantly, incremental curtailment of the last solar added exceeds 7%. These numbers increase to 58% and 20% respectively when 3500 GWh of additional PV are added. This trend clearly shows that while storage will delay PV curtailment, it will not eliminate the need for other mitigations to make the grid more

flexible. In this example, grid mitigations include the retirement of the AES coal plant and ability for the baseload steam oil units to cycle offline or turn down to lower loading levels, and additional load flexibility.

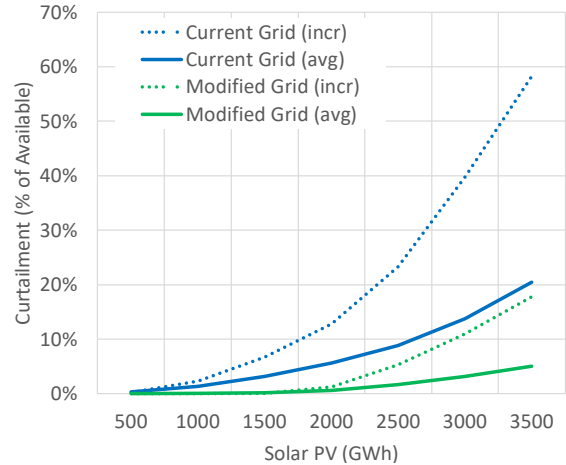

Figure 1. Curtailment with additional PV + 4-hour storage

Most of this curtailment is not driven by the lack of enough storage capacity to “shift” the PV generation, but rather “space” on the grid to discharge the stored energy during peak load and overnight periods. At a certain point, the amount of solar energy saturates even the peak load and overnight periods and there is not enough “space” on the grid for the battery to discharge before the solar generation starts again the next day.

These results clearly show storage is beneficial for near-term solar growth, but additional grid modifications and other mitigations are required. In addition, additional evaluation of grid stability with increasing inverter-based resources, and reliability analysis related to retiring the legacy oil-fired generation is required.

Funding Source: Energy Systems Development Special Fund; Hawaii State Barrel Tax

Contact: John Cole, colejohn@hawaii.edu, (808) 956-9390

Last Updated: November 2019



Hawaii Natural Energy Institute Research Highlights

Hawaii Energy Analysis & Policy

Electric Vehicle Emissions Impacts in Hawaii

OBJECTIVE AND SIGNIFICANCE: This project analyzed the state’s overall CO2 emission impact with increasing PV growth and electric vehicle (EV) adoption. While EVs can improve CO2 emissions, the amount of overall CO2 reductions depends on the generation mix of the underlying grid, the time of vehicle charging, and the fuel economy of the vehicle replaced. Because Hawaii’s grids are largely oil-based, additional EV loads still have significant carbon emissions.

Significant carbon reductions can be achieved by further decarbonizing the power grid, and by targeting the replacement of low fuel economy vehicles with EVs. Incentives may be better targeted toward replacing lower MPG vehicles with EVs, and to use EV charging for load management and demand response.

BACKGROUND: Hawaii’s the power sector accounts for 32% of the annual CO2 emissions for the state, whereas transportation accounts for 58%. Therefore, it is critical to address transportation sector emissions, and the Electrification of transportation (EoT) has been identified as a key component to doing so.

While EVs have zero tailpipe emissions, they are not emissions-free. These indirect EV emissions depend on those of the electricity produced to charge the vehicle. Unlike on the mainland, where EVs have shown a significant emissions benefit, Hawaii’s current largely oil-fired generation reduces the emissions benefit of EVs.

PROJECT STATUS/RESULTS: Currently Oahu does significantly curtail solar generation, and it is expected that near-term, the grid will be able to accommodate additional solar growth. As a result, additional EV charging loads will be incrementally served by increased oil-fired generation - even for homeowners who own both rooftop solar and an EV - because absent the new EV load, that solar energy would have gone directly to the grid and used to offset oil generation. Because of this, replacing the average Hawaii vehicle with a hybrid has more emission benefits than an EV (Figure 1). Policies could be implemented to incentivize the replacement of lower mileage vehicles to increase the emission reduction benefits.

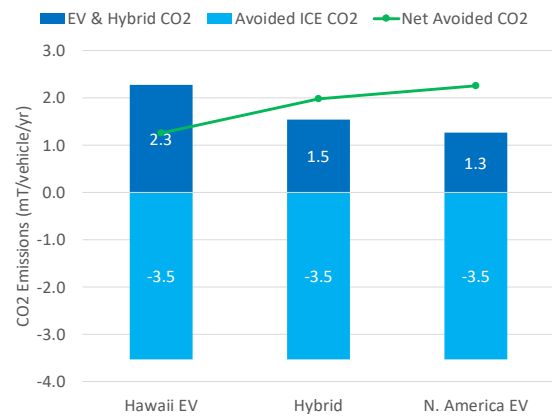

Figure 1. CO2 emissions comparison

It is not until the grid is more fully decarbonized that the emissions savings from an EV are higher. As PV generation increases, so does the underlying emissions benefits (Figure 2). In addition, EV charging can be utilized as an effective load management tool, providing valuable grid services. This would allow for further PV adoption and improved emissions benefits.

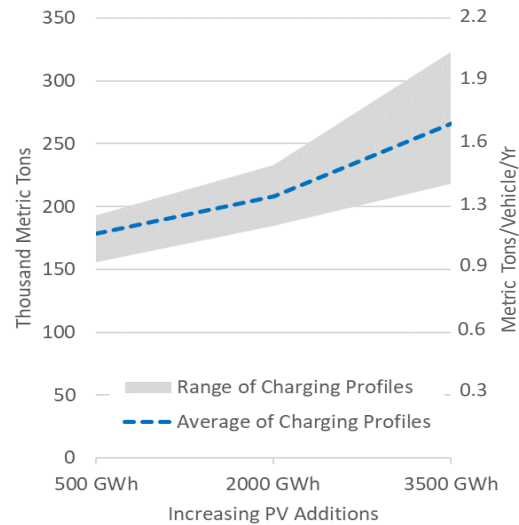

Figure 2. CO2 emissions reductions with increasing PV

Funding Source: Energy Systems Development Special Fund; Hawaii State Barrel Tax

Contact: John Cole, colejohn@hawaii.edu, (808) 956-9390

Last Updated: October 2019



Hawaii Natural Energy Institute Research Highlights

International Support

EGAT Renewable Integration Study

OBJECTIVE AND SIGNIFICANCE: HNEI Grid**START** is collaborating with the Electricity Generating Authority of Thailand (EGAT), the utility responsible for generation and transmission of power throughout Thailand, to conduct a renewable energy (RE) integration study for the country and enhance the professional capacity of its engineers in advanced study methods and tools.

BACKGROUND: The collaboration is pursuant to a Memorandum of Understanding (MOU) executed by HNEI and EGAT (see Figure 1) that is focused on a range of research, development and capability enhancements of mutual interest and benefit.



Figure 1. HNEI-EGAT MOU signing ceremony held on February 28, 2018, at EGAT’s corporate headquarters in Bangkok, Thailand.

Activities include constructing a high-fidelity production cost model of the Thai power grid and assessing the operational and economic impact of high penetration solar photovoltaic (PV) scenarios over a five to ten year planning horizon. Focus is on determining Thai-grid appropriate flexibility measures and evaluating their effectiveness in mitigating RE grid impacts. After a calibrated model of the Thai power grid is developed, Grid**START** and EGAT will jointly conduct modeling with personnel visits to Thailand and Hawaii, empowering EGAT engineers to conduct such analyses and more on its own going forward.

High levels of RE pose grid challenges due to its intermittency and variability and the limited capability of legacy power systems to flexibly respond by changes in unit commitment and dispatch to balance system net load. To maintain generation load balance and frequency control, conventional generation may need to ramp more quickly over a

wider-range to effectively balance short-term load changes and the variability and uncertainty of RE resource production. The production cost of dispatched generation may also increase due to less efficient operation and the need for increased operating reserves. Symptoms of increased frequency and voltage variability may appear when reliable grid operation is at risk, with possible degradation in power quality and other detrimental consequences. Thailand’s current level of PV and wind resources have yet to give rise to serious operational and economic concerns. However, the market for RE additions in Thailand is rapidly growing, and EGAT is prudent in its effort to swiftly build the knowledge, tools and capacity to study and evaluate high penetration RE scenarios consistent with Thai energy policy and plans for increased RE penetration.

PROJECT STATUS/RESULTS: Grid**START** and EGAT built and calibrated a high-fidelity production cost model of the Thai power grid in PLEXOS. In May 2019, HNEI held a multi-day workshop in Bangkok focused on model build, tuning and calibration, and presented model validation results.

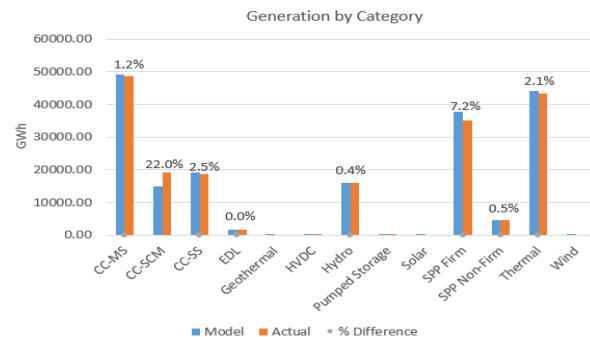

Figure 2. Model Validation Results

Development of time series PV and wind data sets for all existing RE plants and future high penetration RE scenarios (including large additions of distributed PV) are nearly complete. Applying the model to assess flexibility counter-measures to grid impacts of high RE and will be underway before year-end 2019.

Funding Source: Office of Naval Research, APRESA

Contact: Leon Roose, lroose@hawaii.edu, (808) 956-2331

Last Updated: November 2019



Hawaii Natural Energy Institute Research Highlights

International Support

U.S. India Collaborative for Smart Distribution with Storage (UI-ASSIST)

OBJECTIVE AND SIGNIFICANCE: The project objective is to foster collaboration around smart grids, particularly distribution systems and microgrids with solar photovoltaics (PV) and energy storage. University of Hawaii (UH) is among an esteemed group of institutions from the U.S. and India including Washington State University (WSU), Massachusetts Institute of Technology (MIT), Texas A&M University, General Electric, ABB, numerous U.S. DOE laboratories, and peer organizations in India including five Indian Institute of Technology (IIT) campuses. This project is an important opportunity to highlight Hawaii’s challenges and solutions as a “postcard from the future” with respect to renewable energy, while inviting input from international leaders in smart grid research and technology development.

BACKGROUND: HNEI GridSTART has several specific roles and objectives in the larger project:

- To provide models and data from distribution circuits with high distributed PV penetration as a basis to explore advanced devices, controls and distribution system operation (See Figure 1);
- To operate these models on HNEI GridSTART hardware-in-the-loop (HIL) equipment linked in real time to devices and controls at, for instance, WSU and the National Renewable Energy Laboratory (NREL) as a means to provide realistic testing in a controlled environment;
- To provide streams of PV data and corresponding multi-horizon PV forecasts from HNEI’s solar forecasting system (contact Dr. Dax Matthews) to validate both the solar PV forecasts and optimal controls that use the forecasts; and
- To provide outreach and workforce development addressing smart grid technologies and applications and renewable energy grid integration.

PROJECT STATUS/RESULTS: As of year two of the five year project, UH researchers and postdoctoral fellows have:

- Created tools to integrate Hawaii distribution circuit models for real-time simulation (Fig. 1);
- Co-authored a paper on PV/load disaggregation, submitted to IEEE Transactions journal;

- Hosted two professors from IIT as part of a U.S.-India Partnership to Advance Clean Energy (PACE) fellowship;
- Presented parts of two webinars to the team; and
- Prepared an exhibit attended by approximately 1,000 Hawaii K-12 students (See Figure 2).

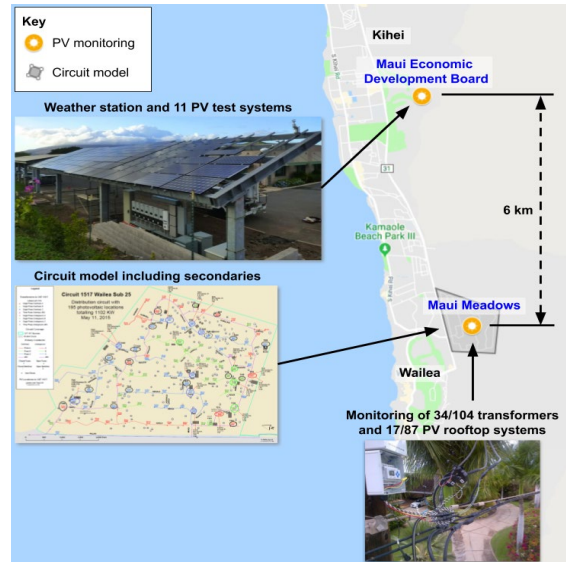

Figure 1. Overview of HNEI’s data and models from the area of South Kihei, Maui (presented at 2019 UI-ASSIST annual meeting)

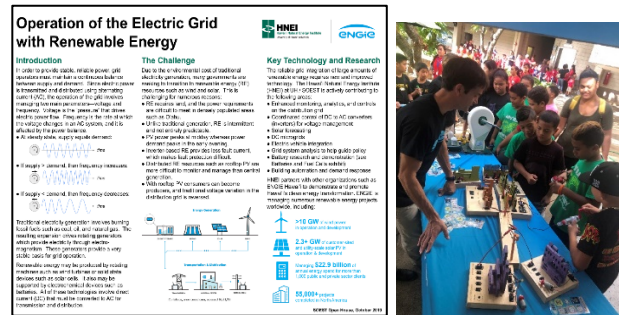

Figure 2. Poster and part of display presented to K-12 students at the 2019 SOEST Open House on the UH Manoa campus

Funding Source: U.S. Department of Energy (subaward from Washington State University); in-kind cost share from UH faculty salary and fringe

Contact: Kevin Davies, kdavies@hawaii.edu, (808) 956-3180

Last Updated: November 2019



Hawaii Natural Energy Institute Research Highlights

International Support

Vietnam Low Emission Energy Program (V-LEEP) RPS Development

OBJECTIVE AND SIGNIFICANCE: Under this project, HNEI, in collaboration with the National Renewable Energy Laboratory (NREL) is advising and guiding Vietnam’s Ministry of Industry and Trade (MOIT) and other Vietnamese stakeholders with the design of a Renewable Energy Portfolio Standard (RPS) mechanism and roadmap for its implementation. The project offers a replicable structure and framework for evaluating best practices for renewable policy development in this rapidly growing economic region.

BACKGROUND: This effort, conducted in support of the US AID funded V-LEEP involved analysis and development of a design and implementation roadmap for an RPS to increase deployment of renewable energy projects in Vietnam. Based on research of the Vietnam power sector and power market reforms and other announced changes, HNEI and NREL assessed international RPS models, identified best practices applicable to Vietnam and prepared a draft RPS roadmap. That was followed by public and private sector consultations to seek input on findings and approaches in support of Vietnam’s renewable energy development system (REDS) action plan.

PROJECT STATUS/RESULTS: Key outcomes of this effort included the following work products: presented to the V-LEEP Program leadership team:

- A report of international leading practices for RPS policies co-authored with NREL, <https://www.nrel.gov/docs/fy19osti/72798.pdf>
- A written administrative and monitoring structure for a Vietnam RPS featuring a planning and reporting strategy and accounting, enforcement, flexibility mechanisms and cost recovery components largely based on Hawaii’s structure and experience.
- Outreach, advisory meetings and discussions of all V-LEEP work products above with MOIT and other national executive branch agencies and jurisdictions, utilities, and energy stakeholders during the week of 13-18 March 2019 in Hanoi and Ho Chi Minh City, and subsequent mission report.

The mission report and draft Vietnam RPS implementation roadmap of the project findings will help inform HNEI’s broader role in supporting EREA on Vietnam’s energy transition under a bilateral Memorandum of Understanding executed on October 25, 2019.

Funding Source: Office of Naval Research, APRESA

Contact: Mark B. Glick, mbglick@hawaii.edu, (808) 956-2339

Last Updated: November 2019

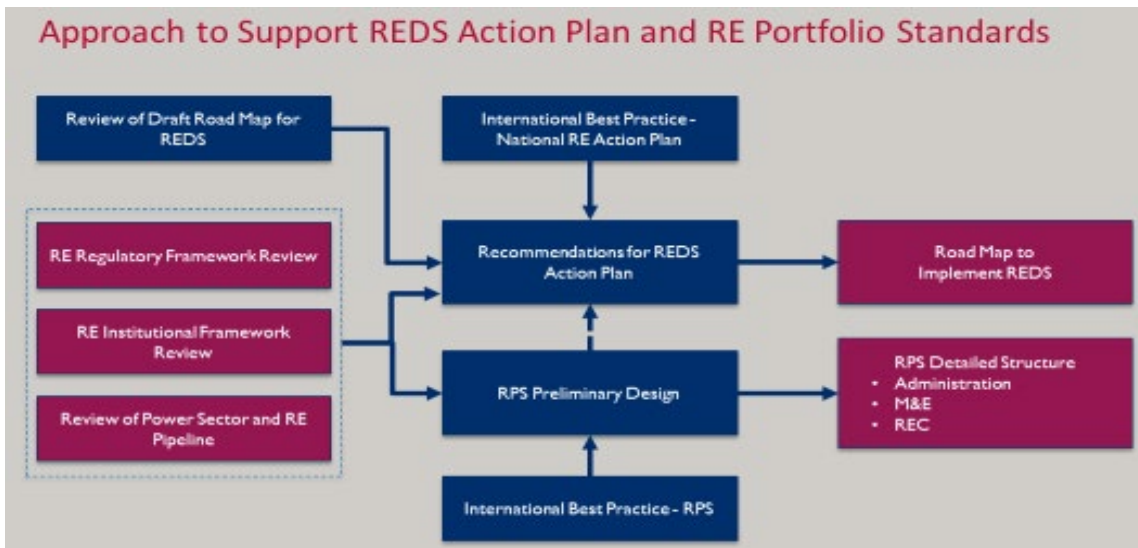



Hawaii Natural Energy Institute Research Highlights

International Support

Development & Verification of AI-based Microgrid Platform & Business Model

OBJECTIVE AND SIGNIFICANCE: The goal of this active project is to upgrade and improve the resilience of the electrical system for the deep seawater delivery facilities at the Natural Energy Laboratory of Hawaii (NELHA). More specifically, an advanced control system for an AI-based microgrid incorporating distributed solar and energy storage will be developed to optimize energy management, reduce costs, and improve resilience of the NELHA seawater distribution system.

BACKGROUND: The project is located within the 4,000-acre Hawaii Ocean Science & Technology (HOST) Park where more than 40 companies operate business/pilot sites. NELHA owns a research institute and seawater pump facility within the HOST Park. Interruptions in electrical service outages have the potential to irreparably damage the businesses that depend on the seawater for their agricultural and production requirements. This project is intended to reduce utility costs and protect the seawater pumping system from potential outages through the installation of an AI-based renewable microgrid.

The Hawaii Natural Energy Institute (HNEI) initiated efforts to apply for Korea Institute of Energy Technology Evaluation and Planning (KETEP) grant funding and assembled a consortium of United States and Korean entities to pursue the microgrid development project with NELHA.

KETEP awarded the project team a grant of KrW 1,940 million, approximately USD 1.73 million via the Korea Ministry of Trade, Industry, and Energy as part of their International Energy Collaborative Research and Development Program. The project entails a detailed design, deployment, testing and evaluation of a microgrid that includes photovoltaic (PV) panels and energy storage systems (ESS) at NELHA’s research campus seawater pump stations. The project period is November 1, 2018 through April 30, 2021.

PROJECT STATUS/RESULTS: To date, HNEI has supported the microgrid development project by clarifying requirements for grid interconnection between the proposed NELHA microgrid and the HELCO grid; developing functional requirements and use cases for the microgrid; and supporting the project team in the open docket by the Hawaii Public Utilities Commission to establish a microgrid services tariff and process under which microgrids can be interconnected to Hawaii’s electric grids.

Funding Source: KETEP (subcontract with Encored, Inc.)

Contact: Mark B. Glick, mbglick@hawaii.edu, (808) 956-2339

Last Updated: October 2019

Microgrid Operation

On-grid operation

Short-term compensation for failure of forecasting

