

DAVID Y. IGE  
GOVERNOR



ARTHUR J. LOGAN  
MAJOR GENERAL  
ADJUTANT GENERAL

KENNETH S. HARA  
BRIGADIER GENERAL  
DEPUTY ADJUTANT GENERAL

STATE OF HAWAII  
**DEPARTMENT OF DEFENSE**  
**OFFICE OF THE ADJUTANT GENERAL**  
3949 DIAMOND HEAD ROAD  
HONOLULU, HAWAII 96816-4495

A. The mission of the State of Hawaii Department of Defense, which includes the Hawaii National Guard (HING) and Hawaii – Emergency Management Agency (HIEMA), is to assist authorities in providing for the safety, welfare, and defense of the people of Hawaii. The department maintains its readiness to respond to the needs of the people in the event of disasters, either natural or human- caused. The Office of Veterans Services (OVS) serves as the single point of contact in the state government for veterans’ services, policies, and programs. The OVS also oversees eight Hawaii State Veterans Cemeteries. The Hawaii National Guard Youth Challenge Academy provides at-risk-youth with an opportunity to complete their high school education while learning discipline and life-coping skills.

B. The Department does not have any significant conditions affecting our ability to meet our state mission.

C. Federal Funds: The Department’s Federal funds budget is ~\$84.0 million with a \$105.4 million total operating budget for FY2019. The federal funds are distributed through the National Guard Bureau based upon the Master Corporate Agreement for the various contracted programs. The federal funds associated with the U.S. Department of Defense is not in jeopardy of being lost. However, federal funds available through the Grant program has reduced over the years. These anticipated federal funds currently total \$6.6 million:

CFDA No.	Federal Award Title	FY19 Anticipated
97.056	Port Security Grant Program	\$ 1,000,000
97.067	Homeland Security Grant	\$ 4,000,000
97.067	Urban Areas Security Grant	\$ 1,500,000
97.008	Non-Profit Security Grant Program	\$ 150,000

D. \\g01dod-papp03\e\ASO\Legislative\Legislative Reports

E. The Department of Defense prioritizes its budget requests based on our ability to meet mission requirements and safety of our personnel and the people of Hawaii. Upon receipt of the Department of Budget and Finance’s Finance Memorandum 17-12 for supplemental budget preparation, the DOD takes the following actions:

1) ASO requests all programs to create and submit Operating Budget and Capital Improvement Project requests that meet the DB&F budget policies and guidelines.

2) ASO receives all program requests and reviews, clarifies and corrects all submissions, as needed.

Operating and CIP budget requests are recommended in priority order for the TAG’s review, modification and approval.

- 3) Final prioritized budget requests are compiled and submitted to B&F for review and approval by the submission deadline.
- 4) B&F questions and comments are fielded and responded to. B&F budget recommendations are received.
- 5) Appeal to Governor’s Office made for budget requests denied or amended by B&F, as required.
- 6) Approved budget requests are finalized and submitted to B&F for Legislative submittal by submission deadlines.

F. Major Adjustments contained in the budget request:

Item 1. HIARNG – Utilities and facilities maintenance Budget. This request is for anticipated increase in janitorial supplies and utilities rates and usage.

MOF A	FY 20	\$61,780	FY 21	\$61,780
MOF P	FY 20	\$185,338	FY 21	\$185,338

Item 2. HIANG – Utilities and facilities maintenance Budget. Request to increase utilities and facilities maintenance costs due to rate and contract cost increase.

MOF A	FY 20	\$48,371	FY 21	\$48,371
MOF P	FY 20	\$144,174	FY 21	\$144,174

Item 6. HIEMA – Administration Staff. Add 1.0 Perm HR Specialist for the Administration Staff. This position will work with HI-EMA leadership in the following areas: managing personnel documentation; recruiting and long term promoting professional development opportunities for the team; and other Management and administration of personnel related duties.

MOF A	FY 20	1.0 FTE/ \$26,478	FY 21	1.0 FTE/ \$52,956
-------	-------	-------------------	-------	-------------------

Item 8. CIO – upgrade Wi-Fi Access Point. Request funding to upgrade ageing Wi-Fi access points.

MOF A	FY 20	\$50,000
-------	-------	----------

Item 9. Hawaii State Veterans Cemetery – Excavator & Tractor. Request to purchase an Excavator with attachments (compactor, cemetery bucket, hoe-ram) and Utility Tractor with attachments (brush cutter, arm cutting) for the Hawaii State Veterans Cemetery.

MOF A	FY 20	\$125,000
-------	-------	-----------

Item 10. Convert Emergency Management Staff - From Federal to General Funds. To convert the Emergency Management Agency Funding from federal (N&P) to General funding. State emergency management is currently funded by combining state and federal funds in a fifty-fifty manner to meet daily operating costs. Doing so is hampering the effective management of the Hawaii Emergency Management Agency (HI-EMA) and coordination with County Emergency Management Agencies (EMAs) and State agency partners. The problem is that this funding structure is driving a substantial part of HI-EMA’s mission to prevent loss of federal funds rather than to best serve the Governor and Mayors in providing top quality emergency management.

MOF A	FY 20	8.5 Perm & 22 Temp/ \$2,003,603
	FY 21	8.5 Perm & 22 Temp/ \$2,003,603
MOF N	FY 20	-7.5 Perm & -11 Temp/ -\$2,022,049
	FY 21	-7.5 Perm & -11 Temp/ -\$2,022,049
MOF P	FY 20	-1.0 Perm & -11 Temp/ -\$903,930
	FY 21	-1.0 Perm & -11 Temp/ -\$903,930

Item 11. Emergency Management Staff – Disaster Staff. Hawaii had 2 presidentially declared disasters in FY 2018, April 2018 Severe Storms and May 2018 Kilauea East Rift Zone. Additional staffing is needed to process FEMA reimbursement requests of over \$51,000,000 in damages to the islands.

MOF A	FY 20	12 Temp/ \$620,664
	FY 21	12 Temp/ \$620,664

Item 12. Emergency Management Staff – Staff Reduction. Delete 1 Temporary Project coordinator due to the Project Ending.

MOF A	FY 20	-1.0 Temp/ -\$115,738
	FY 21	-1.0 Temp/ -\$115,738

Item 13. Youth Challenge Academy – Increase Meal & School Expenses. Request to increase Federal Expenditure ceiling & State funds to cover authorized increase of daily meal reimbursement rate for Youth Challenge programs and for additional expenditures to expand academic curriculum.

MOF A	FY 20	\$77,000	FY 21	\$77,000
MOF P	FY 20	\$231,000	FY 21	\$231,000

Item 21. HIEMA – Emergency Communications Infrastructure. Fixed and mobile hurricane resistant satellite and HF digital radio emergency communication equipment and network to be installed state-wide, all islands at State and County EOCs to provide backup stand-alone communications capable of withstanding major natural disasters.

MOF A	FY 20	\$145,650
MOF N	FY 20	\$428,100

Item 36. Major Disaster Fund. Hawaii had 2 presidentially declared disasters in FY 2018, April 2018 Severe Storms and May 2018 Kilauea East Rift Zone. This request is to provide funds for such Major Disaster in the State of Hawaii.

MOF A	FY 20	\$4,500,000	FY 21	\$4,500,000
-------	-------	-------------	-------	-------------

F. Highlights of the Executive CIP Budget Request: The Department requested - Seven (7) Capital Improvement Projects totaling in FY 20 a total of \$36.261 million in GO Bonds and \$8.263 million in Federal Funds and in FY 21 \$6.463 million in GO Bonds and \$7.456 million in Federal Funds.

1) VA Long – Term Care Facility. Design, construct, and Equip a new Long-Term Care State Veterans Home on the Island of Oahu.

MOF C	FY 20	\$31,783,000
MOF P	FY 20	\$3,717,000

2) Fort Ruger B306 and B306A, Hurricane Hardening. Retrofit Buildings at the Diamond Head Buildings (B306 & 306A) to resist Hurricane force winds, AC Improvements, New Emergency Generator and Associated Improvements.

MOF C	FY 20	\$665,000
	FY 21	\$1,240,000

3) Disaster Warning and Communications Devices, Statewide. Additional, replace or upgrade the State Civil Defense Warning and communication Equipment. This will expand the coverage and reliability of the Warning and control system, as well as modernize and alleviate siren coverage Gap areas.

MOF C	FY 20	\$2,500,000
-------	-------	-------------

4) Retrofit Public Buildings with Hurricane Protective Measures. Retrofit Buildings with Hurricane Protective Measures to increase the number of emergency shelters, Statewide.

MOF C	FY 21	\$3,000,000
-------	-------	-------------

5) Upgrades & Improvements to NG Readiness Centers and Facilities Statewide State and Federal Funds. Upgrade current National Guard Readiness Centers (Armories) and Facilities to conform to current National Guard Bureau, Department of the Army Standards and to meet Health, safety and Building Code Requirements.

MOF C	FY 21	\$2,096,000
MOF P	FY 21	\$7,456,000

6) Birkhimer Emergency Operation Center Security& Access Improvements State and Federal Funds. Birkhimer Emergency Operational Center (DOC) to upgrade Security Lighting, Perimeter signage, Realignment of Existing and installation of Perimeter Security Fencing and the installation of a Pedestrian stairs.

MOF C	FY 20	\$313,000
MOF P	FY 21	\$127,000

7) Hawaii State Veterans Cemetery Upgrade and improvement. Upgrade and Improve the Hawaii State Veterans Cemetery including the construction of a Double – Depth Lawn Crypts, improvements to the committal Shelter, installation of Security Systems at the Administration and Maintenance Buildings, and upgrade the irrigation system and other improvements.

MOF C	FY 20	\$4,546,000
-------	-------	-------------

If you have any questions or need additional information to our response, please contact our administrative services officer Rusty Spray at (808) 726-5599 or at [rusty.spray@hawaii.gov](mailto:rusty.spray@hawaii.gov)

ARTHUR J. LOGAN  
Major General, HING  
Adjutant General

Department of Defense  
Functions

Table 1

Division	Description of Function	Activities	Prog ID(s)	Statutory Reference
DEPARTMENTAL ADMINISTRATION	Executive management services and support services to the Department of Defense.	Office of the Adjutant General, Deputy Adjutant General and Special Staff such as the Inspector General, Military Executive Officer, Senior Enlisted Advisor & Joint Military Executive Officer. Support Services such as the Administrative Services Office, Human Resources Office, Secretarial Services, Public Affairs Office, Judge Advocate Office, Quality Office, Engineering Office,	DEF 110AA	HRS 26-21
HAWAII ARMY NATIONAL GUARD	The Hawaii Army National Guard (HANG) has dual Federal and State missions. In the Federal role, the HANG provides trained and qualified personnel for active duty in time of war or national emergency. In the State role, the HANG provides organized and trained units to protect Hawaii's people, preserves peace, and ensures public safety in response to natural and human-caused disasters. Provides command, control, and supervision of administration, training, operations, and logistics in preparing assigned units for their Federal and State mobilization missions.	Directs and coordinates the activities and units of the State Department of Defense, National Guard. 29th Separate Infantry Brigade, 298th Regiment, 2nd Battalion, 299th Infantry, 1st Battalion, 487th Field Artillery, 29th Support Battalion, 227th Engineering company (Combat), 229th MI Company, 103rd Troop Command, Company B & C, 193rd Aviation, Hi NG Capability Enhanced Combat Aviation Team (Medical), Reconnaissance & Interdiction Detachment, 25th Infantry division Detachment, POMSO, Counter Drug Support Program, Military Personnel Office, Plans, Operations and Training Office, Logistics/State Surface Maint Office, State Army Aviation Office, Safety & Occupational Health, Regional Training Site - Maint, Administration, Operations Drug Demand Reductions.	DEF 110AB	HRS 26-21
HAWAII AIR NATIONAL GUARD	The Hawaii Air National Guard (HIANG) has dual Federal and State missions. In the Federal role, the HIANG provides trained and qualified personnel for active duty in time of war or national emergency. In the State role, the HIANG provides organized and trained units to protect Hawaii's people, preserves peace, and ensures public safety in response to natural and human-caused disasters.	Directs and coordinates the activities and units of the State Department of Defense Air National Guard Division. Headquarters 154th Wing, 154th Operations Group, 199th Fighter Squadron, 203rd Air Refueling Squadron, 204th Airlift Squadron, 150th Aircraft Control and Warning Flight, 154th Air Control Squadron, 169th Aircraft Control and Warning Squadron, 154th Operations Support Flight, 154th Logistics Group, 154th Logistics Squadron, 154th Maintenance Squadron, 154th Aircraft Generation Squadron, 154th Logistics Support Flight, 154th Support Group, 154th Civil Engineering Squadron, 154th Mission Support Flight, 154th Services Flight, 154th Security Forces Squadron, 154th Communications Flight, 154th medical Squadron, 199th Weather Flight, 201st Combat Communications Group, 291st Combat Communications Squadron, 292nd Combat Communications Squadron, 293rd Combat Communications Squadron, 297th Air Traffic Control Squadron.	DEF 110AC	HRS 26-21
HAWAII EMERGENCY MANAGEMENT AGENCY	The Civil Defense Division assists the Hawaii Ohana prepare for, respond to and recover from disasters.	Administers and directs the Civil Defense Division in planning, programming, preparing, organizing, and training for the purpose of minimizing loss of life and property within the state due to man-made and natural disasters. External Affairs Section, Outreach unit, Support Branch, Finance and administrative Section, Logistics section, Facilities Engineering Unit Warehouse Unit, Pacific Disaster Center Program, Preparedness Branch, Training and Exercise Section, Planning Section, Hazard Mitigation Unit, Earthquake Unit, Hurricane Unit, Operations Branch, Current Operations Section, Future Operations Section, Disaster Assistance Section, Infrastructure Unit, Human Services Unit, Disaster Recovery Unit, Communication Branch, Information Technology Section, Siren Support Unit,	DEF 110AD	HRS 26-21

Department of Defense  
Functions

Table 1

<u>Division</u>	<u>Description of Function</u>	<u>Activities</u>	<u>Prog ID(s)</u>	<u>Statutory Reference</u>
SERVICES TO VETERANS	<p>The Office of Veterans Services (OVS), administratively assigned to the State Department of Defense, is the principal agency in State government responsible for the administration, conduct and coordination of all functions and activities prescribed under Chapter 363, Veterans Rights and Benefits', HRS.</p> <p>This OVS also provides functional oversight to the eight State Veterans Cemeteries (Kaneohe, Kauai, Maui, Lanai, Molokai, East Hawaii 1 and East Hawaii 2 in Hilo, and West Hawaii in Kona) located on six major islands.</p>	<p>Serves as the principal official in state government responsible for the development, performance and control of programs on behalf of veterans and their dependents. Administrative Services Section, Office Services Section, Veterans Services Branch, Veterans Services sections (Hawaii, Kauai, Maui and Oahu) and the Hawaii State Veterans Cemetery Branch.</p>	DEF 112VA	HRS 26-21
HAWAII NATIONAL GUARD YOUTH CHA	<p>The Hawaii National Guard Youth Challenge Program (HINGYCP) is part of a nation-wide strategy to assist qualified high school dropouts, ages 16 &amp; 18, to participate in each of two five-month residential programs leading to the completion of a General Education Development (GED) or a Competency Based High School Diploma (CB) supplemented with comprehensive work and life skills attainment.</p>	<p>Advisory Committee, office of the Director, Secretarial/Clerical Services, Administrative/Logistical Branch, Supply Staff, Food Services Section, Health Service Staff, Security Section, Custodial/Maintenance Staff, Accounting Staff, Program Branch, Educational Section, Counseling Section Residential Training Section, and Recruitment/Placement Staff.</p>	DEF 114YC	HRS 26-21

Department of Defense  
Department-Wide Totals

Table 2

Fiscal Year 2019				
Act 53/18 Appropriation	Restriction	Emergency Appropriations	Total FY18	MOF
\$ 21,719,735	\$ (828,885)		\$ 20,890,850	A
\$ 10,759,428			\$ 10,759,428	N
\$ 72,881,232			\$ 72,881,232	P
			\$ -	
			\$ -	
			\$ -	
\$ 105,360,395	\$ (828,885)	\$ -	\$ 104,531,510	Total
Fiscal Year 2020				
Act 53/18 Appropriation	Reductions	Additions	Total FY19	MOF
\$ 21,719,735	\$ (2,319,000)	\$ 598,925	\$ 19,999,660	A
\$ 10,759,428			\$ 10,759,428	N
\$ 72,881,232			\$ 72,881,232	P
			\$ -	
			\$ -	
			\$ -	
\$ 105,360,395	\$ (2,319,000)	\$ 598,925	\$ 103,640,320	Total
Fiscal Year 2021				
Act 53/18 Appropriation	Reductions	Additions	Total FY19	MOF
\$ 21,719,735	\$ (2,319,000)	\$ 645,509	\$ 20,046,244	
\$ 10,759,428			\$ 10,759,428	
\$ 72,881,232			\$ 72,881,232	
			\$ -	
			\$ -	
			\$ -	
\$ 105,360,395	\$ (2,319,000)	\$ 645,509	\$ 103,686,904	Total



Department of Defense  
Program ID Totals

Table 3

Prog ID	Program Title	MOF	As budgeted in Act 53/18 (FY19)			Governor's Submittal (FY20)				Governor's Submittal (FY21)			
			Pos (P)	Pos (T)	\$\$\$	Pos (P)	Pos (T)	\$\$\$	Percent Change of \$\$\$\$	Pos (P)	Pos (T)	\$\$\$	Percent Change of \$\$\$\$
DEF 110AA	DEPARTMENTAL ADMINISTRATION	A	93.75	5.25	8,848,661	94.75	5.50	12,372,340	40%	94.75	5.50	12,374,338	40%
DEF 110AA	DEPARTMENTAL ADMINISTRATION	N	2.00	3.00	5,042,445	2.00	3.00	5,042,445	0%	2.00	3.00	5,042,445	0%
DEF 110AA	DEPARTMENTAL ADMINISTRATION	P	19.25	0.75	7,346,860	19.25	1.50	7,421,769	1%	19.25	1.50	7,421,769	1%
DEF 110AB	HAWAII ARMY NATIONAL GUARD	A	11.50		2,829,678	11.50	-	2,869,268	1%	11.50	-	2,871,583	1%
DEF 110AB	HAWAII ARMY NATIONAL GUARD	P	50.50		31,622,566	50.50	31.00	31,807,904	1%	50.50	31.00	31,807,904	1%
DEF 110AC	HAWAII AIR NATIONAL GUARD	A	9.25		2,058,824	9.25	-	2,084,810	1%	9.25	-	2,086,611	1%
DEF 110AC	HAWAII AIR NATIONAL GUARD	P	24.75		6,697,524	24.75	-	6,841,698	2%	24.75	-	6,841,698	2%
DEF 110AD	HAWAII EMERGENCY MANAGEMENT AGENCY	A	19.50	38.00	3,964,628	28.00	71.75	6,328,104	60%	28.00	71.75	6,193,092	56%
DEF 110AD	HAWAII EMERGENCY MANAGEMENT AGENCY	N	7.50	11.00	5,716,983	-	-	4,123,034	-28%	-	-	3,694,934	-35%
DEF 110AD	HAWAII EMERGENCY MANAGEMENT AGENCY	P	1.00	13.00	21,850,320	-	0.25	20,755,743	-5%	-	0.25	20,755,743	-5%
DEF 112VA	SERVICES TO VETERANS	A	28.00		2,832,321	28.00		2,220,178	-22%	28.00		2,101,486	-26%
DEF 114YC	HAWAII NATIONAL GUARD YOUTH CHALLENGE ACADEMY	A		24.50	1,706,507		24.50	1,783,507	5%	24.50		1,783,507	5%
DEF 114YC	HAWAII NATIONAL GUARD YOUTH CHALLENGE ACADEMY	P		73.50	5,363,962		73.50	5,594,962	4%	73.50		5,594,962	4%
	AMELIORATION OF PHYSICAL DISASTERS												

Department of Defense  
Budget Decisions

Table 4

Prog ID	Sub-Org	Description of Request	MOF	Initial Department Requests						Budget and Finance Recommendations						Governor's Decision									
				FY20			FY21			FY20			FY21			FY20			FY21						
				Pos (P)	Pos (T)	\$\$\$	Pos (P)	Pos (T)	\$\$\$	Pos (P)	Pos (T)	\$\$\$	Pos (P)	Pos (T)	\$\$\$	Pos (P)	Pos (T)	\$\$\$	Pos (P)	Pos (T)	\$\$\$	Pos (P)	Pos (T)	\$\$\$	
DEF110	AA	To correct an error - Act 53, SLH 2018, DEF110 (1.00 position #118318 was deleted seq 3000-001 from DEF110AA, which should have been from DEF110AD).	A							0.25	15,606		0.25	15,606		0.25	15,606		0.25	15,606		0.25	15,606		
DEF110	AD	To correct an error - Act 53, SLH 2018, DEF110 (1.00 position #118318 was deleted seq 3000-001 from DEF110AA, which should have been from DEF110AD).	A							(0.25)	(15,606)		(0.25)	(15,606)		(0.25)	(15,606)		(0.25)	(15,606)		(0.25)	(15,606)		
DEF110	AA	To correct an error - Act 53, SLH 2018, DEF110 (1.00 position #118318 was deleted seq 3000-001 from DEF110AA, which should have been from DEF110AD).	P							0.75	74,909		0.75	74,909		0.75	74,909		0.75	74,909		0.75	74,909		
DEF110	AD	To correct an error - Act 53, SLH 2018, DEF110 (1.00 position #118318 was deleted seq 3000-001 from DEF110AA, which should have been from DEF110AD).	P							(0.75)	(74,909)		(0.75)	(74,909)		(0.75)	(74,909)		(0.75)	(74,909)		(0.75)	(74,909)		
DEF110	AB	HIARNG - Utilities and facilities maintenance increase & update	A			91,000			91,000			61,780			61,780			61,780			61,780			61,780	
DEF110	AB	HIARNG - Utilities and facilities maintenance increase & update	P			273,000			273,000			185,338			185,338			185,338			185,338			185,338	
DEF110	AC	HIANG -increase utilities and facilities maintenance costs	A			48,371			49,969			48,371			48,371			48,371			48,371			48,371	
DEF110	AC	HIANG -increase utilities and facilities maintenance costs	P			144,174			148,968			144,174			144,174			144,174			144,174			144,174	
DEF110	AA	HIENG -State Engineering and Maintenance Requirements	A			164,300			169,229			-			-			-			-			-	
DEF110	AA	Chief Information Officer - Funding for operational costs - office supplies, computer related supplies, recurring software licenses and subscriptions, and hardware	A			46,000			46,000			-			-			-			-			-	
DEF110	AA	Homeland Security - Cyber Analysts for Hawaii State Fusion Center	A	2.00		180,000	2.00		180,000			-			-			-			-			-	
DEF110	AD	HIEMA - Emergency Management Agency Staffing - Administration Staff	A		2.00	52,956		2.00	105,912																
DEF110	AA	HIEMA - Emergency Management Agency Staffing - Administration Staff	A							1.00		26,478	1.00		52,956	1.00		26,478	1.00		52,956			52,956	
DEF110	AA	Homeland Security - Equipment for Office of Homeland Security	A						141,500																
DEF110	AA	Chief Information Officer - upgrade aging Wi-Fi access points	A			50,000						50,000						50,000							
DEF112	VA	Office of Veteran Services - Hawaii State Veterans Cemetary-Excavator and Utility Tractor w/Attachments	A			125,000						-						125,000							
DEF110	AD	HIEMA - Emergency Management Staff Funding	A	8.50	22.00	2,003,603	8.50	22.00	2,003,603	8.50	22.00	2,003,603	8.50	22.00	2,003,603	8.50	22.00	2,003,603	8.50	22.00	2,003,603	8.50	22.00	2,003,603	
DEF110	AD	HIEMA - Emergency Management Staff Funding	N	(7.50)	(11.00)	(2,022,049)	(7.50)	(11.00)	(2,022,049)	(7.50)	(11.00)	(2,022,049)	(7.50)	(11.00)	(2,022,049)	(7.50)	(11.00)	(2,022,049)	(7.50)	(11.00)	(2,022,049)	(7.50)	(11.00)	(2,022,049)	
DEF110	AD	HIEMA - Emergency Management Staff Funding	P	(1.00)	(11.00)	(903,930)	(1.00)	(11.00)	(903,930)	(1.00)	(11.00)	(903,930)	(1.00)	(11.00)	(903,930)	(1.00)	(11.00)	(903,930)	(1.00)	(11.00)	(903,930)	(1.00)	(11.00)	(903,930)	
DEF110	AD	HIEMA - Emergency Management Agency Staffing - disaster positions	A		12.00	620,664		12.00	620,664			12.00	620,664			12.00	620,664			12.00	620,664			12.00	620,664
DEF110	AD	HIEMA - Emergency Management Agency Staffing - Administration Staff	P		(1.00)	(115,738)		(1.00)	(115,738)			(1.00)	(115,738)			(1.00)	(115,738)			(1.00)	(115,738)			(1.00)	(115,738)
DEF114	YC	Youth Challenge Academy-Increases in meal contract & school expenses	A			93,493			93,493			77,000			77,000			77,000			77,000			77,000	
DEF114	YC	Youth Challenge Academy-Increases in meal contract & school expenses	P			280,479			280,479			231,000			231,000			231,000			231,000			231,000	
DEF110	AB	HIARNG -Establish new, 100% federally funded Engineer IV	P	1.00		103,033			103,033																
DEF110	AA	HIENG - General Laborer I, II, and III - Hilo	A	3.00		136,460	3.00		62,850																
DEF110	AA	HIENG - General Laborer I, II, and III - Hilo	P			100,560			100,560																
DEF110	AA	Chief Information Officer - IT Help Desk Position	A	1.00		50,000	1.00		50,000			-			-			-			-			-	

Department of Defense  
Budget Decisions

Table 4

Prog ID	Sub-Org	Description of Request	MOF	Initial Department Requests				Budget and Finance Recommendations				Governor's Decision				
				FY20	FY21	FY20	FY21	FY20	FY21	FY20	FY21					
DEF110	AA	Chief Information Officer - Install communications hardware and cables at Starbase Hawaii	A		4,200											
DEF110	AA	Chief Information Officer - upgrade Internet service	A		4,080		4,080									
DEF110	AA	Joint Operation Center - Emrg Op Sp	A	2.00	105,912	2.00	105,912			-		-				
DEF112	VA	Office of Veteran Services - Overtime Support for Governor's Ceremonies	A		22,500		22,500			-		-				
DEF110	AD	HI-EMA Emergency Communications Infrastructure	A		145,650		48,204			145,650				145,650		
DEF110	AD	HI-EMA Emergency Communications Infrastructure	N		428,100					428,100				428,100		
DEF114	YC	Youth Challenge Academy-White House Job Driven Training Initiative Funds	A		50,000		50,000			-		-				
DEF114	YC	Youth Challenge Academy-White House Job Driven Training Initiative Funds	P		150,000		150,000			-		-				
DEF110	AA	Homeland Security - Equipment for Senesitive Compartmented Information facility(SCIF)	A				138,800			-		-				
DEF112	VA	Office of Veteran Services - Hawaii State Veterans Cemetary- Regrade Slope and Grass Area	A		28,000					-		-				
DEF112	VA	Office of Veteran Services - Hawaii State Veterans Cemetary- Clean-out Still Basin and Drainage Channel	A		55,200					-		-				
DEF112	VA	Office of Veteran Services - Hawaii State Veterans Cemetary- Clear, regrade and re-establish hillside terraces and drainage swales	A		220,500					-		-				
DEF110	AD	HI-EMA Access Control System	A		110,000											
DEF110	AA	Chief Information Officer - install INET fiber from bldg. 306 to bldg. 90	A		13,600											
DEF110	AA	Chief Information Officer - install INET fiber - Kalaeloa	A		5,247					-						
DEF110	AA	Chief Information Officer - install INET fiber Keaukaha Military Reservation, Hilo.	A		14,000											
DEF110	AA	Chief Information Officer - install INET fiber Joint Base Pearl Harbor Hickam	A		207,331											
DEF110	AA	HIENG - Repairs and Maintenance of DOD State Buildings and Structures, Statewide - Special Maintenance	A		58,000		420,000			-		58,000				
DEF110	AA	HIENG - New Electrician I & Pick-up Utility Vehicle	A	1.00	134,150	1.00	99,150			-		-				
DEF110	AA	HIENG - Trailers-Replacements	A		27,700					-						
DEF110	AA	Homeland Security - state cyber safety community outreach program	A		9,000		9,000			-						
DEF110	AA	Major Disaster Fund	A							4,500,000		4,500,000		4,500,000		4,500,000

Department of Defense  
Proposed Budget Reductions

Table 5

Prog ID	Sub-Org	Description of Reduction	Impact of Reduction	MOF	FY20			FY21			FY19 Restriction (Y/N)
					Pos (P)	Pos (T)	\$\$\$\$	Pos (P)	Pos (T)	\$\$\$\$	
DEF 110	AD	Delete 1 Temporary Proj Coordinator	None Project Ended	P		\$ (1)	\$ (115,738)		-1	\$ (115,738)	N

Department of Defense  
Proposed Budget Additions

Table 6

Prog ID	Sub-Org	Addition Type	Prog ID Priority	Dept-Wide Priority	Description of Addition	Justification	MOF	FY20			FY21			
								Pos (P)	Pos (T)	\$\$\$	Pos (P)	Pos (T)	\$\$\$	
DEF110	AB	OR	1	1	HIARNG - Utilities and facilities maintenance increase & update	This request is for anticipated increase in janitorial supplies and utilities rates and usage.								61,780
DEF110	AB	OR	1	1	HIARNG - Utilities and facilities maintenance increase & update	This request is for anticipated increase in janitorial supplies and utilities rates and usage.								185,338
DEF110	AC	OR	1	2	HIANG -increase utilities and facilities maintenance costs	Request to increase utilities and facilities maintenance costs due to rate and contract cost increases	A			48,371				48,371
DEF110	AC	OR	1	2	HIANG -increase utilities and facilities maintenance costs	Request to increase utilities and facilities maintenance costs due to rate and contract cost increases	P			144,174				144,174
DEF110	AA	OR	1	6	HIEMA - Emergency Management Agency Staffing - Administration Staff	This position will work with HI-EMA leadership in the following areas: managing personnel documentation; recruiting and long term promoting professional development opportunities for the team	A	1.00		26,478	1.00			52,956
DEF110	AA	OR	2	8	Chief Information Officer - upgrade aging Wi-Fi access points	Request funding to upgrade ageing Wi-Fi access points.	A			50,000				
DEF112	VA	OR	1	9	OVS - Hawaii State Veterans Cemetary-Excavator and Utility Tractor w/Attachments	Excavator is required for burial operations at HSVC.	A			125,000				
DEF110	AD	OR	1	10	HIEMA - Emergency Management Staff Funding	To convert emergency management expenses from MOF N & P funded to MOF A	A	8.50	22.00	2,003,603	8.50	22.00		2,003,603
DEF110	AD	OR	1	10	HIEMA - Emergency Management Staff Funding	To convert emergency management expenses from MOF N & P funded to MOF A	N	(7.50)	(11.00)	(2,022,049)	(7.50)	(11.00)		(2,022,049)
DEF110	AD	OR	1	10	HIEMA - Emergency Management Staff Funding	To convert emergency management expenses from MOF N & P funded to MOF A	P	(1.00)	(11.00)	(903,930)	(1.00)	(11.00)		(903,930)
DEF110	AD	OR	2	11	HIEMA - Emergency Management Agency Staffing - disaster positions	Hawaii had 2 presidentially declared disasters in FY 2018, April 2018 Severe Storms and May 2018 Kilauea East Rift Zone. Additional staffing is needed to process FEMA reimbursement requests of over \$51,000,000 in damages to the islands.	A		12.00	620,664		12.00		620,664
DEF110	AD	OR	3	12	HIEMA - Emergency Management Agency Staffing - Administration Staff	Project Ended Position Not Needed.	P		(1.00)	(115,738)		(1.00)		(115,738)
DEF114	YC	OR	1	13	Youth Challenge Academy-Increases in meal contract & school expenses	Price increase in meal contracts & school supplies & fees	A			77,000				77,000
DEF114	TC	OR	2	13	Youth Challenge Academy-Increases in meal contract & school expenses	Price increase in meal contracts & school supplies & fees	P			231,000				231,000
DEF110	AD	OR	4	21	HI-EMA Emergency Communications Infrastructure	Fixed and mobile hurricane resistant satellite and HF digital radio emergency communication equipment Equipment and network to be installed state-wide, all islands at State and County EOCs to provide backup stand-alone communications capable of withstanding major natural disasters	A			145,650				
DEF110	AD	OR	4	21	HI-EMA Emergency Communications Infrastructure	Fixed and mobile hurricane resistant satellite and HF digital radio emergency communication equipment Equipment and network to be installed state-wide, all islands at State and County EOCs to provide backup stand-alone communications capable of withstanding major natural disasters	N			428,100				

Department of Defense  
Proposed Budget Additions

Table 6

<u>Prog ID</u>	<u>Sub-Org</u>	<u>Addition Type</u>	<u>Prog ID Priority</u>	<u>Dept-Wide Priority</u>	<u>Description of Addition</u>	<u>Justification</u>	<u>MOF</u>	<u>Pos (P)</u>	<u>Pos (T)</u>	<u>\$\$\$</u>	<u>Pos (P)</u>	<u>Pos (T)</u>	<u>\$\$\$</u>
DEF110	AA		3	36	Major Disaster Fund	Hawaii had 2 presidentially declared disasters in FY 2018, April 2018 Severe Storms and May 2018 Kilauea East Rift Zone. This request is to provide funds for such Major Disaster in the State of Hawaii.	A			4,500,000			4,500,000

Department of Defense  
 FB 2017 - 2019 Restrictions

Table 7

<u>Fiscal Year</u>	<u>Prog ID</u>	<u>Sub-Org</u>	<u>MOF</u>	<u>Budgeted by Dept</u>	<u>Restriction</u>	<u>Difference Between Budgeted &amp; Restricted</u>	<u>Percent Difference</u>	<u>Impact</u>
2019	DEF 110	AA	A	\$ 10,109,407	\$ 422,062	\$ 9,687,345	4.17%	DOD temporarily deferred Vacant position and contract to cover the current restrictions.
2019	DEF 110	AB	A	\$ 854,508	\$ 35,675	\$ 818,833	4.17%	DOD temporarily deferred Vacant position and contract to cover the current restrictions.
2019	DEF 110	AC	A	\$ 862,027	\$ 35,989	\$ 826,038	4.17%	DOD temporarily deferred Vacant position and contract to cover the current restrictions.
2019	DEF 110	AD	A	\$ 5,376,214	\$ 224,454	\$ 5,151,760	4.17%	DOD temporarily deferred Vacant position and contract to cover the current restrictions.
2019	DEF 112	VA	A	\$ 2,811,072	\$ 110,704	\$ 2,700,368	3.94%	DOD temporarily deferred Vacant position and contract to cover the current restrictions.

Department of Defense  
Emergency Appropriation Requests

Table 8

<u>Prog ID</u>	<u>Description of Request</u>	<u>Explanation of Request</u>	<u>MOF</u>	<u>Pos (P)</u>	<u>Pos (T)</u>	<u>\$\$\$</u>
	NONE					



Department of Defense  
Expenditures Exceeding Appropriation Ceilings in FY18 and FY19

Prog ID	MOF	Date	Appropriation	Amount Exceeding Appropriation	Percent Exceeded	Reason for Exceeding Ceiling	Legal Authority	Recurring (Y/N)	GF Impact (Y/N)
						Disaster relief from the torrential rain and resultant flooding of April 2018 in the Kauai.			
G-18-322	A	7/1/2018	100,000,000			County of Kauai-flood Relief Apr 2018	Act 12, SLH2018		
		5/23/2018		\$25,000,000		Transfer to Kauai County			
		6/4/2018		\$2,000,000		Allotted to DOD			
		6/29/2018		\$1,550,000		Transfer to the AGR			
		6/28/2018		\$40,000,000		Transfer to DOT			
		10/22/2018		-\$25,000,000		DOT Returned funds to DOD			
		9/10/2018		\$5,000,000		Allotted to DOD			
		9/28/2018		\$2,935,044		Transferred to DLNR			
		11/20/2018		\$2,100,000		Transferred to DLNR			
		12/3/2018		\$220,000		Transferred to DLNR			
		12/3/2018		\$325,000		Transferred to DLNR			
		8/2/2018		\$125,000		Transferred to DOH			
			\$ 100,000,000	\$ 54,255,044					
				\$ 45,744,956.00		BALANCE			
G-18-323	A	7/1/2018	\$ 25,000,000			Areas other than Kauai-Flood 2018	Act 12, SLH2018		
G-18-323	A	5/23/2018		\$ 250,000		Transferred to the Dept of Agriculture			
G-18-323	A	5/23/2018		10,000,000		Transferred to C&C of Honolulu (East Honolulu Flood)			
G-18-323	A	10/30/2018		10,000,000		Transferred to County of Hawaii May 3 & Aug 7 East Rift Zone, lower Puna.			
G-18-323	A	9/24/2018		\$ 3,000,000		Transferred to UOH for study			
			\$ 25,000,000	\$ 23,250,000					
				\$ 1,750,000		BALANCE			

Department of Defense  
Intradepartmental Transfers in FY18 and FY19

Table 10

<u>Actual or Anticipated Date of Transfer</u>	<u>MOF</u>	<u>Pos (P)</u>	<u>Pos (T)</u>	<u>\$\$\$</u>	<u>From Prog ID</u>	<u>Percent of Program ID Appropriation Transferred From</u>	<u>To Prog ID</u>	<u>Percent of Receiving Program ID Appropriation</u>	<u>Reason for Transfer</u>	<u>Recurring (Y/N)</u>
						NONE				

Department of Defense  
Vacancy Report as of November 30, 2018

Prog ID	Sub-Org	Date of Vacancy	Expected Fill Date	Position Number	Position Title	Exempt (Y/N)	SR Level	BU Code	Perm Temp (P/T)	FTE	MOF	Budgeted Amount	Actual Salary Last Paid	Authority to Hire (Y/N)	Occupied by 89 Day Hire (Y/N)	# of 89 Hire Appts	Describe if Filled by other Means	Priority # to Retain
DEF110	AA			00030003	Power Mower Operator I	N	BC03	01	T	0.50	A / P	\$1,636.00	\$0.00		N		Temp Assignments only	
DEF110	AA	4/16/1990		00017585	Tractor Operator	N	BC04	01	T	0.50	A / P	\$1,702.00	\$0.00		N		Temp Assignments only	
DEF110	AA	2/28/2012		00119391	MCA Clerk	Y	SRNA	03	T	1.00	N		\$2,188.00		N			
DEF110	AA	1/12/2013		00110149	Anti-Terrorism Planner II	Y	SRNA	13	T	1.00	N	\$8,732.00	\$4,623.00		Y	9	Filled by 89day / hrly Hire	
DEF110	AA	5/2/2014		00121265	Program Specialist IV	N	SRNA	13	T	1.00	P	\$4,160.00	\$3,873.00		N			
DEF110	AA	7/1/2015		00117354	Engineer V	N	SR26	13	P	1.00	A	\$4,810.00	\$2,769.00		N			
DEF110	AA	2/23/2016		00110630	Anti-Terrorism Planner I	Y	SRNA	13	T	1.00	A	\$4,490.00	\$4,062.00		N			
DEF110	AA	7/1/2016		00122181	Homeland Security Planner	Y	SRNA	00	P	1.00	N	\$6,666.00	\$0.00		Y	1	Filled by 89day / hrly Hire	
DEF110	AA	10/18/2016		00044478	General Laborer III	N	WS03	01	P	1.00	A	\$3,270.00	\$3,270.00		N			
DEF110	AA	11/16/2016		00009549	Office Assistant IV	N	SR10	03	P	1.00	A	\$3,450.00	\$3,422.00		Y	2	Filled by 89day / hrly Hire	
DEF110	AA	12/20/2016		00122182	Investigator V	N	SRNA	00	P	1.00	N	\$6,666.00	\$0.00		Y	7	Filled by 89day / hrly Hire	
DEF110	AA	12/29/2016		00121265	Program Specislist IV	N	SR22	13	T	1.00	P		\$0.00		N			
DEF110	AA	6/1/2017		00005672	Purchasing Technician I	N	SR11	03	P	1.00	A		\$2,748.00		N		Pending Clearance	
DEF110	AA	12/31/2017		00027311	Information Specialist III	N	SR20	13	P	1.00	A		\$5,911.00		N			
DEF110	AA	12/31/2017		00120585	Engineer VI	N	SR28	23	P	1.00	A		\$8,414.00		N			
DEF110	AA	1/16/2018		00100543	Chief Engineering Officer	Y	SRNA	00	P	1.00	A		\$11,259.17		N			
DEF110	AA	3/29/2018		00122634	Air Conditioning Mechanic I	N	BC10	01	P	1.00	A		\$0.00		N			
DEF110	AA	4/15/2018	11/16/2018	00121001	Management Analsyt V	N	SR26	73	P	1.00	A		\$6,148.00		N		Positions Filled	
DEF110	AA	6/9/2018		00005666	Office Assistant III	N	SR08	03	P	1.00	A		\$2,434.00		N			
DEF110	AA	7/1/2018		00048750	Accountant III	N	SR20	13	P	1.00	A / P		\$4,316.00		N			
DEF110	AA	7/16/2018		00048748	Account Clerk II	N	SR08	03	P	1.00	A / P		\$2,909.00		Y	1	Filled by 89day / hrly Hire	
DEF110	AA	7/21/2018		00009552	Building Maintenance Worker I	N	BC09	01	P	1.00	A		\$4,488.00		N			
DEF110	AA	8/1/2018		00118135	General Laborer II	N	BC03	01	P	1.00	A		\$3,442.00		N			
DEF110	AA	10/1/2018		00012838	Departmental Human Resources Officer I	N	EM03	35	P	1.00	A		\$9,377.00		N			
DEF110	AA	10/1/2018		00120608	Program Specialist V	N	SR24	13	P	1.00	A		\$7,354.00		N			
DEF110	AB	8/16/2004		00117054	Air Conditioning Mechanic I	N	BC10	01	T	1.00	P	\$4,427.00	\$0.00		N			
DEF110	AB	12/15/2006		00112985	Engineering Technician VII	N	SR19	03	P	1.00	P	\$3,450.00	\$0.00		N			
DEF110	AB	10/1/2010		00117931	ITAM Coordinator	Y	SRNA	13	T	1.00	P	\$4,618.00	\$4,618.08		Y	1	Filled by 89day / hrly Hire	
DEF110	AB	4/30/2011		00116403	Environmental Program Manager	Y	SRNA	13	T	1.00	P	\$5,974.00	\$4,276.00		N		Position Awaiting Civil Service Conversions	
DEF110	AB	5/23/2015		00119108	Building Const Inspector II	N	SR19	03	P	1.00	P	\$3,450.00	\$3,422.00		N			
DEF110	AB	3/11/2016		00110724	Administrative Officer V	N	SR24	13	P	1.00	P	\$4,611.00	\$4,000.00		N			

Department of Defense  
Vacancy Report as of November 30, 2018

Table 11

Prog ID	Sub-Org	Date of Vacancy	Expected Fill Date	Position Number	Position Title	Exempt (Y/N)	SR Level	BU Code	Perm Temp (P/T)	FTE	MOF	Budgeted Amount	Actual Salary Last Paid	Authority to Hire (Y/N)	Occupied by 89 Day Hire (Y/N)	# of 89 Hire Appts	Describe if Filled by other Means	Priority # to Retain
DEF110	AB	5/12/2016		00117933	Data Administrator (FMO)	Y	SRNA	03	T	1.00	P	\$3,328.00	\$3,328.00		N		Position Awaiting Civil Service Conversions	
DEF110	AB	6/1/2016		00116402	Environmental Health Specialist IV	N	SR24	13	P	1.00	P	\$5,705.00	\$6,521.00		N			
DEF110	AB	7/1/2016		00005676	Office Assistant III	N	SR08	03	P	1.00	A	\$2,321.00	\$3,165.00		N			
DEF110	AB	9/10/2016		00116846	Environmental Health Specialist IV	N	SR22	13	P	1.00	P	\$5,267.00	\$5,176.00		N			
DEF110	AB	12/31/2016		00000270	General Laborer I	N	BC02	01	P	0.50	A / P	\$3,180.00	\$1,590.00		Y	2	Filled by 89day / hrly Hire	
DEF110	AB	1/14/2017		00120449	Program Specialist IV (AES)	N	SR22	13	P	1.00	P	\$3,669.00	\$5,693.00		N			
DEF110	AB	5/13/2017		00110436	Facilities Planner Assistant	Y	SRNA	03	T	1.00	N		\$2,601.00		Y	6	Filled by 89day / hrly Hire	
DEF110	AB	8/1/2017		00117976	Environmental Health Specialist V	N	SR24	13	P	1.00	P		\$5,254.00		N			
DEF110	AB	9/2/2017		00117930	Environmental Health Specialist IV	N	SR22	13	P	1.00	P		\$5,463.00		N			
DEF110	AB	10/23/2017		00119109	Contracts Assistant I	N	SR13	03	P	1.00	A		\$2,705.00		Y	2	Filled by 89day / hrly Hire	
DEF110	AB	12/1/2017		00120527	Repairs & Maintenance Assistant	N	SR18	03	P	1.00	P		\$3,604.00		N			
DEF110	AB	3/4/2018		00116846	Environmental Health Specialist IV	N	SR22	13	P	1.00	P		\$4,316.00		N			
DEF110	AB	4/7/2018		00120847	Design & Project Assistant	Y	SRNA	13	T	1.00	P		\$3,910.00		N			
DEF110	AB	5/1/2018		00121202	DLP Technician	Y	SRNA	03	T	1.00	P		\$3,498.00		N			
DEF110	AB	6/21/2018		00122693	Engineer IV	N	SR24	13	T	1.00	N		\$0.00		N			
DEF110	AB	7/2/2018		00117983	Program Specialist IV	N	SR22	13	P	1.00	P		\$0.00		N			
DEF110	AB	10/1/2018		00120544	Install Status Report Technician Infrastructure	Y	SRNA	03	T	1.00	P		\$4,475.00		N			
DEF110	AB	12/31/2018		00117333	Environmental Health Specialist IV	N	SR22	13	P	1.00	P		\$5,167.00		N			
DEF110	AC	9/29/2012		00119471	Security Admin Specialist	Y	SRNA	00	P	1.00	P	\$4,276.00	\$4,560.00		N		To be abolished, per ACT49, SLH 2017	
DEF110	AC	12/1/2016		00040440	Building Maintenance Helper	N	BC05	01	P	1.00	A / P	\$3,538.00	\$3,538.00		N			
DEF110	AC	1/8/2018		00021624	Building Maintenance Worker I	N	BC09	01	P	1.00	A / P		\$4,349.00		N			
DEF110	AC	4/16/2018		00050391	General Laborer I	N	BC02	01	P	1.00	P		\$3,244.00		Y	1	Filled by 89day / hrly Hire	
DEF110	AC	5/1/2018		00117484	Account Clerk III	N	SR11	03	P	1.00	A / P		\$3,077.00		N			
DEF110	AC	8/16/2018		00120289	STARBASE Director	Y	SRNA	13	T	1.00	P		\$5,312.00		N			
DEF110	AC	12/31/2018		00036613	Private Secretary I	N	SR20	63	P	1.00	A		\$5,267.00		N			
DEF110	AD	2/13/2006		00117813	DEPA Accountant	Y	SRNA	13	T	1.00	A / N	\$4,002.00	\$0.00		Y	6	Filled by 89day / hrly Hire	
DEF110	AD	7/1/2006		00117371	Oct 04 Flood Bldg Inspector	Y	SRNA	03	T	1.00	A		\$0.00		N			
DEF110	AD	12/16/2006		00100934	Engineer IV	N	SR24	13	P	1.00	A / N	\$4,502.00	\$4,446.36		N			
DEF110	AD	9/3/2008		00119135	Building Const Inspector II	N	SR19	03	T	1.00	A	\$3,450.00	\$0.00		N			
DEF110	AD	3/7/2015		00118318	Oct06KiholoBayEQProjectLeader	Y	SRNA	23	T	1.00	A / P	\$5,203.00	\$5,002.00		N			

Department of Defense  
Vacancy Report as of November 30, 2018

Prog ID	Sub-Org	Date of Vacancy	Expected Fill Date	Position Number	Position Title	Exempt (Y/N)	SR Level	BU Code	Perm Temp (P/T)	FTE	MOF	Budgeted Amount	Actual Salary Last Paid	Authority to Hire (Y/N)	Occupied by 89 Day Hire (Y/N)	# of 89 Hire Appts	Describe if Filled by other Means	Priority # to Retain
DEF110	AD	4/14/2015		00121701	Disaster Assistance Accountant	Y	SRNA	13	T	1.00	A	\$3,651.00	\$0.00		N			
DEF110	AD	1/16/2016		00031187	Civil Defense Planner	N	SR24	13	P	1.00	A / N	\$4,684.00	\$4,276.00		Y	1	Filled by 89day / hrly Hire	
DEF110	AD	4/1/2016		00118526	Oct06KiholoBayEQBldgInspector	Y	SRNA	03	T	1.00	A	\$3,695.00	\$3,553.00		N			
DEF110	AD	5/11/2016		00118323	Oct06KiholoBayEQClkTypist	Y	SRNA	03	T	1.00	A / P	\$2,315.00	\$2,225.00		N			
DEF110	AD	9/16/2016		00036408	Radio Technician I	N	SR19	03	P	1.00	A / N	\$4,718.00	\$4,161.00		Y	1	Filled by 89day / hrly Hire	
DEF110	AD	12/1/2016		00122282	Disaster Asst Mitigation Planner	Y	SRNA	13	T	1.00	A	\$4,328.00	\$0.00		Y	7	Filled by 89day / hrly Hire	
DEF110	AD	1/1/2017		00116833	Office Assistant III	Y	SRNA	03	T	1.00	P	\$2,066.00	\$2,221.00		Y	3	Filled by 89day / hrly Hire	
DEF110	AD	1/1/2017		00118528	Disaster Recovery Clerk Typist	Y	SRNA	03	T	1.00	P		\$0.00		N			
DEF110	AD	2/1/2017		00122310	Program Specialist (Siren Modernization)	Y	SRNA	00	T	1.00	A		\$0.00		Y	2	Filled by 89day / hrly Hire	
DEF110	AD	4/6/2017		00122369	Disaster Assistance Leader (Pu'u O'o Lava Flow)	Y	SRNA	00	T	1.00	A		\$0.00		N			
DEF110	AD	4/6/2017		00122370	Disaster Assistant Building Inspector (Pu'u O'o Lava Flow)	Y	SRNA	00	T	1.00	A		\$0.00		N			
DEF110	AD	4/29/2017		00119394	Office Assistant III	N	SR08	03	T	1.00	A		\$2,261.00		Y	2	Filled by 89day / hrly Hire	
DEF110	AD	9/1/2017		00117800	EOC Operations & Threat Specialist	Y	SRNA	13	T	1.00	A / P		\$4,061.00		N			
DEF110	AD	12/18/2017		00117815	Office Assistant III	N	SR08	03	T	1.00	A / P		\$2,225.00		Y	1	Filled by 89day / hrly Hire	
DEF110	AD	2/6/2018		00117804	EOC Warning Officer	Y	SRNA	03	T	1.00	A / P		\$2,938.00		N			
DEF110	AD	2/16/2018		00117817	Information Specialist III	N	SR18	13	T	1.00	A		\$3,497.00		Y	1	Filled by 89day / hrly Hire	
DEF110	AD	8/28/2018		00122757	Program Specialist IV	N	SR22	13	P	1.00	A / P		\$0.00		N			
DEF110	AD	9/1/2018		00118055	Mar 06 Flood Accountant	Y	SRNA	13	T	1.00	A		\$3,652.00		N			
DEF110	AD	9/15/2018		00121698	Disaster Assistant Accountant	Y	SRNA	13	T	1.00	A		\$3,750.00		N			
DEF110	AD	9/29/2018		00102887	Civil Defense Planner	N	SR24	13	P	1.00	A / P		\$5,811.00		N			
DEF112	VA	11/1/2016		00120276	Veterans Services Counselor II	N	SR18	13	P	1.00	A	\$3,715.00	\$3,497.00		N			
DEF112	VA	11/2/2017		00120277	Veterans Services Counselor III	N	SR20	13	P	1.00	A	\$3,715.00	\$3,839.00		N			
DEF112	VA	4/1/2018		00045254	Cemetery Operatons Manager	N	SR24	13	P	1.00	A	\$5,357.00	\$4,112.00		N		Pending Clearance	
DEF112	VA	11/20/2018		00044564	Secretary I	N	SR12	03	P	1.00	A	\$3,477.00	\$2,738.00		N			
DEF112	VA	12/31/2018		00040451	Office Assistant IV	N	SR10	03	P	1.00	A	\$2,748.00	\$2,909.00		N			
DEF114	YC			00120140	Instructor - Kulani	Y	SRNA	00	T	1.00	A / P	\$3,072.00	\$0.00		N		Awaiting Federal Match	
DEF114	YC	10/14/2010		00120183	Cadre - Kulani	Y	SRNA	00	T	1.00	A / P	\$2,756.00	\$0.00		N			
DEF114	YC	5/22/2015		00121753	Counselor I	Y	SRNA	00	T	1.00	A / P	\$2,912.00	\$0.00		N			

Department of Defense  
Vacancy Report as of November 30, 2018

Prog ID	Sub-Org	Date of Vacancy	Expected Fill Date	Position Number	Position Title	Exempt (Y/N)	SR Level	BU Code	Perm Temp (P/T)	FTE	MOF	Budgeted Amount	Actual Salary Last Paid	Authority to Hire (Y/N)	Occupied by 89 Day Hire (Y/N)	# of 89 Hire Appts	Describe if Filled by other Means	Priority # to Retain
DEF114	YC	7/1/2015		00120176	Cadre - Kulani	Y	SRNA	00	T	1.00	A / P	\$2,949.00	\$2,837.00		N		Awaiting Federal Match	
DEF114	YC	7/1/2015		00120177	Cadre - Kulani	Y	SRNA	00	T	1.00	A / P	\$2,840.00	\$2,837.00		N		Awaiting Federal Match	
DEF114	YC	2/23/2016		00120146	Case Manager	Y	SRNA	00	T	1.00	A / P	\$2,949.00	\$2,837.00		N			
DEF114	YC	7/1/2016		00120155	Admin Asst -Kulani	Y	SRNA	00	T	1.00	A / P	\$3,069.00	\$2,728.00		N		Awaiting Federal Match	
DEF114	YC	7/1/2016		00120168	Cadre - Kulani	Y	SRNA	00	T	1.00	A / P	\$2,949.00	\$2,837.00		N		Awaiting Federal Match	
DEF114	YC	7/1/2016		00120169	Cadre - Kulani	Y	SRNA	00	T	1.00	A / P	\$2,951.00	\$2,837.00		N		Awaiting Federal Match	
DEF114	YC	9/2/2016		00120174	Cadre - Kulani	Y	SRNA	00	T	1.00	A / P	\$2,840.00	\$2,837.00		N		Awaiting Federal Match	
DEF114	YC	2/21/2017		00119129	Cadre	Y	SRNA	00	T	1.00	A / P	\$3,289.00	\$2,934.00		N			
DEF114	YC	4/28/2017		00120179	Cadre	Y	SRNA	00	T	1.00	A / P		\$2,934.00		N			
DEF114	YC	5/6/2017		00120182	Cadre	Y	SRNA	00	T	1.00	A / P		\$2,837.00		N			
DEF114	YC	7/11/2017		00119130	Nurse	Y	SRNA	00	T	1.00	A / P		\$3,114.00		N			
DEF114	YC	7/15/2017		00111777	Cadre	Y	SRNA	00	T	1.00	A / P		\$2,934.00		N			
DEF114	YC	7/17/2017		00120150	KOA Program Coordinator	Y	SRNA	00	T	1.00	A / P		\$4,350.00		N			
DEF114	YC	2/21/2018		00120162	Cadre	Y	SRNA	00	T	1.00	A / P		\$3,080.00		N			
DEF114	YC	4/16/2018		00120134	Program Coordinator - Kulani	Y	SRNA	00	T	1.00	A / P		\$3,375.00		N			
DEF114	YC	5/12/2018		00102871	Cadre	Y	SRNA	00	T	1.00	A / P		\$3,080.00		N			
DEF114	YC	6/2/2018		00120139	Instructor - Kulani	Y	SRNA	00	T	1.00	A / P		\$3,265.00		N			
DEF114	YC	6/15/2018		00111779	Cadre	Y	SRNA	00	T	1.00	A / P		\$2,934.00		N			
DEF114	YC	8/8/2018		00120136	Instructor - Kulani	Y	SRNA	00	T	1.00	A / P		\$3,330.00		N			
DEF114	YC	9/28/2018		00102876	Cadre	Y	SRNA	00	T	1.00	A / P		\$2,727.00		N			
DEF114	YC	10/1/2018		00102838	Director, YCA	Y	SRNA	00	T	1.00	A / P		\$7,000.00		N			
DEF114	YC	10/1/2018		00102875	Shift Leader	Y	SRNA	00	T	1.00	A / P		\$3,400.00		N			
DEF114	YC	10/10/2018		00102870	Assistant Shift Leader	Y	SRNA	00	T	1.00	A / P		\$3,210.00		N			
DEF114	YC	10/17/2018		00120154	Recruiting Assistant	Y	SRNA	00	T	1.00	A / P		\$2,950.00		N			
DEF114	YC	11/3/2018		00120161	Shift Leader - Kulani	Y	SRNA	00	T	1.00	A / P		\$3,040.00		N			
DEF114	YC	11/5/2018		00102863	Cadre	Y	SRNA	00	T	1.00	A / P		\$2,934.00		N			

Positions Established by Acts other than the State Budget as of November 30, 2018

<u>Prog ID</u>	<u>Sub-Org</u>	<u>Date Established</u>	<u>Legal Authority</u>	<u>Position Number</u>	<u>Position Title</u>	<u>Exempt (Y/N)</u>	<u>SR Level</u>	<u>BU Code</u>	<u>T/P</u>	<u>MOF</u>	<u>FTE</u>	<u>Annual Salary</u>	<u>Filled (Y/N)</u>	<u>Occupied by 89 Day Hire (Y/N)</u>
----------------	----------------	-------------------------	------------------------	------------------------	-----------------------	---------------------	-----------------	----------------	------------	------------	------------	----------------------	---------------------	--------------------------------------

NONE

Department of Defense  
Overtime Expenditure Summary

Table 13

Prog ID	Sub-Org	Program Title	MOF	FY18 (actual)			FY19 (estimated)			FY20 (budgeted)			FY21 (budgeted)		
				Base Salary \$\$\$\$	Overtime \$\$\$\$	Overtime Percent	Base Salary \$\$\$\$	Overtime \$\$\$\$	Overtime Percent	Base Salary \$\$\$\$	Overtime -\$-\$-\$	Overtime Percent	Base Salary \$\$\$\$	Overtime -\$-\$-\$	Overtime Percent
DEF 110	AA	DEPARTMENTAL ADMINISTRATION	A	\$ 4,807,120	\$ 48,477	1.0%	\$ 5,715,781	\$ 48,477	0.8%	\$ 6,055,992	\$ -	0.0%	\$ 6,107,990	\$ -	0.0%
DEF 110	AA	DEPARTMENTAL ADMINISTRATION	N	\$ 259,345	\$ -	0.0%	\$ 336,369	\$ -	0.0%	\$ 280,697	\$ -	0.0%	\$ 280,697	\$ -	0.0%
DEF 110	AA	DEPARTMENTAL ADMINISTRATION	P				\$ 805,791		0.0%	\$ 878,011		0.0%	\$ 904,489		0.0%
DEF 110	AB	HAWAII ARMY NATIONAL GUARD	A	\$ 451,468	\$ 56	0.0%	\$ 461,100	\$ 56	0.0%	\$ 474,541	\$ -	0.0%	\$ 478,308	\$ -	0.0%
DEF 110	AB	HAWAII ARMY NATIONAL GUARD	P	\$ 4,059,207	\$ 21,615	0.5%	\$ 4,173,114	\$ 21,615	0.5%	\$ 4,033,031	\$ -	0.0%	\$ 4,062,526	\$ -	0.0%
DEF 110	AC	HAWAII AIR NATIONAL GUARD	A	\$ 341,879	\$ -	0.0%	\$ 458,450	\$ -	0.0%	\$ 493,979	\$ -	0.0%	\$ 499,205	\$ -	0.0%
DEF 110	AC	HAWAII AIR NATIONAL GUARD	P	\$ 1,409,513	\$ -	0.0%	\$ 1,151,067	\$ -	0.0%	\$ 1,223,313	\$ -	0.0%	\$ 1,239,846	\$ -	0.0%
DEF 110	AD	HAWAII EMERGENCY MANAGEMENT AGENCY	A	\$ 2,127,007	\$ 40,453	1.9%	\$ 3,017,259	\$ 40,453	1.3%	\$ 5,427,111	\$ -	0.0%	\$ 5,446,770	\$ -	0.0%
DEF 110	AD	HAWAII EMERGENCY MANAGEMENT AGENCY	N	\$ 1,160,532	\$ 23,112	2.0%	\$ 972,337	\$ 23,112	2.4%			#DIV/0!			#DIV/0!
DEF 110	AD	HAWAII EMERGENCY MANAGEMENT AGENCY	P	\$ 22,483	\$ -	0.0%	\$ 672,232	\$ -	0.0%			#DIV/0!			#DIV/0!
DEF 112	VA	SERVICES TO VETERANS	A	\$ 1,191,127	\$ 22,488	1.9%	\$ 1,391,790	\$ 22,488	1.6%	\$ 1,435,912	\$ -	0.0%	\$ 1,447,654	\$ -	0.0%
DEF 114	YC	HAWAII NATIONAL GUARD YOUTH CHALLENGE ACADEMY	A	\$ 968,493	\$ 28,054	2.9%	\$ 993,936	\$ 28,054	2.8%	\$ 1,004,839	\$ -	0.0%	\$ 1,004,839	\$ -	0.0%
DEF 114	YC	HAWAII NATIONAL GUARD YOUTH CHALLENGE ACADEMY	P	\$ 2,287,414	\$ -	0.0%	\$ 2,981,808	\$ -	0.0%	\$ 2,987,727	\$ -	0.0%	\$ 2,990,727	\$ -	0.0%



Department of Defenses  
Active Contracts as of December 1, 2018

Table 14

Prog ID	MOF	Amount	Frequency (M/A/O)	Max Value	Outstanding Balance	Term of Contract			Entity	Contract Description	Explanation of How Contract is Monitored	POS Y/N	Category E/L/P/C/G/S
						Date Executed	From	To					
DEF114	P	\$ 93,527.05	M	\$ 101,002.71	\$ 6,766.88	4/1/2014	5/1/2014	6/30/2019	EOH Enterprises, LLC dba Envision Networked Solutions	VOIP Phone Services for YCA locations on Oahu & Hawaii, Contract #62770, CA-1408	Contract is monitored by the Division's Project Manager.	Y	S
DEF114	P	\$ 1,526,122.16	M	\$ 1,914,058.00	\$ 343,207.28	10/15/2014	11/1/2014	6/30/2019	Dongyuan Food Service, LLC	Furnishing Prepared Meals for the Hawaii National Guard YCA, Hilo, Contract 63417, CA-1413	Contract is monitored by the Division's Project Manager.	N	G
DEF110	P	\$ 737,432.23	M	\$ 848,046.60	\$ 83,499.50	9/1/2014	10/24/2014	3/13/2019	EMPICO dba Jani- King HI	Custodial Services for Armed Forces Readiness Center at Keaukaha Military Reservation, Contract #63395, CA-1417	Contract is monitored by the Division's Project Manager.	Y	S
DEF114	P	\$ 2,108,216.07	M	\$ 2,659,968.00	\$ 475,977.50	7/1/2015	7/1/2015	6/30/2019	Nippon Food Takeout & Catering, Inc.	Furnish Prepared Meals for HYCA, Kalaeloa, Contract #64017, CA-1513	Contract is monitored by the Division's Project Manager.	N	G
DEF110	P	\$ 188,825.41	M	\$ 503,677.00	\$ 174,659.29	10/1/2016	10/1/2016	9/30/2019	Honolulu Disposal Service, Inc.	ARNG & HYCA Refuse Collection & Disposal for Various Locations on Oahu, Contract #65230, CA-1607	Contract is monitored by the Division's Project Manager.	Y	S
DEF110	P	\$ 384,831.67	M	\$ 668,856.00	\$ 229,748.00	1/1/2017	1/11/2017	9/30/2019	Island Wide A/C Svc, LLC	A/C System Preventative Maintenance Services for various Facilities on Oahu, Contract #65392, CA-1608	Contract is monitored by the DOD Engineering Office/	Y	S
DEF110	P	\$ 219,960.14	M	\$ 320,193.00	\$ 99,774.18	10/1/2016	10/1/2016	9/30/2019	Honolulu Disposal Service, Inc.	ANG Refuse Collection & Disposal for JBPHH & Kalaeloa, Contract #65231, CA-1609	Contract is monitored by the Division's Project Manager.	Y	S
DEF112	A	\$ 124,800.00	O-As needed	\$ 250,800.00	\$ 126,000.00	7/1/2017	9/1/2017	6/30/2019	Polyguard, LLC dba Pollyguard & Co.	Polypropylene Burial Vaults for HSVC, Contract #65894, CA-1702	Contract is monitored by the Division's Project Manager.	N	G
DEF112		\$ 17,352.00	M	\$ 354,000.00	\$ 336,648.00	6/15/2018	9/4/2018	3/3/2019	Loves landscaping	Tree Pruning and Removal at HSVC, Phase 2, Contract #66914, CA-1804	Contract is monitored by the DOD Engineering Office/	Y	S
DEF110		\$ -	O-When received	\$ 338,790.00	\$ 338,790.00	8/16/2018	9/14/2018	3/31/2019	Servco Auto Waipahu	Bomb Squad Vehicles, Contract #67163, CA-1810	Contract is monitored by the Division's Project Manager.	N	G
DEF110		\$ -	M	\$ 274,093.00	\$ 274,093.00	9/20/2018	Not yet issued		JB Construction	High Expansion Foam (HEF) System Services for HIANG, JBPHH, Contract#67315, CA-1812	Contract is monitored by the Division's Project Manager.	Y	S
DEF110		\$ 50,942.37	O	\$ 249,454.00	\$ 198,511.34	8/14/2018	9/14/2018	9/13/2019	Capstar Radio Operating Co.	Statewide Emergency Preparedness Media Plan, Contract #67150, CA- 1816	Contract is monitored by the Division's Project Manager.	Y	S
DEF110		\$ -	O-When received	\$ 751,124.00	\$ 751,124.00	7/1/2018	6/26/2018	1/31/2019	Romotec, Inc.	Bomb Squad Robots, Contract #67265, CA-1819	Contract is monitored by the Division's Project Manager.	N	G
DEF110		\$ 14,050.00	O-As needed	\$ 56,200.00	\$ 42,150.00	8/31/2018	10/1/2018	9/30/2019	EA Engineering, Science & Technology, Inc.	Storm Water Management & Sampling Services, Contract #67185, CA-1820	Contract is monitored by the Division's Project Manager.	Y	S
DEF110	P	\$ 91,952.56	M	\$ 2,681,044.00	\$ 2,589,091.19	10/1/2018	10/1/2018	9/30/2019	Alii Security Systems, Inc.	Security Guard Services for Oahu & Hawaii, Contract #67275, CA-1823	Contract is monitored by the Division's Project Manager.	Y	S

Department of Defense  
Capital Improvements Program (CIP) Requests

Table 15

<u>Prog ID</u>	<u>Prog ID</u> <u>Priority</u>	<u>Dept- Wide</u> <u>Priority</u>	<u>Senate</u> <u>District</u>	<u>Rep.</u> <u>District</u>	<u>Project Title</u>	<u>MOF</u>	<u>FY20 \$\$\$</u>	<u>FY21 \$\$\$</u>
DEF-112	1	1	16	33	VA LONG-TERM CARE FACILITY, OAHU	C	31,783,000	
DEF-112	1	1	16	33	VA LONG-TERM CARE FACILITY, OAHU	P	3,717,000	
DEF-110	1	2	9	19	FORT RUGER B306 AND B306A, HURRICANE HARDENING, OAHU	C	665,000	1,240,000
DEF-110	2	3	0	0	DISASTER WARNING AND COMMUNICATIONS DEVICES, STATEWIDE	C	2,500,000	
DEF-110	3	4	0	0	RETROFIT PUBLIC BUILDINGS WITH HURRICANE PROTECTIVE MEASURES, STATEWIDE	C		3,000,000
DEF-110	4	5	20	43	UPGRADES AND IMPROVEMENTS TO NATIONAL GUARD READINESS CENTERS AND FACILITIES, STATEWIDE	C		2,096,000
DEF-110	4	5	20	43	UPGRADES AND IMPROVEMENTS TO NATIONAL GUARD READINESS CENTERS AND FACILITIES, STATEWIDE	P		7,456,000
DEF-110	5	6	9	19	BIRKHIMER EMERGENCY OPERATION CENTER SECURITY AND ACCESS IMPROVEMENTS, OAHU	C	313,000	127,000
DEF-112	2	7	24	49	HAWAII STATE VETERANS CEMETERY UPGRADES AND IMPROVEMENTS, OAHU	C	1,000,000	
DEF-112	2	7	24	49	HAWAII STATE VETERANS CEMETERY UPGRADES AND IMPROVEMENTS, OAHU	P	4,546,000	

Department of Defense  
CIP Lapses

Table 16

<u>Prog ID</u>	<u>Act/Year of Appropriation</u>	<u>Project Title</u>	<u>MOF</u>	<u>Lapse Amount</u> <u>\$\$\$\$</u>	<u>Reason</u>
----------------	----------------------------------	----------------------	------------	--	---------------





DAVID Y. IGE  
GOVERNOR

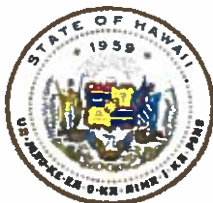

ARTHUR J. LOGAN  
MAJOR GENERAL  
ADJUTANT GENERAL

KENNETH S. HARA  
BRIGADIER GENERAL  
DEPUTY ADJUTANT GENERAL

STATE OF HAWAII  
**DEPARTMENT OF DEFENSE**  
OFFICE OF THE ADJUTANT GENERAL  
3949 DIAMOND HEAD ROAD  
HONOLULU, HAWAII 96816-4495

August 22, 2018

TO: The Honorable Laurel A. Johnston, Director  
Department of Budget and Finance

THROUGH: Mr. Neal Miyahira, Administrator  
Budget, Program Planning and Management Division

FROM: *fw* Major General Arthur J. Logan, Adjutant General  
Department of Defense *afara*

SUBJECT: ANNUAL REVIEW AND UPDATE OF DEPARTMENTAL ORGANIZATION  
AND POSITION ORGANIZATION CHARTS AND FUNCTIONAL  
STATEMENTS, DEPARTMENT OF DEFENSE

In accordance with Administrative Directive 17-01 dated November 28, 2017, and Finance Memorandum 18-15 dated July 31, 2018, we respectfully submit the subject charts and statements as of June 30, 2018 as required.

We appreciate your support and the assistance from your staff in providing positive guidance and constructive feedback as we update our organizational charts and functional statements.

Please contact Mr. Rusty Spray, Administrative Services Officer, Administrative Services Office at 369-3458 or [rusty.spray@hawaii.gov](mailto:rusty.spray@hawaii.gov) if there are any questions or if additional information is required..

Attachments:

DOD Present Organization and Position Organization Charts – electronic copy  
DOD Present Functional Statements – electronic copy

Copies and attachments to:

Office of the Governor  
Office of the Lieutenant Governor  
Department of Human Resources Development  
Hawaii Government Employees Association  
United Public Workers

STATE OF HAWAII  
 DEPARTMENT OF DEFENSE  
 OFFICE OF THE ADJUTANT GENERAL  
 CHART 1

**ORGANIZATION CHART**

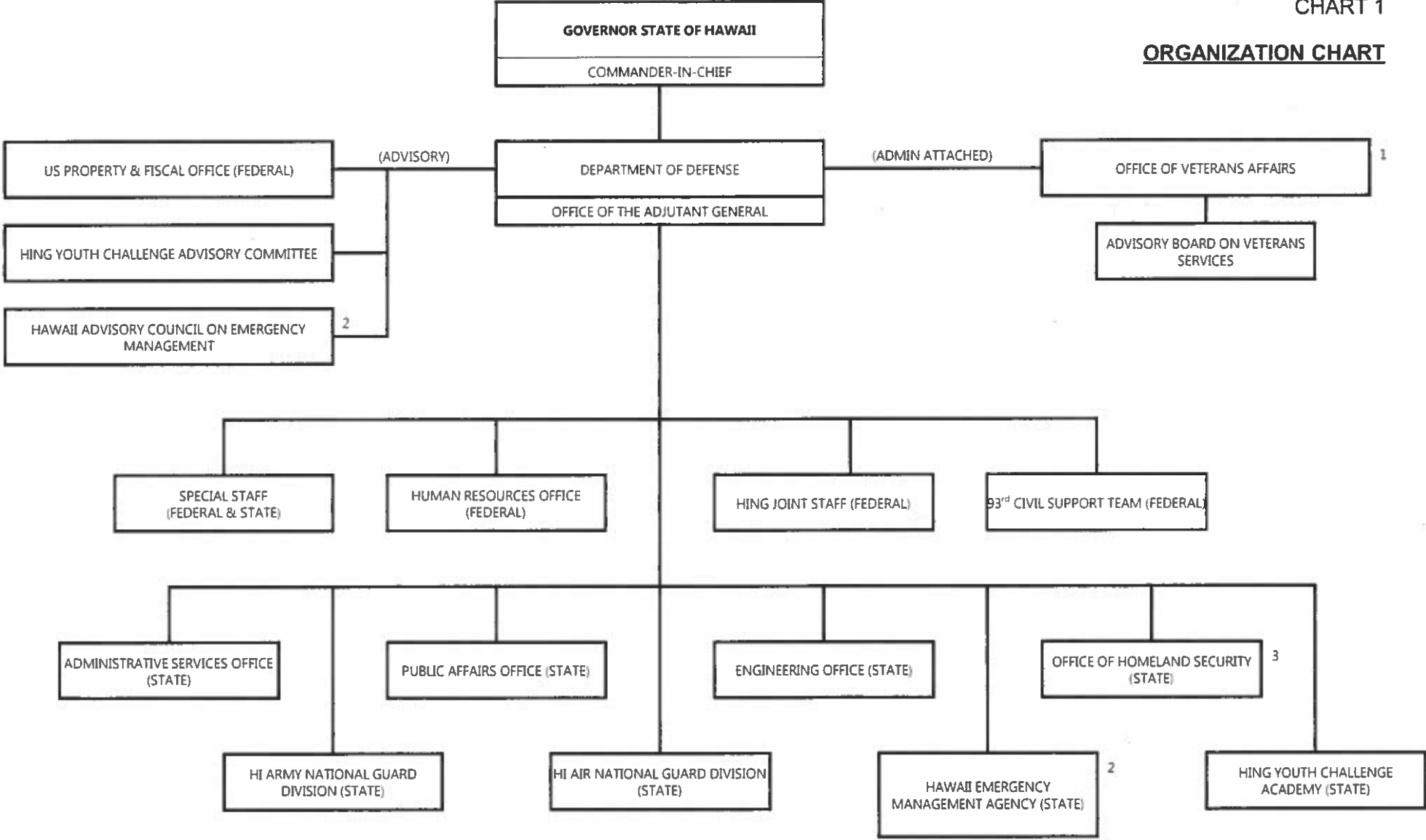

1 – Administratively attached per Act 115, SLH 1988  
 2 – Renamed per Act 111, SLH 2014  
 3 – Created per Act 175, SLH 2013

STATE OF HAWAII  
 DEPARTMENT OF DEFENSE  
 OFFICE OF THE ADJUTANT GENERAL  
 CHART 2

**POSITION ORGANIZATION CHART**

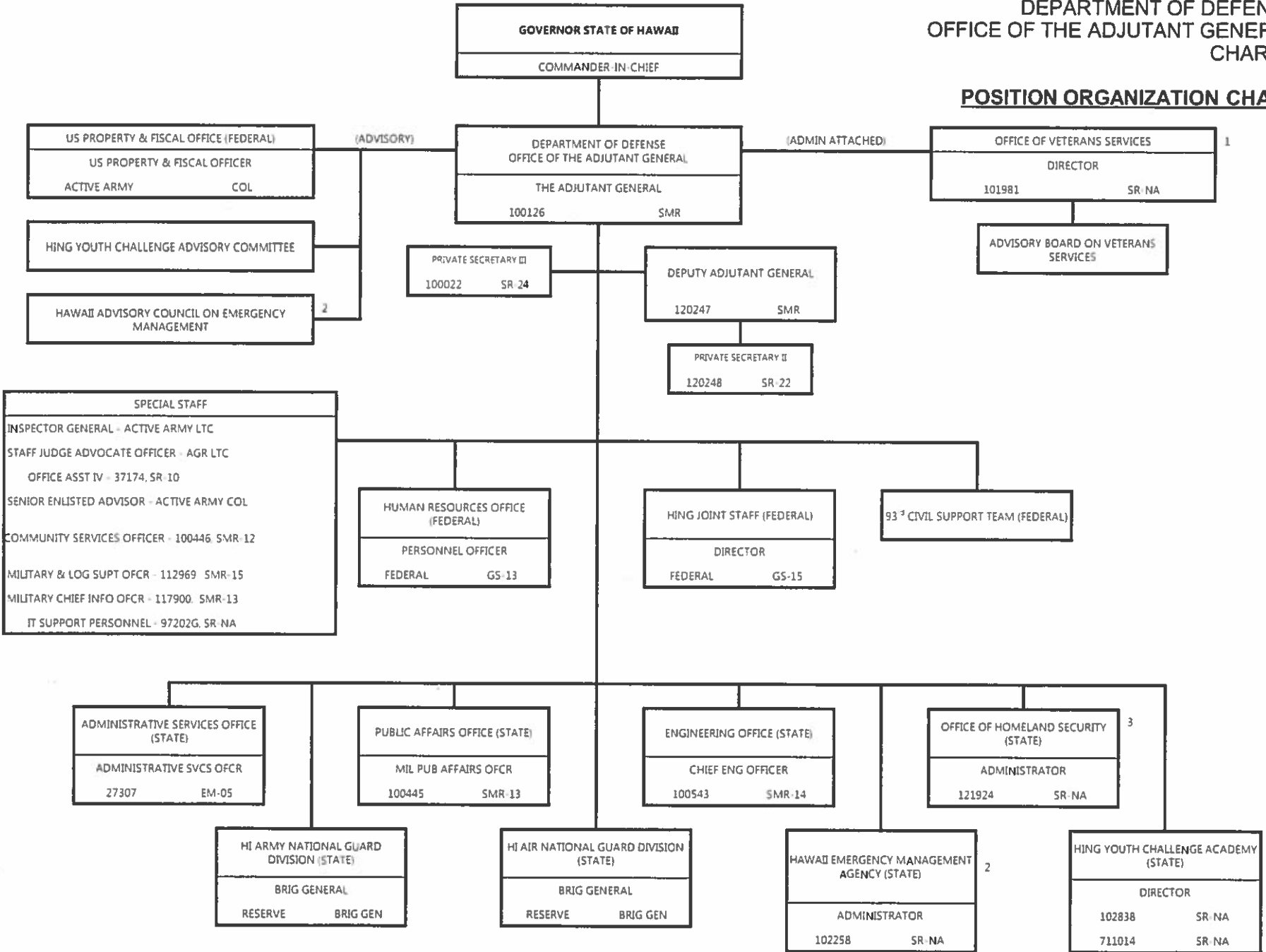

1 - Administratively attached per Act 115, SLH 1988  
 2 - Renamed per Act 111, SLH 2014  
 3 - Created per Act 175, SLH 2013



**POSITION ORGANIZATION CHART**

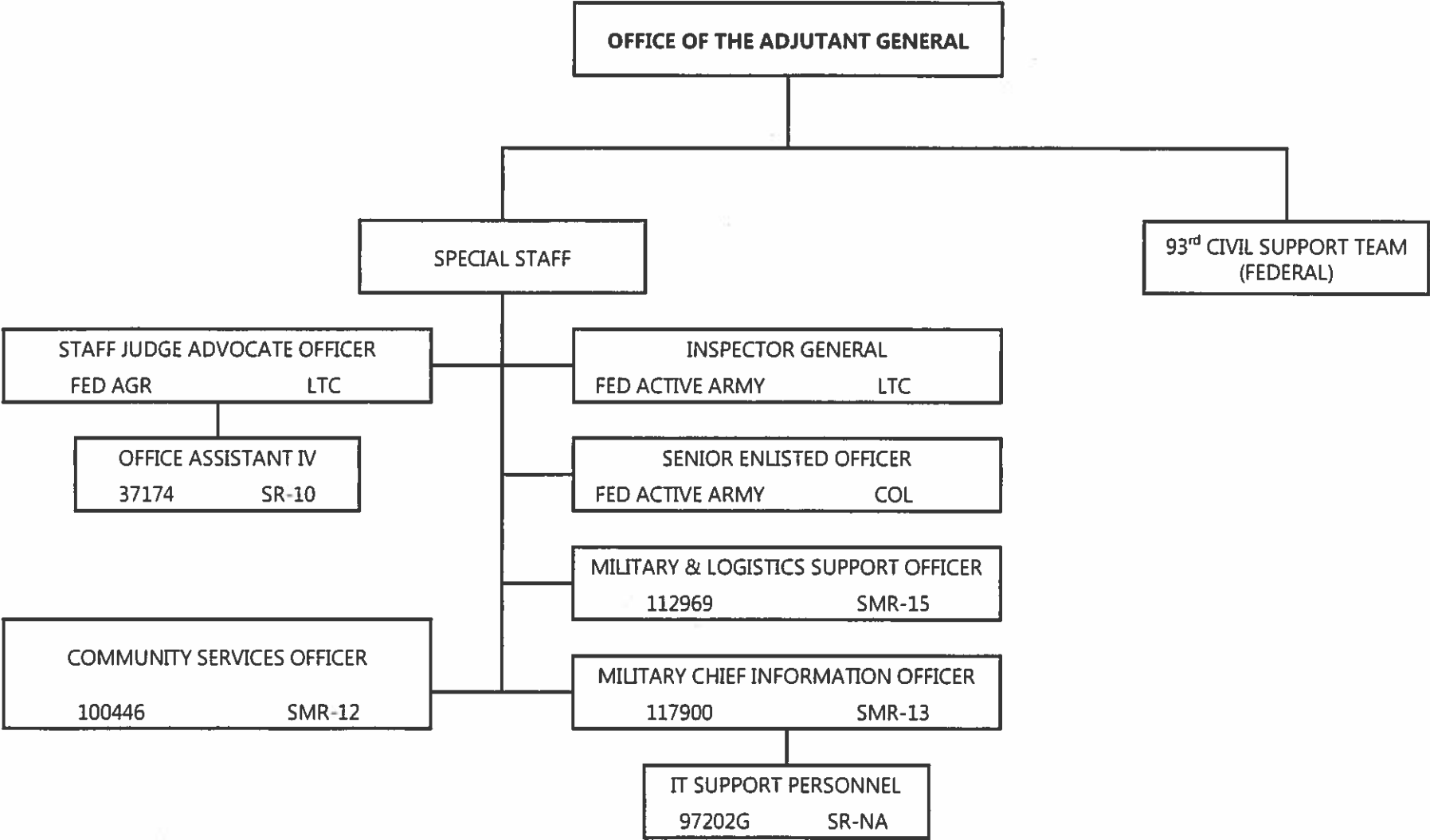

STATE OF HAWAII  
DEPARTMENT OF DEFENSE  
OFFICE OF THE ADJUTANT GENERAL  
HUMAN RESOURCES OFFICE (FEDERAL)  
CHART 3

ORGANIZATION CHART

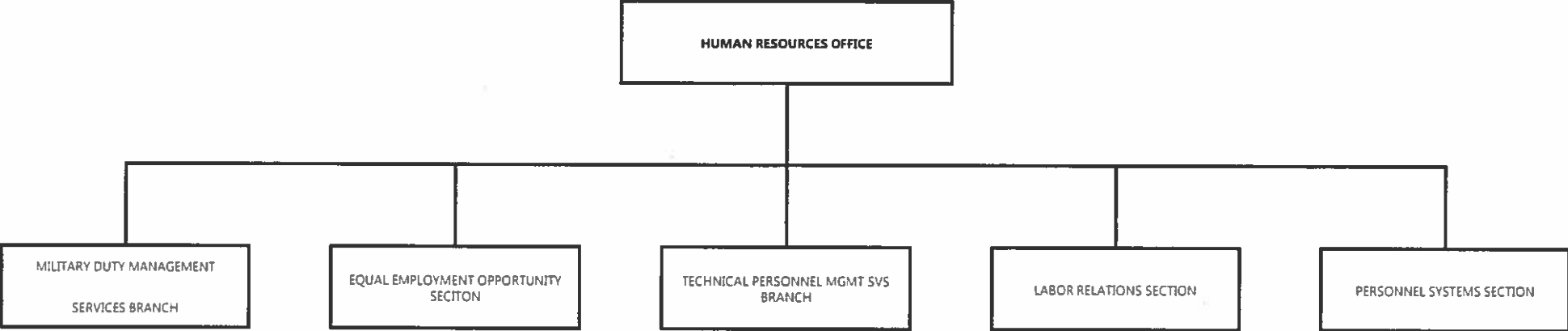

STATE OF HAWAII  
 DEPARTMENT OF DEFENSE  
 OFFICE OF THE ADJUTANT GENERAL  
 HUMAN RESOURCES OFFICE (FEDERAL)  
 CHART 4

**POSITION ORGANIZATION CHART**

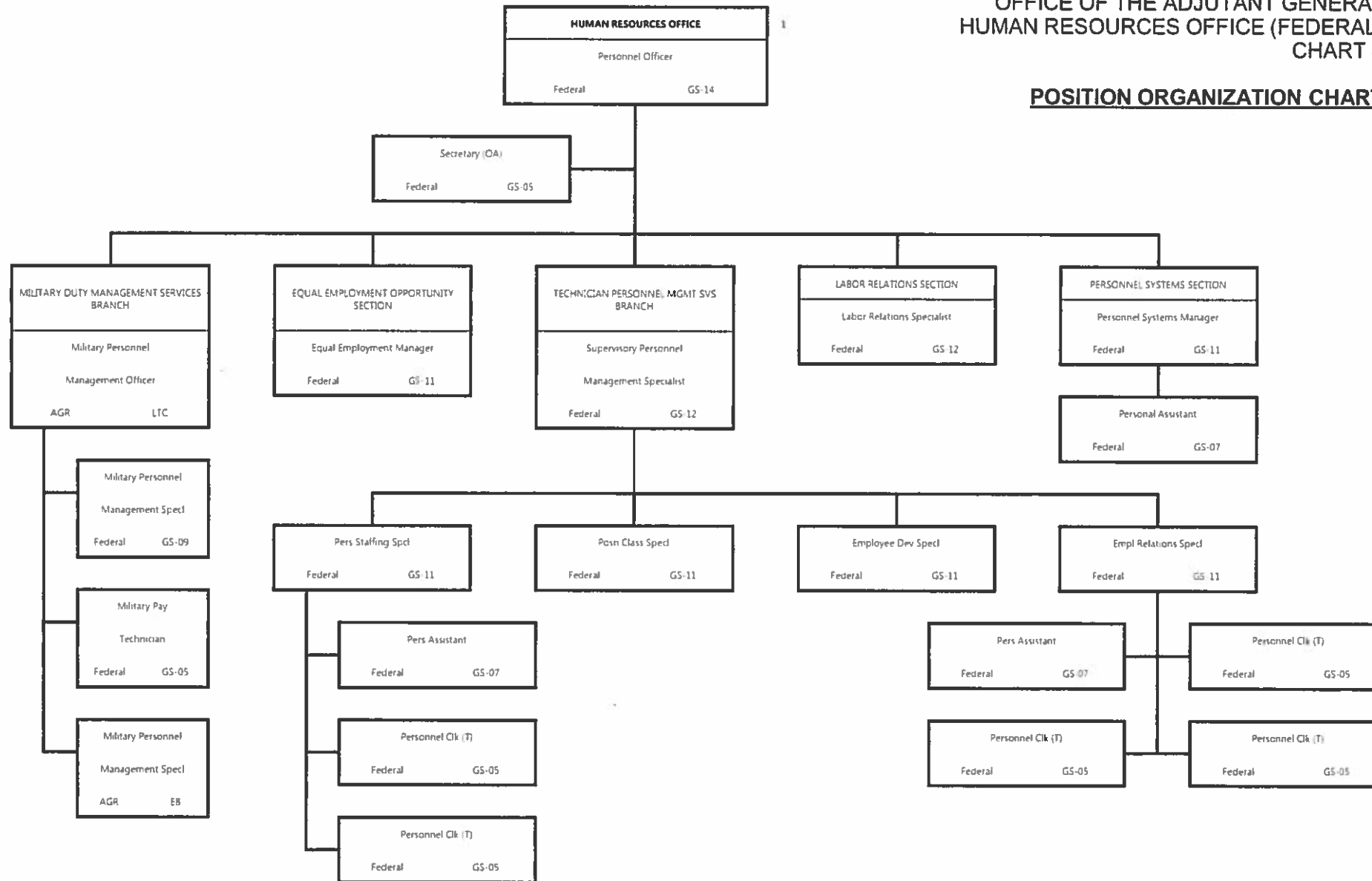

1 – All assigned personnel are Federal employees

STATE OF HAWAII  
DEPARTMENT OF DEFENSE  
OFFICE OF THE ADJUTANT GENERAL  
JOINT STAFF (FEDERAL)  
CHART 10

ORGANIZATION CHART

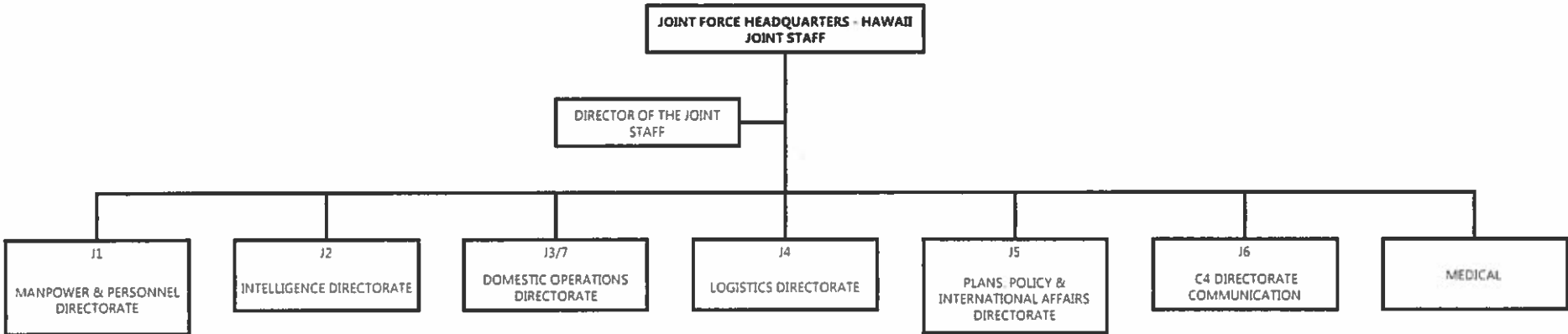

STATE OF HAWAII  
 DEPARTMENT OF DEFENSE  
 OFFICE OF THE ADJUTANT GENERAL  
 HING JOINT STAFF (FEDERAL)  
 CHART 11

**POSITION ORGANIZATION CHART**

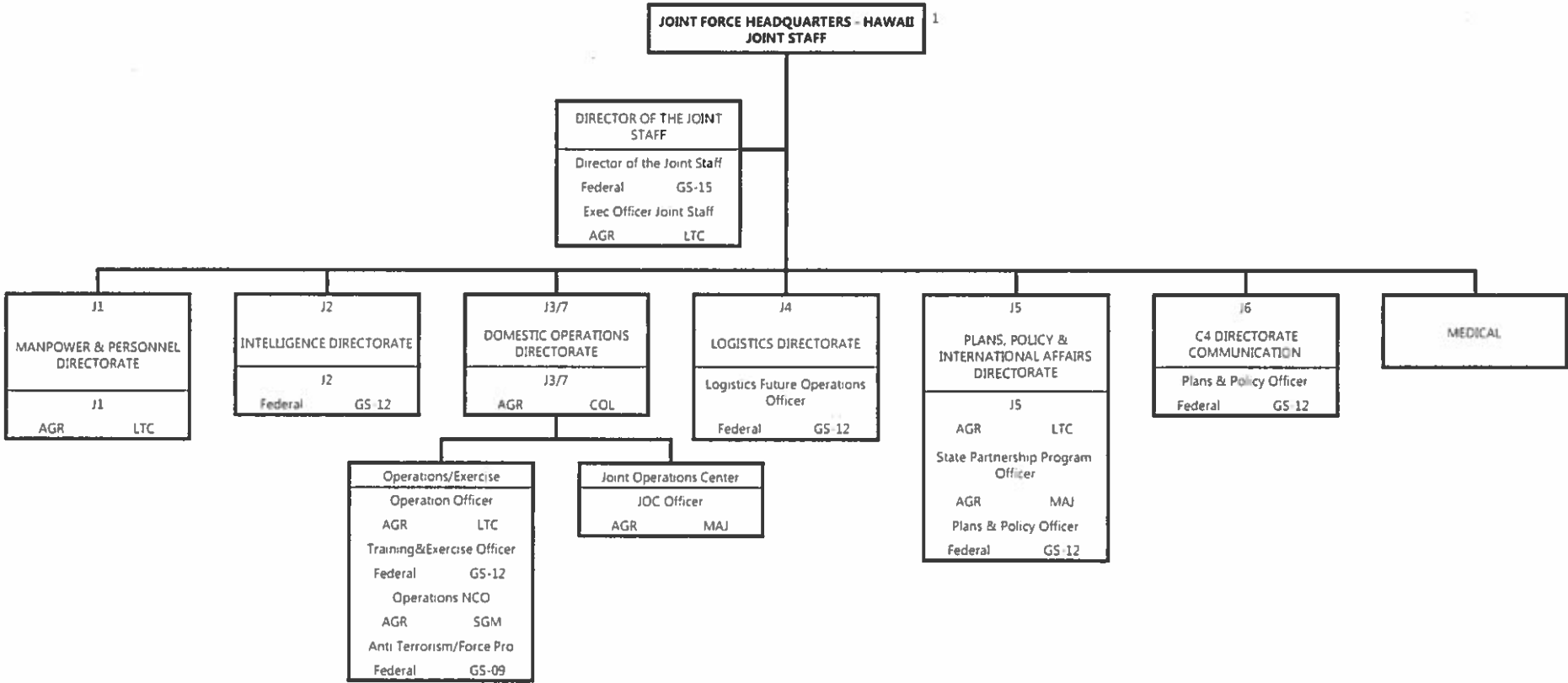

1 – All assigned personnel are Federal employees

ORGANIZATION CHART

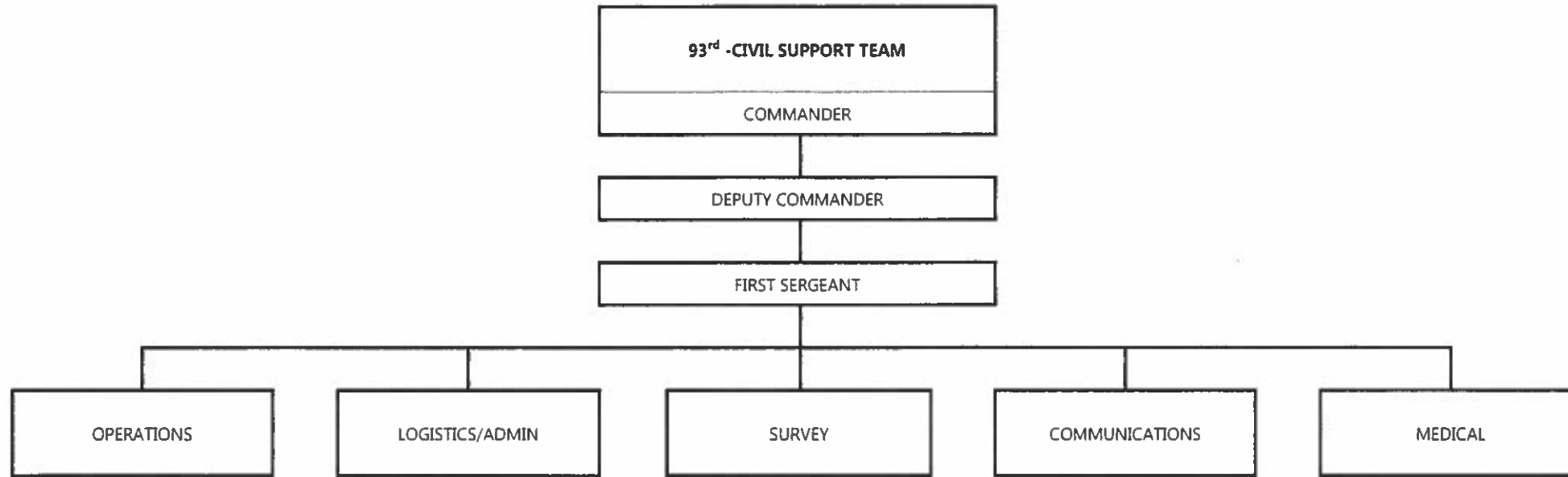

STATE OF HAWAII  
 DEPARTMENT OF DEFENSE  
 93<sup>RD</sup> CIVIL SUPPORT TEAM  
 CHART NO. 13

**POSITION ORGANIZATION CHART**

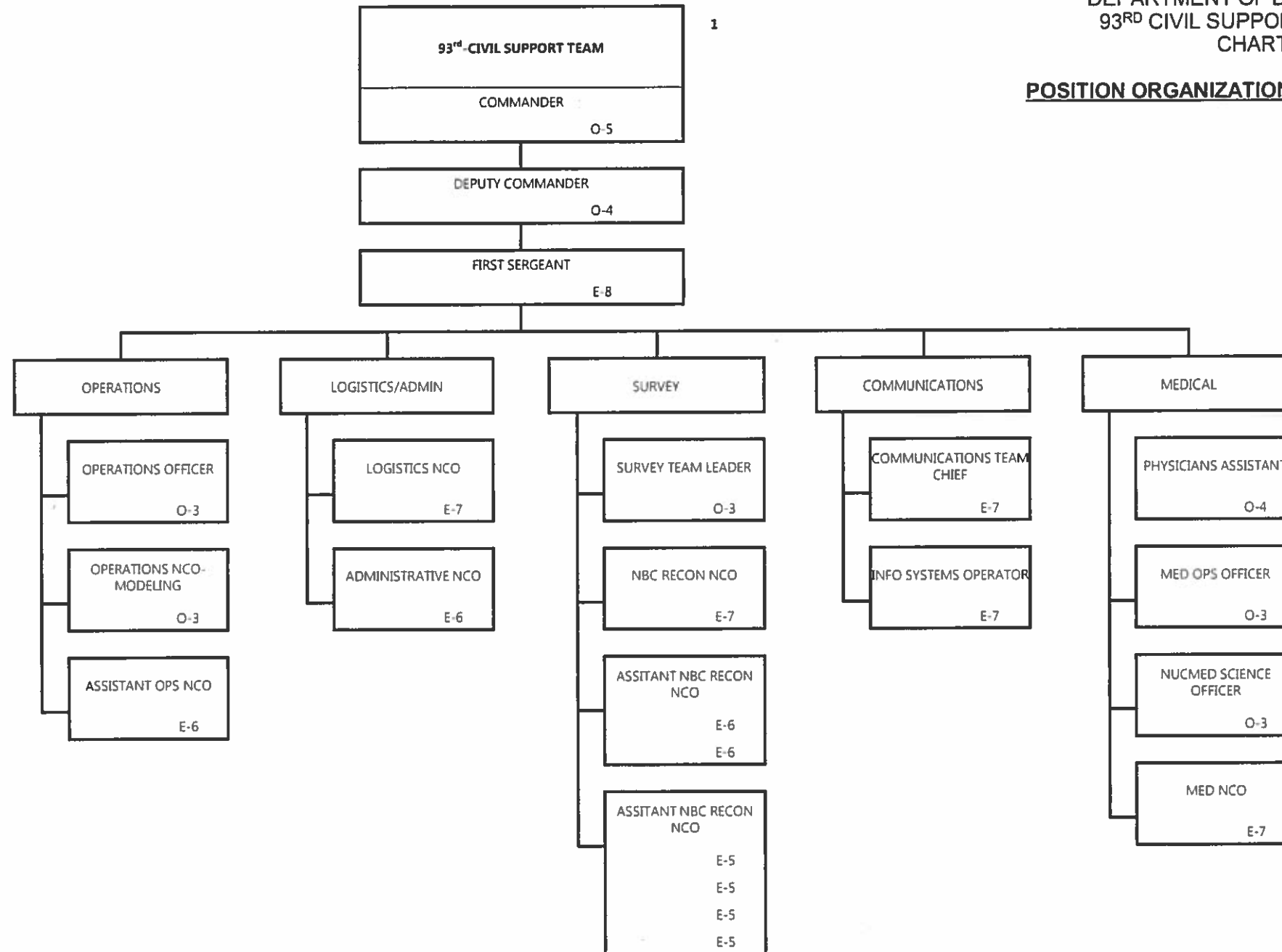

**ORGANIZATION CHART**

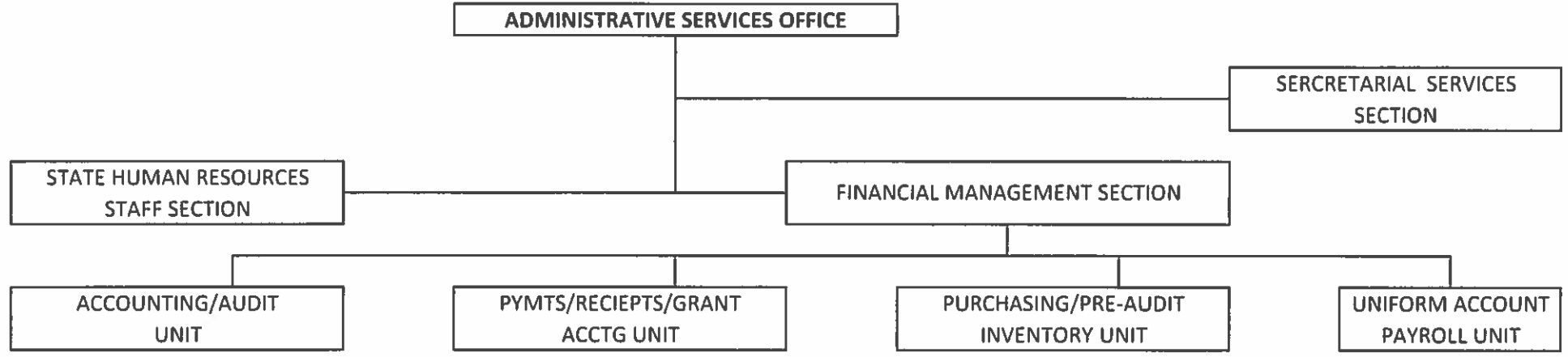



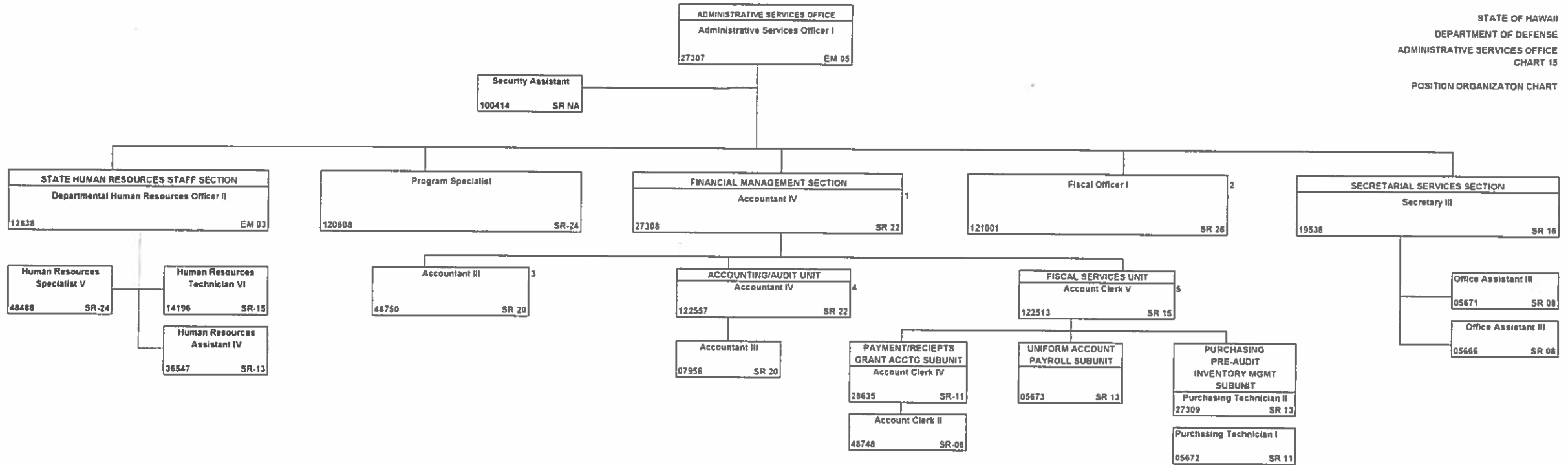

1. Position to be re-described to Accountant V, SR-24
2. Position to be re-described to Budget Analyst V, SR-24
3. Position to be re-described to Accountant IV, SR-22
4. Authorized per Act 49, SLH 2017
5. Authorized per Act 49, SLH 2017

STATE OF HAWAII  
DEPARTMENT OF DEFENSE  
OFFICE OF THE ADJUTANT GENERAL  
PUBLIC AFFAIRS OFFICE  
CHART 16

ORGANIZATION CHART



STATE OF HAWAII  
DEPARTMENT OF DEFENSE  
OFFICE OF THE ADJUTANT GENERAL  
PUBLIC AFFAIRS OFFICE  
CHART 17

POSITION ORGANIZATION CHART

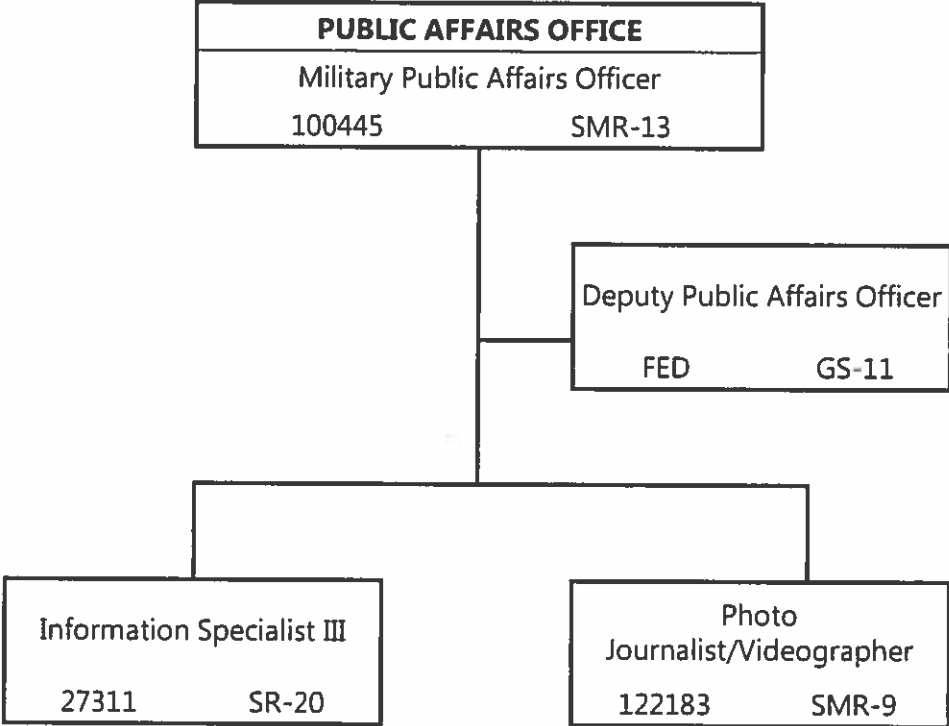

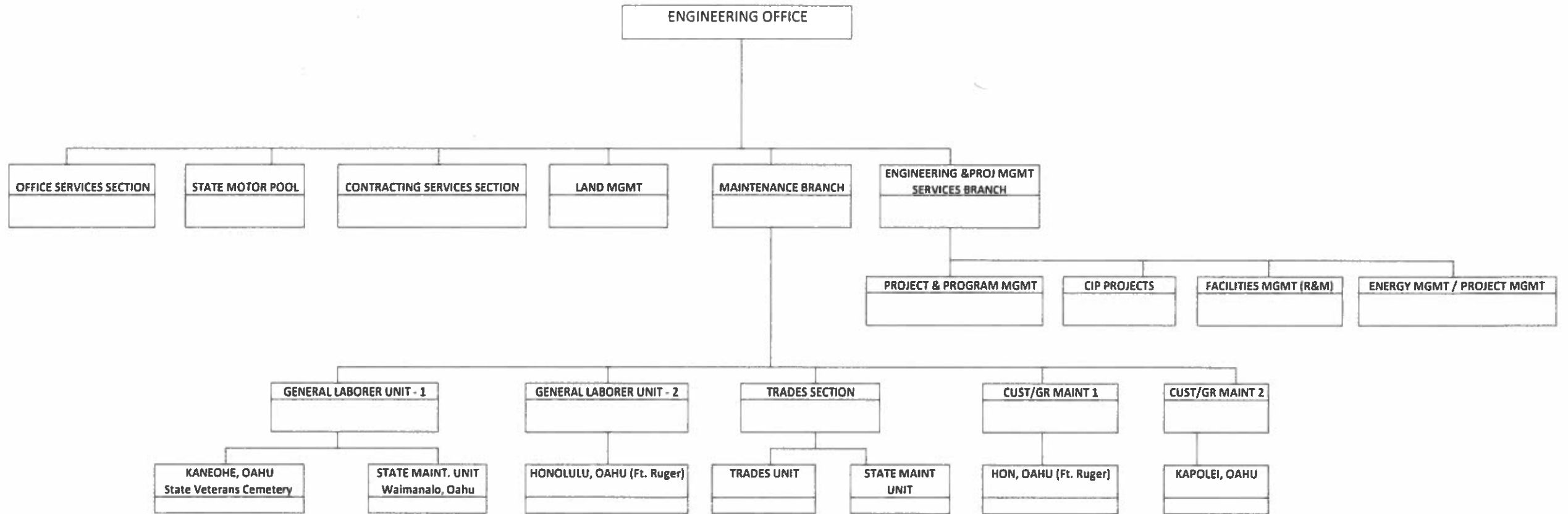

STATE OF HAWAII  
DEPARTMENT OF DEFENSE  
ENGINEERING OFFICE  
CHART NO. 19

POSITION ORGANIZATION CHART

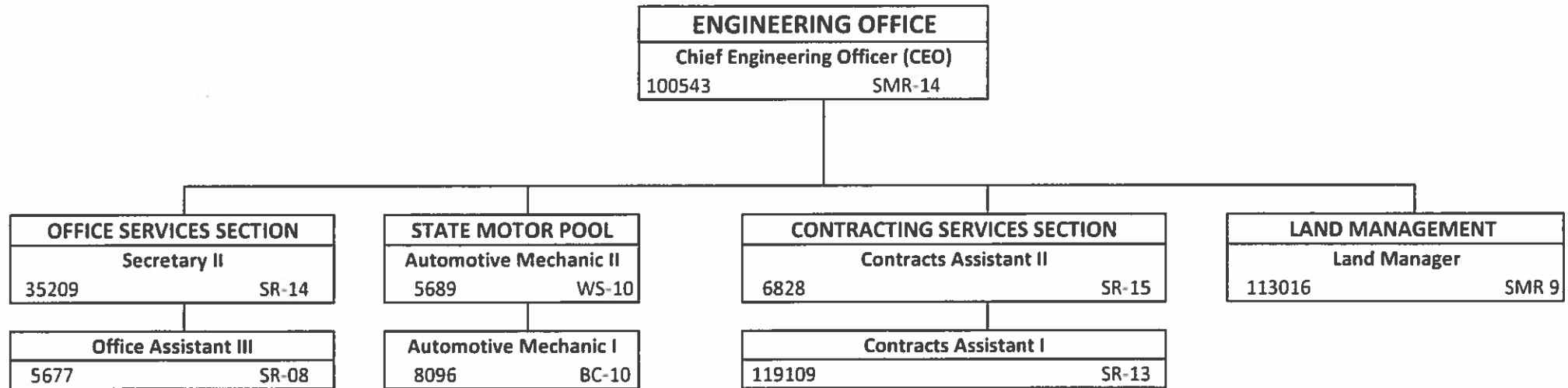

STATE OF HAWAII  
 DEPARTMENT OF DEFENSE  
 ENGINEERING OFFICE  
 ENGINEERING & PROJECT MANAGEMENT SERVICES BRANCH  
 CHART NO. 20  
 POSITION ORGANIZATION CHART

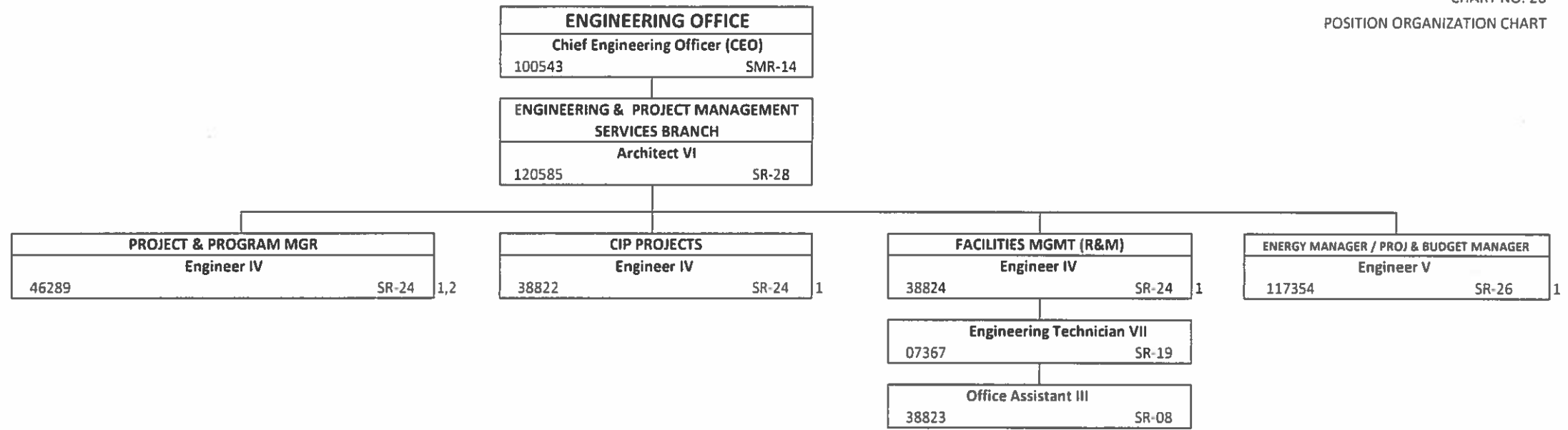

1 - Position to be redescribed.  
 2 - Position NTE 6/30/2019

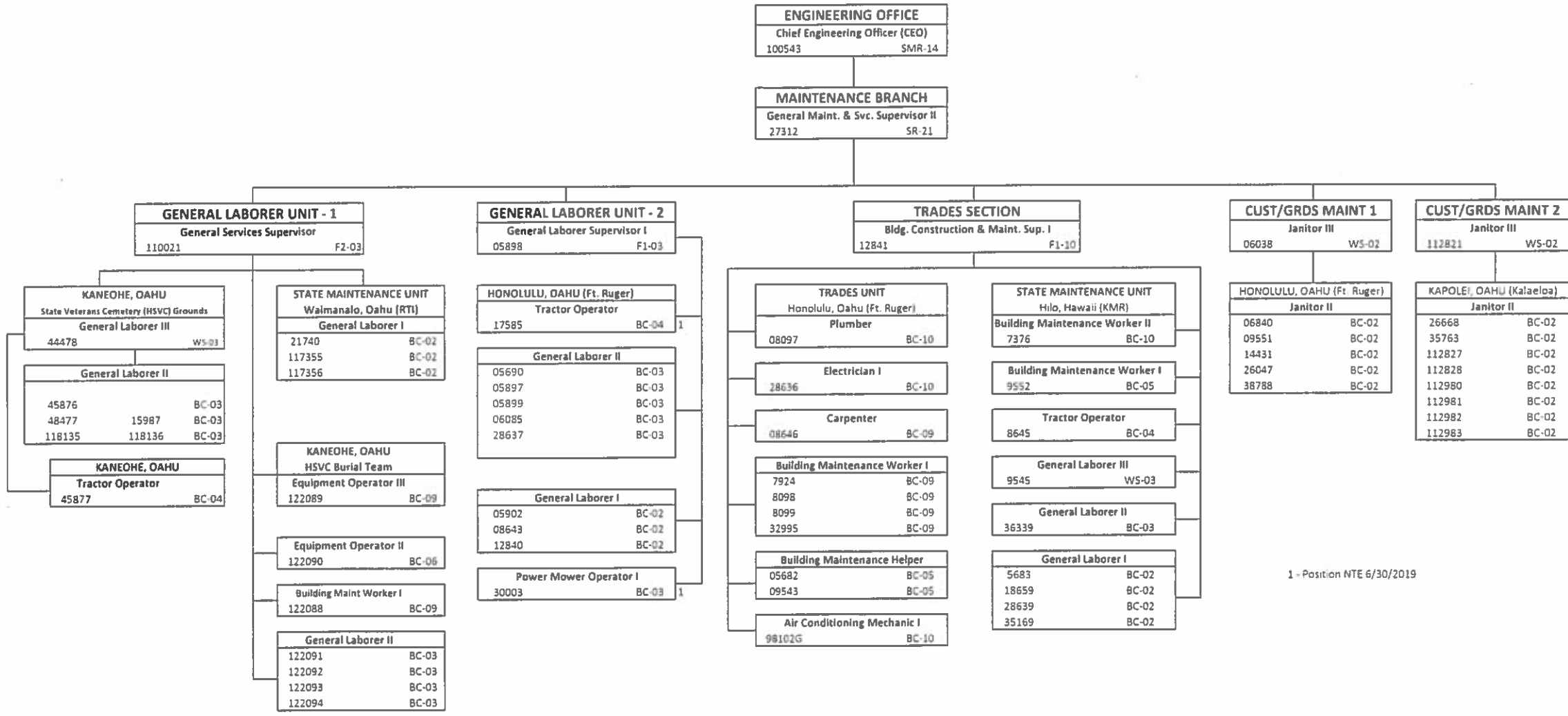

1 - Position NTE 6/30/2019

ORGANIZATION CHART

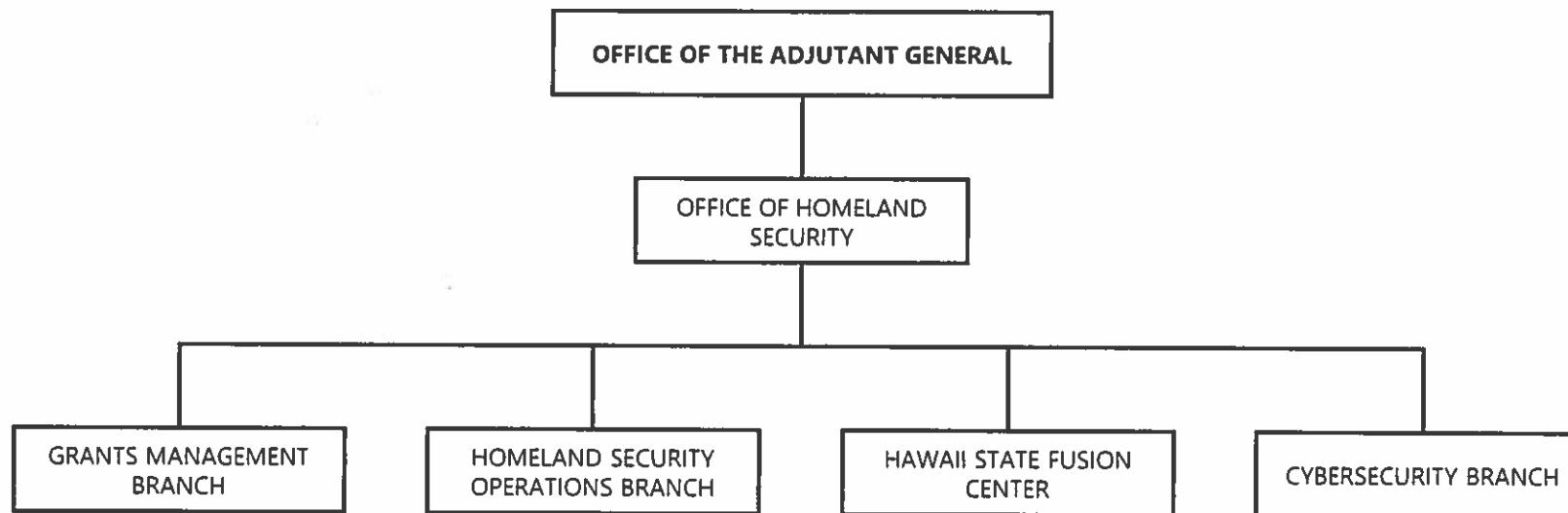



**POSITION ORGANIZATION CHART**

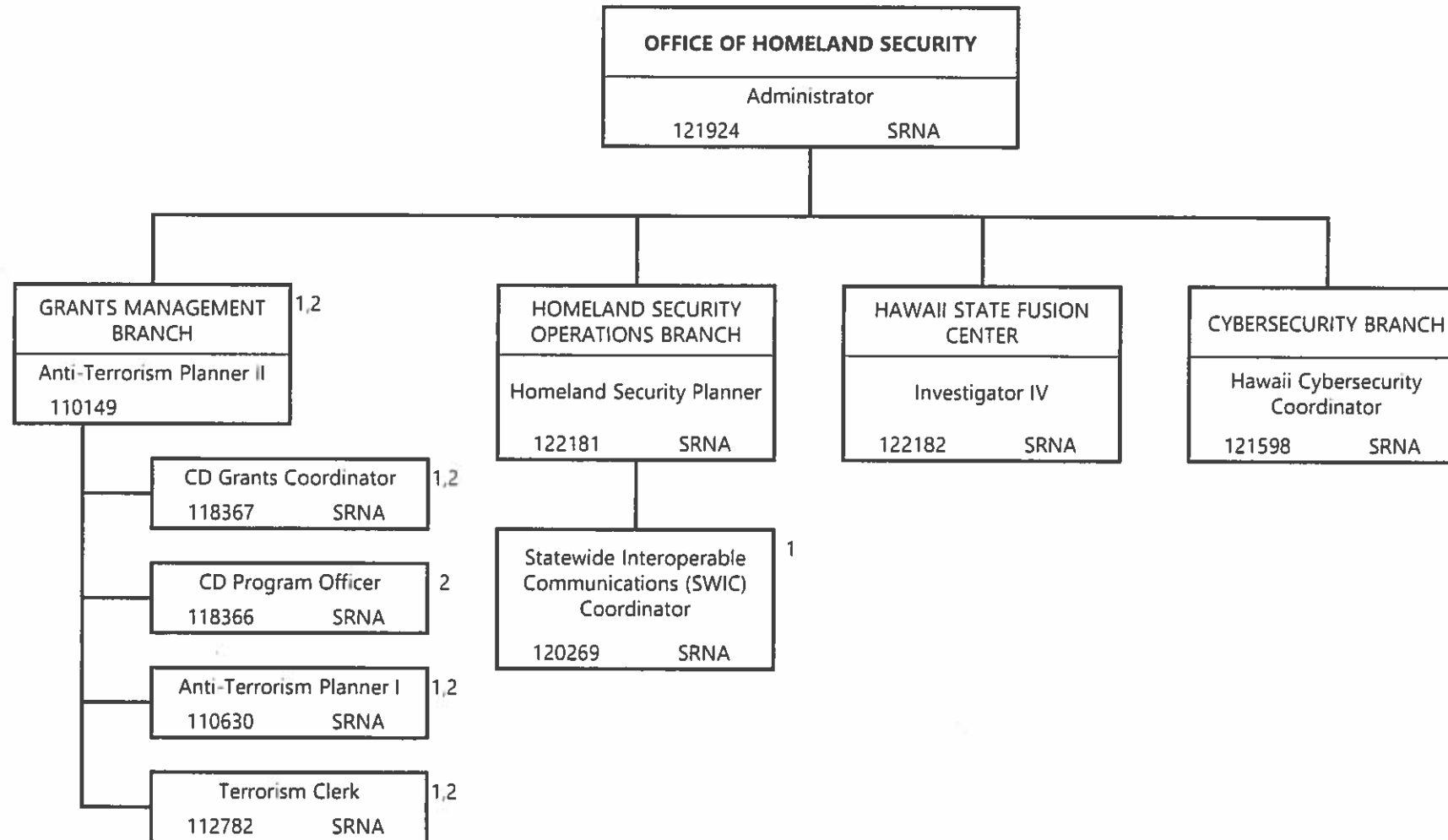

1 – Temporary position NTE 6/30/2019  
 2 – Position to be redescribed

STATE OF HAWAII  
DEPARTMENT OF DEFENSE  
ARMY NATIONAL GUARD DIVISION  
CHART NO. HIARNG 24

ORGANIZATION CHART

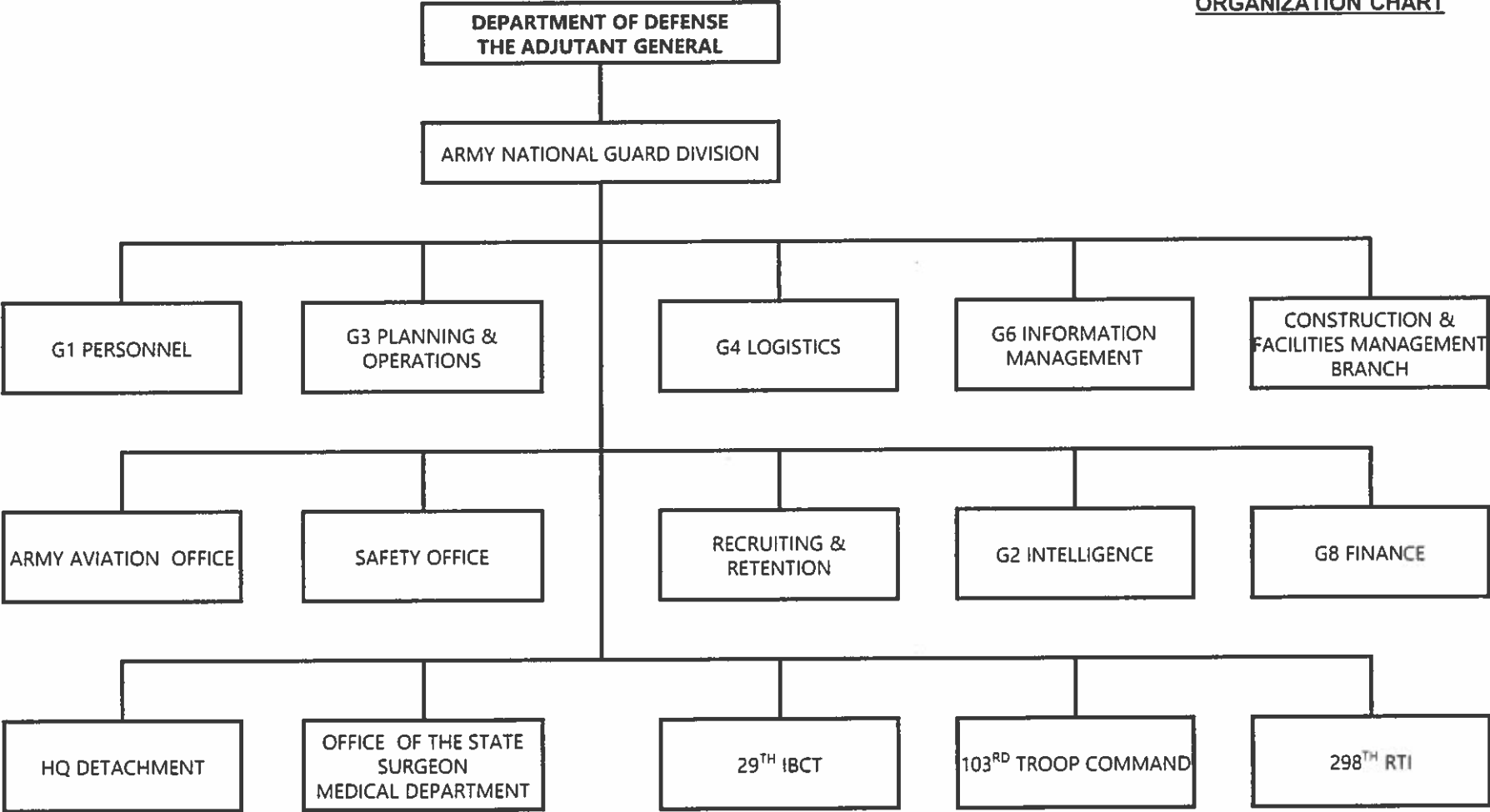

POSITION ORGANIZATION CHART

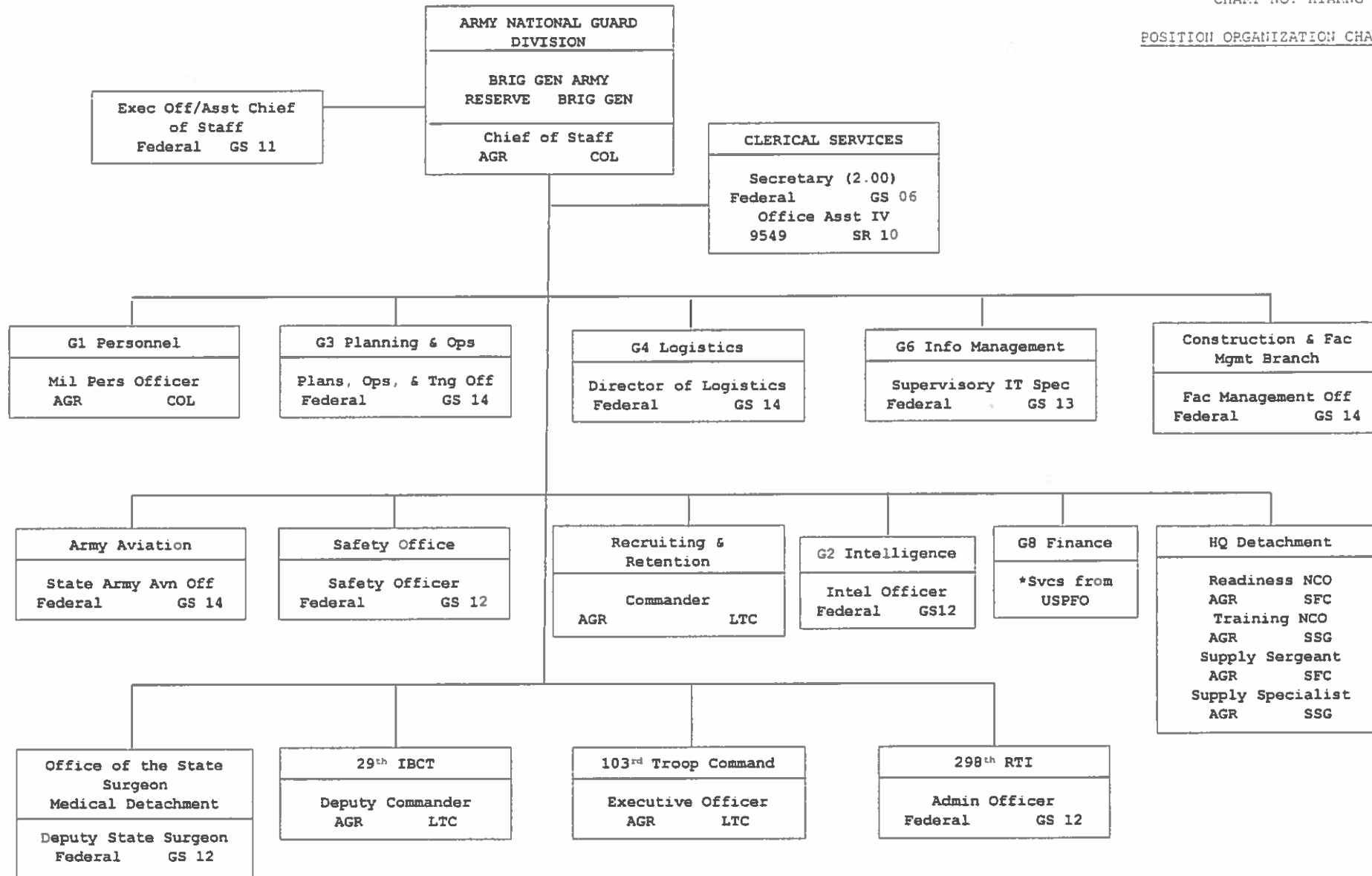

ORGANIZATION CHART

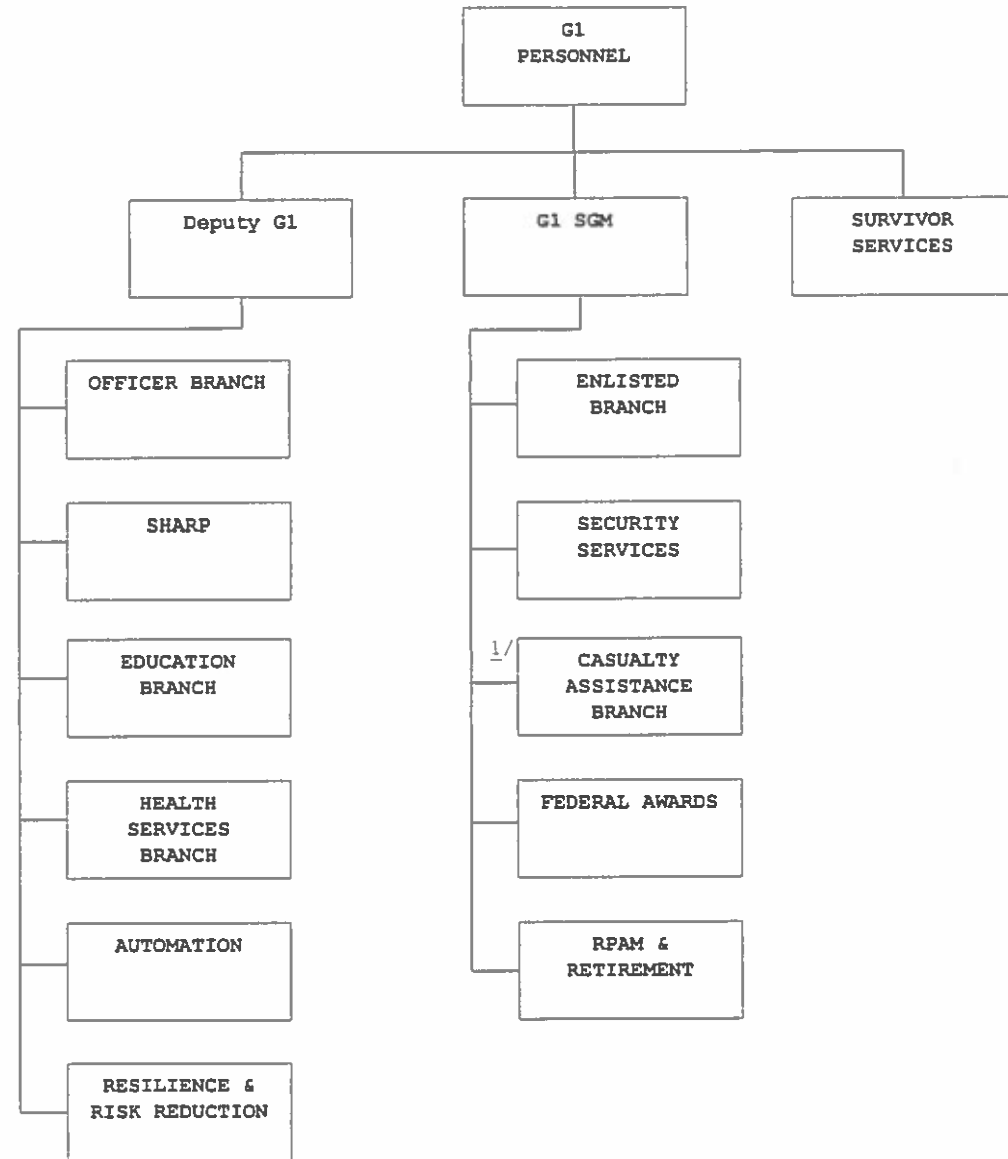

Notes:

<sup>1/</sup> Drill Status function only

POSITION ORGANIZATION CHART

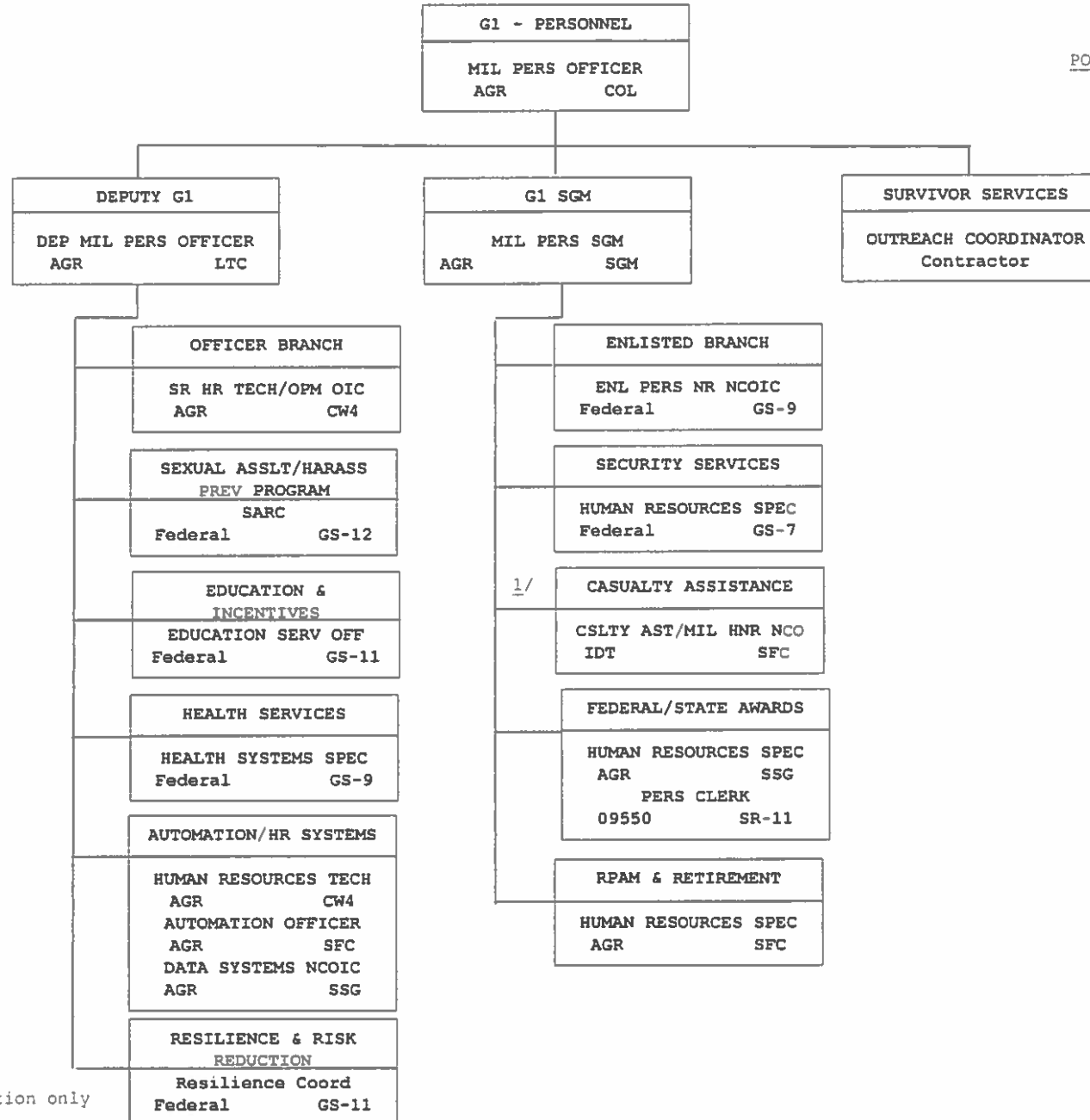

Notes:

1/ Drill Status function only



STATE OF HAWAII  
DEPARTMENT OF DEFENSE  
ARMY NATIONAL GUARD DIVISION  
G1 PERSONNEL  
EDUCATION & INCENTIVES  
CHART NO. HIARNG 29

POSITION ORGANIZATION CHART

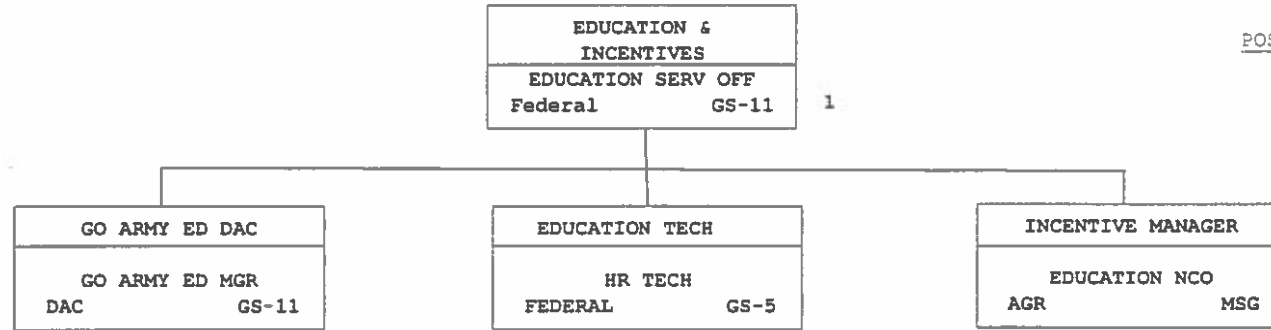

1 All assigned personnel are Federal employees

STATE OF HAWAII  
DEPARTMENT OF DEFENSE  
ARMY NATIONAL GUARD DIVISION  
G1 PERSONNEL  
ENLISTED BRANCH  
CHART NO. HIARNG 30

POSITION ORGANIZATION CHART

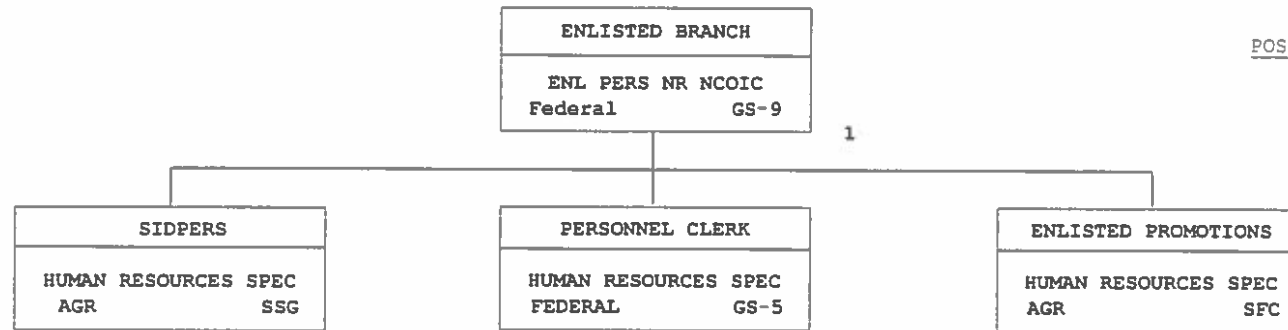

1 All assigned personnel are Federal employees.



ORGANIZATION CHART

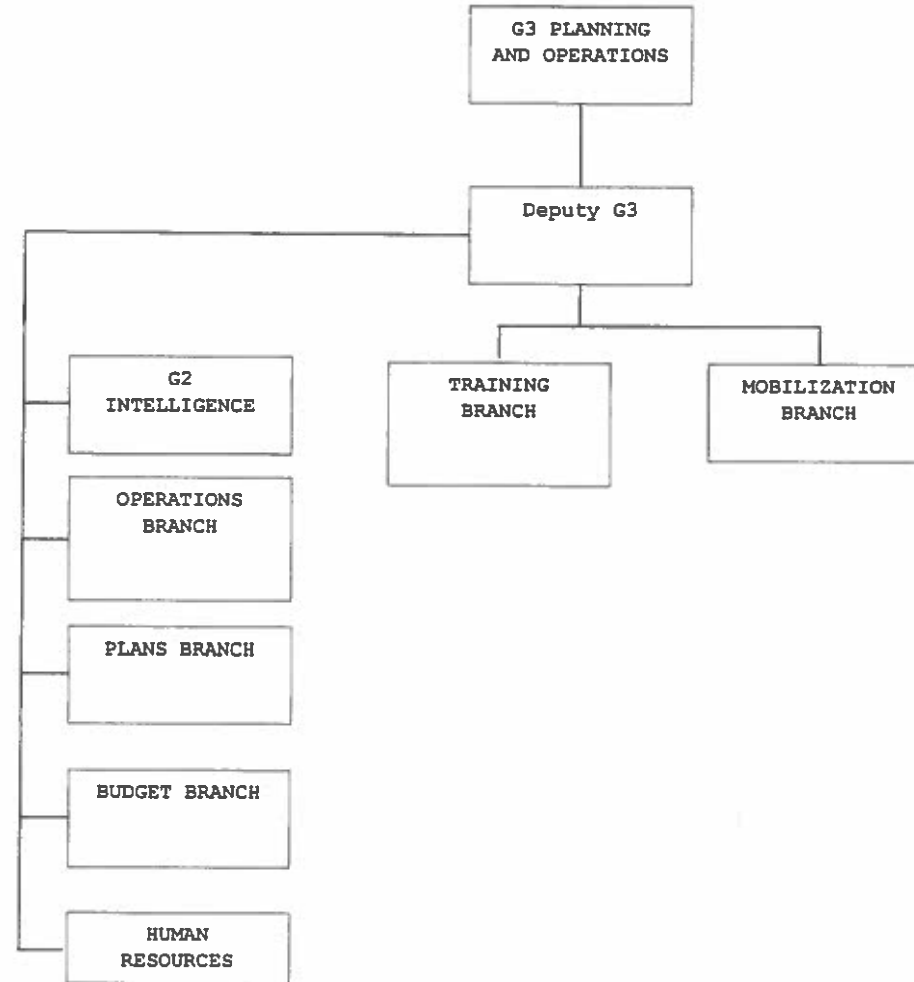

POSITION ORGANIZATION CHART

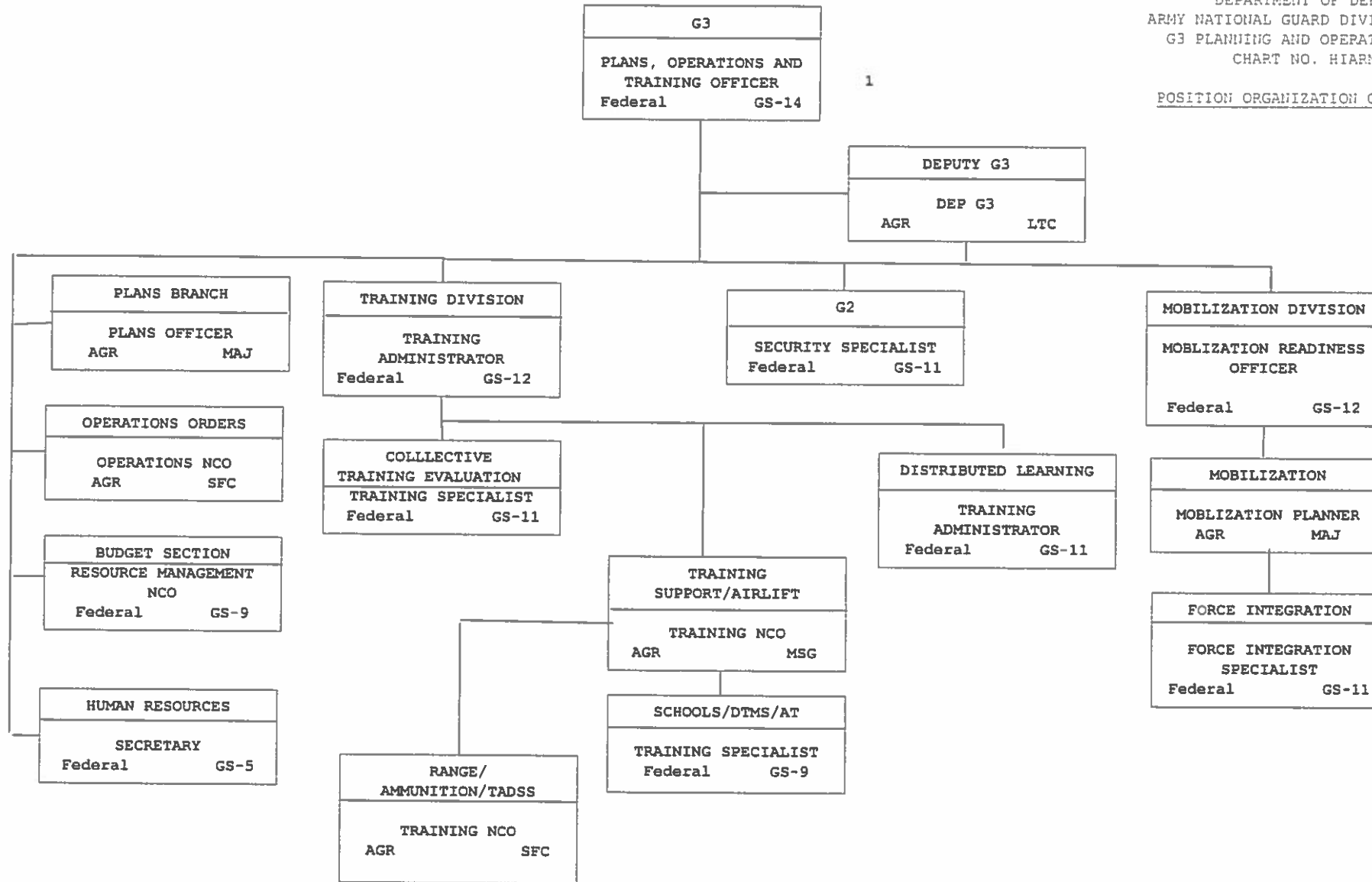

1 All assigned personnel are Federal employees.

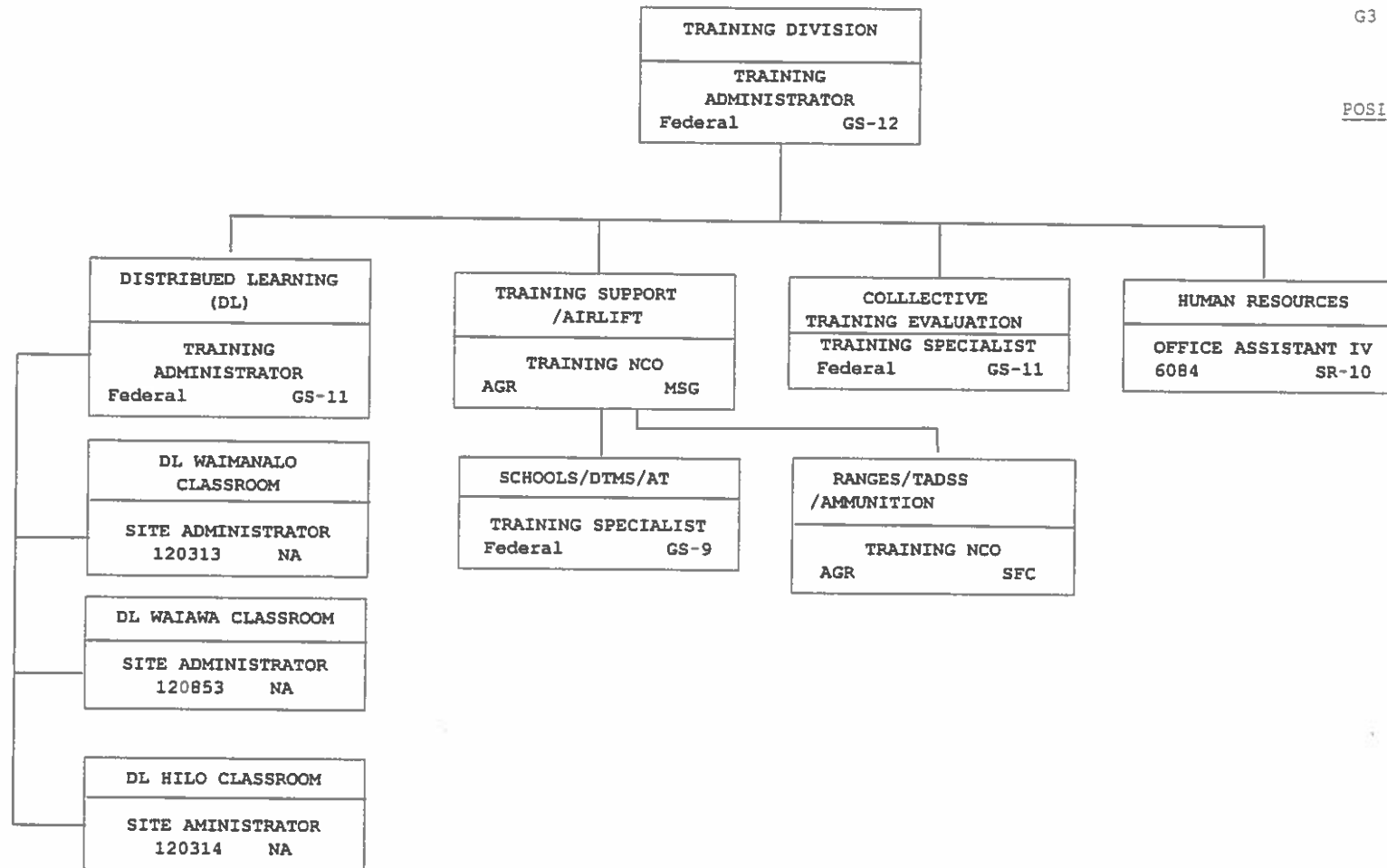

STATE OF HAWAII  
DEPARTMENT OF DEFENSE  
ARMY NATIONAL GUARD DIVISION  
G3 PLANNING AND OPERATIONS  
**MOBILIZATION READINESS DIVISION**  
CHART NO. HIARNG 34

POSITION ORGANIZATION CHART

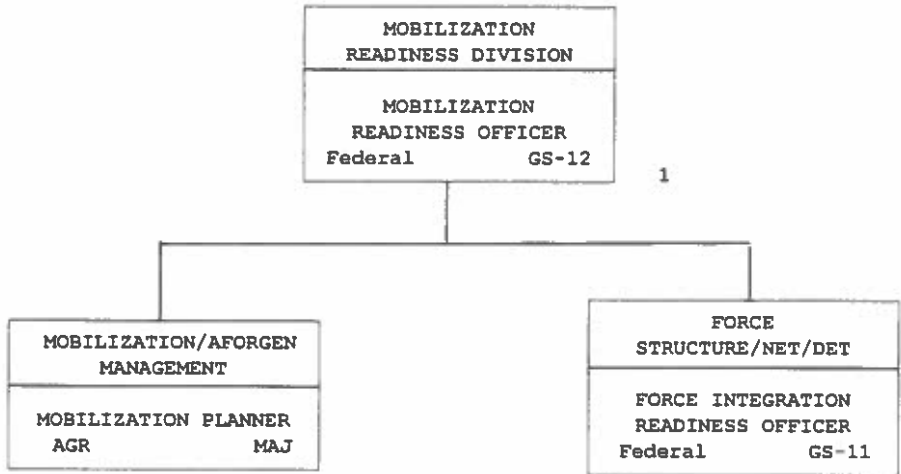

1 All assigned personnel are Federal employees.

ORGANIZATION CHART

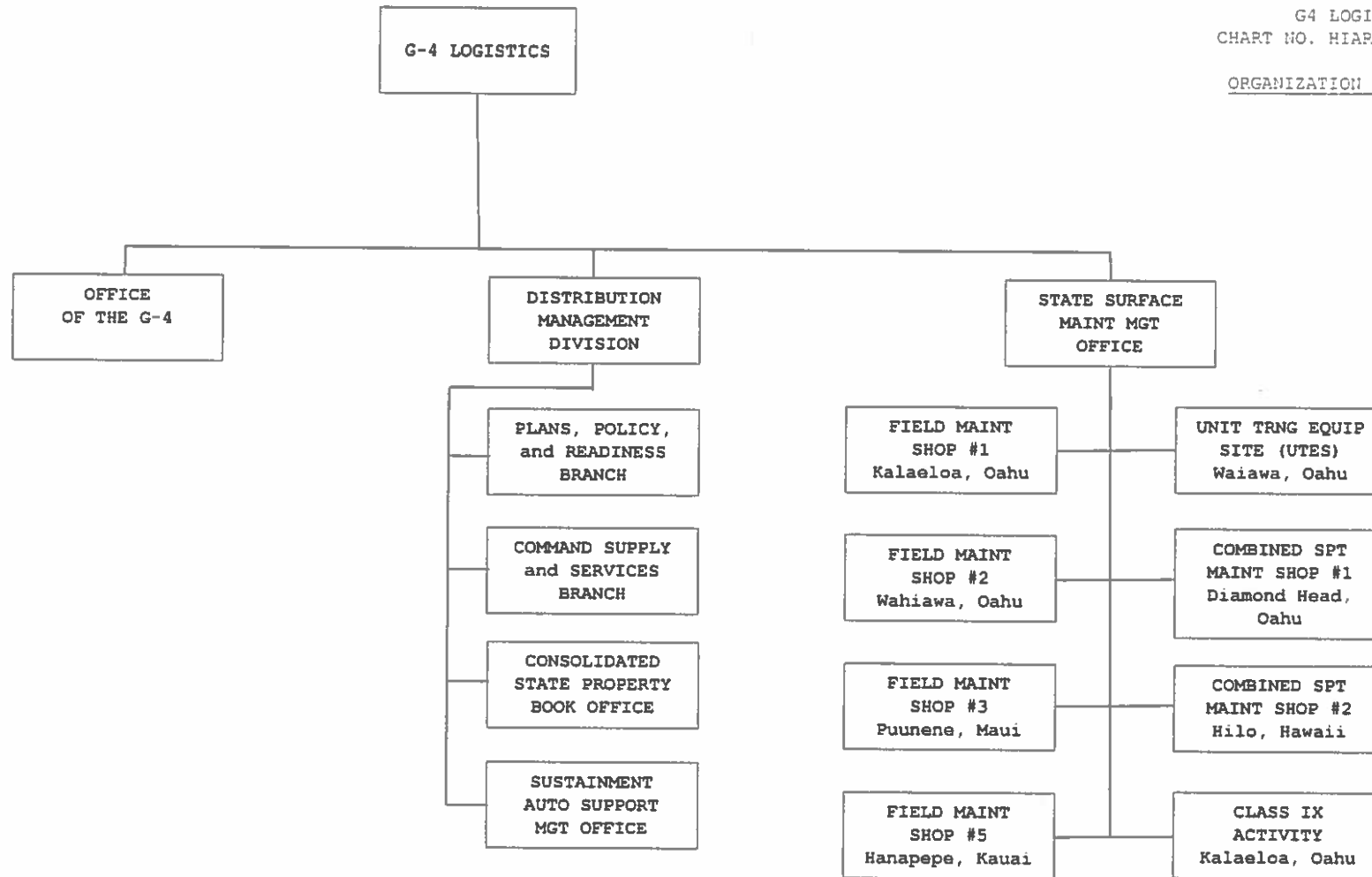

POSITION ORGANIZATION CHART

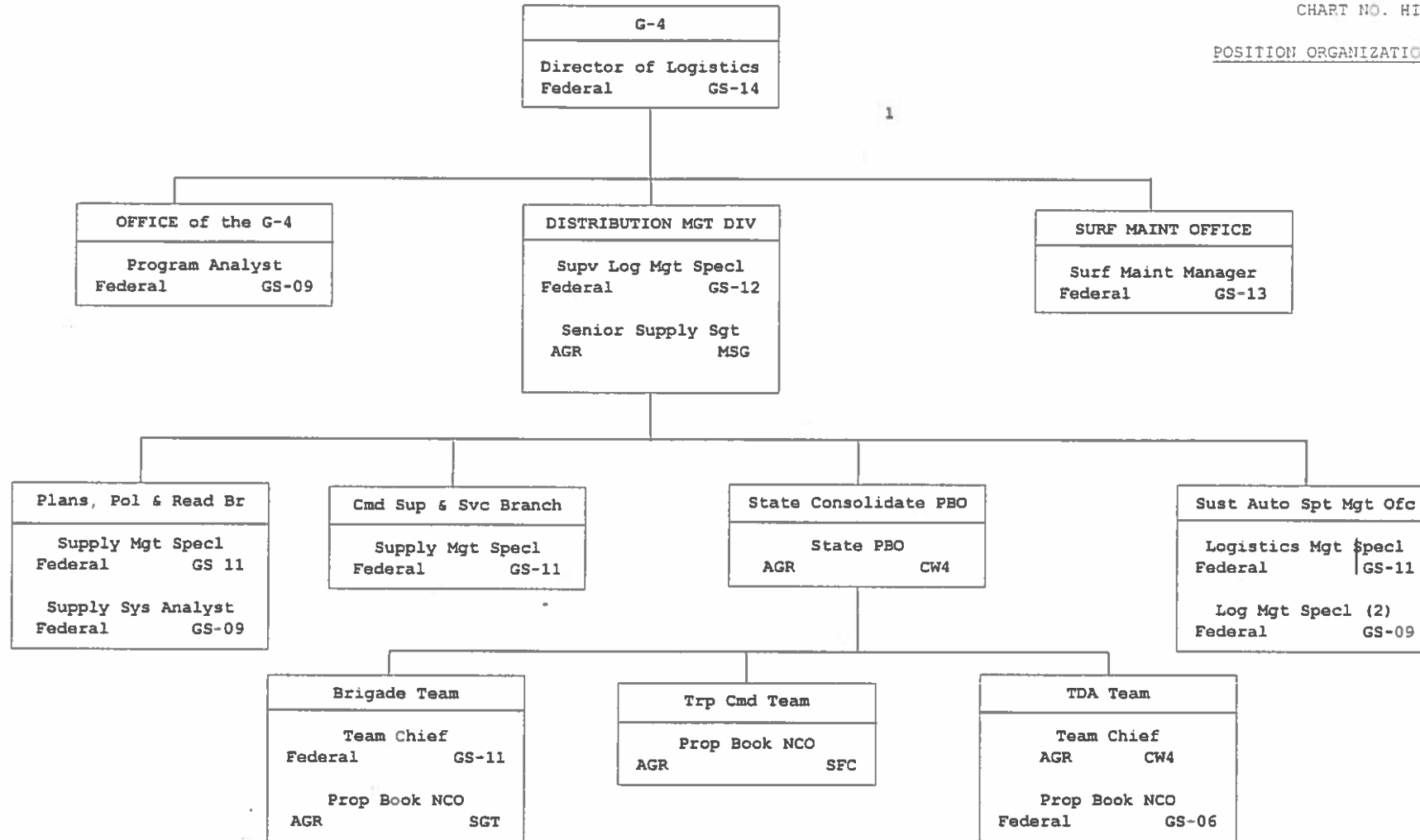

1 All assigned personnel are Federal employees.

POSITION ORGANIZATION CHART

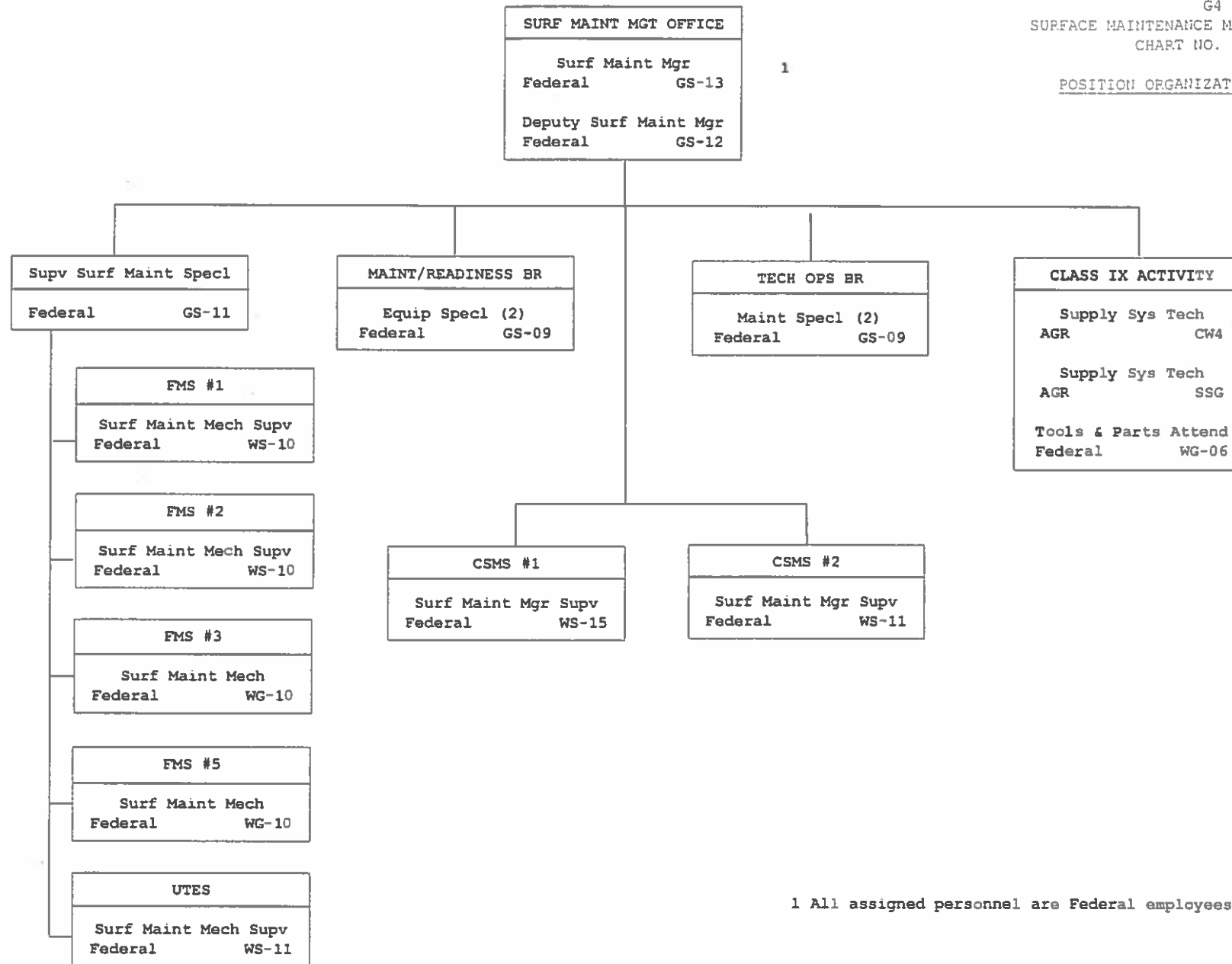

1 All assigned personnel are Federal employees.

POSITION ORGANIZATION CHART

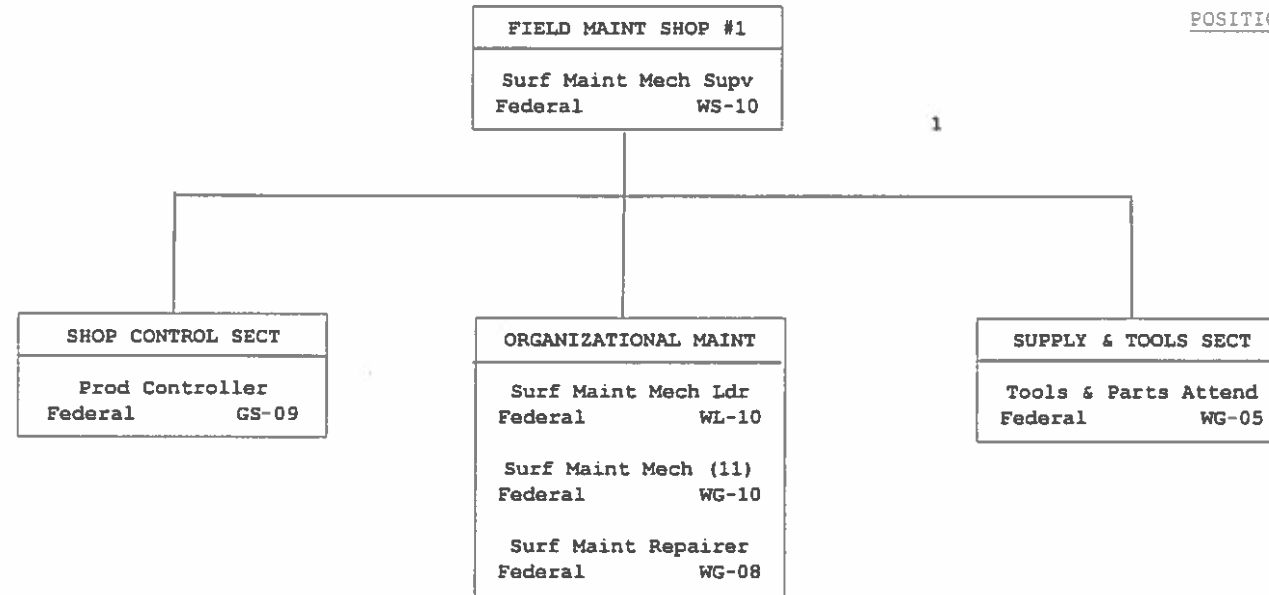

1 All assigned personnel are Federal employees.



POSITION ORGANIZATION CHART

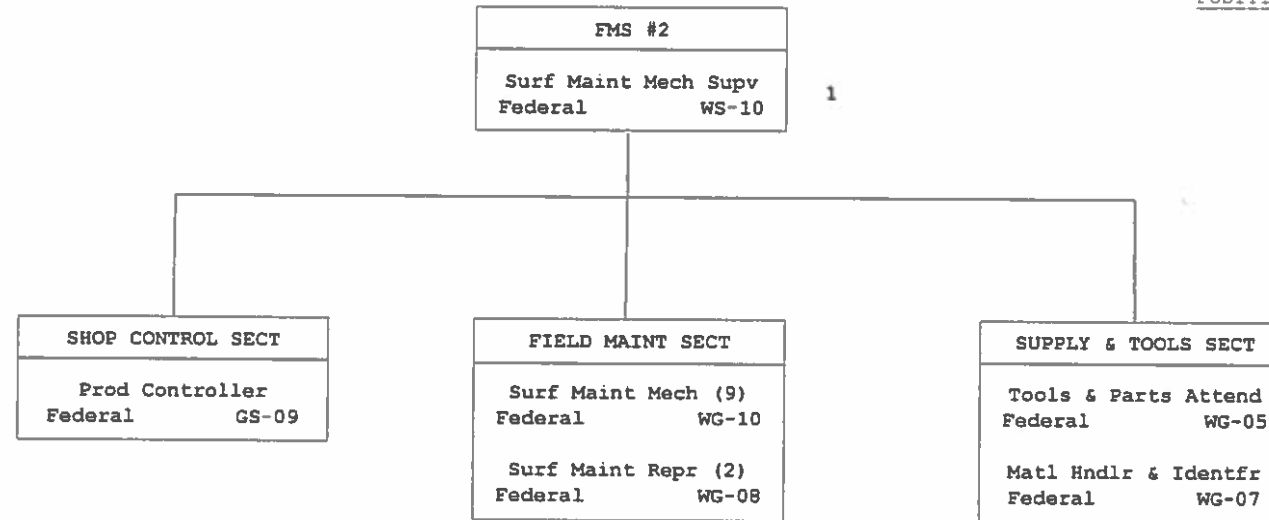

1 All assigned personnel are Federal employees.

STATE OF HAWAII  
 DEPARTMENT OF DEFENSE  
 ARMY NATIONAL GUARD DIVISION  
 G4 LOGISTICS  
 SURFACE MAINTENANCE MANAGEMENT  
 UNIT TRAINING EQUIPMENT SITE  
 CHART NO. HIARNG 40

POSITION ORGANIZATION CHART

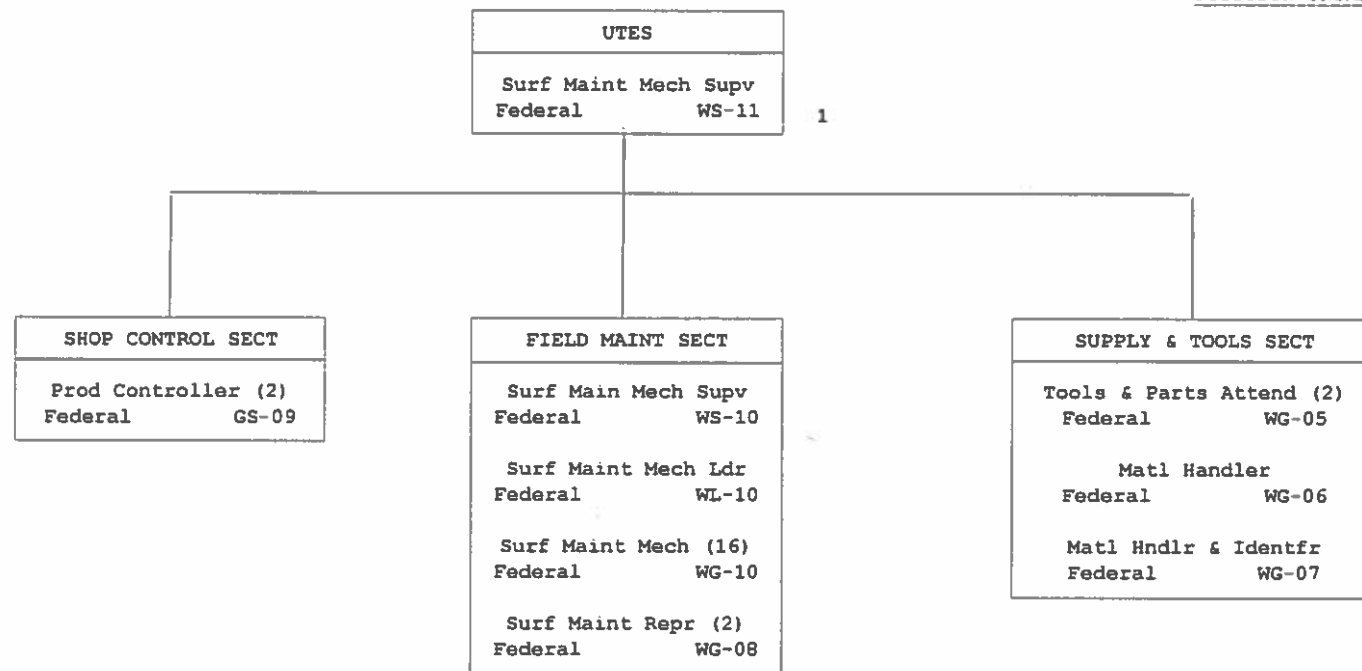

1 All assigned personnel are Federal employees.

STATE OF HAWAII  
 DEPARTMENT OF DEFENSE  
 ARMY NATIONAL GUARD DIVISION  
 G4 LOGISTICS  
 SURFACE MAINTENANCE MANAGEMENT  
 COMBINED SUPPORT MAINTENANCE SHOP 1  
 CHART NO. HIARNG 41

POSITION ORGANIZATION CHART

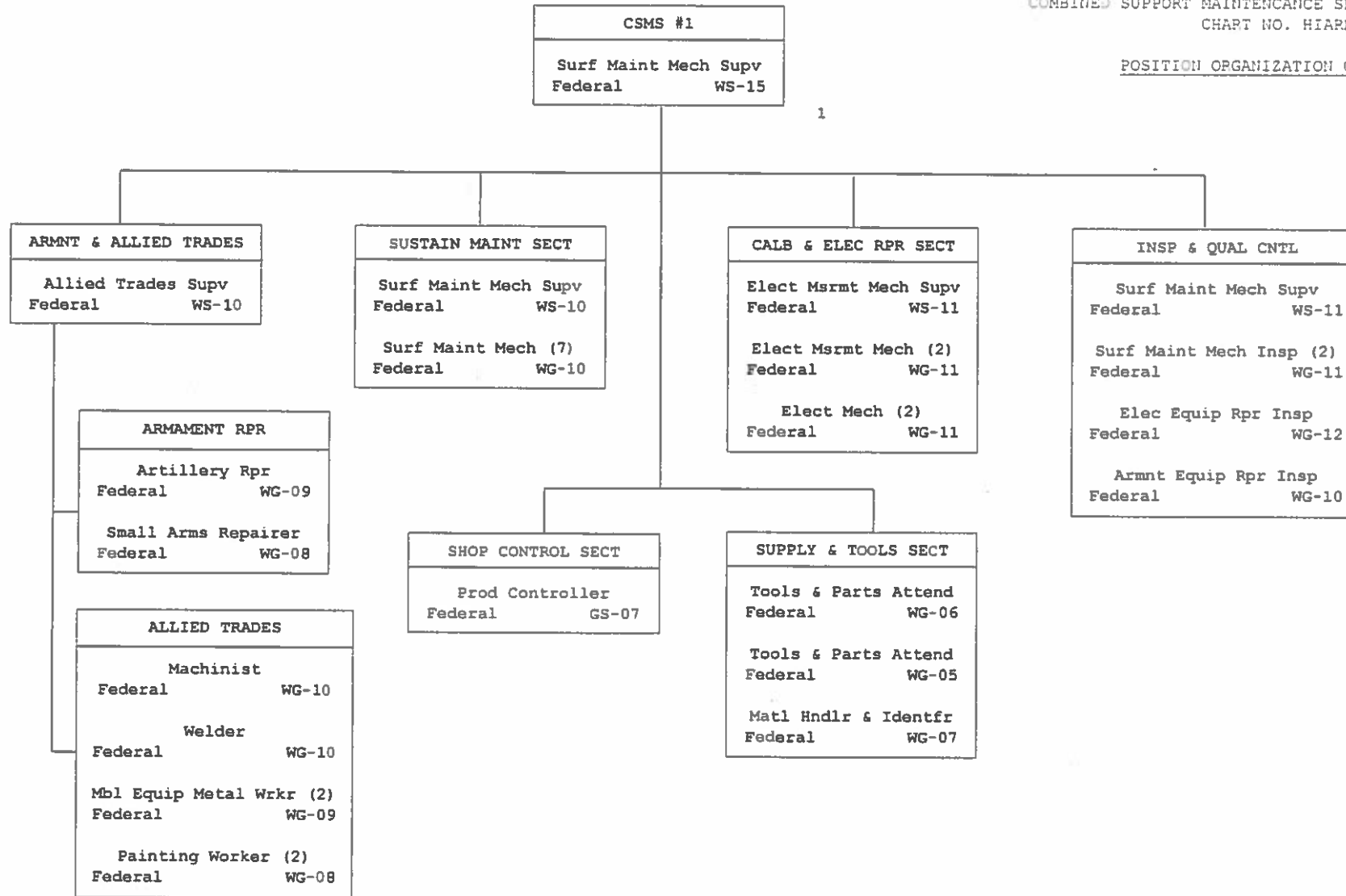

1 All assigned personnel are Federal employees.

STATE OF HAWAII  
 DEPARTMENT OF DEFENSE  
 ARMY NATIONAL GUARD DIVISION  
 G4 LOGISTICS  
 SURFACE MAINTENANCE MANAGEMENT  
 COMBINED SUPPORT MAINTENANCE SHOP 2  
 CHART NO. HIARIG 42

POSITION ORGANIZATION CHART

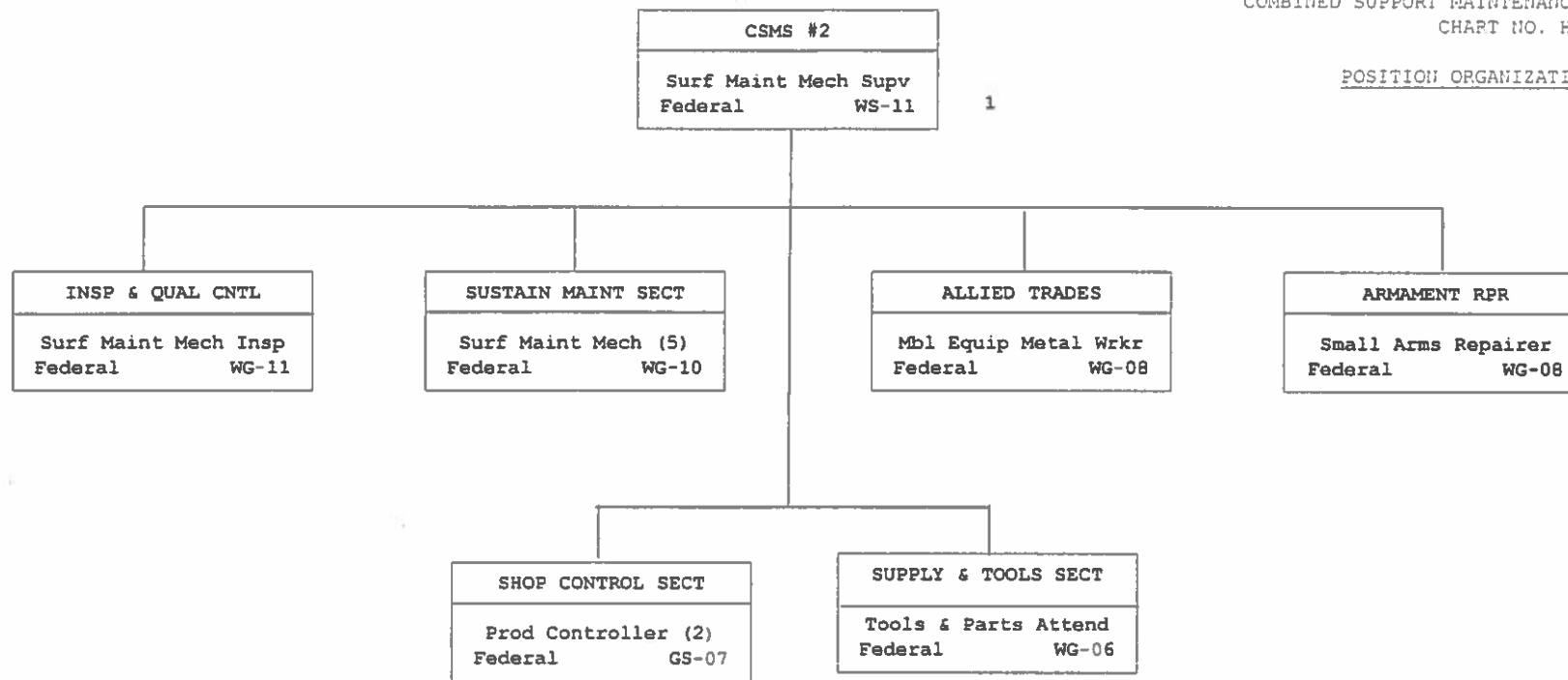

1 All assigned personnel are Federal employees.

ORGANIZATION CHART

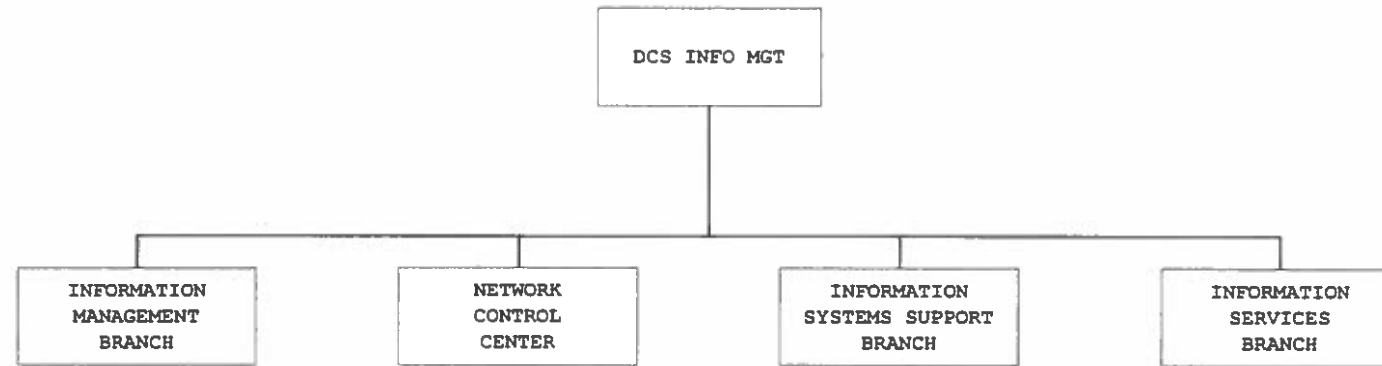

POSITION ORGANIZATION CHART

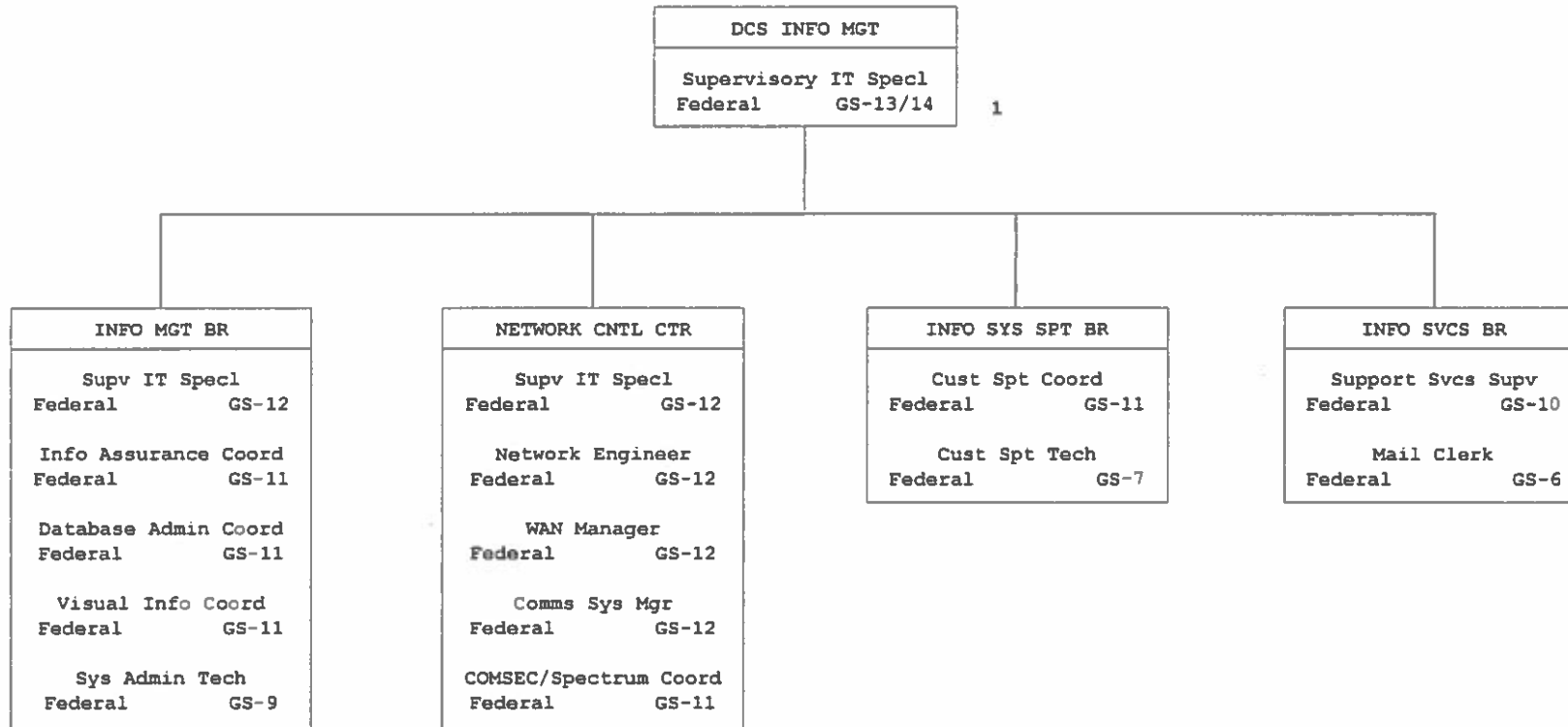

1 All assigned personnel are Federal employees.

ORGANIZATION CHART

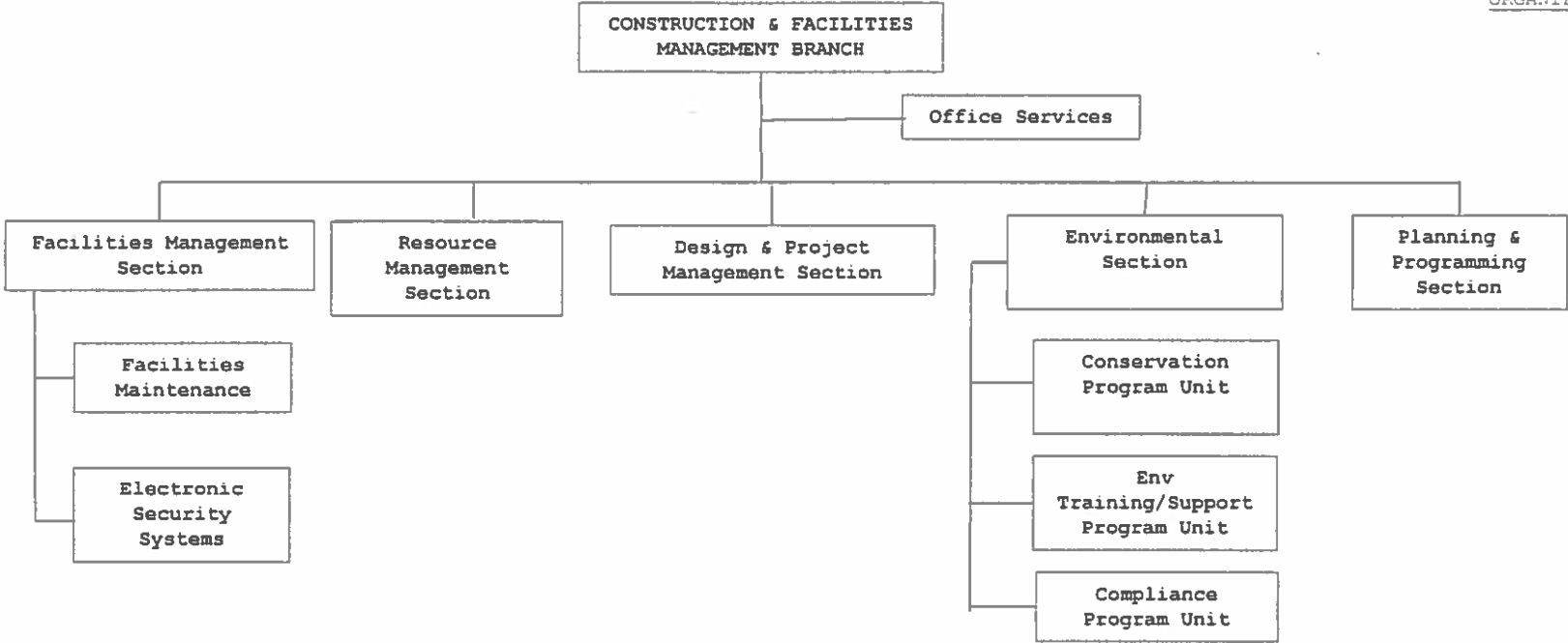

STATE OF HAWAII  
 DEPARTMENT OF DEFENSE  
 ARMY NATIONAL GUARD DIVISION  
 CONSTRUCTION AND FACILITIES MANAGEMENT BRANCH  
 FACILITIES MANAGEMENT SECTION  
 CHART NO. HIARNG 46

POSITION ORGANIZATION CHART

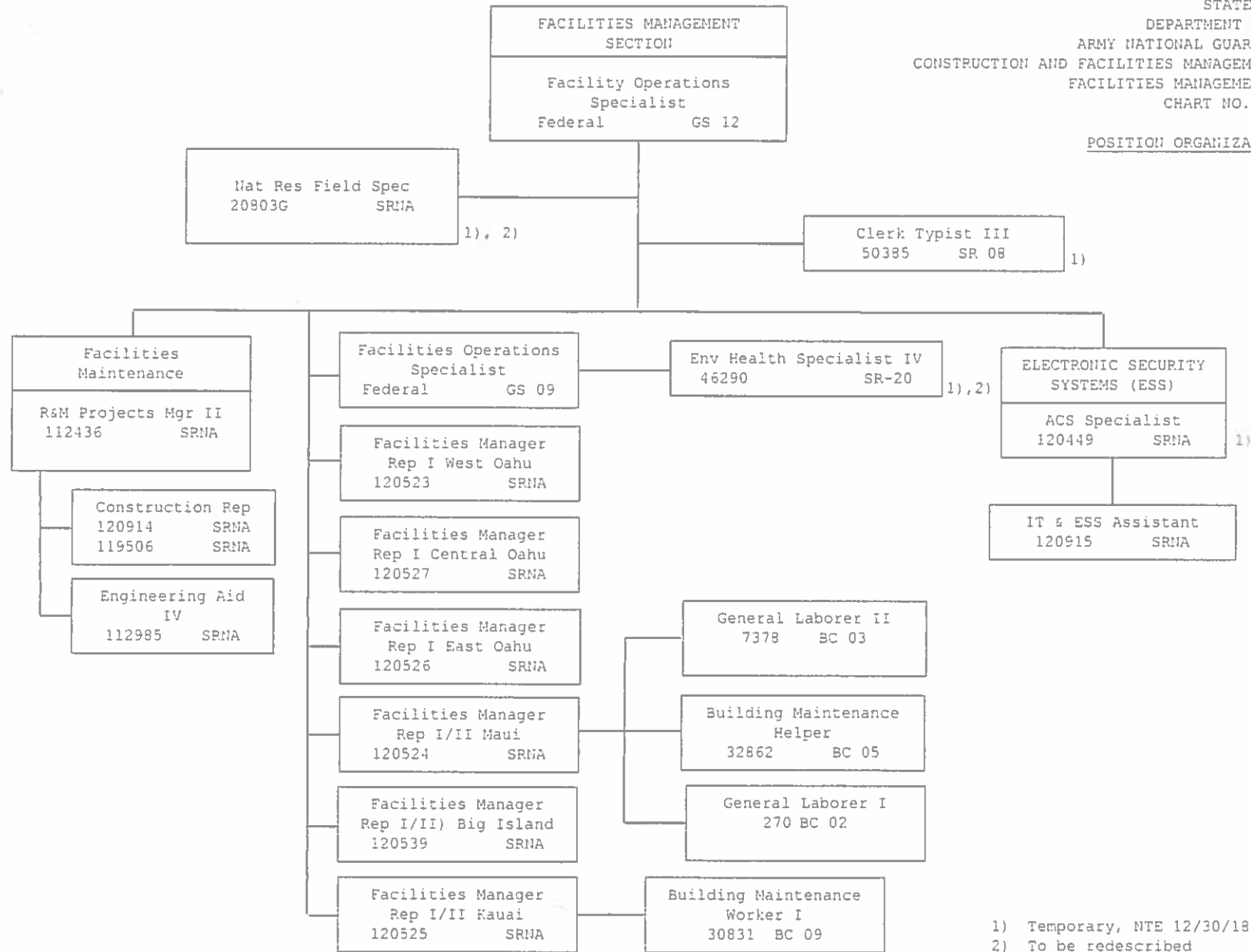

1) Temporary, NTE 12/30/18  
 2) To be redescribed



STATE OF HAWAII  
 DEPARTMENT OF DEFENSE  
 ARMY NATIONAL GUARD DIVISION  
 CONSTRUCTION AND FACILITIES MANAGEMENT BRANCH  
 CHART NO. HIARNG 47

POSITION ORGANIZATION CHART

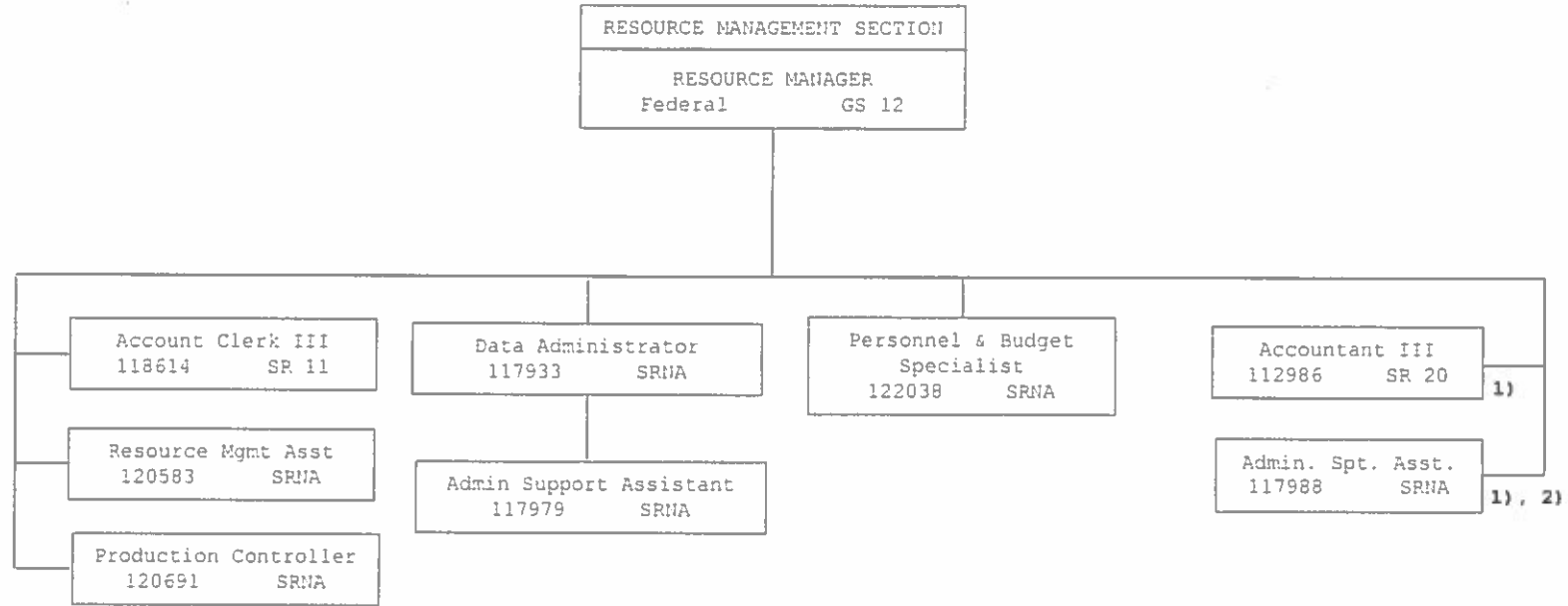

- 1) Funded by CFMB, located in ASO
- 2) Temporary, NTE 4/30/19

STATE OF HAWAII  
 DEPARTMENT OF DEFENSE  
 ARMY NATIONAL GUARD DIVISION  
 CONSTRUCTION AND FACILITIES MANAGEMENT BRANCH  
 DESIGN & PROJECT MANAGEMENT SECTION  
 CHART NO. HIARMG 48

POSITION ORGANIZATION CHART

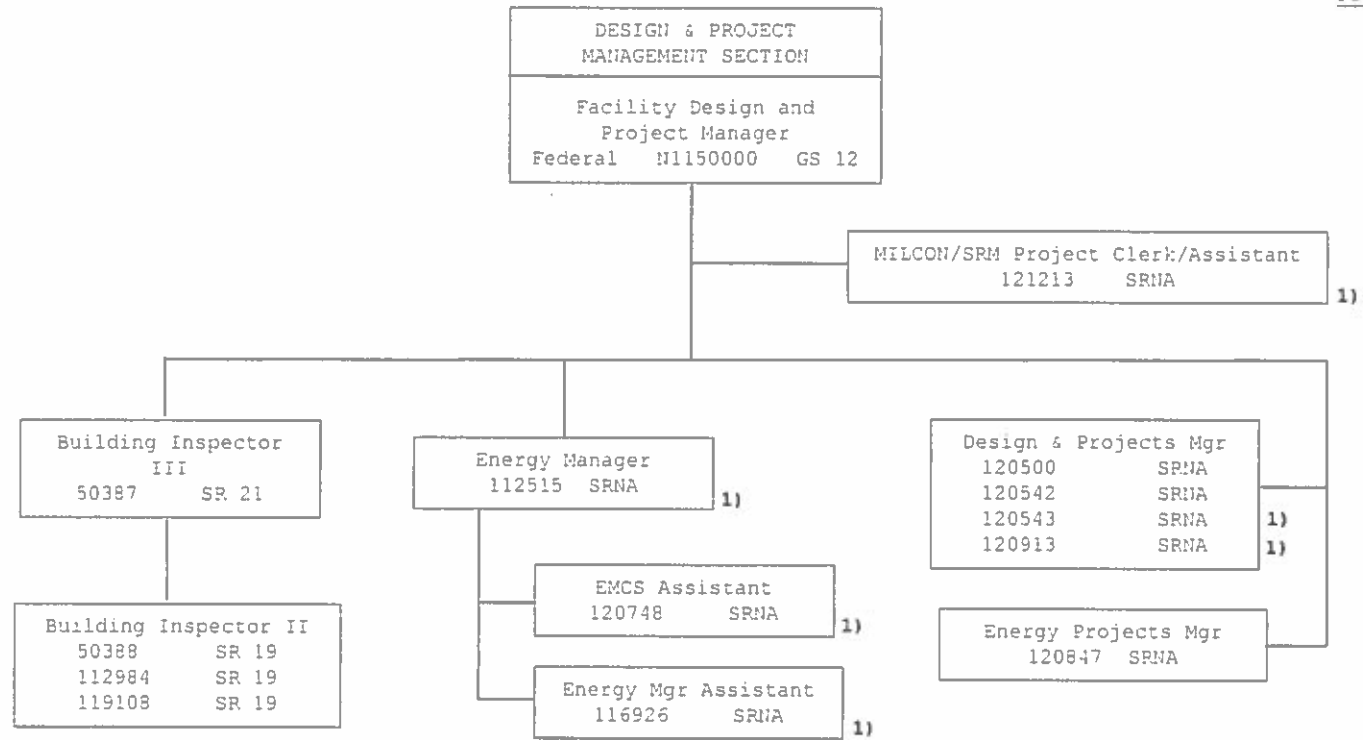

1) Temporary, NTE 12/31/19

POSITION ORGANIZATION CHART

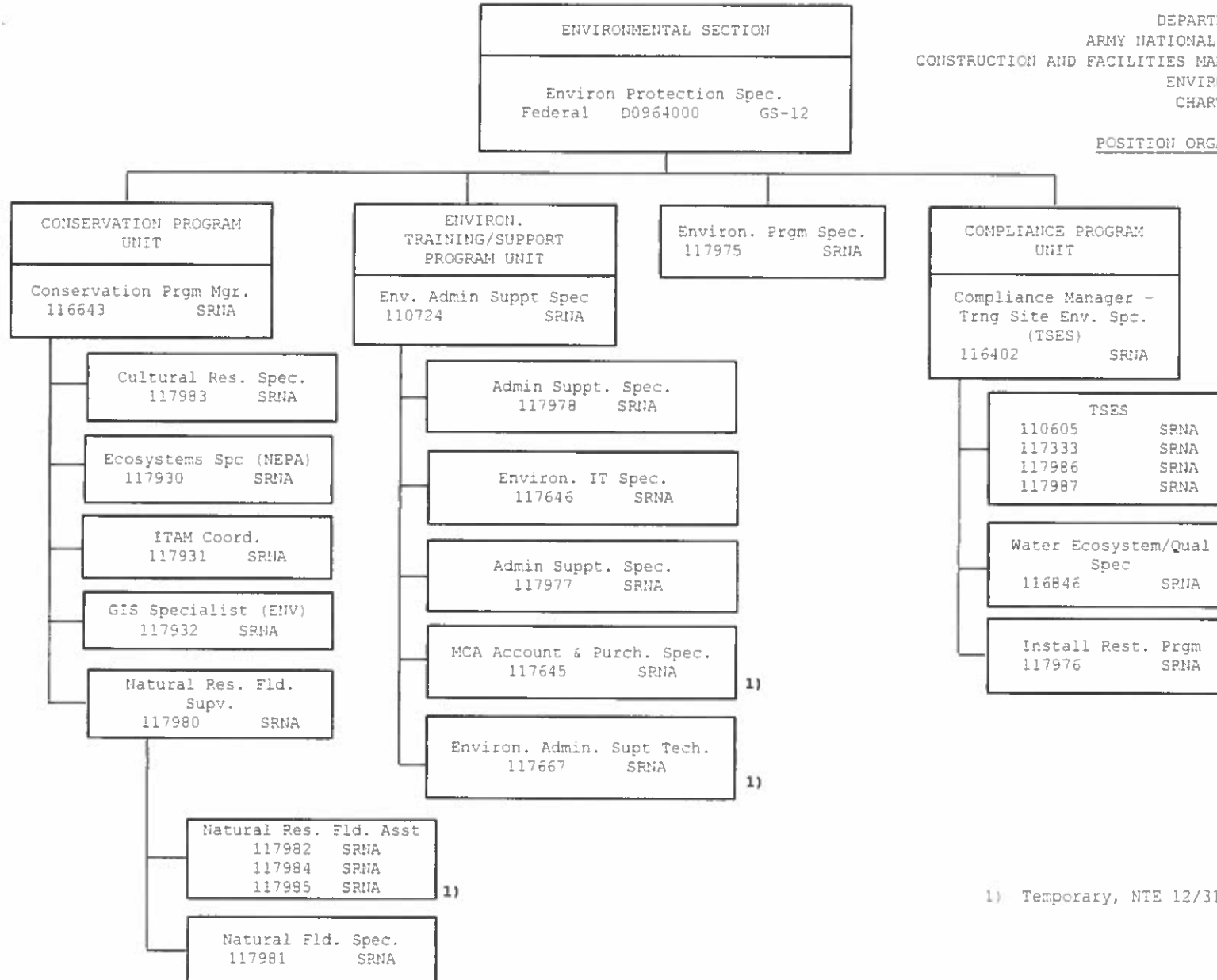

1) Temporary, NTE 12/31/19

STATE OF HAWAII  
 DEPARTMENT OF DEFENSE  
 ARMY NATIONAL GUARD DIVISION  
 CONSTRUCTION AND FACILITIES MANAGEMENT BRANCH  
 PLANNING & PROGRAMMING SECTION  
 CHART NO. HIARNG 50

POSITION ORGANIZATION CHART

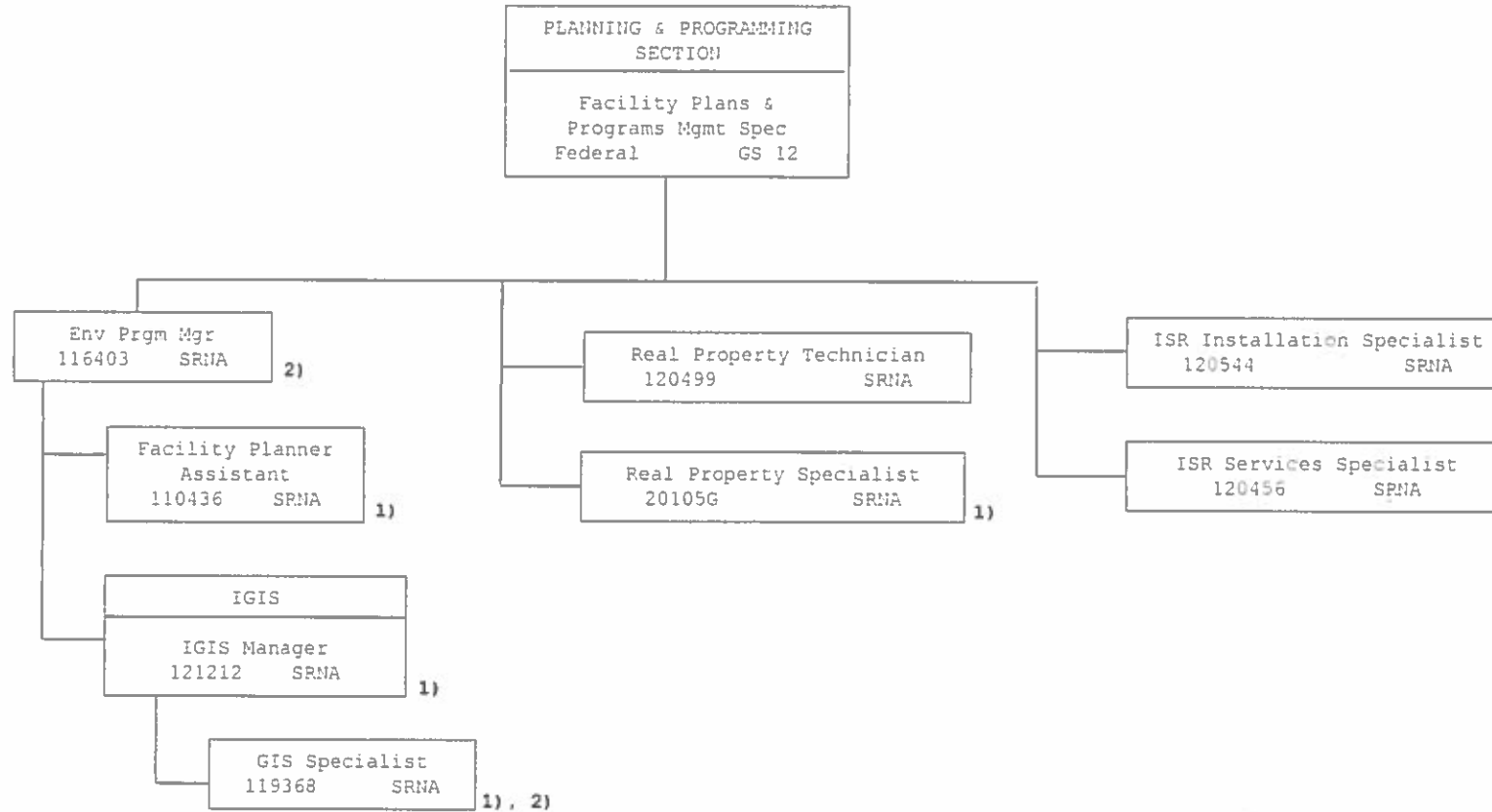

1) Temporary, NTE 4/30/19  
 2) To be redescribed

STATE OF HAWAII  
DEPARTMENT OF DEFENSE  
ARMY NATIONAL GUARD DIVISION  
STATE ARMY AVIATION OFFICE  
CHAPT NO. HIARNG 51

ORGANIZATION CHART

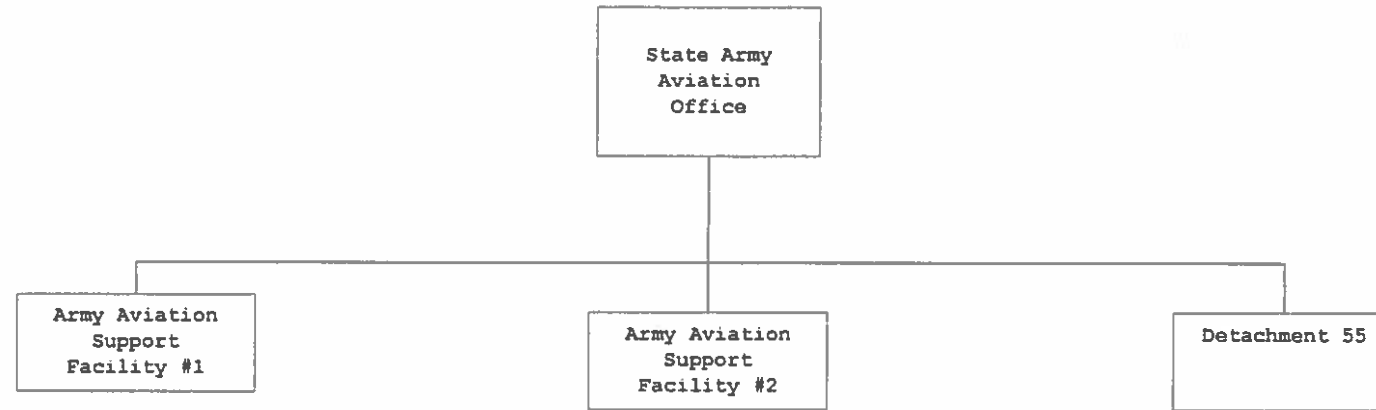

STATE OF HAWAII  
DEPARTMENT OF DEFENSE  
ARMY NATIONAL GUARD DIVISION  
STATE ARMY AVIATION OFFICE  
CHART NO. HIARNG 52

POSITION ORGANIZATION CHART

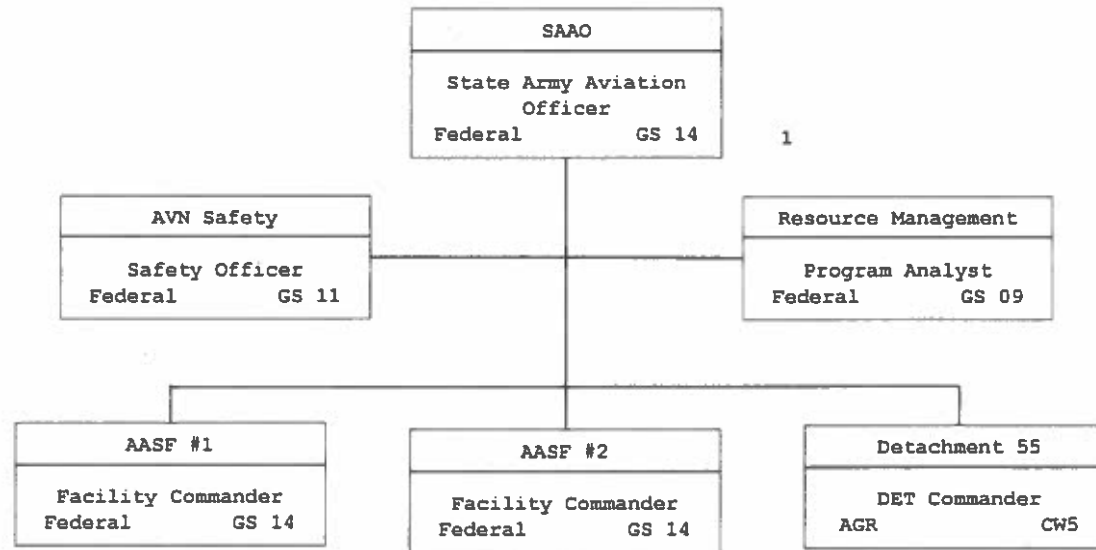

1 All assigned personnel are Federal employees.

POSITION ORGANIZATION CHART

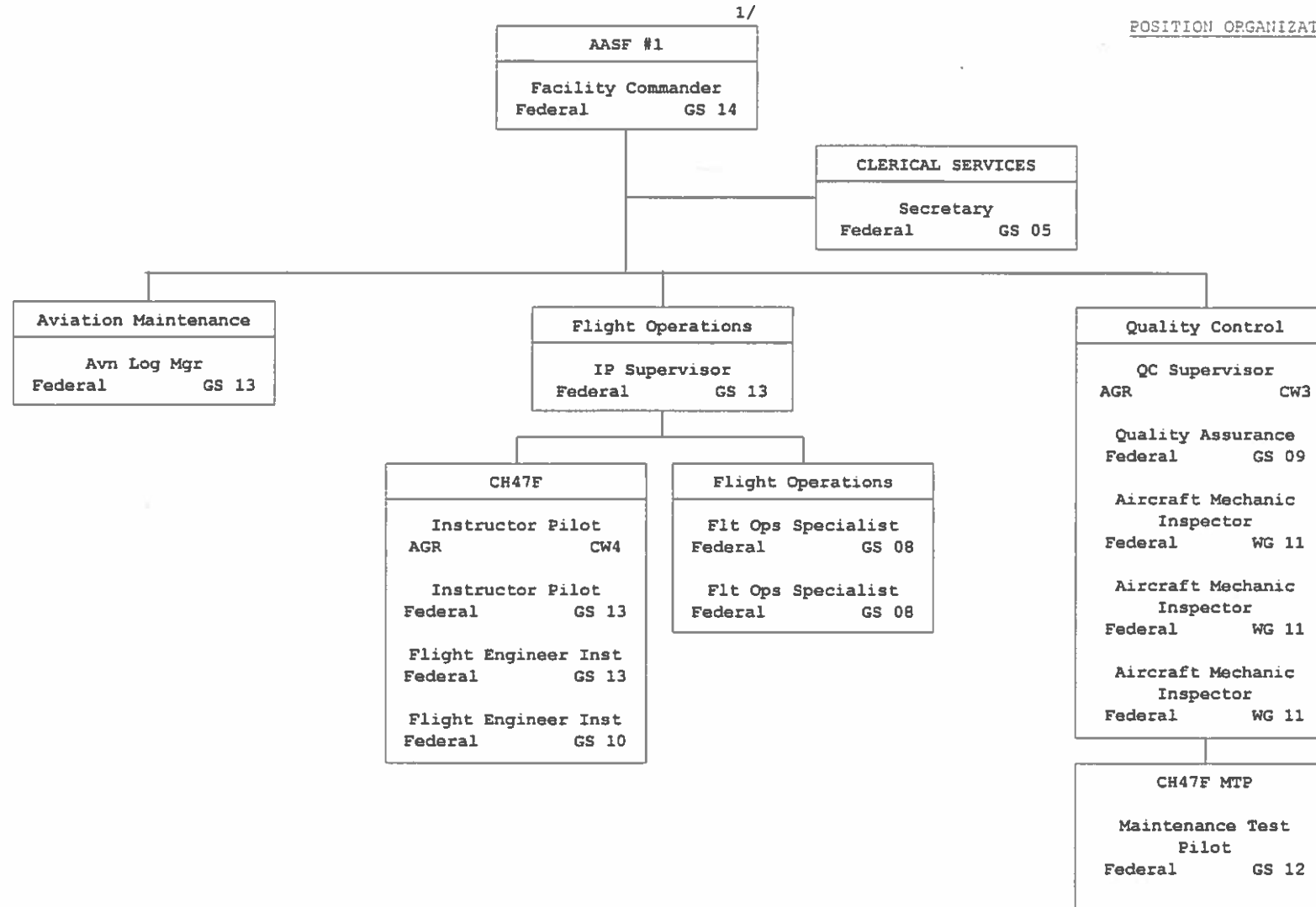

1 All assigned personnel are Federal employees.

POSITION ORGANIZATION CHART

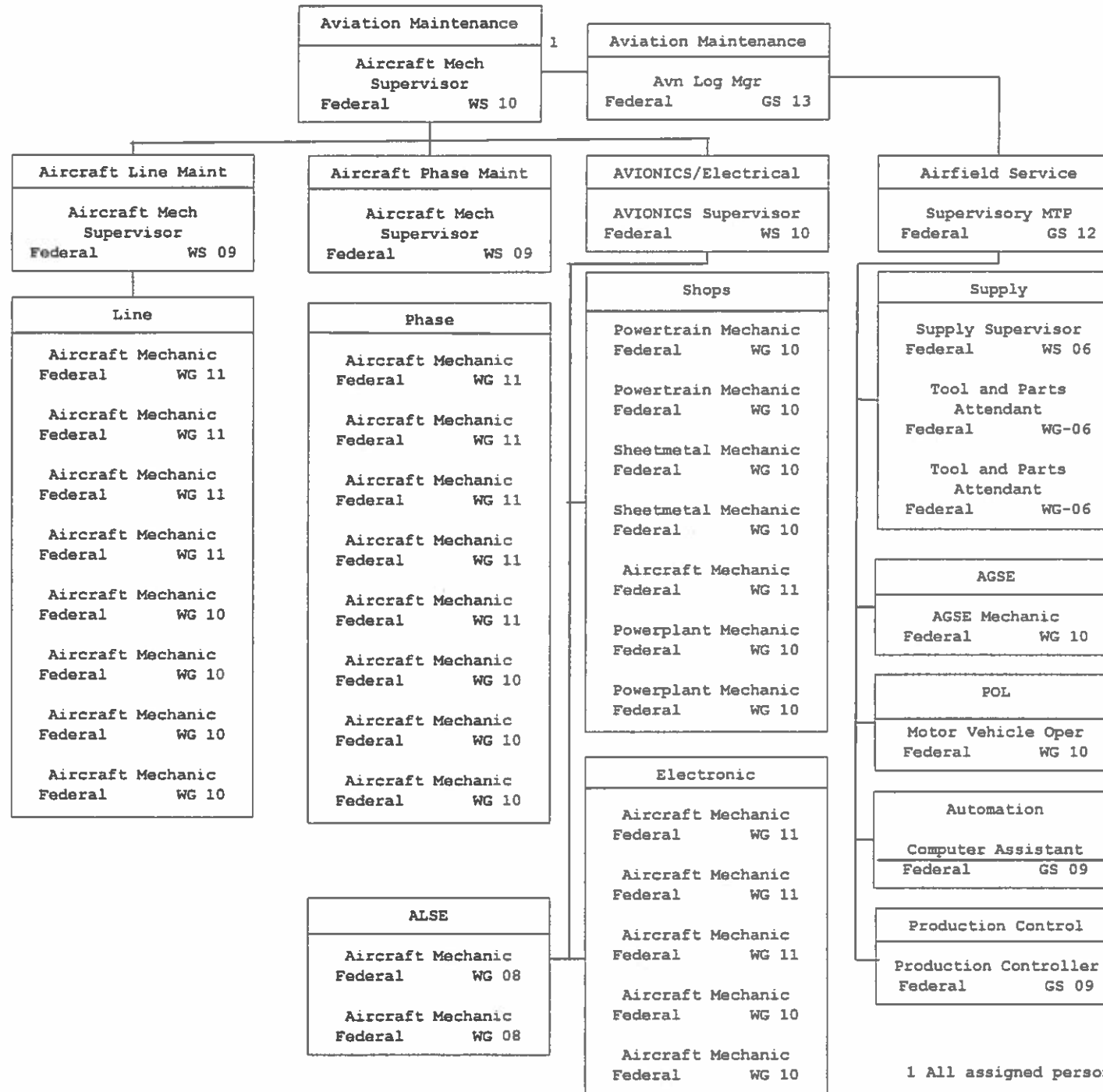

1 All assigned personnel are Federal employees.



POSITION ORGANIZATION CHART

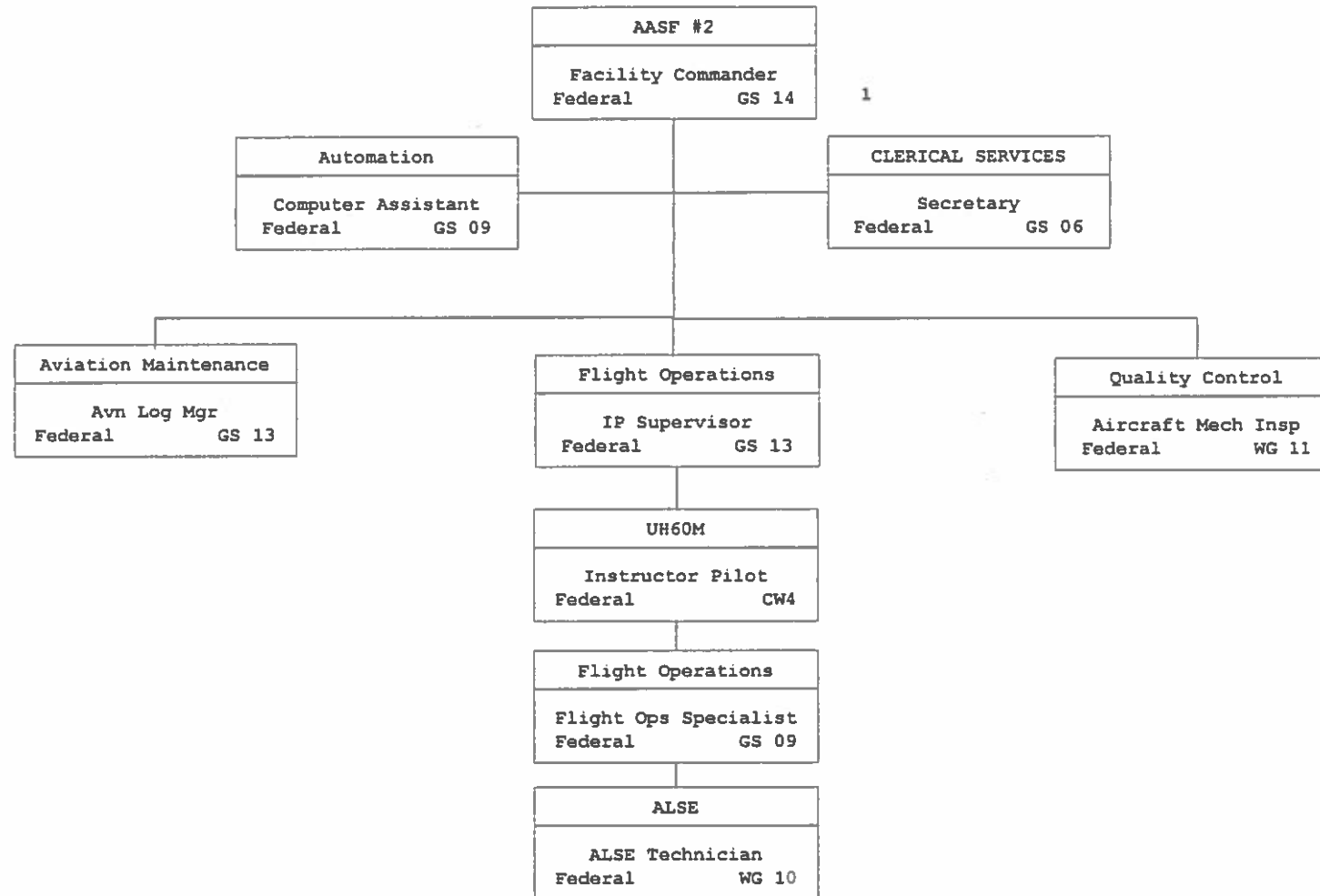

1 All assigned personnel are Federal employees.

STATE OF HAWAII  
 DEPARTMENT OF DEFENSE  
 ARMY NATIONAL GUARD DIVISION  
 ARMY AVIATION SUPPORT FACILITY #2  
 STATE ARMY AVIATION OFFICE  
 AVIATION MAINTENANCE  
 CHART NO. HIARNG 56

POSITION ORGANIZATION CHART

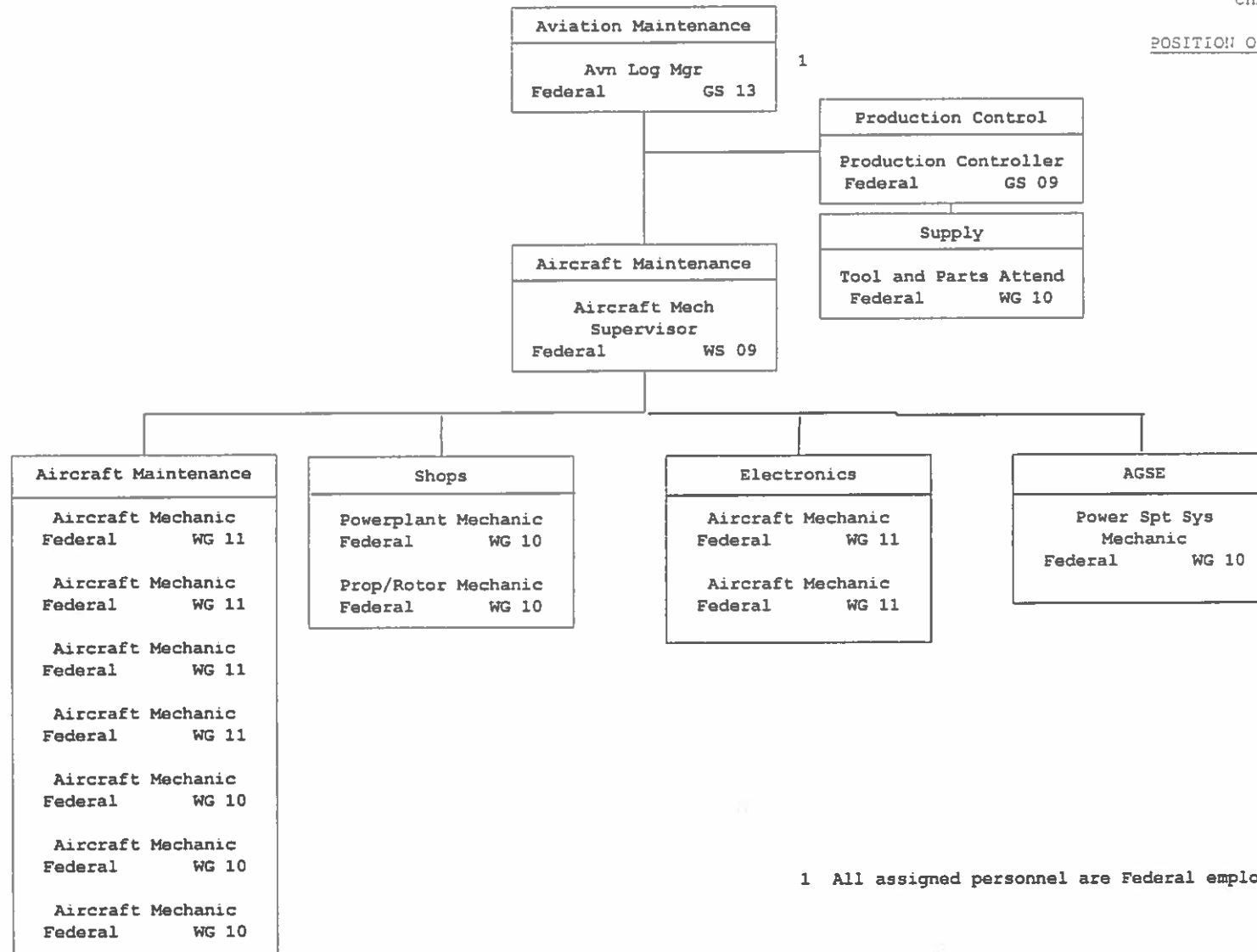

1 All assigned personnel are Federal employees.

STATE OF HAWAII  
DEPARTMENT OF DEFENSE  
ARMY NATIONAL GUARD DIVISION  
STATE ARMY AVIATION OFFICE  
DETACHMENT 55 OSACCM  
CHART NO. HIARNG 57

POSITION ORGANIZATION CHART

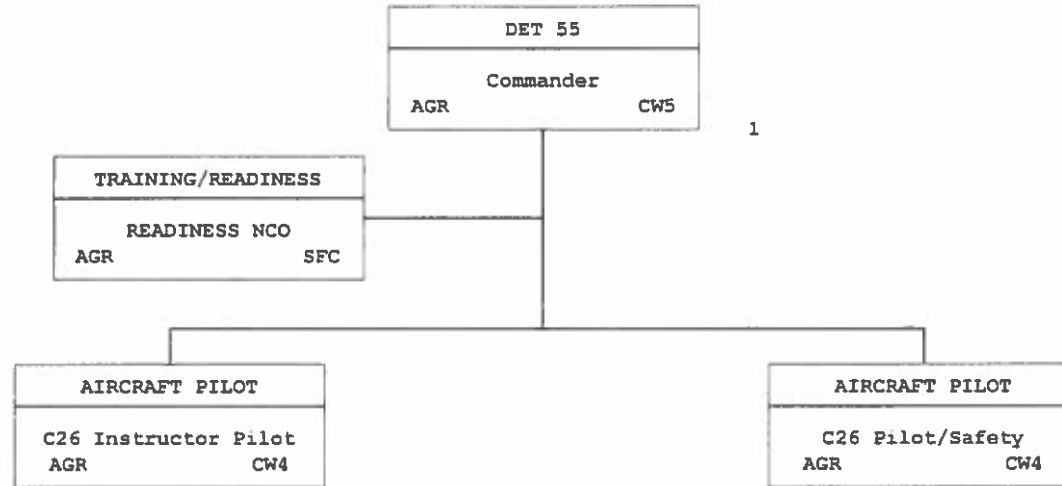

1 All assigned personnel are Federal employees.

STATE OF HAWAII  
DEPARTMENT OF DEFENSE  
ARMY NATIONAL GUARD DIVISION  
RECRUITING AND RETENTION BATTALION  
CHART NO. HIARNG 58

ORGANIZATION CHART

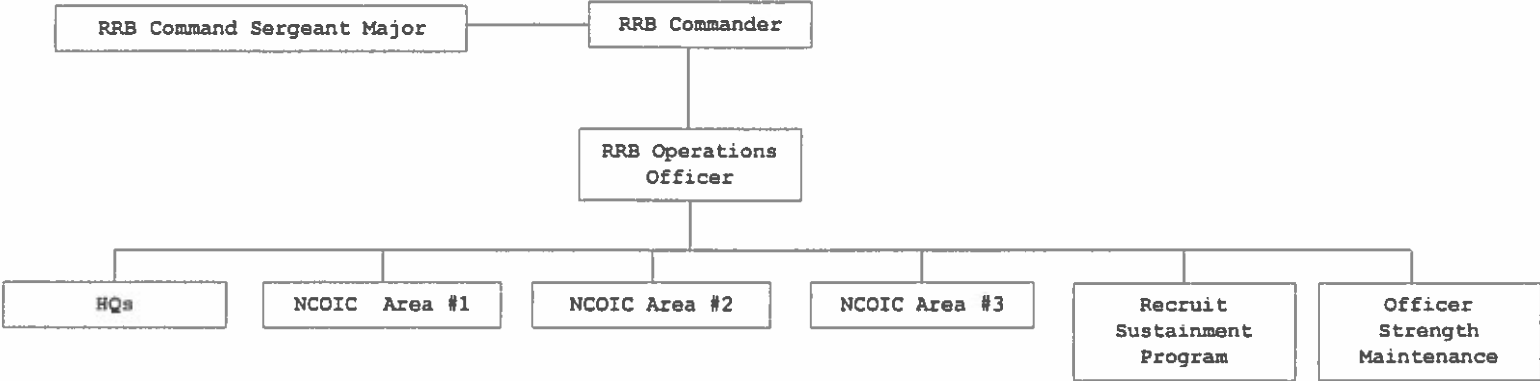

ORGANIZATION CHART

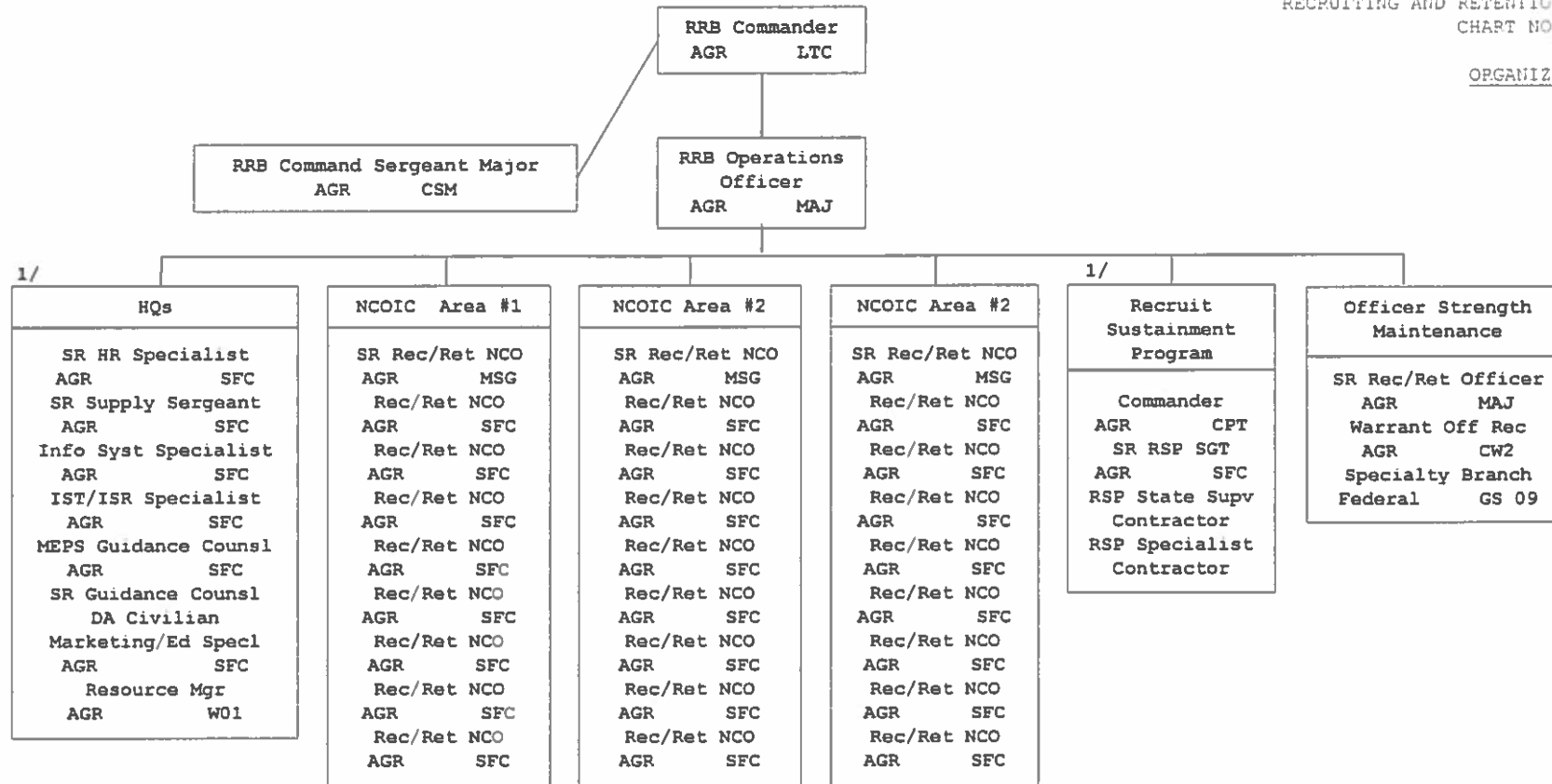

Notes:

1/ Contract staff and DA Civilian funded directly by the National Guard Bureau.  
 All assigned personnel are Federal employees.

STATE OF HAWAII  
DEPARTMENT OF DEFENSE  
ARMY NATIONAL GUARD DIVISION  
OFFICE OF THE STATE SURGEON  
MEDICAL DETACHMENT  
CHART NO. HIARNG 60

ORGANIZATION CHART

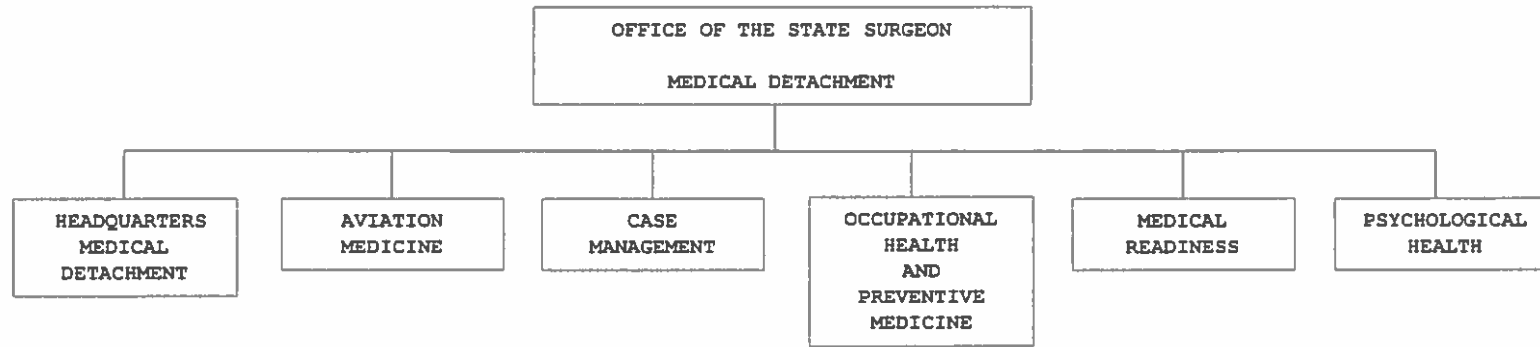

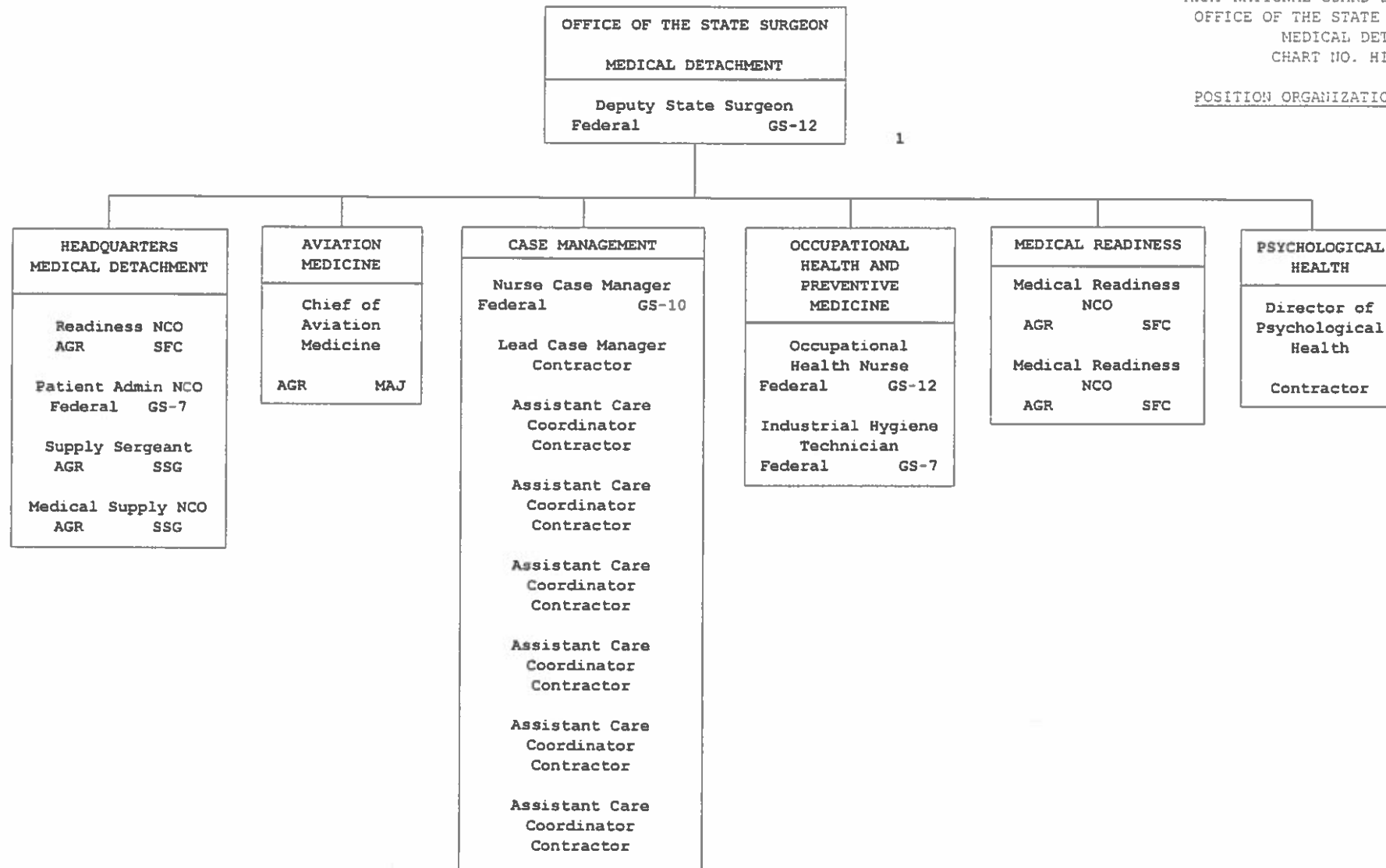

1 All assigned personnel are Federal employees.

STATE OF HAWAII  
DEPARTMENT OF DEFENSE  
ARMY NATIONAL GUARD DIVISION  
29<sup>th</sup> INFANTRY BRIGADE COMBAT TEAM  
CHART NO. HIARNG 62

ORGANIZATION CHART

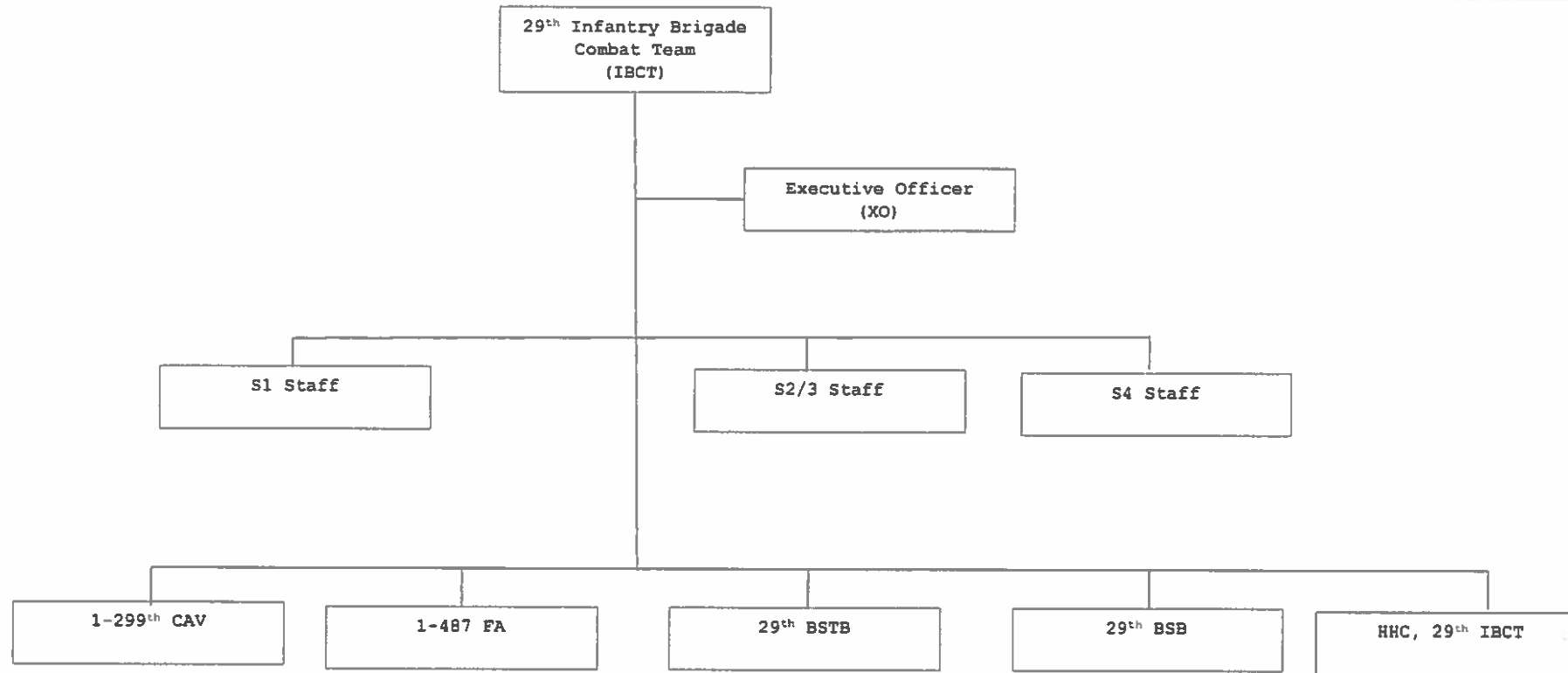



STATE OF HAWAII  
 DEPARTMENT OF DEFENSE  
 ARMY NATIONAL GUARD DIVISION  
 29<sup>th</sup> INFANTRY BRIGADE COMBAT TEAM  
 CHART NO. HIARNG 63

POSITION ORGANIZATION CHART

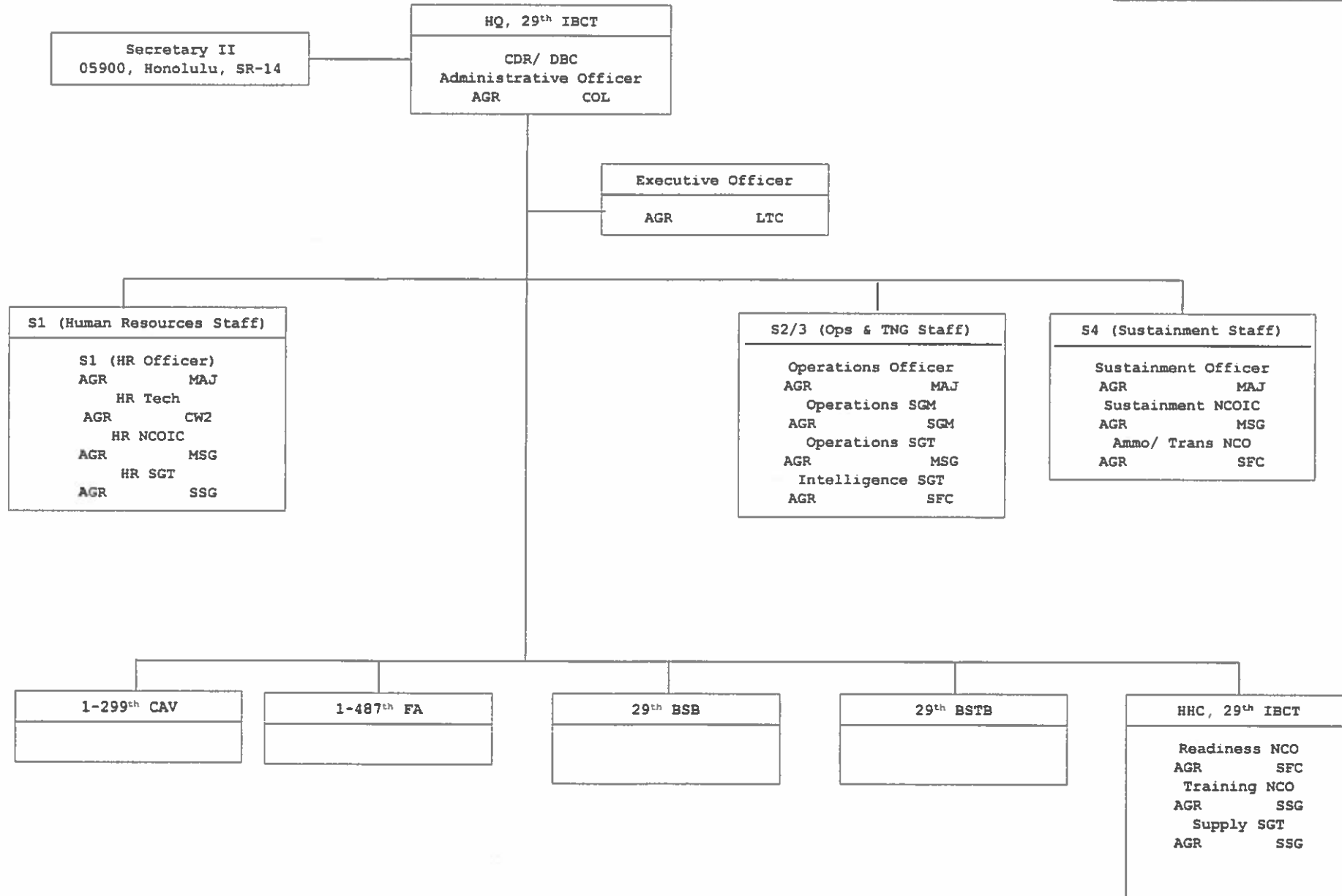

STATE OF HAWAII  
DEPARTMENT OF DEFENSE  
ARMY NATIONAL GUARD DIVISION  
29<sup>TH</sup> INFANTRY BRIGADE COMBAT TEAM  
1<sup>ST</sup> SQUADRON, 299<sup>TH</sup> CAVALRY  
CHART NO. HIARNG 64

ORGANIZATION CHART

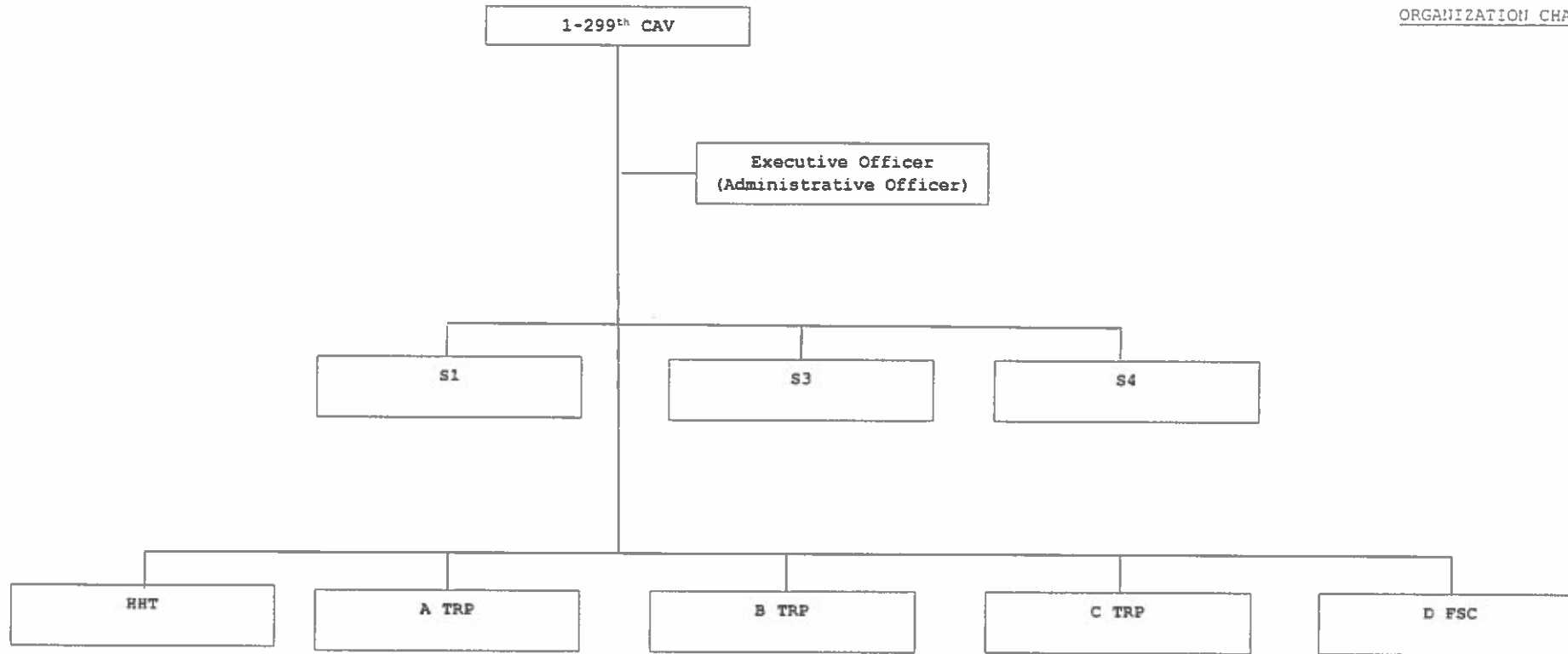

POSITION ORGANIZATION CHART

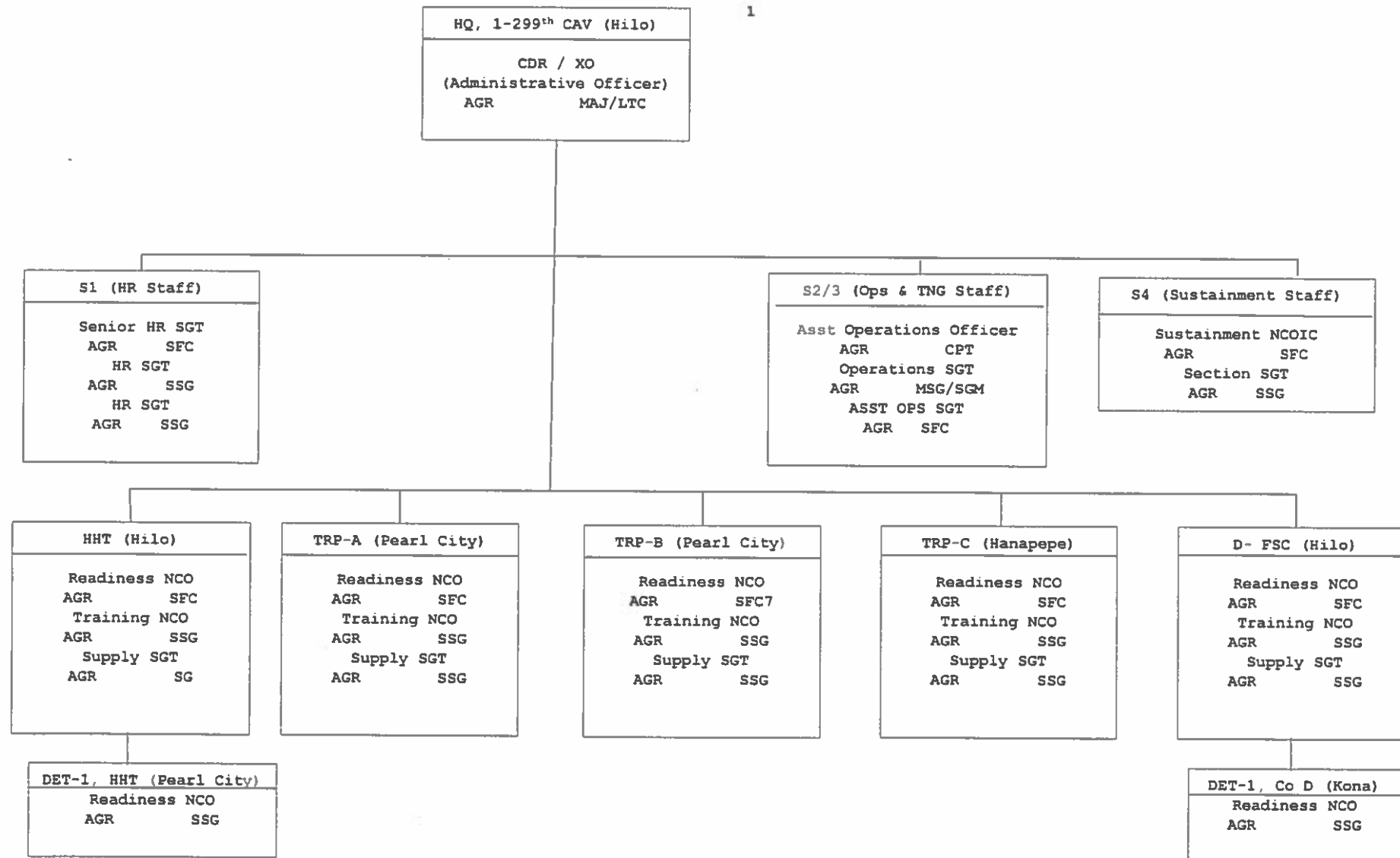

1 All assigned personnel are Federal employees.

STATE OF HAWAII  
DEPARTMENT OF DEFENSE  
ARMY NATIONAL GUARD DIVISION  
29<sup>th</sup> INFANTRY BRIGADE COMBAT TEAM  
1<sup>st</sup> BATTALION, 487<sup>th</sup> FIELD ARTILLERY  
CHART NO. HIARNG 66

ORGANIZATION CHART

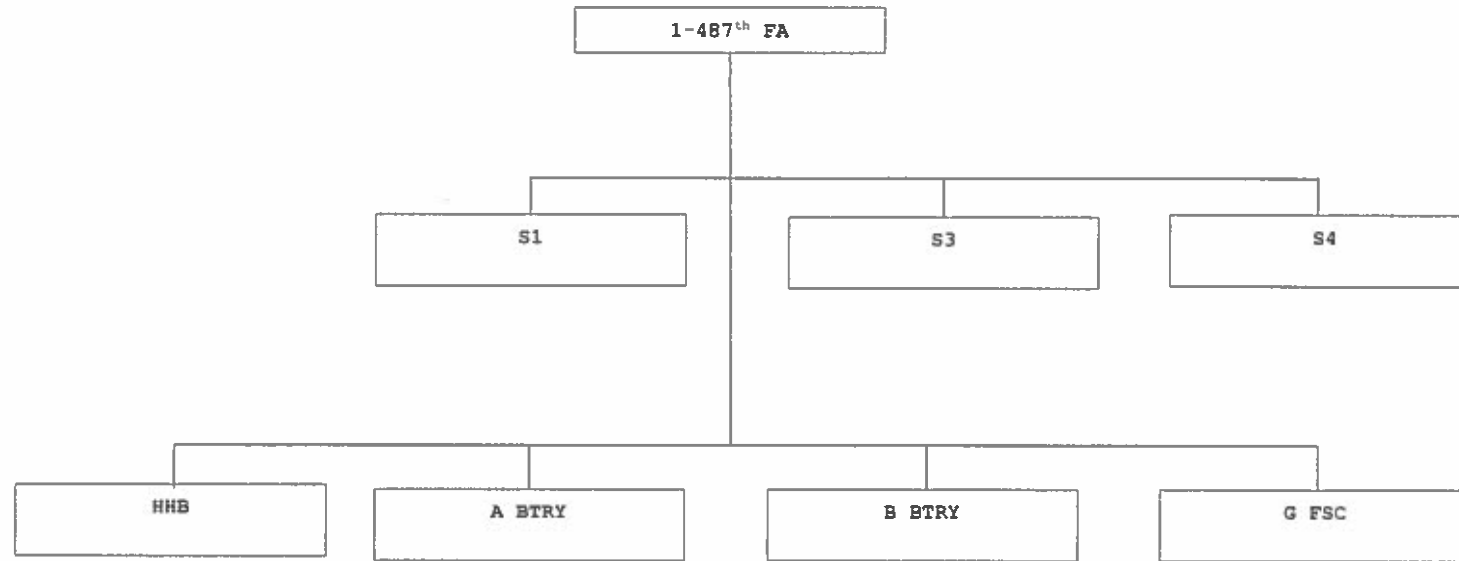

POSITION ORGANIZATION CHART

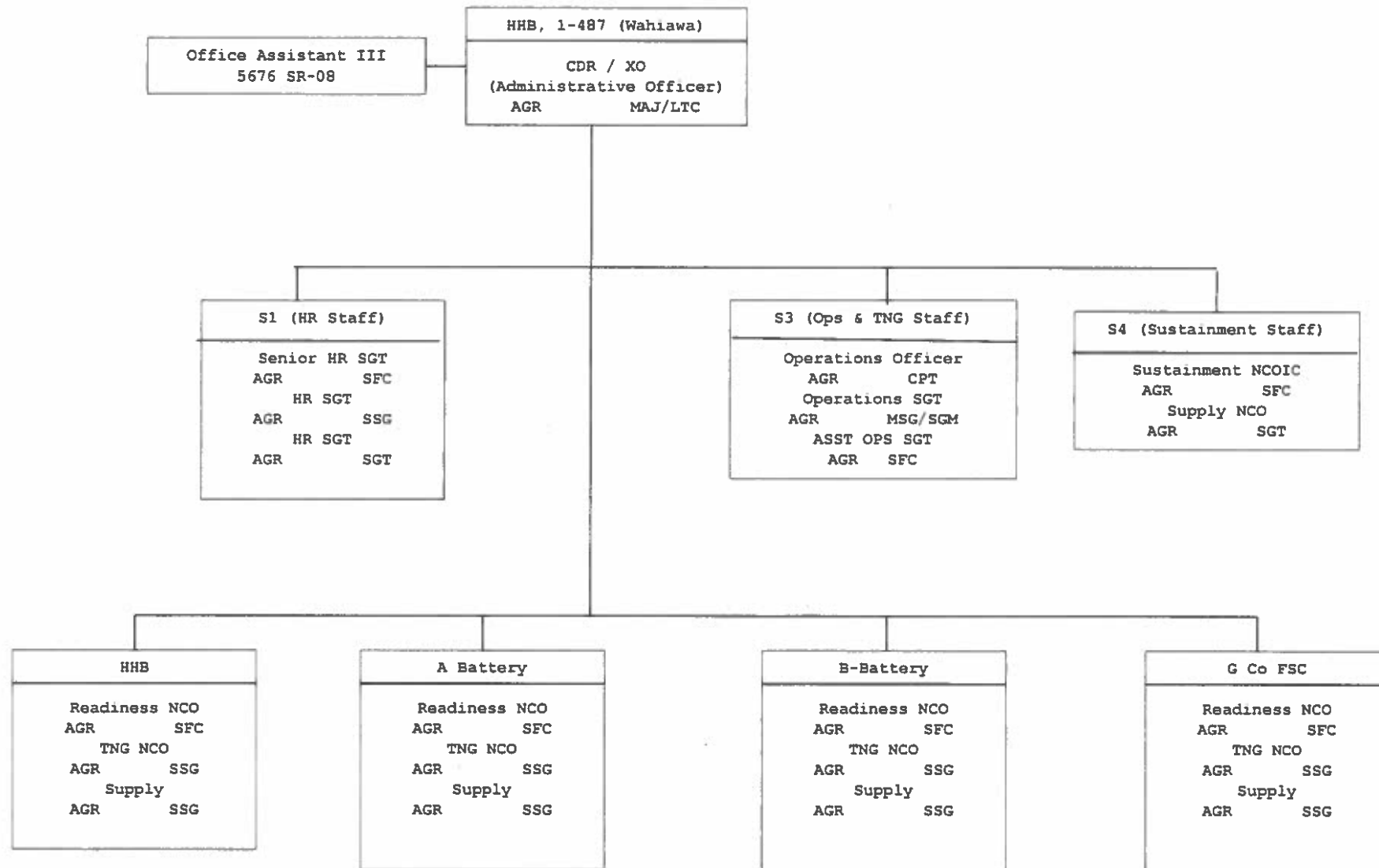

STATE OF HAWAII  
DEPARTMENT OF DEFENSE  
ARMY NATIONAL GUARD DIVISION  
29<sup>th</sup> INFANTRY BRIGADE COMBAT TEAM  
29<sup>th</sup> BRIGADE SUPPORT BATTALION  
CHART NO. HIARNG 68

ORGANIZATION CHART

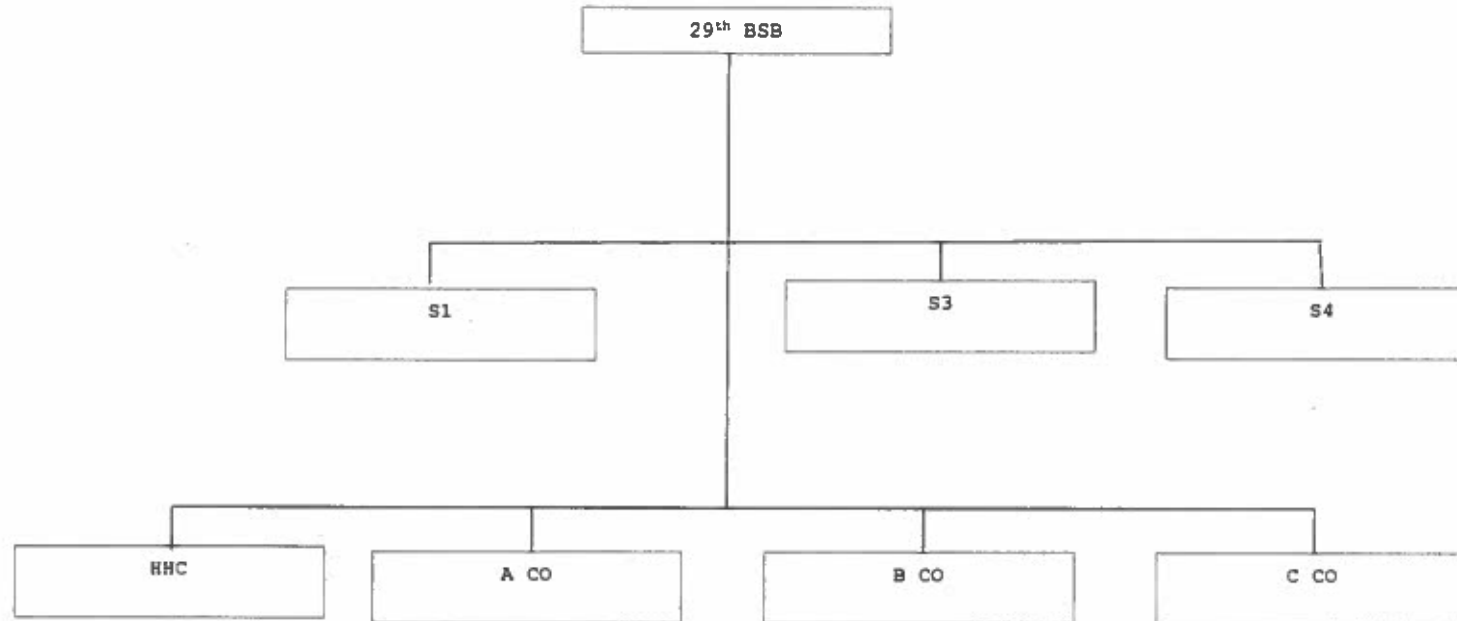

POSITION ORGANIZATION CHART

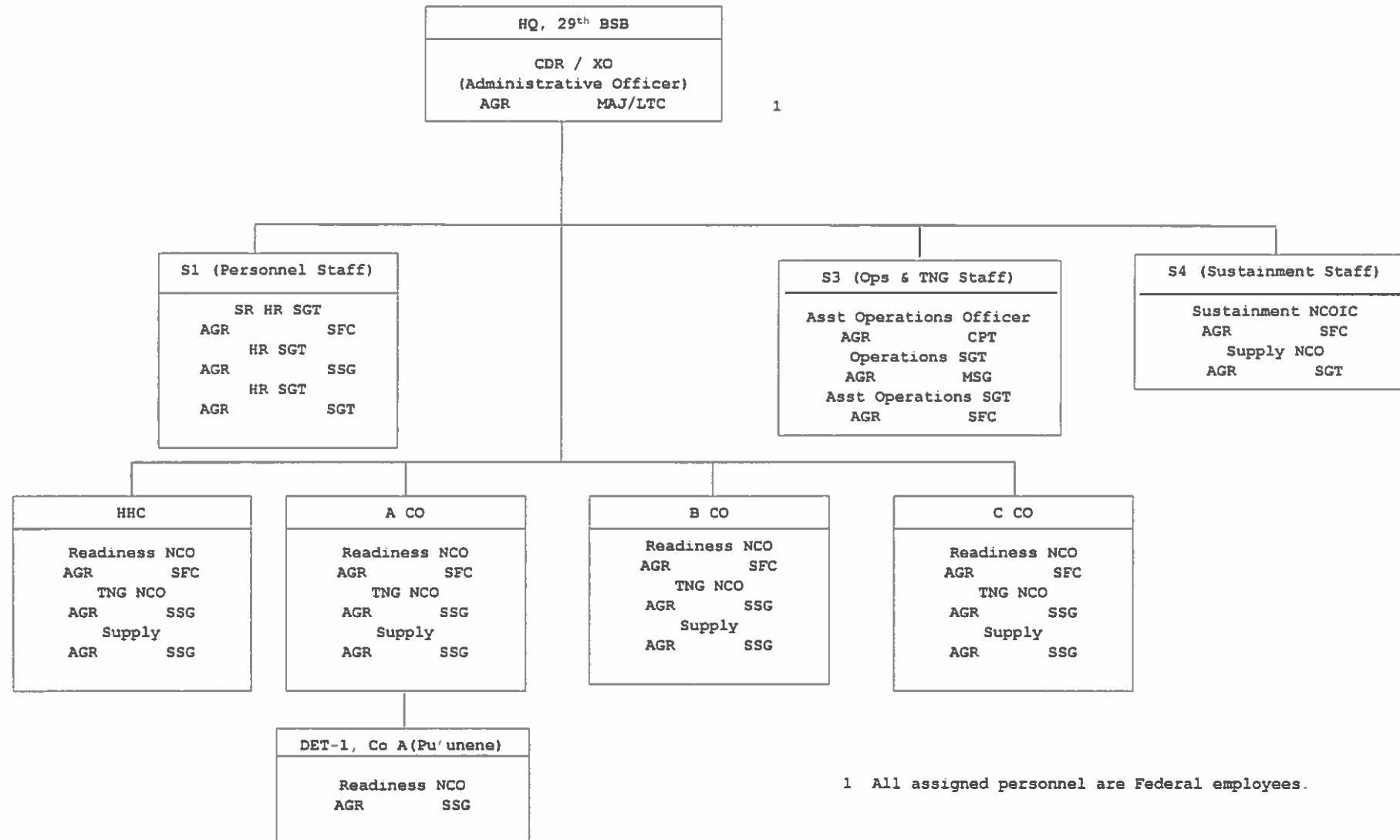

1 All assigned personnel are Federal employees.

STATE OF HAWAII  
DEPARTMENT OF DEFENSE  
ARMY NATIONAL GUARD DIVISION  
29<sup>th</sup> INFANTRY BRIGADE COMBAT TEAM  
29<sup>th</sup> BRIGADE SPECIAL TROOPS BATTALION  
CHART NO. HIARNG 70

ORGANIZATION CHART

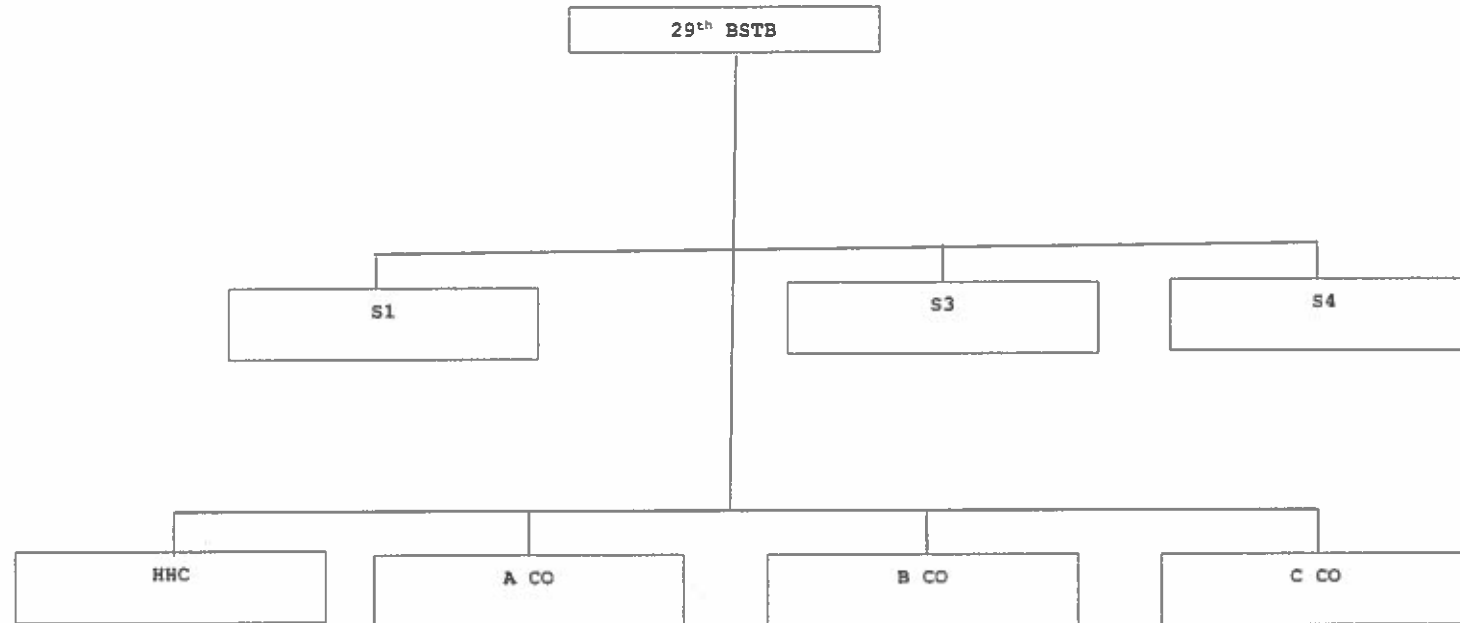



POSITION ORGANIZATION CHART

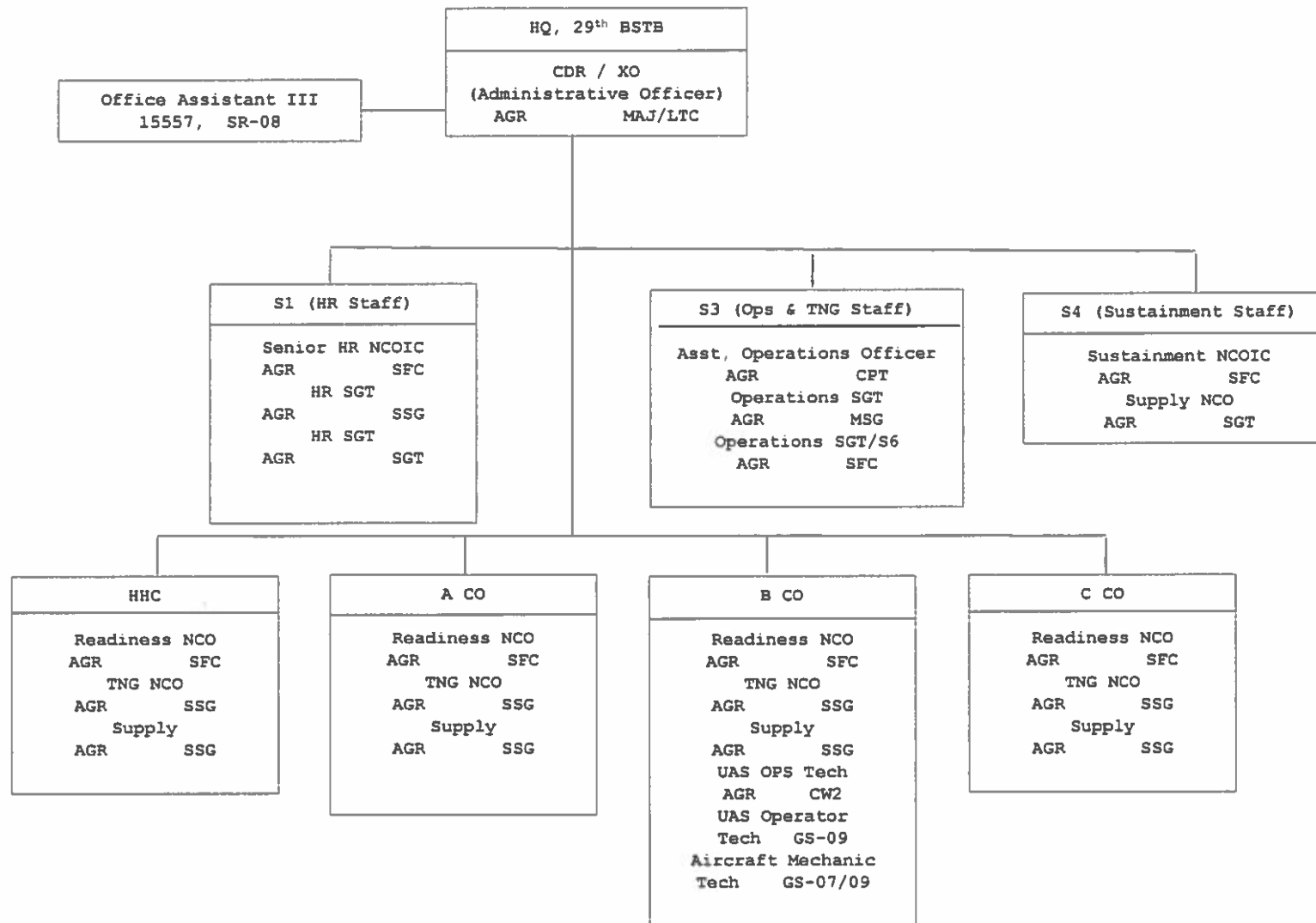

STATE OF HAWAII  
 DEPARTMENT OF DEFENSE  
 ARMY NATIONAL GUARD DIVISION  
 103<sup>rd</sup> TROOP COMMAND  
 CHART NO. HIARNG 72

ORGANIZATION CHART

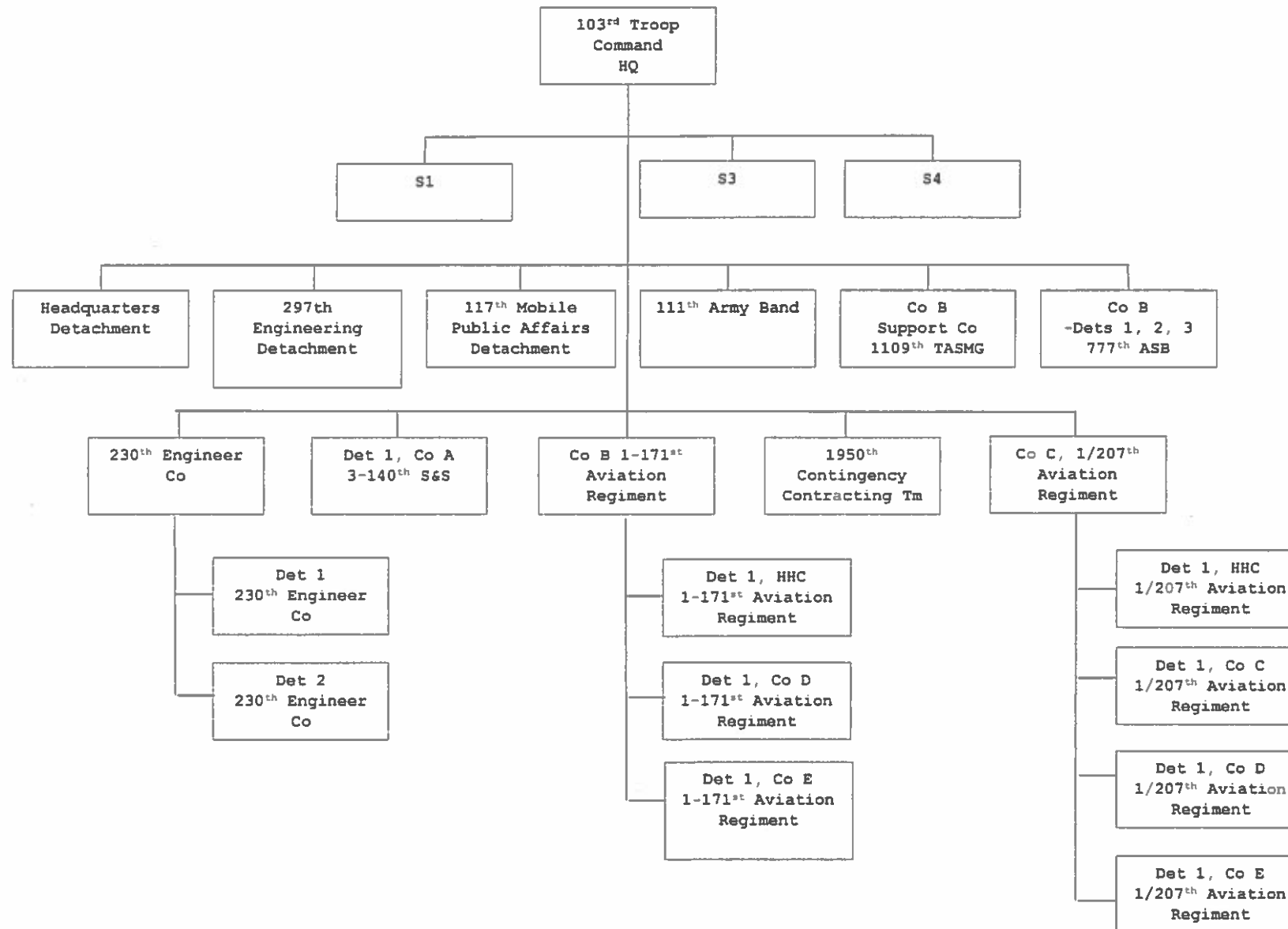

POSITION ORGANIZATION CHART

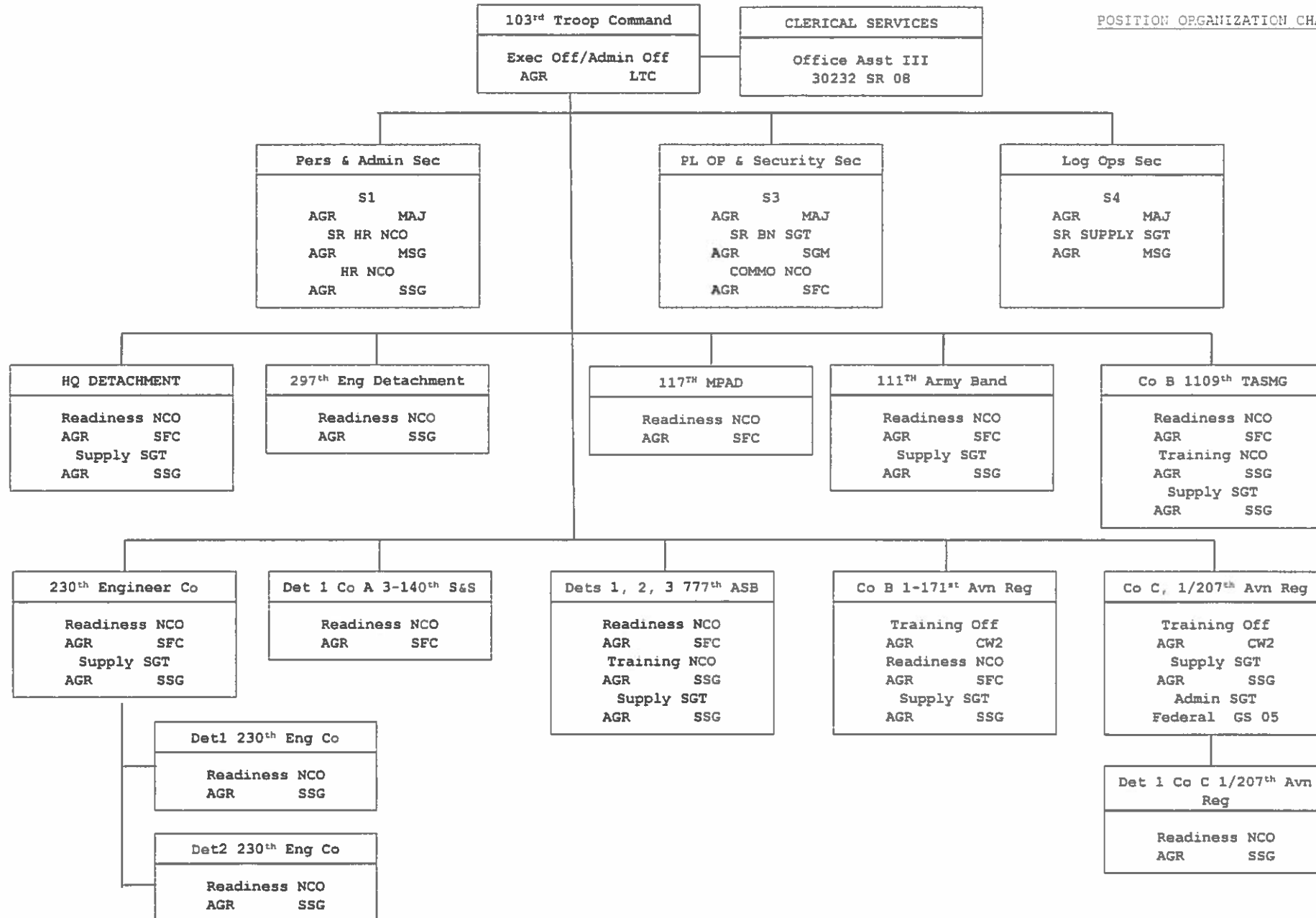

STATE OF HAWAII  
DEPARTMENT OF DEFENSE  
ARMY NATIONAL GUARD DIVISION  
298<sup>TH</sup> REGIMENT, MFTU (RTI)  
CHART NO. HIARNG 74

ORGANIZATION CHART

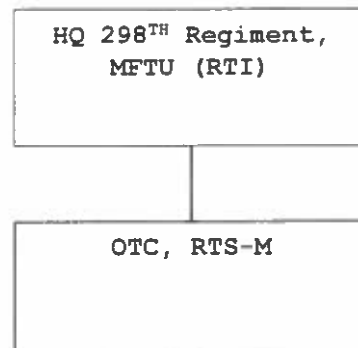

POSITION ORGANIZATION CHART

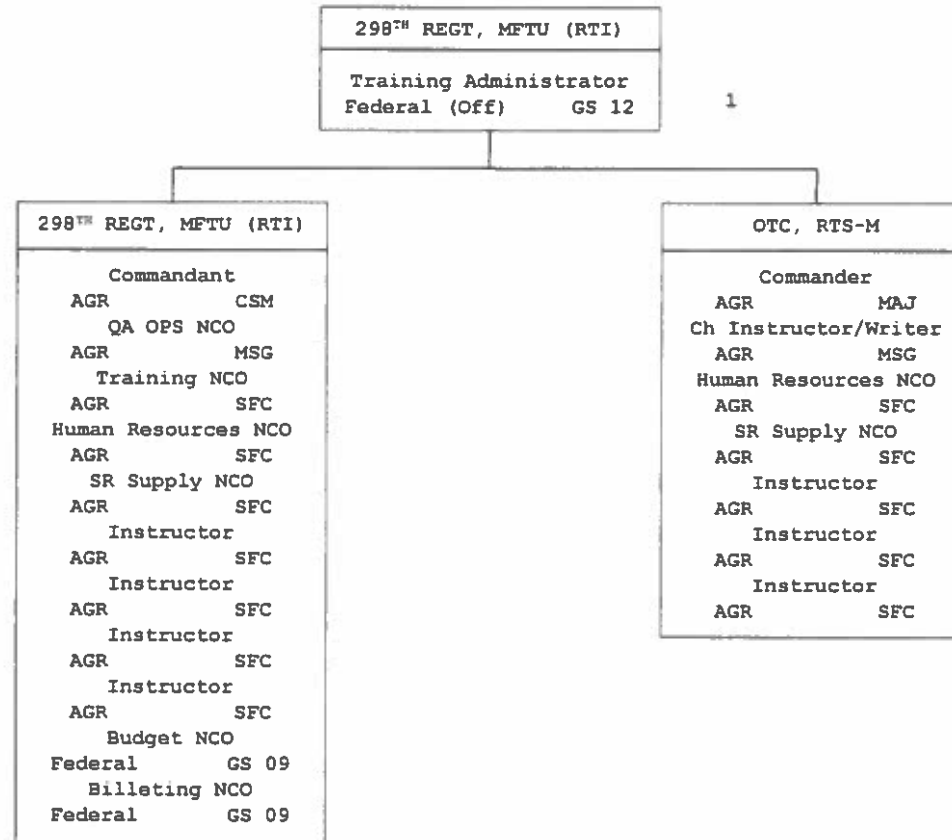

1 All assigned personnel are Federal employees.

ORGANIZATION CHART

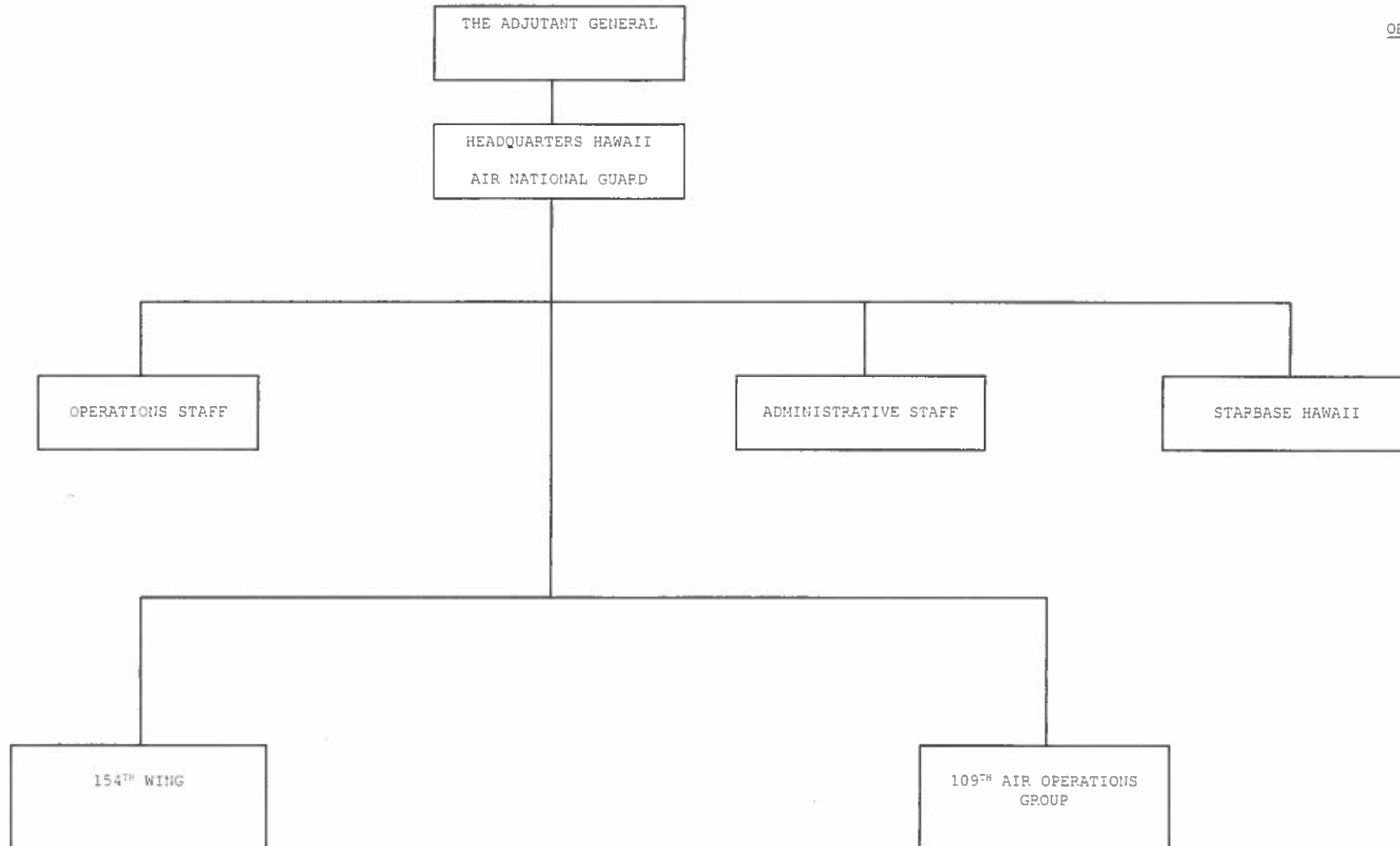

POSITION ORGANIZATION CHART

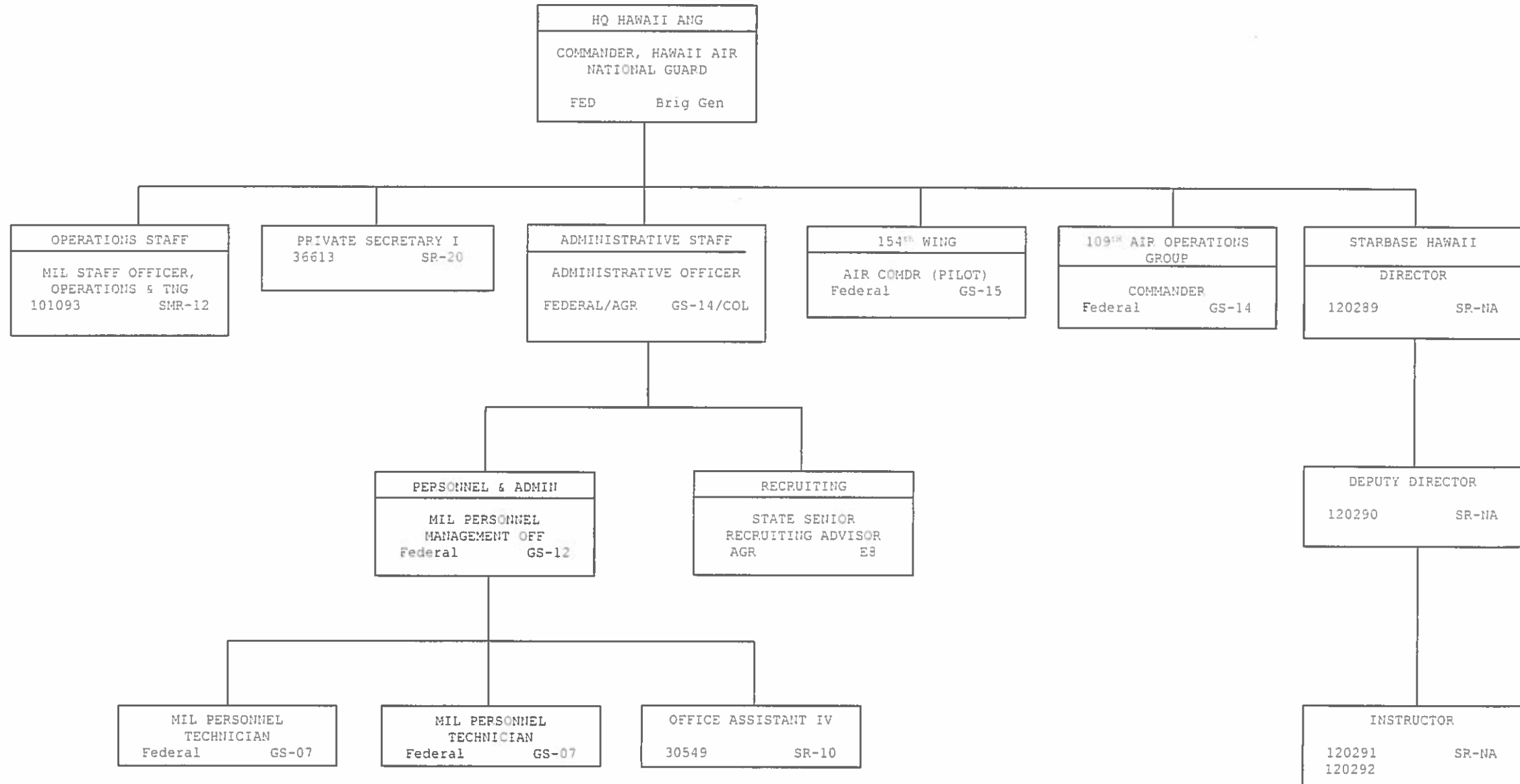

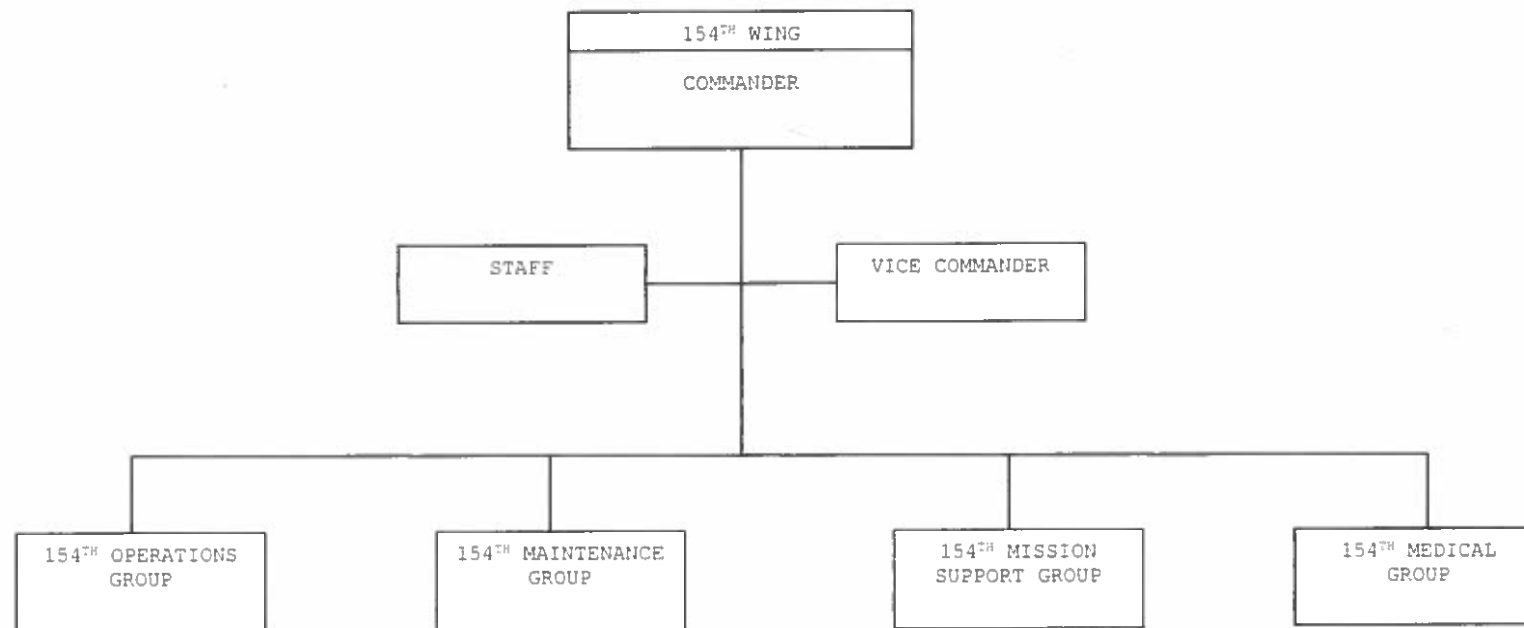



POSITION ORGANIZATION CHART

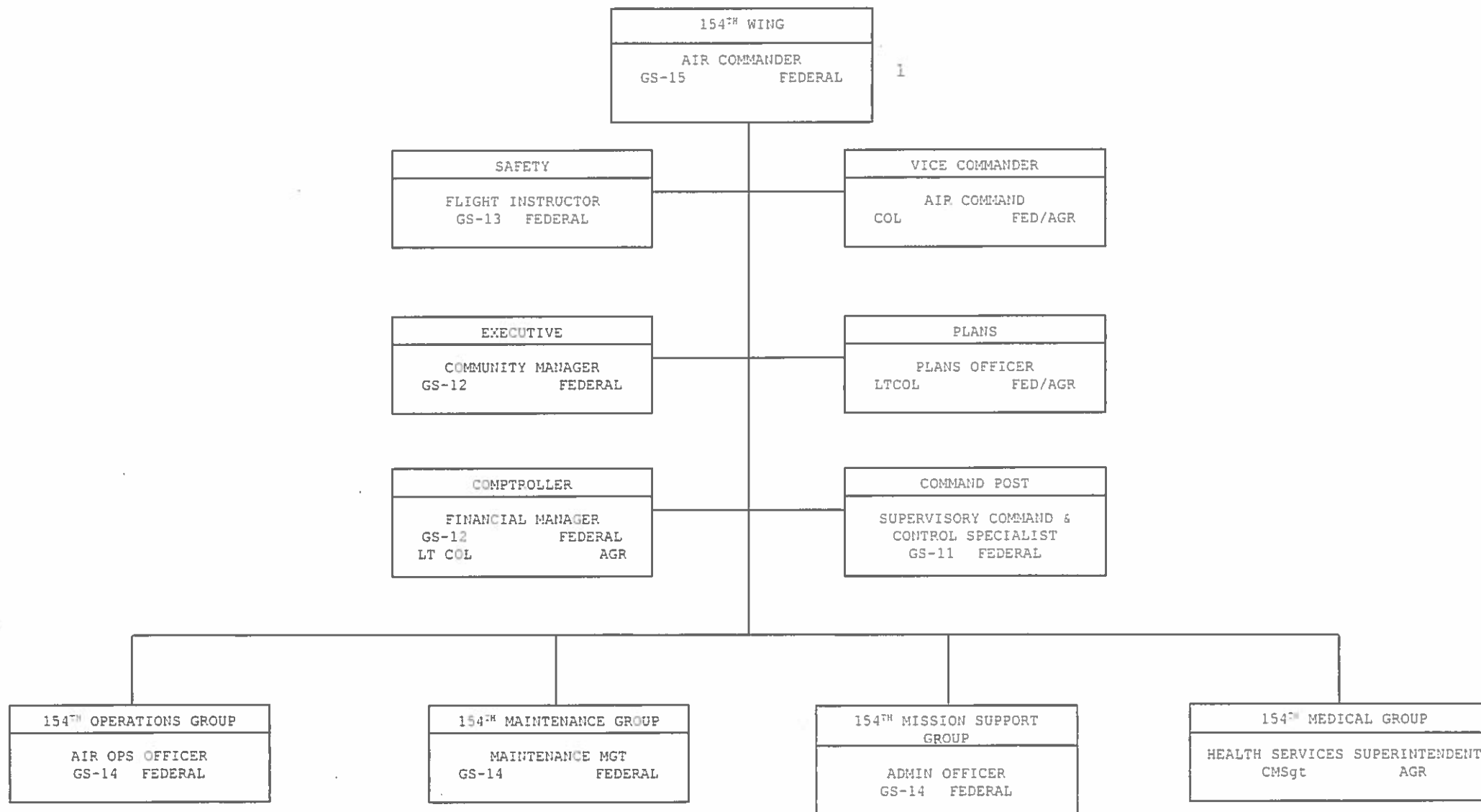

1 All assigned personnel are Federal employees.

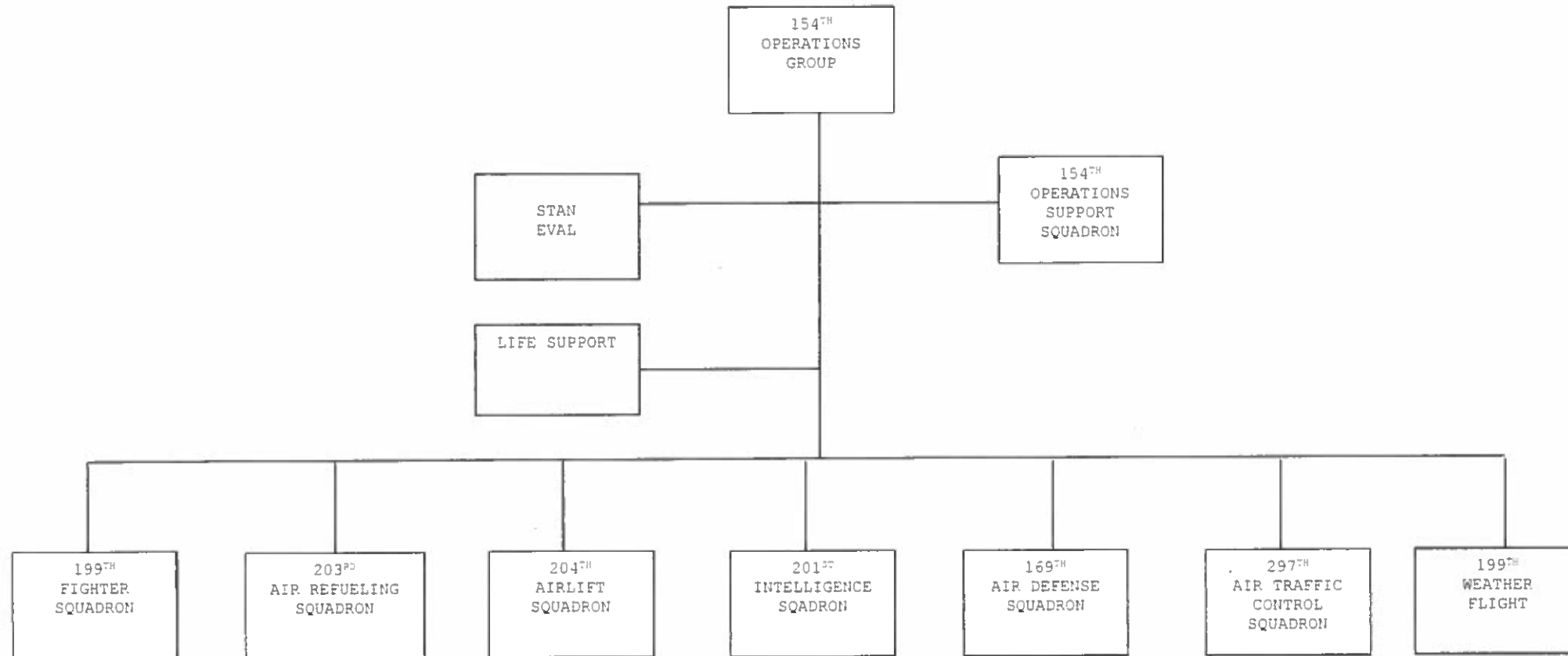

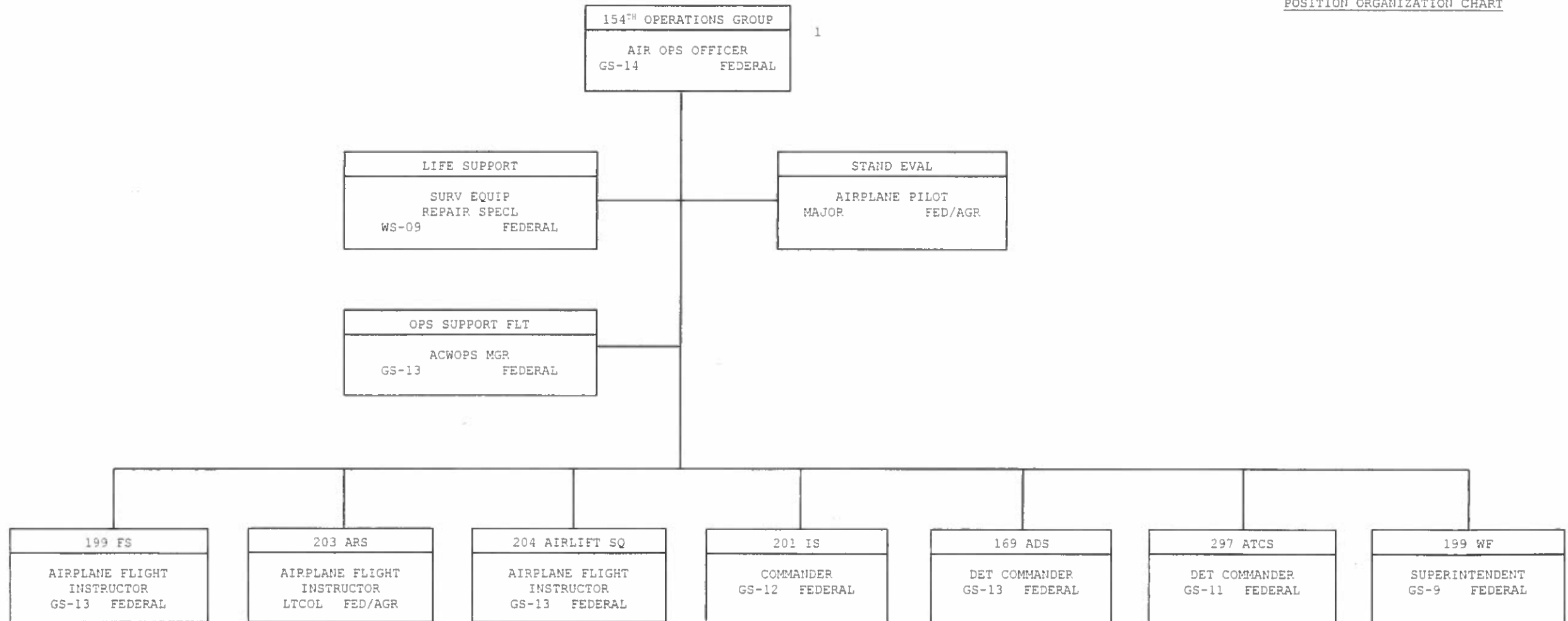

1 All assigned personnel are Federal employees.

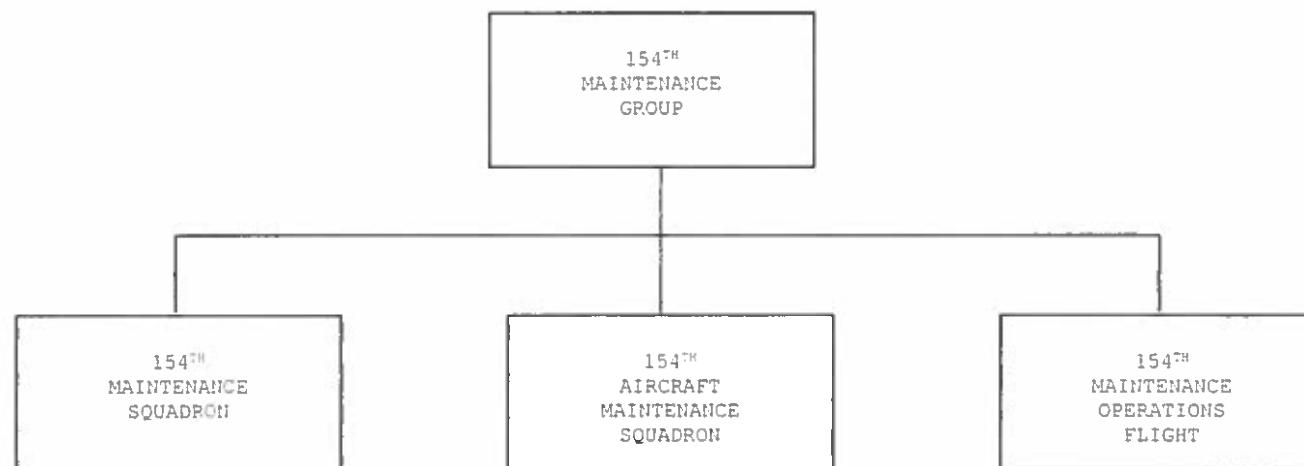

STATE OF HAWAII  
DEPARTMENT DEFENSE  
154<sup>TH</sup> WING  
154<sup>TH</sup> MAINTENANCE GROUP  
CHART NO. 83  
POSITION ORGANIZATION CHART

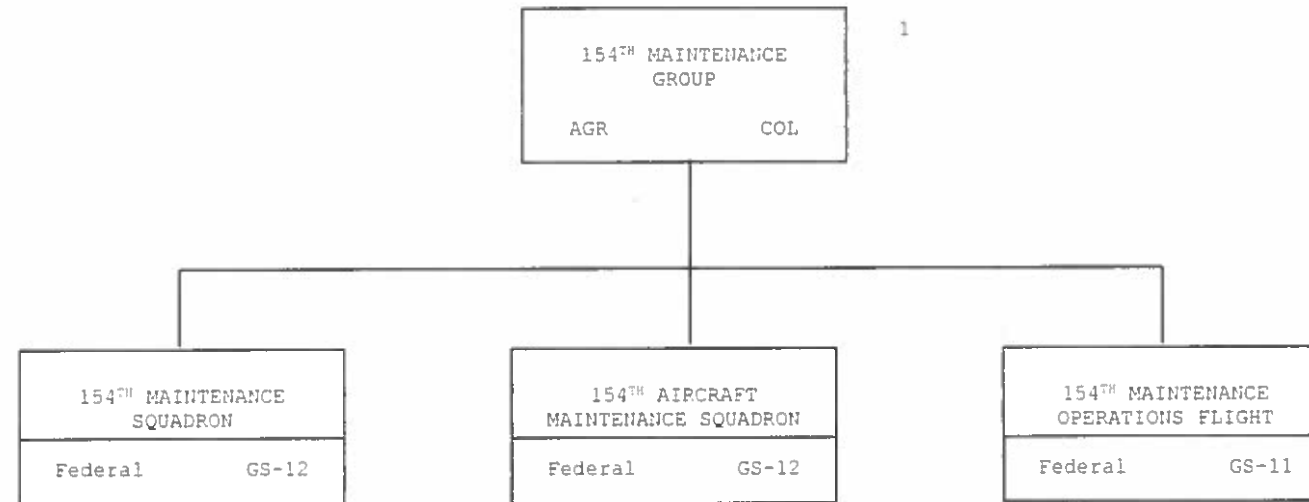

1 All assigned personnel are Federal employees.

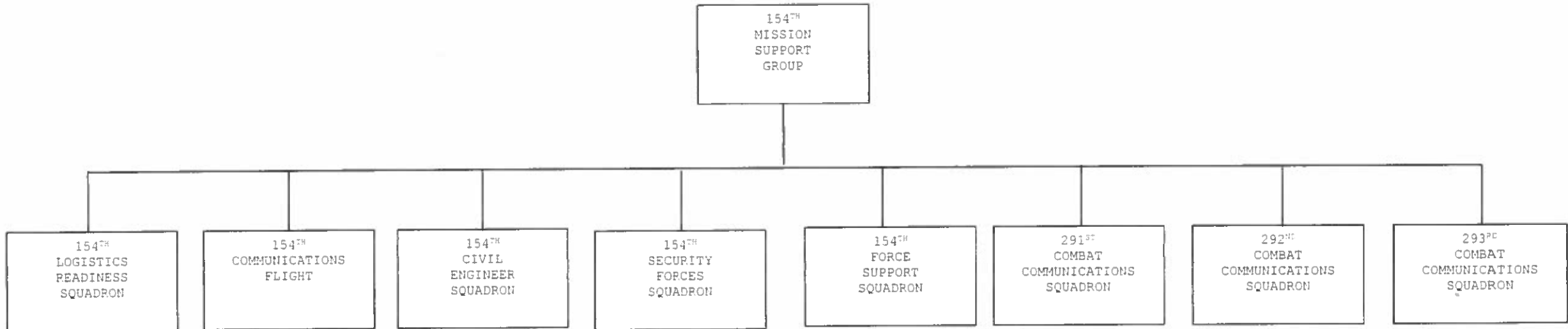

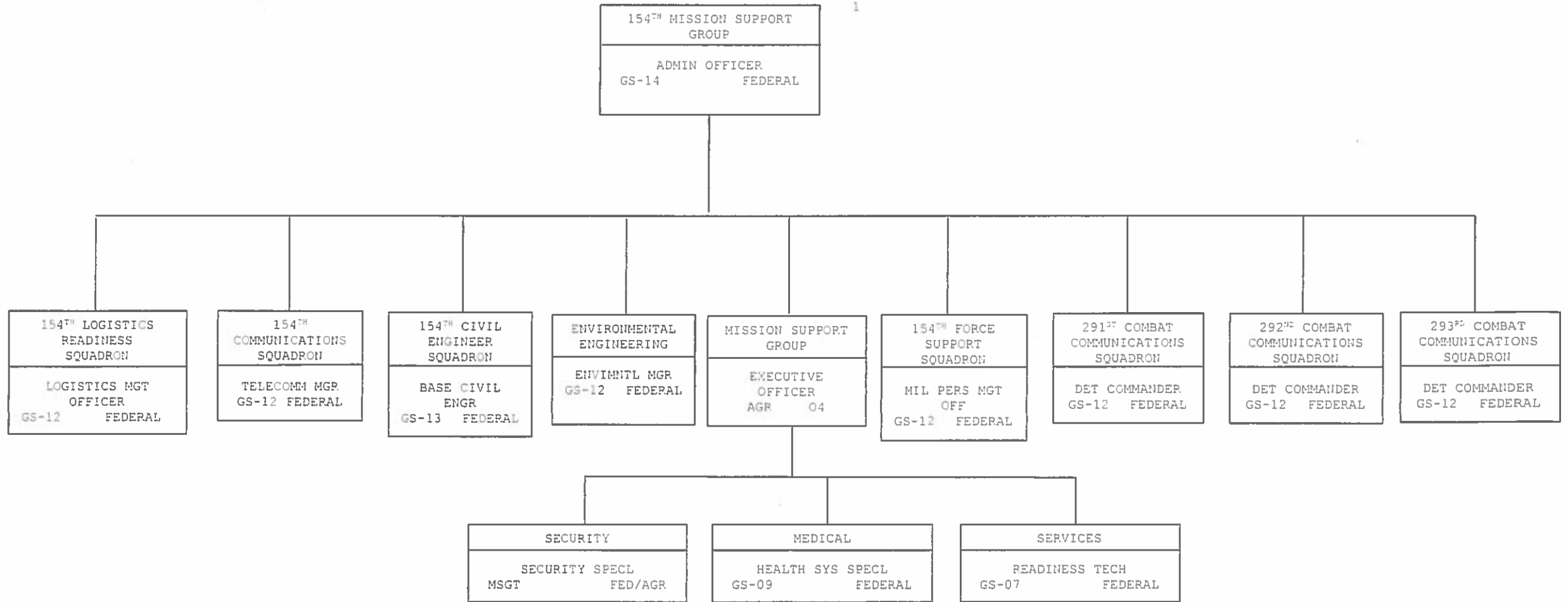

1 All assigned personnel are Federal employees.

STATE OF HAWAII  
 DEPARTMENT OF DEFENSE  
 154<sup>th</sup> MISSION SUPPORT GROUP  
 154<sup>th</sup> CIVIL ENGINEER SQUADRON  
 CHART NO. 86  
POSITION ORGANIZATION CHART

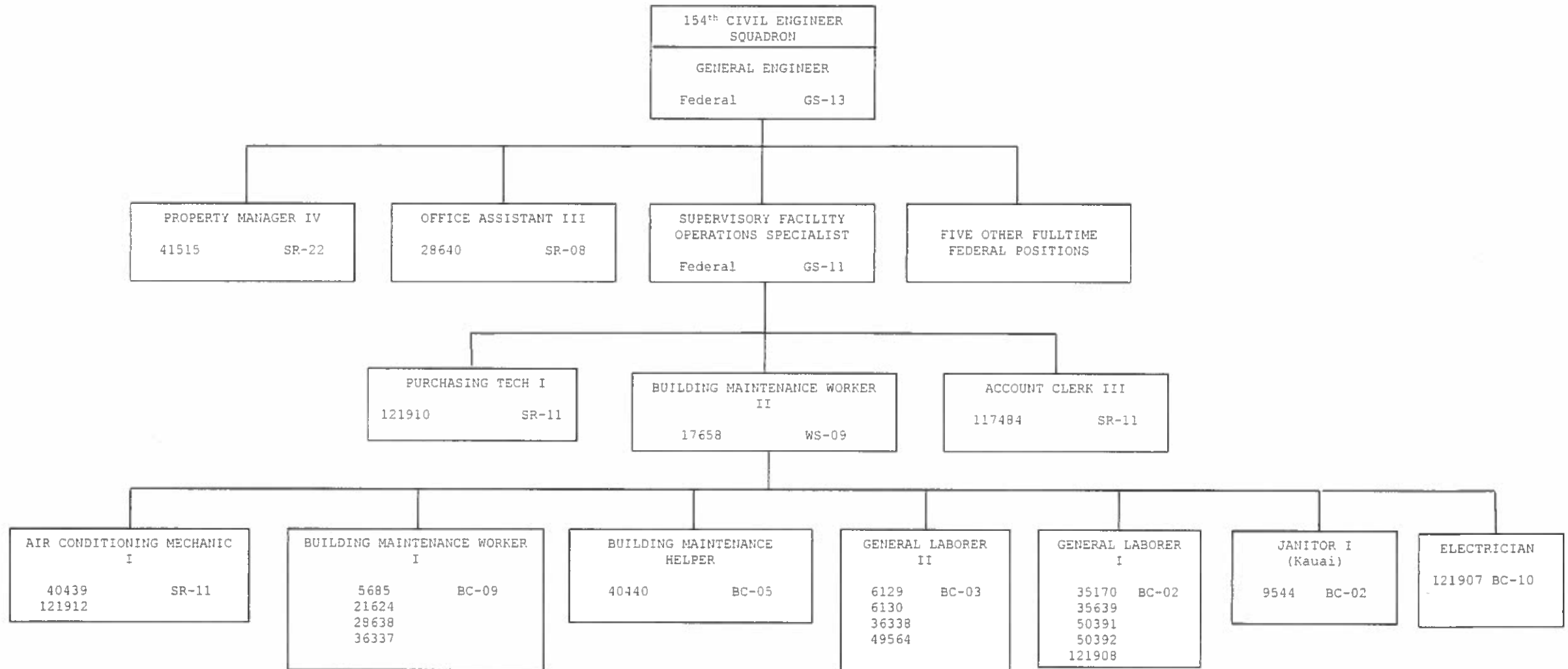



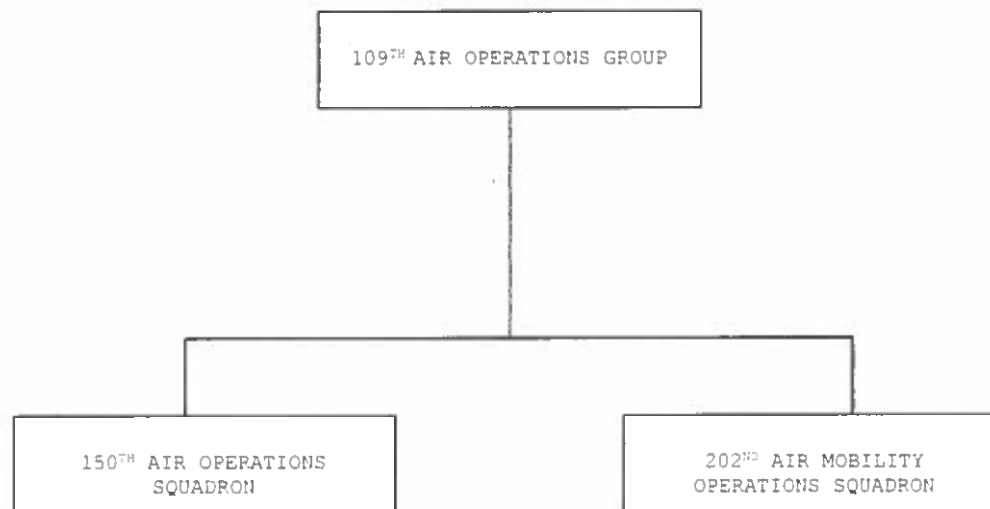

STATE OF HAWAII  
DEPARTMENT OF DEFENSE  
109<sup>th</sup> AIR OPERATIONS GROUP  
CHART NO. 88  
POSITION ORGANIZATION CHART

PROPOSED

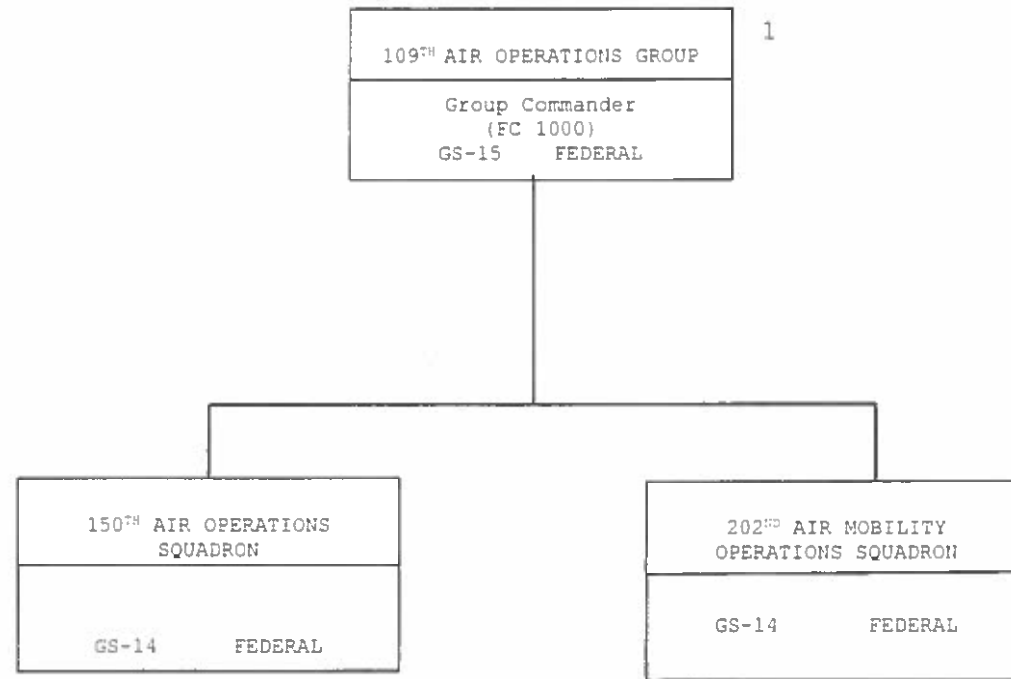

1 All assigned personnel are Federal employees.

ORGANIZATION CHART

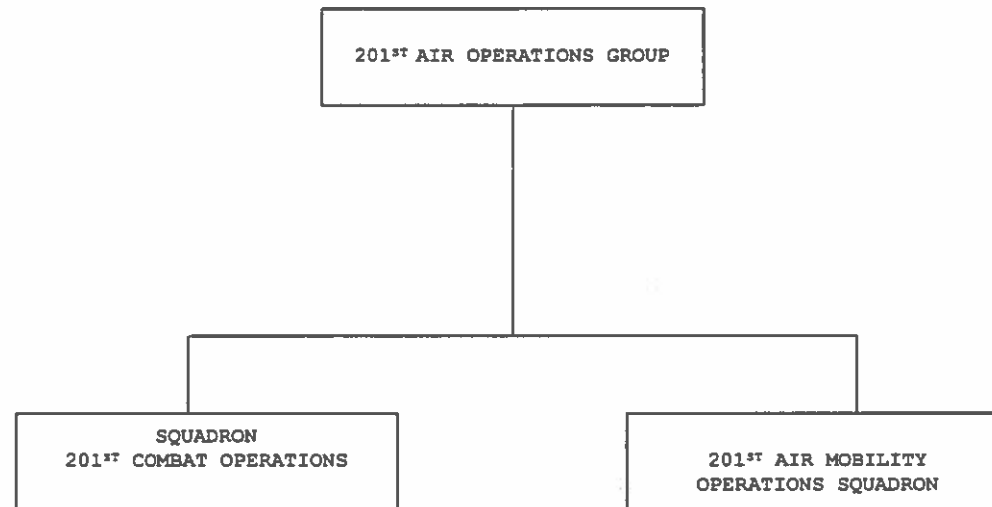

POSITION ORGANIZATION CHART

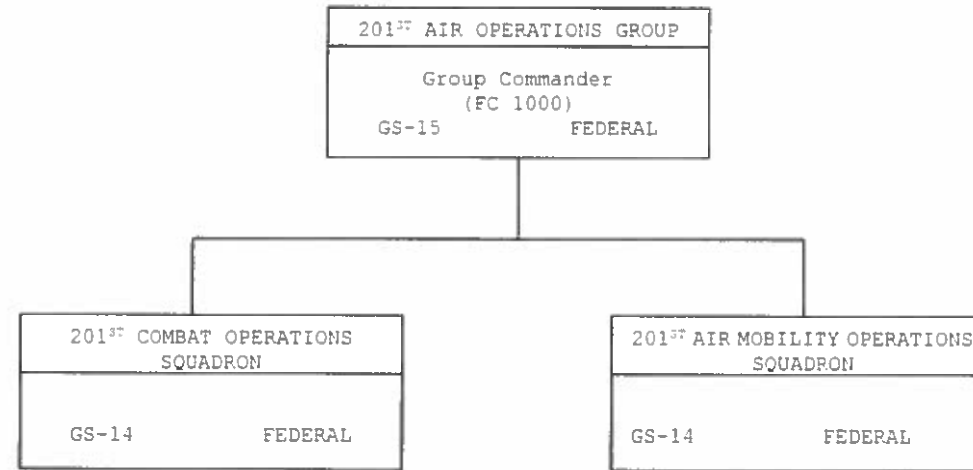

1 All assigned personnel are Federal employees.

STATE OF HAWAII  
DEPARTMENT OF DEFENSE  
HAWAII EMERGENCY MANAGEMENT AGENCY  
CHART NO. 91

ORGANIZATION CHART

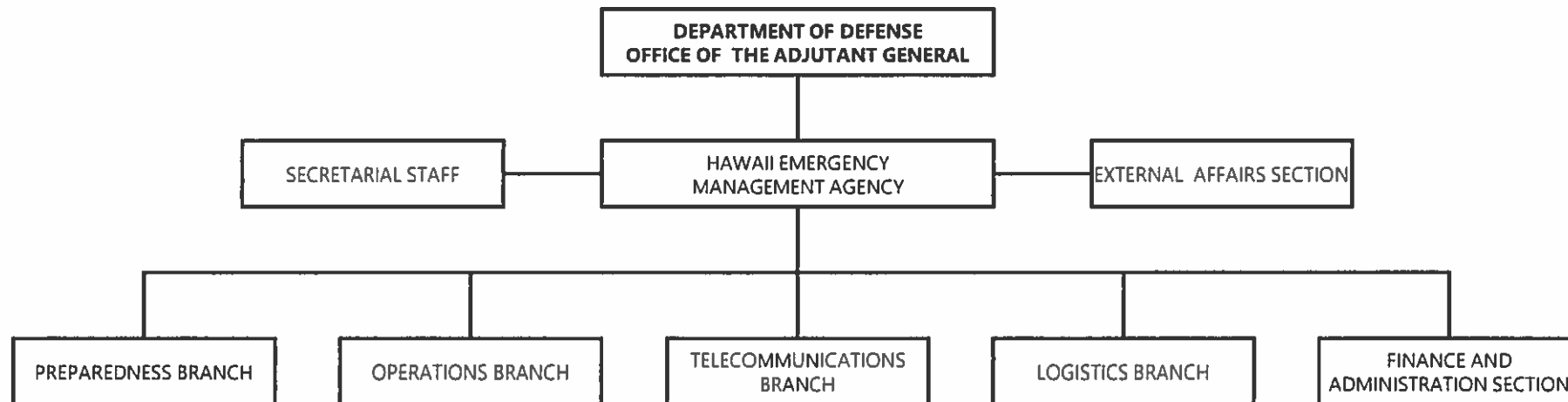

**ORGANIZATION CHART**

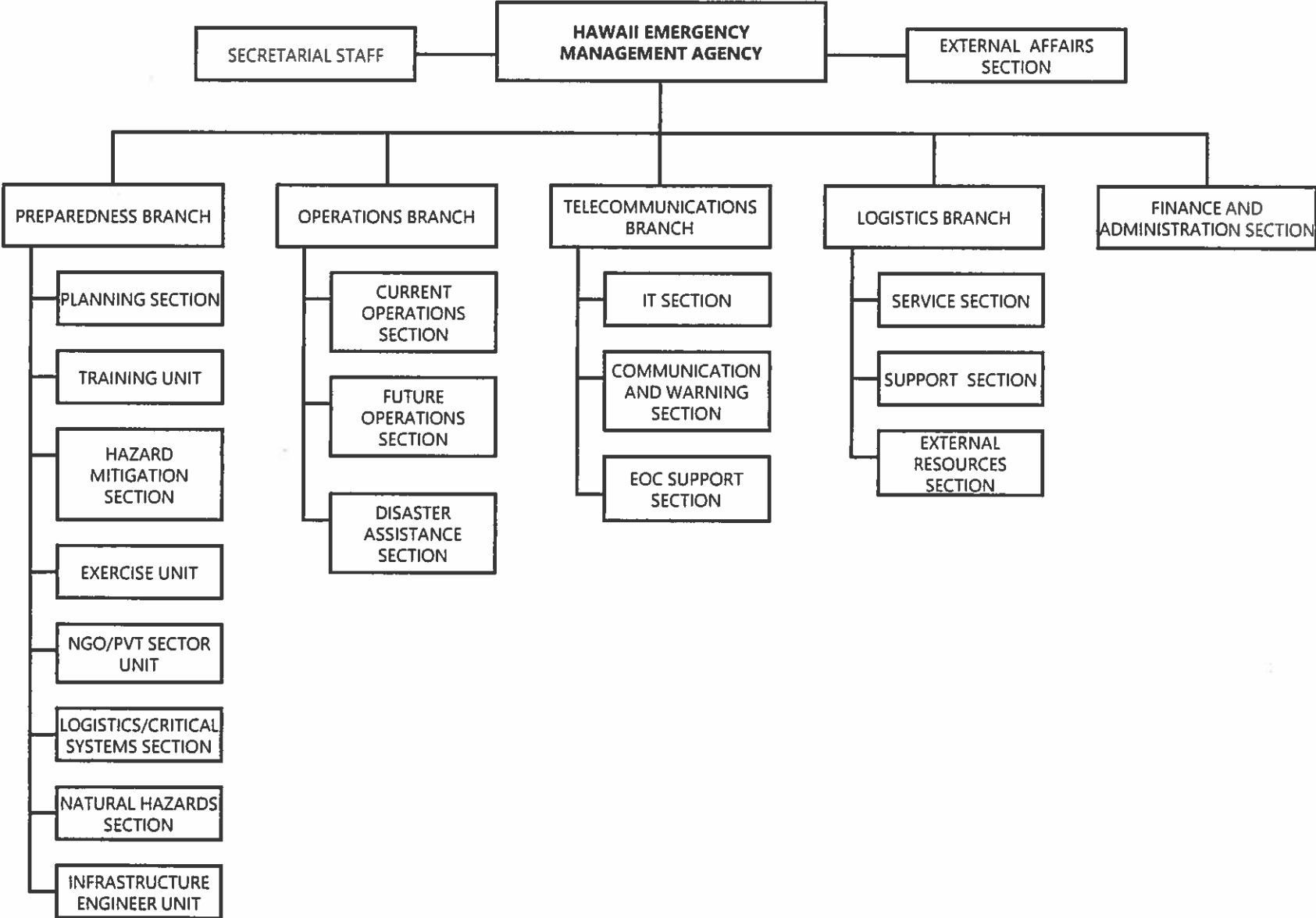

STATE OF HAWAII  
 DEPARTMENT OF DEFENSE  
 HAWAII EMERGENCY MANAGEMENT AGENCY  
 OFFICE OF THE ADMINISTRATOR  
 SECRETARIAL STAFF AND EXTERNAL AFFAIRS SECTION  
 CHART NO. 93

POSITION ORGANIZATION CHART

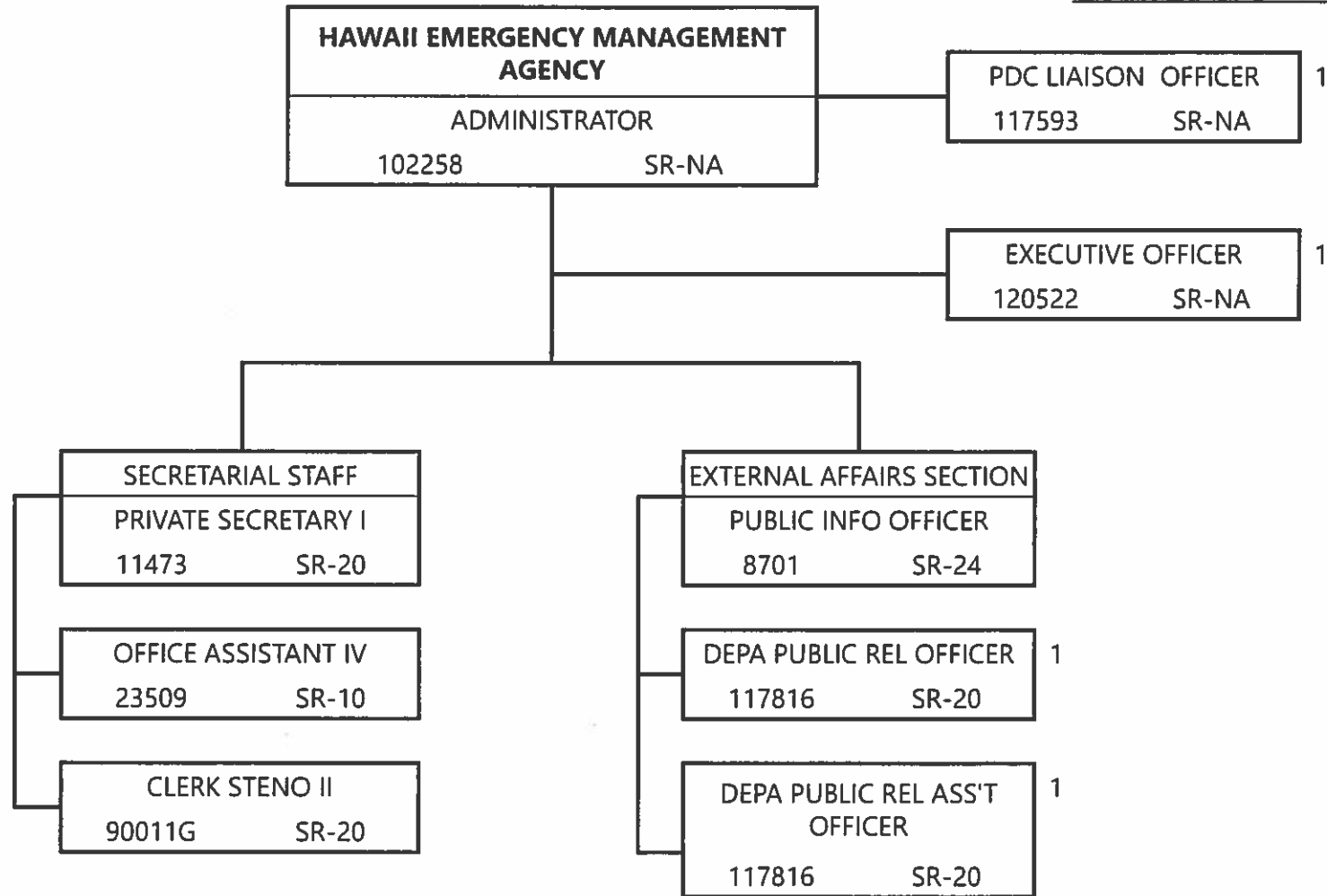

STATE OF HAWAII  
 DEPARTMENT OF DEFENSE  
 HAWAII EMERGENCY MANAGEMENT AGENCY  
 PREPAREDNESS BRANCH  
 CHART NO. 94

**POSITION ORGANIZATION CHART**

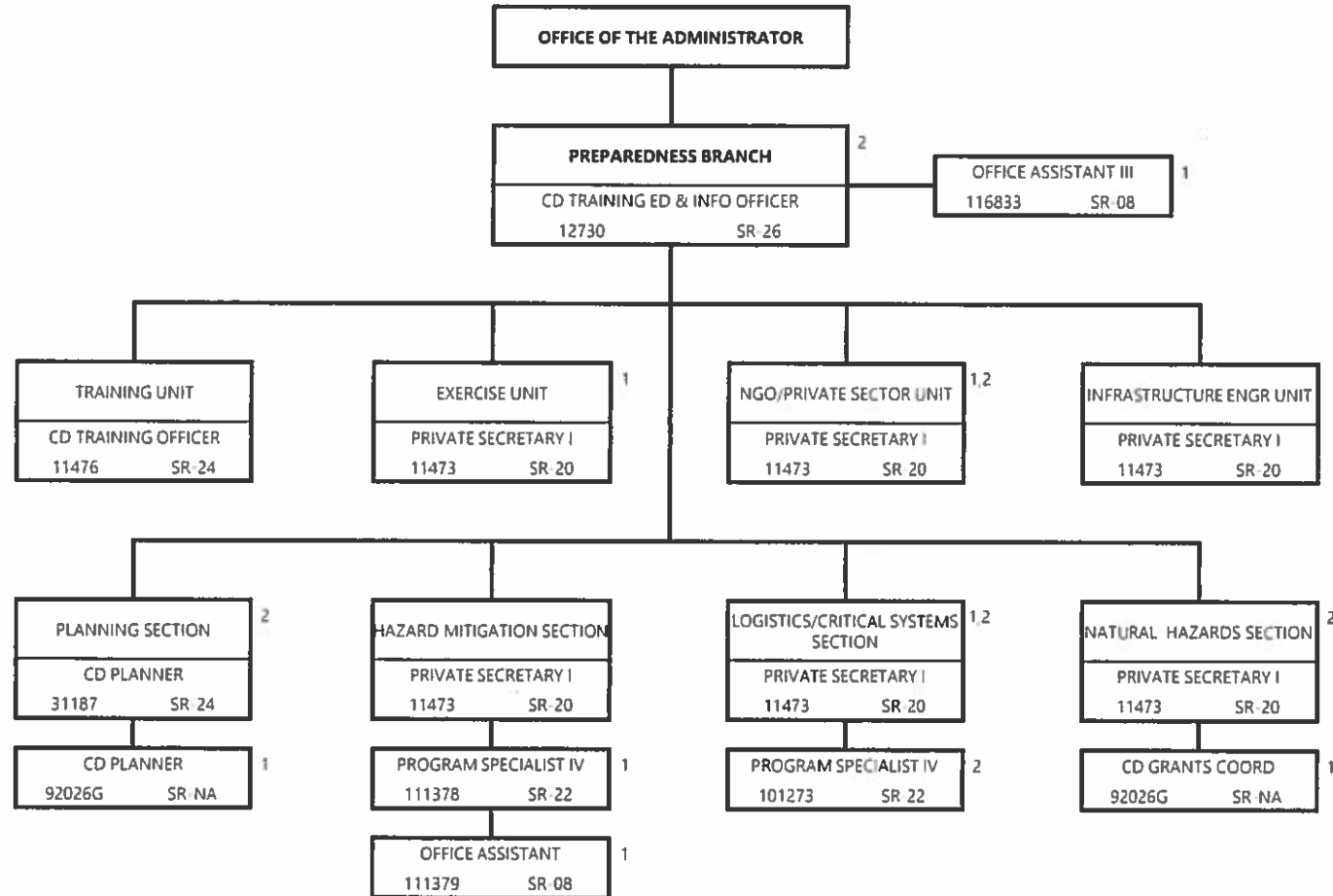

1 – Temporary Positions NTE 06/30/2019  
 2 – Position to be redescribed



STATE OF HAWAII  
 DEPARTMENT OF DEFENSE  
 HAWAII EMERGENCY MANAGEMENT AGENCY  
 OPERATIONS BRANCH  
 CHART NO. 95

**POSITION ORGANIZATION CHART**

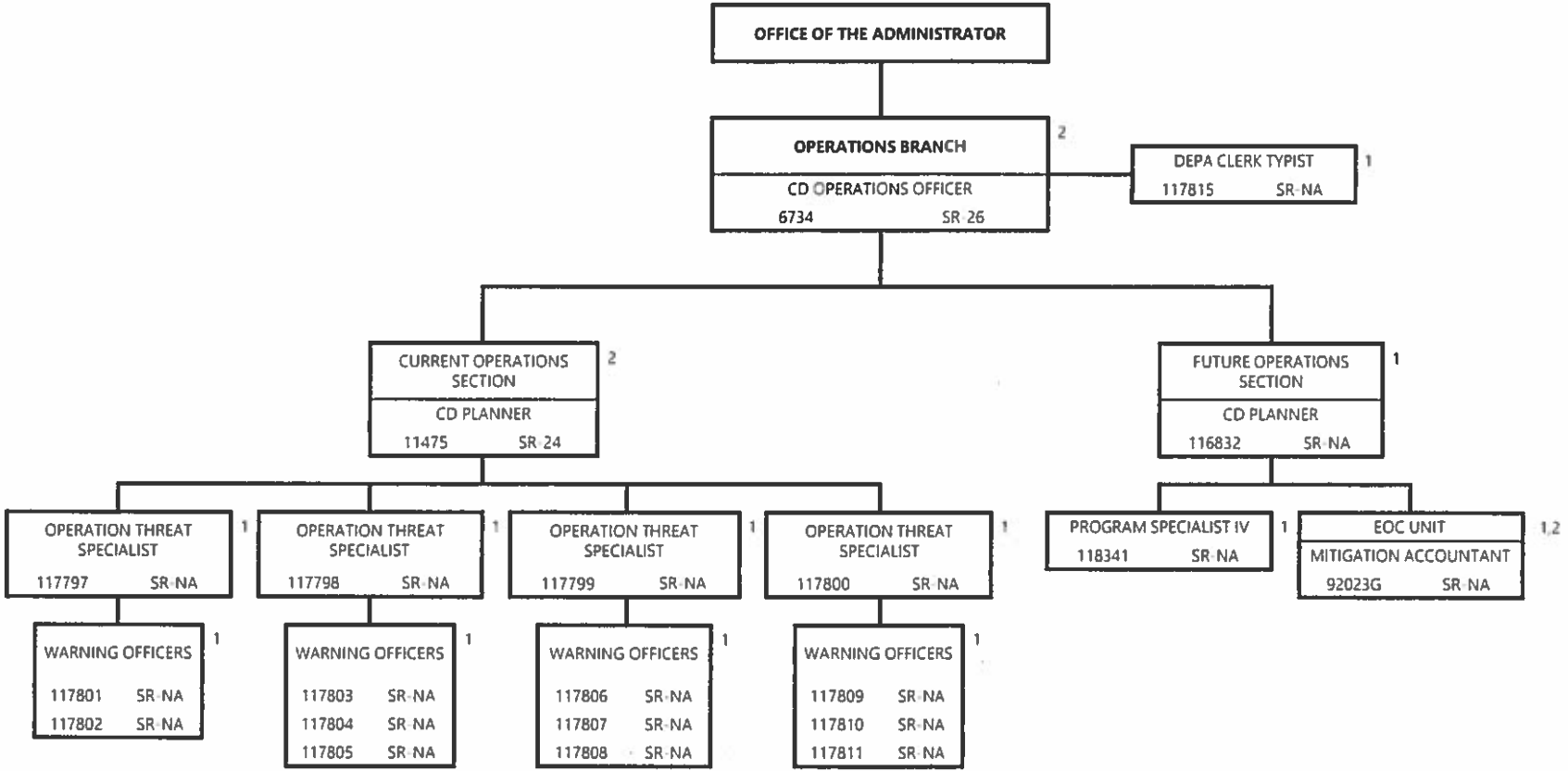

1 - Temporary Positions NTE 06/30/2019  
 2 - Position to be redescribed

**POSITION ORGANIZATION CHART**

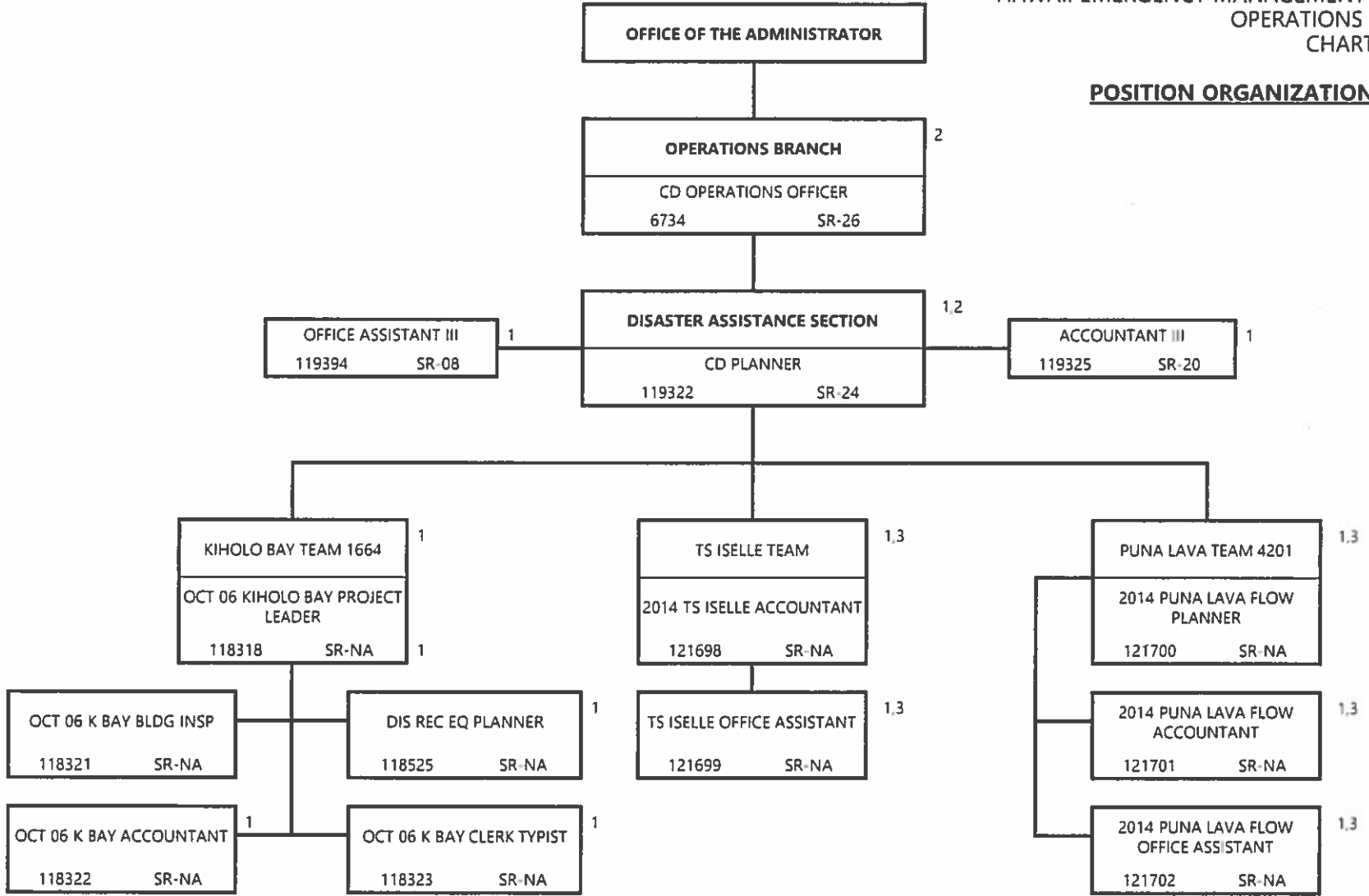

1 – Temporary Positions NTE 06/30/2019  
 2 – Position to be redescribed  
 3 – Authorized per ACT 124, SLH 2016

STATE OF HAWAII  
 DEPARTMENT OF DEFENSE  
 HAWAII EMERGENCY MANAGEMENT AGENCY  
 TELECOMMUNICATIONS BRANCH  
 CHART NO. 97

POSITION ORGANIZATION CHART

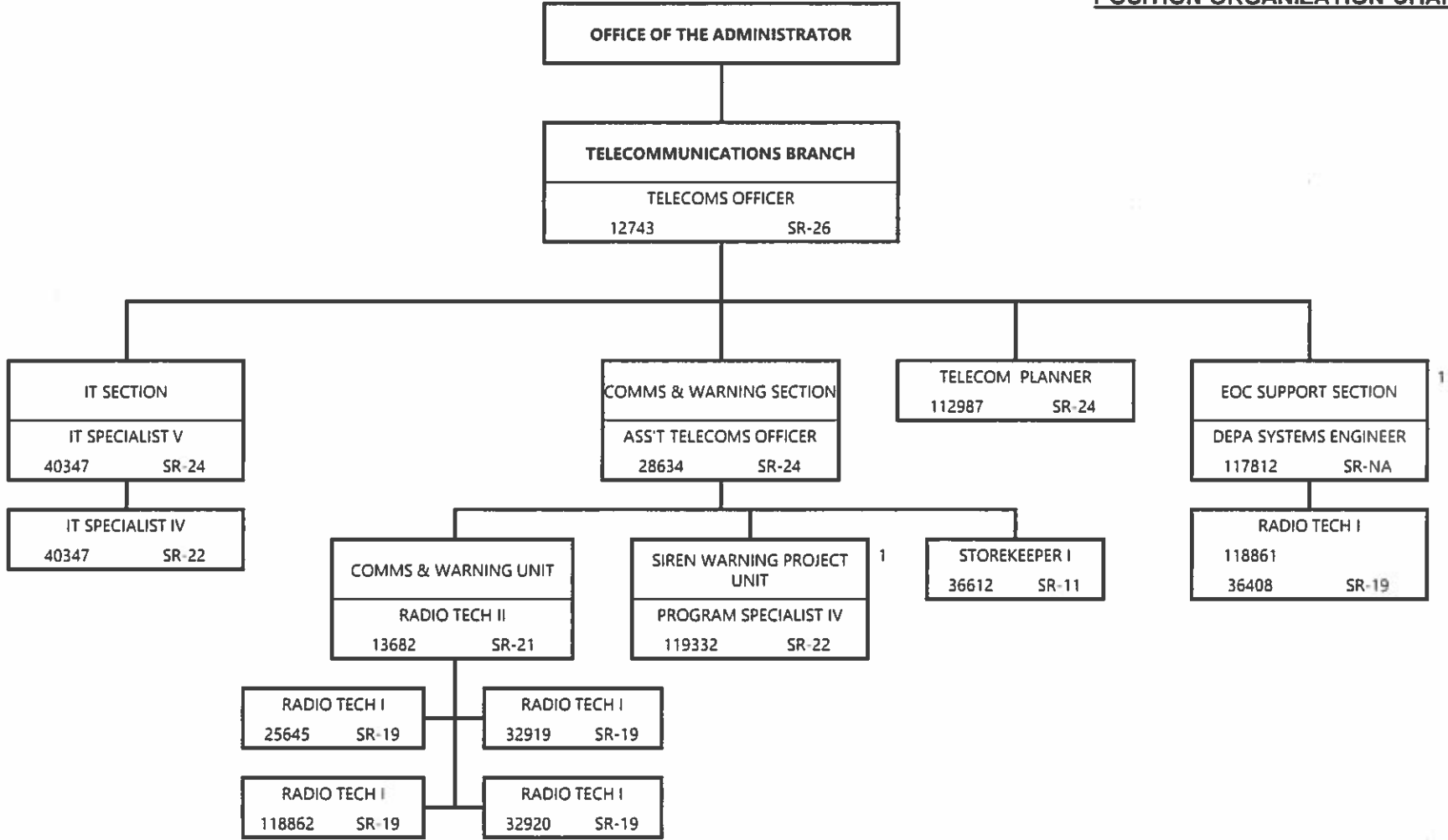

1 – Temporary Positions NTE 06/30/2019

STATE OF HAWAII  
 DEPARTMENT OF DEFENSE  
 HAWAII EMERGENCY MANAGEMENT AGENCY  
 LOGISTICS BRANCH AND FINANCE AND ADMINISTRATION SECTION  
 CHART NO. 98

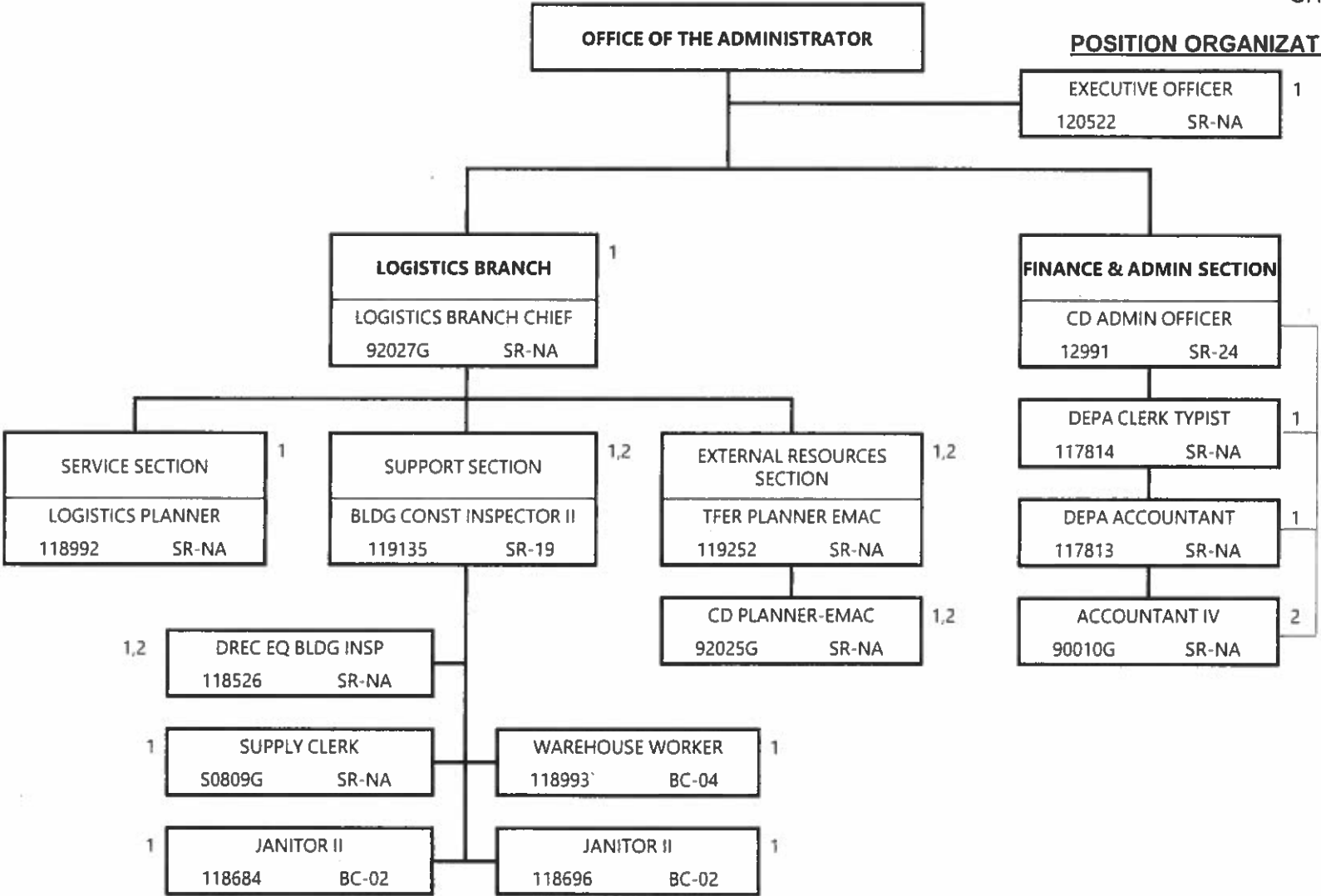

1 – Temporary Positions NTE 06/30/2019  
 2 – Position to be redescribed

ORGANIZATION CHART

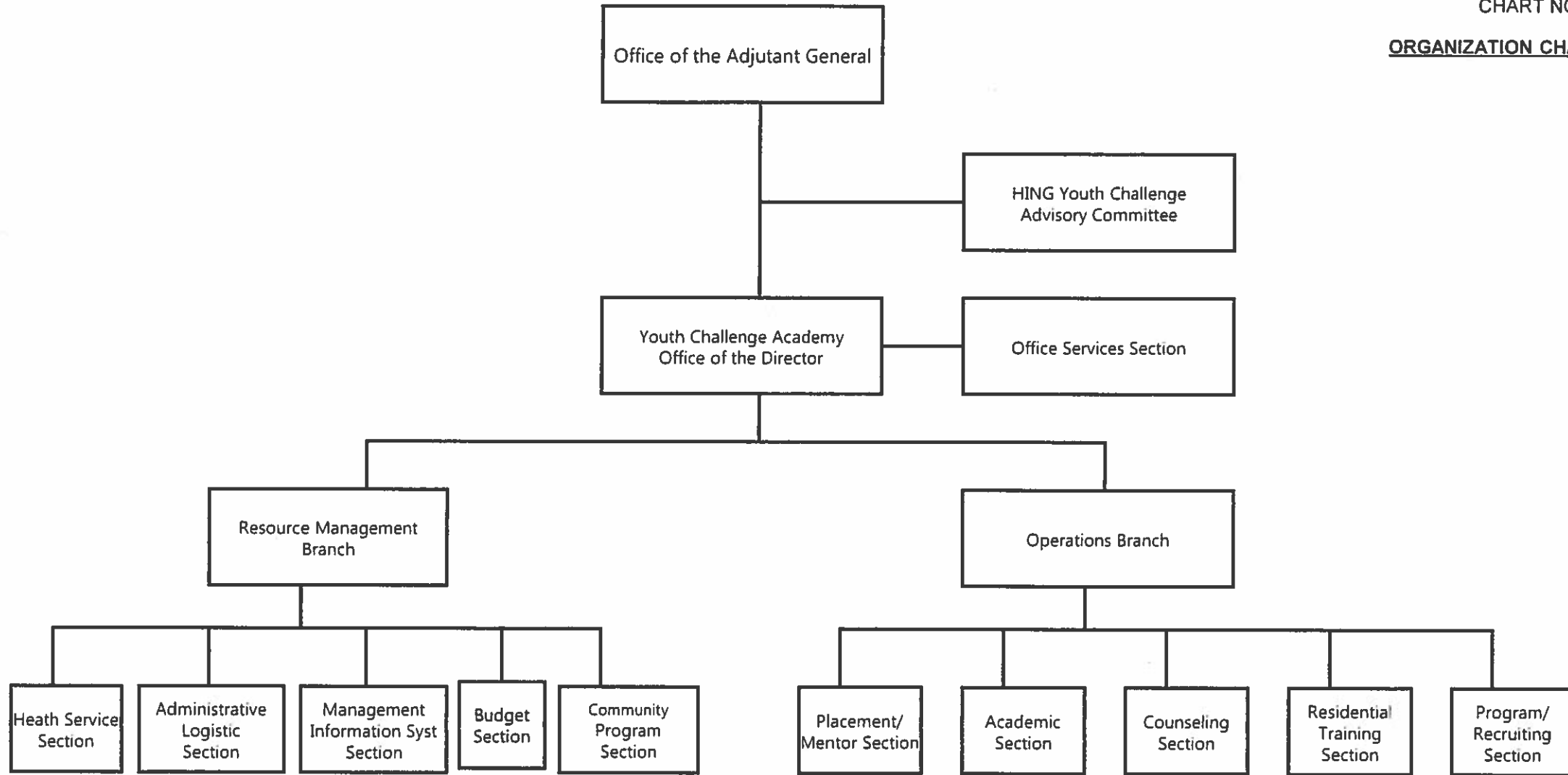

**POSITION ORGANIZATION CHART**

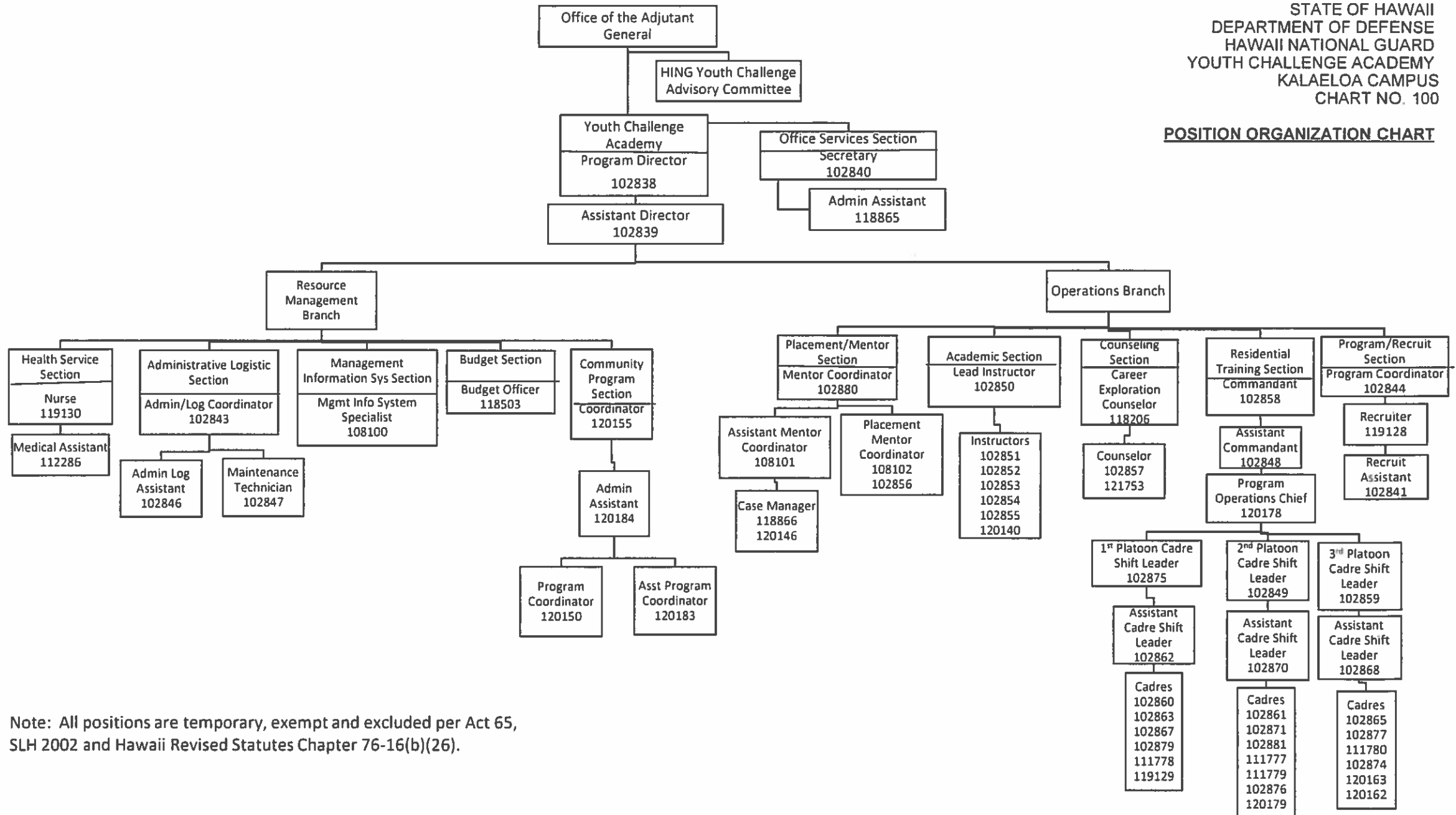

Note: All positions are temporary, exempt and excluded per Act 65, SLH 2002 and Hawaii Revised Statutes Chapter 76-16(b)(26).

ORGANIZATION CHART

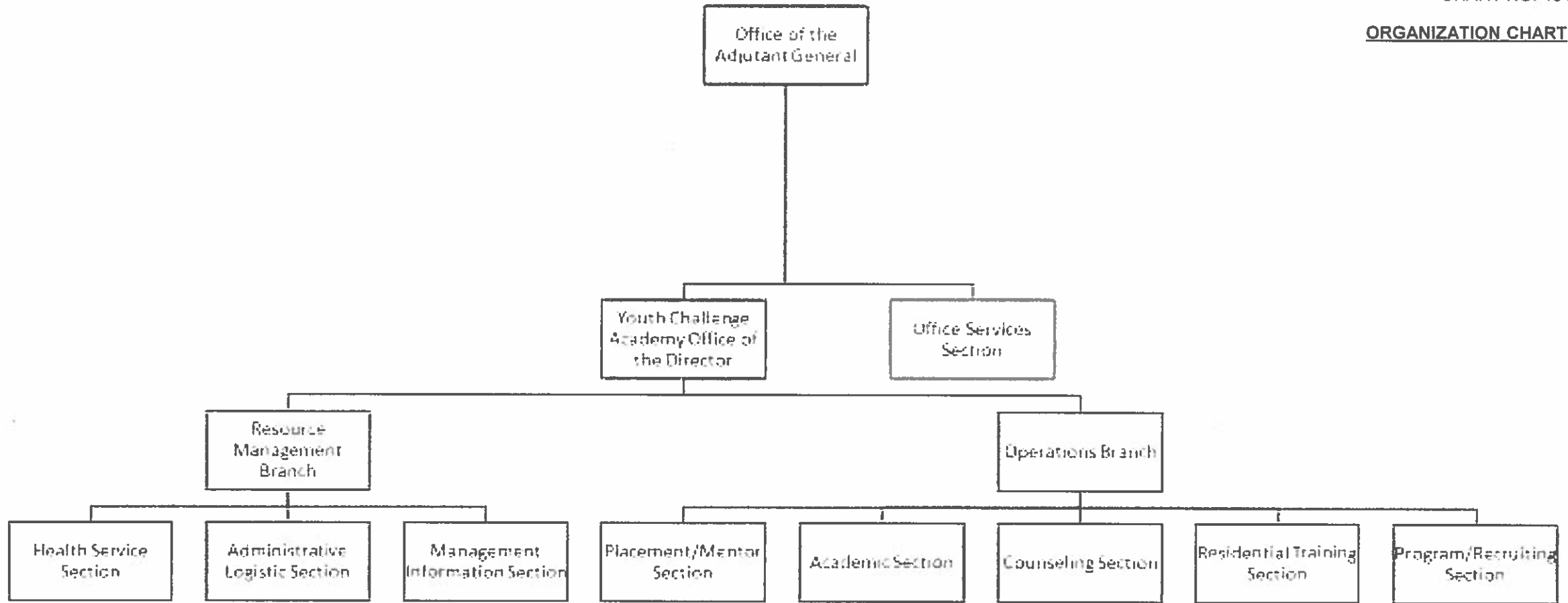

POSITION ORGANIZATION CHART

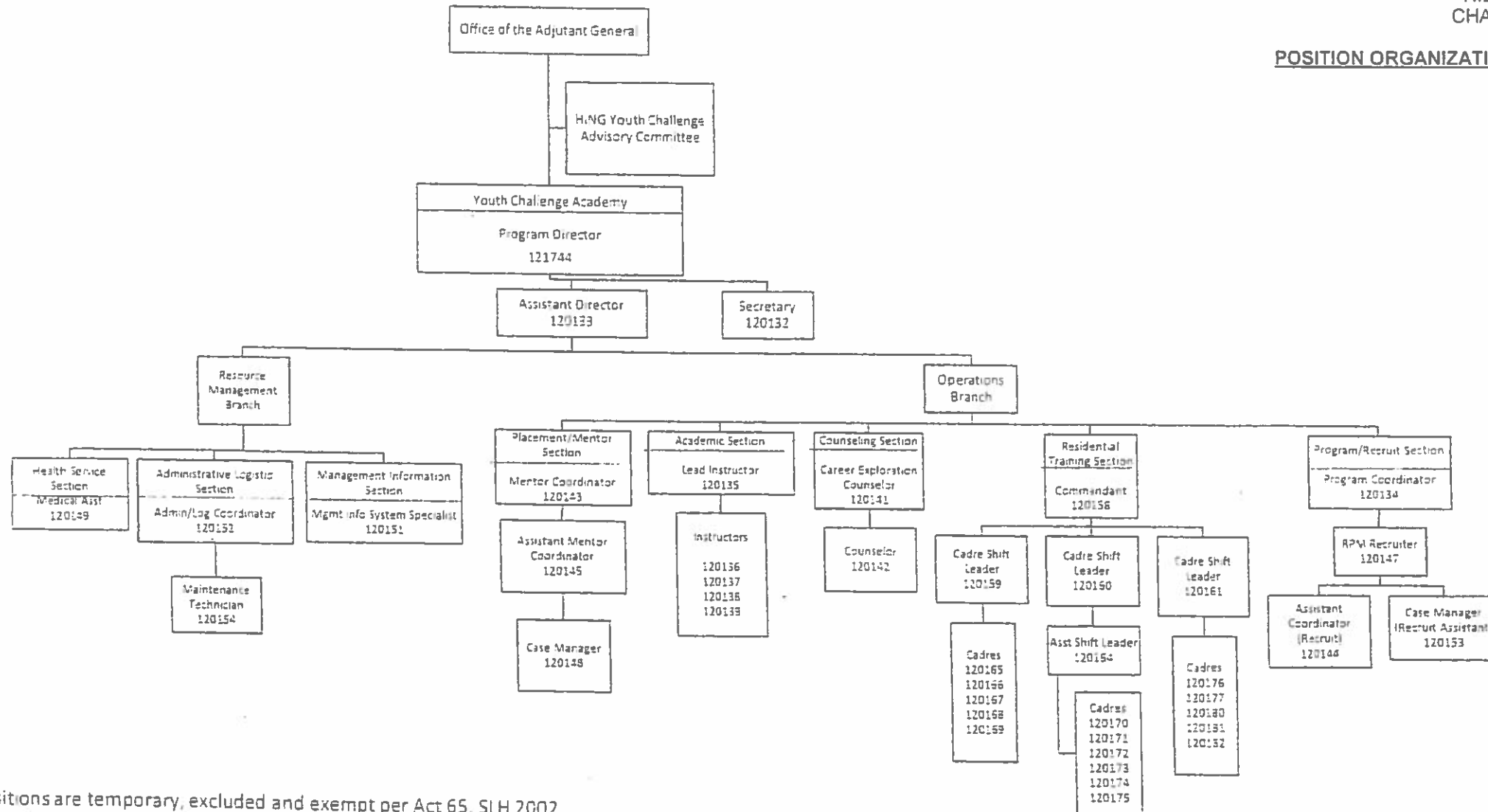

Note: All positions are temporary, excluded and exempt per Act 65, SLH 2002 and Hawaii Revised Statutes Chapter 76-16(b)(26).



ORGANIZATION CHART

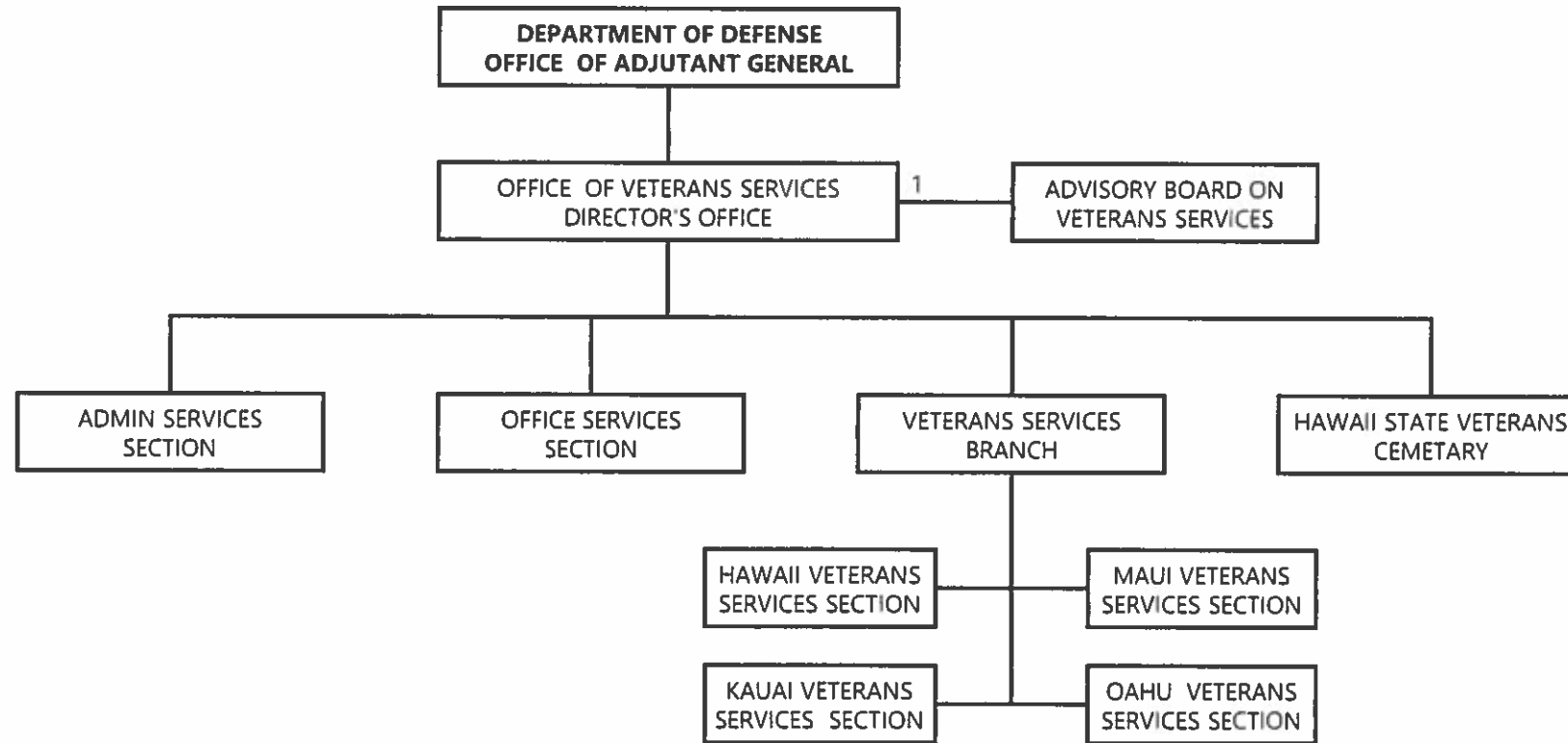

STATE OF HAWAII  
 DEPARTMENT OF DEFENSE  
 OFFICE OF VETERANS SERVICES  
 CHART NO. 104

**POSITION ORGANIZATION CHART**

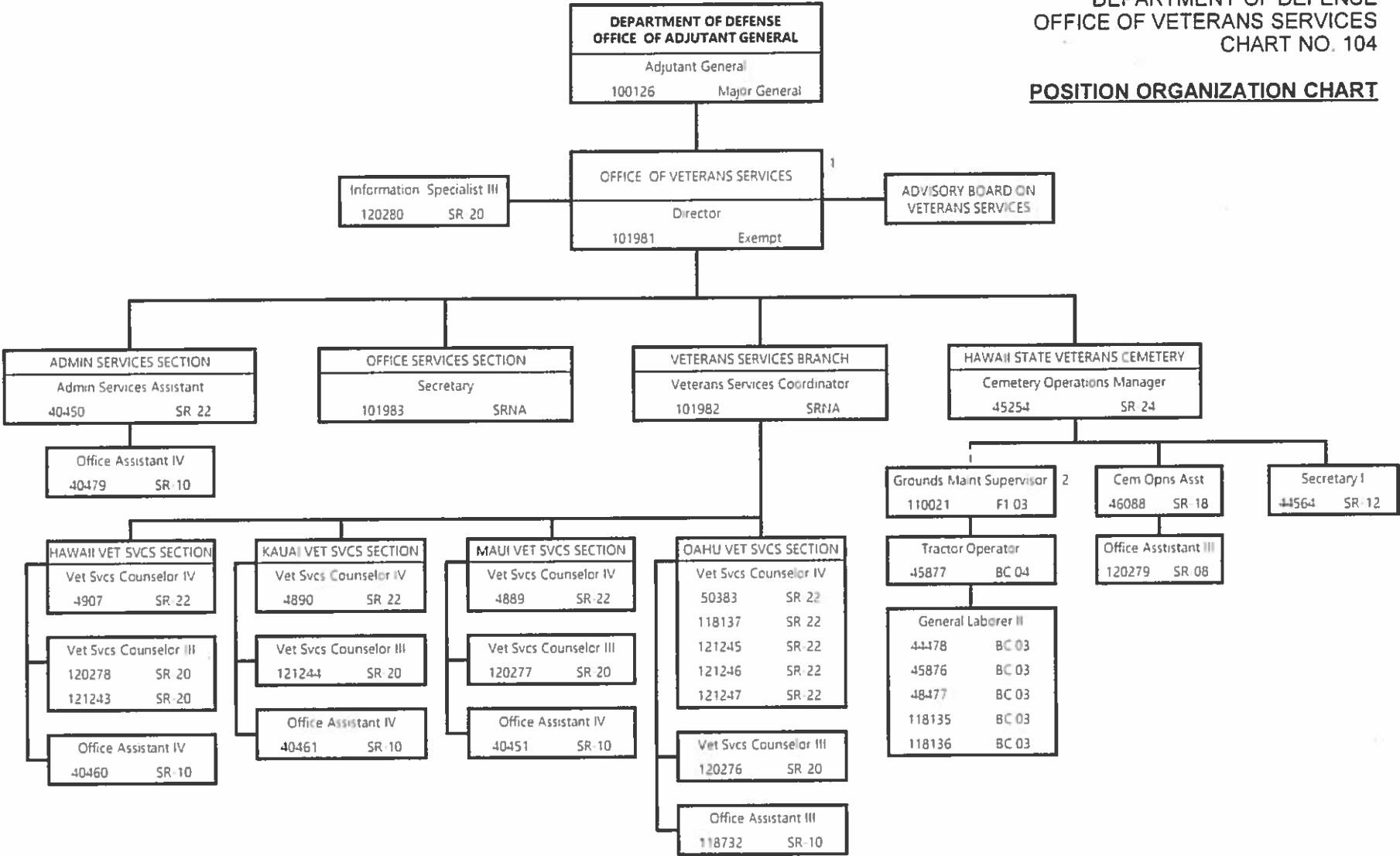

1 – Attached to Department of Defense for Administrative Purposes

2 – Pending Reorganization – All grounds maintenance positions will be transferred to DEF 110. HIENG pursuant to Act 158. SLH 2008

STATE OF HAWAII  
DEPARTMENT OF DEFENSE  
OFFICE OF THE ADJUTANT GENERAL

Under the general direction of the Governor of the State of Hawaii, plans, directs and coordinates the various activities and programs of the department within the scope of laws and established policies and regulations.

Principal policy advisor to the Governor on all matters regarding the military, emergency management services and homeland security issues.

Recommends departmental policies and organization for approval of the Governor and, after approval, directs their implementation.

Establishes policy directives, rules, regulations and procedures governing the conduct of departmental activities.

Exercises responsibility to ensure the readiness of departmental resources to respond to war or to federal or State disasters, whether natural or man-made.

Responsible for manpower, funding, equipment, weapons systems, facilities, and program changes. Exercises control over the department's federal and State funds. Directs the preparation of, and approved the DOD's federal and State operating and capital improvement budget submissions, reviews funding requests, and approves the expenditure of all departmental funds.

Serves as Commanding General of the Hawaii National Guard. Exercises command and control. Responsible for the discipline, training, and recruiting of the armed forces of the State, military operations, distribution of troops, inspections, armaments, military education and instruction, fiscal operations, administration and supply. Responsible for all State military reservations, armories, and all other property of the State kept or used for military purposes.

As Director of Hawaii Emergency Management Agency, directs the statewide emergency management system which is inclusive of all levels of government, the private sector, and volunteer organizations. Ensures the development of a seamless, integrated, and all-hazard statewide emergency management program to prevent, prepare for, respond to, mitigate, and recover from natural or man-made emergencies or disasters.

As Director of Homeland Security, is responsible for formulating and carrying out programs for homeland security and homeland defense to protect the people, infrastructure and government from terrorism and threats of attack. Ensures coordination and cooperation among all organizations such as county, state and federal public agencies, private organizations and volunteer organizations. Represents the State and the Governor during the course of intergovernmental relations as it affects the military, emergency management, and homeland security services in the State. Maintains effective working relationships with the Governor, Legislature, other governmental agencies, and the general public. Represents the department before the legislature, and community, public and private groups.

Exercises leadership in the development of a force structure that provides quick and decisive responses to the needs of the community, state and nation. Provides proactive leadership and guidance in the planning and programming process with the State, Pacific Command, National Guard Bureau, active duty components, Federal Emergency Management Agency and Homeland Security to ensure the department's missions are aligned with the needs of external stakeholders.

Responsible for the general welfare and safety of all DOD employees. Directs the establishment of comprehensive programs that ensure the safety, health, welfare and fitness of the workforce. Provides the opportunity for employees to benefit from educational opportunities that enhance productivity and the performance of core and other required competencies.

Exercises leadership, guidance, and control of the efforts of the DOD employees toward the achievements of mission objectives. Ensures an organizational climate that embraces continuous improvement, recognizes excellence and uses results-oriented measures as accomplishment indicators.

Provides leadership and direction to ensure that the department is prepared for both present and future missions. Controls departmental involvement in individual organizational training, joint exercises, and out-of-state deployments that enhance technical competencies in the performance of core readiness skills and missions. Directs the department's participation and enhancement of response capabilities to weapons of mass destruction.

Directs the planning, building, acquisition, and maintenance of equipment and facilities that further readiness, professionalism, and customer service. Continuously manage the modernization of facilities and equipment to enhance the department's capability to support future State and federal missions. Directs the coordination of facility and land use plans with State and community organizations to ensure the concerns of the public are considered and mitigated.

Provides leadership and direction to special staff, administrative services, public affairs and other support level functions to ensure effective programs that provide employment, budgeting, fiscal, public relations and information, and other staff services to the department and public.

Provides supervision and administrative support to the Office of Veterans Services, attached by law for administrative purposes.

Directs the overall activities and provides supervision over the personnel, facilities, and equipment of the Hawaii National Guard Youth Challenge Academy.

Establishes and maintains a State/federal relationship with the U. S. Property and Fiscal Officer and Office.

#### **U. S. PROPERTY AND FISCAL OFFICE (USPFO) FEDERAL**

Representative of the Federal Government. Plans, coordinates and executes the Federal financial and logistical support of the Hawaii National Guard in accordance with applicable Federal laws, regulations and directives.

As contracting officer, performs purchasing and contracting responsibilities.

Plans and arranges for transportation of National Guard personnel, equipment and supplies.  
Receipts and accounts for all funds and property of the United States in the possession of the Hawaii National Guard.  
Conducts audits of all Federal funds and U. S. property in the possession of the Hawaii National Guard.

Conducts audits of Federal funds and property.

Prepares and submits financial and logistical reports.

#### **Internal Review Division**

Conducts internal reviews/audits/management studies of all USPFO's functional elements and operations of the Hawaii Army and Air National Guard.

#### **Administrative Staff**

Maintains administrative control of correspondence and furnishes guidance in the interpretation of administrative directives and procedures, performs general office services, operates official mail desk, maintains control of classified documents, provides printing services and prepares administrative reports.

#### **Data Processing Center**

Provides data processing services to the Hawaii Army National Guard.

#### **Resource Management Division**

Responsible for the budget program, management of Federal funds, fiscal accounting, recording of fund transactions, processing technician and military payrolls and commercial and travel accounts.

#### **Supply and Services Division**

Provides material management, traffic management, supplies and property management services.

**Purchasing and Contracting Division**

Provides purchasing and contracting services for the Hawaii National Guard.

**SPECIAL STAFF (FEDERAL AND STATE)**

**Inspector General**

Inspector General (IG) inquires into and reports on matters affecting the performance of mission and state readiness, economy, efficiency, discipline, and esprit de corps of the Hawaii National Guard.

Responsible for the management of the Hawaii National Guard inspection program. Incremental parts of this program provide the TAG with an assessment of the readiness of the Hawaii National Guard to perform its federal mission.

Conducts investigations and inquiries as directed by the TAG into any activity or action performed by the Hawaii National Guard that impacts its federal mission.

Establishes and executes a responsive Inspector General (IG) Action Request Program to respond to requests for assistance by all members of the Hawaii National Guard, other Federal agencies, and private citizens.

**Staff Judge Advocate Officer**

Judge Advocate Officer provides professional legal support services to the TAG, staff elements, subordinate units of the Hawaii National Guard and the U.S. Property and Fiscal Office.

Provides legal advice and opinions, both written and oral, on issues arising from Federal laws and regulations or concerning the Federal mission of the National Guard.

Serves as the Federal litigation point of contact. Prepares litigation reports, briefs, pleadings, and other documents associated with civil litigation. May be designated to appear as counsel for the Federal National Guard officials or Federal employees.

Acts as the TAG representative in third party proceedings under the Federal labor-management relations statute. Reviews Federal technician collective bargaining agreements for legal sufficiency. As designated, participates in collective bargaining as a member of the management negotiation team.

Serves as Federal claims officer. Prepares claims report for processing of claims by the appropriate claims officer.

Participates as Staff Judge Advocate to the convening authority in National Guard courts-martial and as legal advisor or counsel in administrative board proceedings.

Reviews reports of survey, line of duty determinations and similar administrative proceeding for legal sufficiency.

Reviews Federal contracts, procurement actions, and Federal real property matters involving Federal funds for legal sufficiency.

**Youth and Adult Health & Education Program Officer**

Youth and Adult Health & Education Program Officer provides leadership and direction to various programs and projects that deal with youth and adult health and education. Provides coordination, outreach, and counseling services and ensures compliance with contract and other requirements to meet program objectives.

**Military & Logistics Support Officer**

Military & Logistics Support Officer develops long range plans to integrate State and HIARNG federal resources to ensure readiness and mission accomplishment. Develops logistics plans to ensure production standards are met and maintained within the logistical community.

**Military Chief Information Officer (MCIO)**

Military Chief Information Officer (MCIO) serves as Principal Staff Officer and primary advisor in areas of command, control, communication and computer systems in the Hawaii National Guard and civilians sector. Manages military emergency communications system and network infrastructure.

**HUMAN RESOURCES OFFICE (Federal)**

A consolidated office that provides personnel, manpower management, and administrative support services for full-time personnel programs. Serves as TAG's single point of control for Hawaii Army and Air National Guard full-time personnel programs. It adheres to a standard National Guard structure prescribed and organized with a Military Duty Management Services Branch, Equal Employment Opportunity Section, a Technician Personnel Management and Services Branch, Labor Relations Section and Personnel Systems Section.

**Military Duty Management Services Branch**

Administers the military programs based on policies and procedures established by Army, Air Force and National Guard directives. Responsible for Army, Air National Guard Active-Guard and Reserve (AGAR) personnel career management and tour retention processing, recruitment and advisory services. Point of contact for AGR administrative services and assistance pertaining to pay, benefits and entitlements.

**Equal Employment Opportunity Section**

Plans, develops and administers programs for all employees relative to equal employment, including affirmative employment with special emphasis on women and other minority issues, equal opportunity complaints processing, discrimination investigations, and related training to departmental personnel.

**Technician Personnel Management and Services Branch**

Develops policy recommendations, procedures, and plans in compliance with the U.S. Office of Personnel Management and National Guard Bureau directives. Responsible for position management and classification, manning control, staffing, training, employee relations, performance management and recognition, incentive awards, disciplinary and adverse actions, grievances and appeals, personnel management evaluations and maintenance of personnel data system. Provides employment life cycle services such as employment processing, benefits, personnel actions, recordkeeping, proper pay administration, workers' compensation program and retirement processing.

**Labor Relations Section**

Provides labor relations services such as contract administration, management advisory services and labor-management relations training. Point of contact for Union and other federal labor resolution and contract negotiations.

**Personnel Systems Section**

Provides advice, guidance and technical support on information systems. Operates the Defense Civilian Personnel Data System (DCPDS), quality control of its database, development and maintenance of Human Resources web site, and system administration for the Reserve Component Automation System (RCAS) Integrated Information Management. Integrates information management in all facets of Human Resource Office.

## **NING JOINT STAFF (FEDERAL)**

Coordinate planning, training, and execution of NG homeland defense, defense support of civil authorities, and other domestic emergency missions within the United States. Manage NG readiness and prepare NG units for mobilization for active Federal and State service consistent with applicable policies, regulations, and instructions.

### **J1 Manpower & Personnel Directorate**

Assist the Adjutant General (TAG) and Director of the Joint Staff with developing joint personnel policy, and maintaining personnel accountability during Federal and State homeland security and civil support missions.

### **J2 Intelligence Directorate**

The National Guard Joint Force Headquarters-State Intelligence Directorate (NG JFHQ-State J2) will provide the TAG and other senior state National Guard leadership intelligence assessments, estimates and other intelligence products in support of the leadership's decision-making process and to build situational and threat awareness. NG JFHQ-State J2s will coordinate on intelligence issues with the NG JFHQ-State's federal, state and local partners and NGB Joint Staff Joint Intelligence Directorate (NGB-J2), particularly as it pertains to intelligence issues related to the State Partnership Program (SPP). NG JFHQ-State J2s will support NG JFHQ-State planners and operators with Joint Intelligence Preparation of the Operational Environment (JIPOE) and Incident Awareness and Assessment (IAA) before, during and after DOD Support to Civil Authorities (DSCA) mission, Domestic Operations, National Special Security Event (NSSE), and/or exercises. The NG JFHQ-State J2 will also synchronize, develop, coordinate and disseminate intelligence plans, policies and doctrine in support of National Guard Joint Force Headquarters-State strategic and operational plans.

### **J3/7 Domestic Operations Directorate**

The Domestic Operations Directorate is responsible for planning, directing, coordinating, information sharing, and integrating all aspects of state National Guard (and DOD when requested by the State for support) efforts relating to Civil Support (CS) operations including Defense Support of Civil Authorities (DSCA).

### **J4 Logistics Directorate**

The Logistics Directorate is responsible for integrating, coordinating, and synchronizing service component logistics capabilities, logistics planning and execution in support of joint federal and state operations.

### **J5 Plans, Policy, & International Affairs Directorate**

NG JFHQ-State Plans, Policy and International Affairs Directorate is responsible for developing and coordinating the joint strategic policy, plans, initiatives related to, theater security cooperation, international relations, federal and state homeland security and civil support missions.

### **J6 Command, Control, Communications and Computer Directorate**

Responsible to the Adjutant General as NG JFHQ-State focal point for Command, Control, Communications and Computer systems planning, coordination, and other functions related to ensuring adequate and effective C4 support for Homeland Defense, Defense Support to Civil Authorities, and Homeland Security (HD/DSCA/HS) mission requirements.

### **Medical**

Serves as joint medical operations advisor to the TAG, Hawaii National Guard Chief of Staff, and commanders and medical liaison officer. Plan, coordinate and facilitate joint command medical operations, provide medical operations expertise for Hawaii National Guard medical support for civilian-military operations, humanitarian assistance and other medical missions.

STATE OF HAWAII  
DEPARTMENT OF DEFENSE  
ADMINISTRATIVE SERVICES OFFICE

Under the general direction of the Adjutant General (TAG), the Administrative Services Office (ASO) provides State executive administrative management services and support to the Office of the Adjutant General.

Exercises responsibility for providing executive management services and support to the Adjutant General. Coordinates and controls all administrative communications directed to the Office of the Adjutant General.

Manages the department's State and Federal legislative programs. Reviews and prepares or coordinates on all testimonies, reports, and correspondence submitted to the Legislature, Governor, congressional delegation or other State and Federal agencies. Maintains liaison with the State Legislature and Hawaii's Congressional delegation.

Manages the development and implementation of departmental administrative policy directives, regulations and procedures.

Provides department-wide budget and financial management services. Provides purchasing and procurement services, conducts studies and responds to outside funding opportunities, manages departmental inventory. Provides state human resources management services.

Exercises responsibility for managing the quarterly reporting and analyses of Federal and State expenditures. Provides TAG with analyses and recommendations.

Manages the department's organization program. Responsible for evaluating the effectiveness and efficiency of departmental organizations and programs. Conducts a staff review and provides TAG with an analysis of requests for organizational changes to ensure compliance with statutes, State and federal guidelines, and basic organization principles. Assists with Union consultations or reorganization proposals. Assists with proposal submissions to the Departments of Budget and Finance and Human Resources Development as required.

Directs and coordinates the department's planning, programming and budgeting (PPBS) activities and maintains budgetary and fiscal controls over Federal and State funds appropriated to the department.

Exercises control over the department's budget management system. Ensures State and federal expenditures comply with TAG's priorities. Analyzes State and Federal budget instructions for departmental impact. Develops departmental budget instructions based on analysis of Governor's budget instructions and TAG's priorities. Coordinates, consolidates and assists with prioritization of the departmental budget submission to the Governor's Office. Assists with Legislative requests for budget justifications and testimonies. Responsible for proper budget execution in compliance with state rules of appropriations, allocations and expenditures.

Develops appropriate evaluation mechanisms to ensure compliance with Federal, State, and departmental policies. Conducts program evaluation to measure program execution at all levels of the department.

Secretarial Services

Provides secretarial and clerical support services. Also provides for mailing and messenger delivery activities for the department.



### Financial Management Staff

Directs and controls the purchasing, procurement and contracting activities in compliance with state and federal rules and regulations, and formulates policies and procedures for the management of authorized funds and property.

Provides financial oversight to ensure the allocation and expenditure of resources are consistent with all requirements and TAG's approved plans and policies.

Exercises responsibility for administering and controlling State general fund appropriations and allocations, the State-administered federal funds, and matching fund grants under the department's cooperative agreement and Federal programs.

Reviews and estimates funding requirements for Federal grants and contracts and processes and audits State and County claims for Federal contracts and reimbursements.

Maintains the departmental inventory and assists program administrators on inventory requirements, including control, recordkeeping and disposal processes.

Establishes and implements policies and procedures on departmental records management systems.

Maintains accurate records and ledgers of financial transactions, federal drawdowns, State Treasury deposits, account balances, and expenditures of State and Federal funds.

Prepares and submits accurate payroll documents for the Department. Verifies and reviews vouchers for accuracy and compliance with State and Federal rules and regulations.

Ensures that all procurement and pre-audit activities are in compliance with procurement rules and regulations and audit procedures. Reviews pCard expenditures and payments for accuracy and compliance.

### State Human Resources Staff

Oversees the coordination and compliance to all Department of Human Resources Development personnel rules and regulations, policies and procedures, and negotiated Union agreements.

Promulgates regulations and departmental policies related to the management and administration of State human resources.

Exercises responsibility for administering the State human resources programs within the department which includes classification, compensation, recruitment, selection and placement, personnel transactions and records, labor relations, employee relations, performance evaluations, employee development and training, employee recognition and awards, workers' compensations, and occupational health and safety.

**PUBLIC AFFAIRS OFFICE**

Provides public information and public relations services for the department.

Plans, develops, directs and administers the department's community relations and public and internal information programs. Oversees the release of information to the public and serves as spokesperson during disasters or incidents related directly to public safety.

Responds to queries from the news media, public and other state and federal agencies.

Maintains liaison with military and civilians information media representatives.

Provides briefings for civilian and military officials, community groups, and new departmental employees to inform them of the DOD's mission and its economic and education contribution to the State.

Writes speeches annually for the State Adjutant General. Observes and studies trends in public opinion. Manages all Internet development activities conducted by the DOD.

Prepares and distributes news releases, photographs and video on the departmental activities to civilian and military news media locally and out-of-state.

Provides technical assistance for departmental briefings, setting up computer equipment, projectors, microphones and other pertinent software and hardware.

Conducts research for speeches given by the TAG. Publishes a semi-quarterly publication, for distribution to present and retired Hawaii National Guard members, state and federal agencies, and other parties interested in departmental activities.

Provides technical support, maintenance and programming design for Internet web pages which provides valuable information. Assists National Guard recruiters, offices and departments on all issues related to the DOD world wide web development and maintenance program.

Maintains the OVS' presence on the Internet by designing and updating the OVS web page.

Consolidates, edits, publishes and distributes the department's annual report and Economic Contributions Statement.

**STATE OF HAWAII**  
**DEPARTMENT OF DEFENSE**  
**ENGINEERING OFFICE**

Under the general direction of the Adjutant General (TAG), the Engineering Office provides the entire spectrum of professional engineering services to all major organizational segments of the department. The engineering services encompasses programming/budgeting, planning, designing, advertising and awarding professional services, construction and other miscellaneous goods and services contracts, construction management, land and real property asset management, and facility maintenance and repair. Additionally, it manages the operations of the department's state motor pool.

Administers, manages, and directs the department's statewide Capital Improvement Projects (CIP) Program for the Hawaii Emergency Management Agency, Office of Veterans Services, Youth Challenge Academy, the Hawaii Army National Guard and the Hawaii Air National Guard divisions in compliance with both State and Federal rules and regulations, as applicable.

Administers, manages and provides direct support to the department's statewide major and minor construction programs for the Hawaii Army and Air National Guard in compliance with both State and Federal rules and regulations.

Administers, manages and directs all state contracting for the department, statewide, including but not limited to security guard, custodial services, refuse and recycling collection and disposal, air conditioning maintenance, elevator maintenance, oil & water separator and grease trap maintenance and other service related contracts.

Administers, manages, and directs the department's combined in-house and contract program for the maintenance and repair of all department facilities, statewide.

Administers, manages, and directs the department's janitorial/custodial, ground maintenance, and trades repair and maintenance program, and other service related contracts, statewide.

Administers, manages, and directs the department's combined in-house and contracted program for the operations of the state motor pool.

Administers, manages, and directs the department's real property program statewide via the preparation and execution of Use Permits, License and Lease Agreements, Memorandums of Agreements, and Memorandums of Understanding.

Administers, manages, and directs the department's fire prevention and protection program through the divisions, statewide.

Administers, manages, directs and coordinates the department's energy program statewide.

**Office Services Section**

This section provides secretarial, administrative and clerical office service support to the Chief Engineering Officer and the various sections in the Engineering Office. Typing, filing, administrative personnel actions, office supply and equipment management, and clerical services are key functional support areas in the implementation of the departmental facilities engineering program, to achieve the program's objectives and fulfill its responsibilities in a timely manner.

Administers, manages, and directs the department's procurement of materials, supplies and services related to janitorial/custodial/grounds maintenance, and automotive repair and maintenance.

**State Motor Pool**

This section provides the full range of field-level overhaul and repair work on all department state automotive vehicles, and other gasoline, diesel and alternative energy powered motorized equipment. Repairs, engine and chassis overhauls, component and systems diagnostics, engine/equipment tests and troubleshooting, procurement and estimates of vehicle and equipment repairs, development of vehicle

and equipment maintenance and replacement plans, and other operational and administrative duties associated with motor pool activities to the department are key functional support areas provided to the department.

**Contracting Services Section**

This section provides the full range of contracting services and support to the various sections and branches in support of the Engineering Office, and to various divisions and offices in support of the department's statewide programs. Contract management and execution for solicitation of professional services, advertisement, bid openings, requests for proposal, construction and goods and services, contract preparation, contract administration, fee negotiations, electronic procurement, fee negotiation, contract supplements, contract file management, state contracting training to departmental personnel and development of contract policies and procedures in compliance with state laws and administrative rules are key functional support areas provided to the department.

**Land Management**

This section provides the full range of land management services to the Engineering Office, and all divisions and staff offices in support of the department's statewide programs. Administers, manages and directs the DOD real property program including the preparation and execution of Use Permits, License and Lease Agreements, Memorandums of Agreements, Memorandums of Understandings dealing with leases, rentals, real estate requirements, land acquisitions and disposals.

**Maintenance Branch**

This branch provides maintenance support services through its General Laborer, Trades, Custodial and Cemetery Burial units, and administers, manages and directs the department's preventive maintenance contracts for all facilities, statewide, which are not managed by the divisions. Janitorial, plumbing, electrical, carpentry, masonry, HVAC, general laborer and cemetery burial operations and services are key functional support areas provided to the department.

**Engineering & Project Management Services Branch**

This branch provides the full range of engineering, project management, construction management, and facility management services to the Engineering Office, and all divisions and staff offices in support of the department's statewide programs.

Provides state-of-the art community based facilities and training facilities, veterans' facilities, cemeteries, emergency operating centers, administration and other miscellaneous facilities that are sustainable and in compliance all applicable rules and regulations. Capital Improvement Program, minor construction, repair and maintenance and job order support, energy conservation and savings program, fire prevention and protection program, master planning, construction plans and engineering report filing, drafting, and engineering and property related policy development are key functional support areas provided to the department.

STATE OF HAWAII  
DEPARTMENT OF DEFENSE  
OFFICE OF HOMELAND SECURITY

Under the supervision of The Adjutant General/Director of Homeland Security, provides direction for the development of a comprehensive Homeland Security program to protect the people and infrastructure from terrorism and threats of an attack.

Develops and recommends policy to The Adjutant General/Director of Homeland Security.

Coordinates critical infrastructure program for the State of Hawaii.

Coordinates policies and procedures to address the increase of the threat advisory based on the National Threat Advisory System.

Coordinates strategic policies and procedures for the state.

Implements and maintains prevention and protection programs across all state organizations for homeland security with state, local and public and private sector.

Coordinates training program for prevention and protection to ensure preparedness against threats of attacks.

Collaborates with other outreach entities to provide prevention and protection measures embracing the whole community.

Coordinates policies and procedures to address cyber security issues by ensuring state and county law enforcement have the capability essential to mitigating successful cyber security efforts.

**GRANTS MANAGEMENT BRANCH**

Through the initiatives established by the Department of Homeland Security coordinate programs, projects, processes with state, county, private sector to reduce the risks of a terrorist attack and to respond effectively to such an attack, or other catastrophe.

Foster collaborative planning and coordination related to security, cyber, communications, law enforcement, search and rescue, HAZMAT, private sector and others to implement the policies and procedures initiated by Department of Homeland Security.

Develop, prioritize and implement mission and functions based governance strategies to integrate processes and systems during each grant phase: Investment; Pre-Award; Award; Post-Award; and Closeout.

Coordinates the Homeland Security/Preparedness Grant programs and other grant initiatives that support reduction of risks and vulnerabilities to the state and Nation.

Coordinates financial processes for the reimbursement/payment of grant programs.

Coordinates monitoring program of programs, processes, procedures of grant programs.

Coordinates funding programs that focus on most critical core capabilities.

Coordinates training program that supports the whole community. Collaborate on the bi-annual Training and Exercise Plan required to support grant programs.

Coordinates the Environmental Historical Preservation requirements for all expenditure of funds.

Implements programs that support reducing the greatest risk and provide the appropriate capability required for response and recovery activities.

Coordinates the means to protect critical infrastructure.

Coordinates Senior Advisory Group to support the Directors priorities, strategic vision, and focus areas related to grant programs, projects, initiatives.

Collaborates the development of the Homeland Security Strategic Plan, the Threat and Hazard Risk Identification Assessment, and other such planning initiatives that support the grant programs.

#### **HOMELAND SECURITY OPERATIONS BRANCH**

Prepares comprehensive plans and programs for homeland security and homeland defense which are integrated and coordinated with state, county, and private sector.

Enhances strategic planning process, mission and functional analyses, identification of capability gaps, measures to close or mitigate capability gaps, resource allocation process, risk analyses, net assessment, modeling capabilities, independent cost analyses, and data collection.

Develops programs that assess the vulnerabilities of critical infrastructure and key resources.

Fosters collaborative planning to maintain advancements in the prevention and protection technologies related to security, cyber, communications, law enforcement, search and rescue, HAZMAT; others as implemented by Department of Homeland Security or other agencies.

Increase community participation in efforts to deter terrorism that engages communities and the whole community.

Provides policy and procedures related to the security of dangerous Chemical, Biological, Radiological, Nuclear materials, weapons and technologies.

Identify, attribute, and evaluate the State's critical infrastructure threats. Enhance the ability of critical infrastructure systems, networks, and functions to withstand and rapidly recover from damage and disruption and adapt to changing conditions by making critical infrastructure resilient.

Develops plans to preserve continuity of government and ensure security at events of national/state significance.

Develop, implement, employ and refine an integrated strategic risk management framework through an annual update to Threat and Hazard Identification Risk Assessment, State Preparedness Report; Bi-annum update of that Homeland Security Strategic Plan.

Coordinates homeland security activities with the county through the Civil Defense Agencies.

Coordinates training and development guidelines for law enforcement and intelligence professionals.

Coordinates credentialing policies and procedures based on Department of Homeland Security.

Coordinates resource typing as it relates to identification of risk and hazard planning.

#### **HAWAII STATE FUSION CENTER**

Provides executive direction and coordination for the State Fusion Center with federal, state, county, private sector nucleus providing the analysis of intelligence.

Collects, gather, analyze and appropriately share intelligence and other information on current and emerging threats. Develop tools, processes and procedures to understand the threat the threat, measure risk, and mitigate the vulnerabilities impacting the state and Nation.

Provides policies and procedures to prevent and deter terrorisms or acts of terrorism.

Implements security clearance program for appropriate state, county and private sector civilian employees.

Through the collection, analysis and information sharing provide guidance on screening and identification verification techniques, the employment of advance detection and other technologies for the protection of harbors and borders.

Prevent the illegal entry of people, weapons, drugs, contraband, and dangerous goods and protect against cross-border threats to health, food, environment, and agriculture, while facilitating the safe flow of lawful travel and commerce.

Identify, evaluate, and prioritize the most dangerous threats to state and private-sector networks.

Coordinates training program for prevention and protection to ensure preparedness against threats of attacks such as the Suspicious Activity Reporting.

Obtaining/maintaining minimum national baseline Fusion Center standards for certification.

#### **CYBERSECURITY BRANCH**

Collaborate with a multitude of agencies (such as the University of Hawaii, private businesses, public sector entities and government agencies) to coordinate efforts and recommend improvements to the State's cybersecurity and cyber resiliency.

Develop through various partnerships and collaborations, requirements and methods to improve the State's critical infrastructure network.

Assist to accelerate the growth of the State's cybersecurity industry.

Form partnerships to implement cyber resiliency structures and protocol to identify and share information about possible cyber-attacks, and develop effective responses to such attacks.

**STATE OF HAWAII  
DEPARTMENT OF DEFENSE  
HAWAII ARMY NATIONAL GUARD DIVISION**

The Hawaii Army National Guard (HIARNG) is responsible to provide trained units to achieve the highest level of readiness in order to prepare individuals and units to perform effectively. They are expected to dominate across the full spectrum of unified land operations to fulfill its federal and state missions to protect, support and defend the state of Hawaii, United States of America and U.S. national interests. The HIARNG provides ready units and agile citizen-soldiers to respond to the state and country's call for protection, support and defense.

**Clerical Services**

Clerical services provides clerical and office support services to the HIARNG administration and all other sections as needed. Office services provided may include making appointments and setting up meetings, logistical support for setting up meeting rooms, maintaining files and records, receive and respond to a variety of inquiries or requests for information, reception services for visitors and dignitaries, and other related clerical services.

**G1 Personnel (Federal)**

Exercises staff responsibility for all matters pertaining to administration of officer and enlisted personnel of the Hawaii Army National Guard to include military personnel procurement, record-keeping, morale, medical care, discipline, automated personnel reporting systems, bonus programs, and maintenance of strength in preparing units of the Hawaii Army National Guard to meet their Federal and State mobilization requirements.

**G3 Planning and Operations (Federal)**

Responsible for all matters pertaining to plans, operations, and training of units of the Hawaii Army National Guard to meet their federal and state mobilization missions.

**G4 Logistics**

Responsible for all matters pertaining to supply, maintenance, transportation, and services in preparing units of the Hawaii Army National Guard to meet their Federal and State mobilization missions. Exercises staff supervision for all matters pertaining to field and sustainment level maintenance performed by the various units, Field Maintenance Shops (FMS), Unit Training and Equipment Site (UTES), and Combined Support Maintenance shops (CSMS).

**G6 Information Management**

Provides command, control, communications, computers and information management (C4IM) services to the HIARNG to train, support, mobilize, and deploy forces in support of our Nation, State and Community. Provides integrated sustaining base information services, support and products. Protects and defends the Army's systems, networks and information. Technical proponent for strategic and tactical communications systems.

**Construction and Facilities Management Branch**

the Construction and Facilities Management Branch (CFMB) provides engineering operations; construction project management; engineering plans and services; buildings, structures and grounds sustainment, restoration and modernization; custodial services; fire and emergency services; pest control; preventive maintenance programs; improved and unimproved grounds services; public works budgeting, accounting, energy management, and resources management; environmental services; and other public works activities to include utilities and municipal services. The CFMB consists of seven subordinate organizations: Office Services, Contract Management, Facilities Management Section, Resource Management Section, Design & Project Management Section, Environmental Office, and Planning and Programming Section.

**Office Services**

Office Services provides clerical and office assistant services to the Construction & Facilities Management Officer and the other six sections as needed.

**Contract Management Section**

Develops, staffs, and executes contract agreements and business management services to comply with Federal and State Law and Chief Financial Officer Act (CFOA). Contract agreement types include



Memorandum of Agreement (MOA), Memorandum of Understanding (MOU), Military Construction Cooperative Agreements (MCCA), Inter-service Support Agreements (ISSA), and Military Interdepartmental Purchase Request (MIPR). Responsible to process, staff and action requests for short term out-grants of facilities use by other governmental, and not for profit on both Federal and State property. Creates and staffs for approval SRM project authority forms (NGB Form 420-R), National Environmental Policy Act (NEPA) documents and keeps official project records files electronically and paper copies for audits to be used in conjunction with Facility Information Folders (FIF) audits.

#### Facilities Management Section

Facilities Management, which activities are federally funded within the MCA appendix 1001 on facilities identified as eligible for federal support on the Facilities Inventory and Support Plan (FISP). Responsibilities include preventative maintenance, sustainment repair, and demolition. First point of contact relative to facilities maintenance requirements at each of the established locations to include Kauai, Oahu, Maui, Molokai and the Big Island of Hawaii. Through MCA appendix 1004, maintains and monitors Electronic Security Systems (ESS) Equipment and manages ESS projects. Responsible for Installation Status Report (ISR) – Installations reporting and inspections. Provides facilities operations support to the Hawaii Army National Guard. Facilities Management includes two subordinate sections: Facilities Maintenance, and Electronic Security Systems. Responsible Facilities Maintenance to develop repair and maintenance projects internal designs, scope of work, specifications and drawings. Use state procedures for procurement. Provide full spectrum project management on all maintenance, repair, and demolition projects. Conduct building forensic troubleshooting. Oversee repair and maintenance project execution and completion.

#### Electronic Security Systems

Responsible for budgeting, design, supply, installation, maintenance, inspection, and use of electronic security and surveillance systems. Provides knowledge of design and construction techniques and standardized NGB-compliant best practices. Provides expertise, tools and equipment for field installation, repairs, maintenance, and fully-operational electronics shop for component repairs and maintenance. React to any Intrusion Detection System (IDS) problem within 24 hours of notification by users.

#### Resource Management Section

Public Works Resource Management, which includes financial planning, programming, budgeting, budget execution, accounting and review activities. Resource Management is responsible for all federal budgeting and accounting coordination between the State and Federal accounting offices and with ARNG-ILI with respect to budgeting for MCA appendixes 1001, 1002, 1004 and 1007. Provides service management to include grounds, custodial, pest management contracts, and solid waste management. Supports range budgeting and maintenance management functions. Coordinates energy management data collection and project planning requirements. Compiles budget information for both Federal and State Allotment requests. Validates and processes federal reimbursement requests from the State. Collects and reports data with respect to Energy, Water, Solid Waste and Recycling for federal reporting.

#### Design and Project Management Section

Provides complete project management, from planning to construction phases and warranty periods, for all projects requiring contract design services to include repair, minor construction and all Military Construction National Guard (MCNG) projects involving federal and state funding. Responsible for management of State Capital Improvement Program (CIP) for HIARNG projects including preparation of legislative appropriation and allotment requests, preparation and tracking of budgets and expenditures for planning, design, construction, and equipment. Project management to include both State and Federal contracting procedures, user coordination, design reviews, permitting, quality assurance surveillance, project periodic inspections and evaluation of contractor performance. This section is also responsible for Energy Management. Collect and record electrical, water, and sewer use data in the Federal reporting system. Plans and justifies energy saving projects, planning for 5-7 years. Conducts Life Cycle Cost Analysis estimates for energy projects.

#### Environmental Office

The Hawaii Army National Guard (HIARNG) Environmental Office is responsible for all environmental activities funded within the cooperative agreement appendix 1002 on facilities identified on the FISP. The HIARNG is responsible for complying with Presidential Executive Orders, Department of Defense Instructions, Army Regulations, Federal, State, and local regulations pertaining to the environment. The Environmental Office (ENV) supports these requirements and is committed to sound environmental stewardship that involves preventing pollution, protecting the water, air and land, complying with all

laws and requirements, preserving natural and cultural resources and ultimately working towards the goal of sustainability. ENV coordinates with State, federal and local environmental regulatory agencies and the National Guard Bureau (NGB) Environmental Division, serves as subject matter experts (SME) and is responsible for providing for providing technical advice statewide on HIARNG activities, construction projects and training. ENV also advises on project plans, designs and Scopes of Work (SOWs) as well as proposes, develops and implements SOWs for projects and activities to address environmental issues and requirements. ENV has three (3) programs: Compliance, Conservation, and Training & Administrative Support.

#### Compliance Unit

Planning, implementing, coordination, monitoring and managing of all applicable, current and updated environmental compliance requirements and related programs within HIARNG facilities/sites statewide, which includes, but is not limited to, the management of hazardous materials and waste, solid waste management, air quality, water quality, noise quality, toxic substances (as defined by the Toxic Substances Control Act (TSCA), site/facility corrective action/restoration/cleanup, Environmental Planning and Community Right-to-Know Act (EPCRA) documentation and reporting, Environmental Management System (eMS), pollution prevention (P2), waste minimization (WM) and recycling. Additionally, the compliance section is responsible for planning and conducting of Internal Environmental Performance Assessment System (EPAS) audits of HIARNG facilities, units and activities (elements), recording/documenting of all HIARNG Internal EPAS audit findings. Further, the Compliance Branch is responsible for coordinating and is the point of contact (POC) for NGB in the conducting of External EPAS audits of HIARNG elements and assists HIARNG in correcting and closing all External EPAS audit findings.

#### Conservation Unit

Ensures HIARNG's compliance with and implements conservation laws and regulations including, but not limited to , the National Environmental Policy Act (NEPA); Environmental Condition of Property (ECOP); Endangered Species Act (ESA); Sikes Act; Migratory Bird Treaty Act; Executive Order (EO) 13112 Invasive Species; EO 13186 Responsibilities of Federal Agencies to Protect Migratory Birds; EO 11990 Protection of Wetlands; DoDI 4715.03 Natural Resources Conservation Program; National Historic Preservation Act (NHPA); Archaeological Resources Protection Act; Native American Graves Protection and Repatriation Act (NAGPRA) EO 13007 Indian Sacred Sites; EO 36 CFR 79 Curation; DoDI 4710.03 Consultation Policy with Native Hawaiian Organizations; Federal Insecticide, Fungicide and Rodenticide Act (FIFRA); DoDI 4150.7 DoD Pest Management Program; Hawaii Pesticides Law (HRS 149A); Coastal Zone Management Act (CZMA); AR 350019 Sustainable Range Program; Integrated Training Area Management (ITAM).

#### Environmental Training and Support Unit

Managing the resources provided by the National Guard Bureau (NGB) and various outside sources and entities for environmental projects. Coordinates training and provides training schedule and materials to our Hawaii National Guard members for environmental education and awareness. Provides support in program management, logistical planning, budgeting and finance, contracting and administration for this program. Support the program with day to day operations such as composing of environmental correspondences and memorandums, organizing project files and records, procurement of supplies and services, arrangement of travel, time and attendance of employees.

#### Planning and Programming Section

Planning and Programming is responsible for real property accountability and accuracy of the FISP, and supporting FIF files required by CFOA. Coordinate real estate actions to include lease, license and permit for both Federal and State land acquisitions and disposals. Service data validation requirements for several Federal planning systems. Provide Integrated Geospatial Data Services to support CFMO, Environmental, and HIARNG G3 Operations. Provides facilities based master planning services to validate requirements. In regards to Installation Geospatial Information Systems, Planning and Programming is responsible for full spectrum Geographic and Geospatial Information System development and maintenance with respect to all buildings and structures located on Federal or State lands leased, licensed, permitted or granted to the HIARNG as recorded in the FISP. Provide systematic approach in creating, maintaining and managing geospatial information and services in support of the installation, environment and sustainable range program requirements. This section is also responsible for Master Planning, a full spectrum master planning services with respect to the HIARNG units and the FISP. Facilitate a continual, collaborative and integrated master planning process that adheres to Army real property master planning policy and guidance, and supports the TAG vision and installation's

current and future missions. Create, staff, finalize, and update annually all MCNG congressional budget documents (DD Form 1390/ 1391).

#### **Army Aviation**

Responsible for all matters pertaining to the Army Aviation program to include administration, maintenance, individual aviator flight training, and flight safety in preparing aviation units of the Hawaii Army National Guard to meet their Federal and State missions. Manages both Army Aviation Support Facilities #1 and #2 to provide oversight to assigned aviation units under all environmental conditions.

#### **Safety Office**

Preserve the capabilities and enhance the HIARNG force by providing a safe and healthy environment for soldiers, families, civilians and contractors by developing a culture where safety and occupational health are enablers of HIARNG readiness and quality of life.

#### **Recruiting and Retention Battalion**

Responsible for HIARNG's annual recruiting and retention mission of enlisted, officers, warrant officer accessions within the State of Hawaii. This Battalion is responsible to support all subordinate commanders and their units in recruiting members to fill valid vacancies and retain the best and brightest soldiers in the HIARNG. Conducts the Recruit Sustainment Program (RSP) at the Regional Training Institute in Waimanalo, Oahu. This program is the formal process for indoctrinating and preparing civilians for successful completion of their Initial Entry Training (IET) or Basic Training courses and is a top performing program.

#### **G2 Intelligence (Federal)**

Responsible for all matters related to plans, missions and capabilities of intelligence and intelligence-related organizations and units. Includes responsibilities related to programs, proposals, activities, personnel intelligence training, and other intelligence functions.

#### **G8 Finance**

Responsible for the planning, coordination, policies and functions pertaining to programming, budgeting, management studies, and manpower management support to U.S. forces. Staffed by military and civilian personnel, responsible to provide resource management support services.

#### **HQ Detachment, Joint Force Headquarters**

Provides personnel administration, training and logistics support to the Headquarters. Its mission is to empower service members, retirees, veterans and their families to support their resiliency and growth by providing education, resources, and assistance for the unique environment of today's military way of life.

#### **Office of the State Surgeon, Medical Detachment**

The Office of the State Surgeon (OTSS) and Medical Detachment plan, program, provide and sustain health force protection and health support services to meet operational, training and mobilization requirements of the Hawaii Army National Guard units and soldiers.

#### **29<sup>th</sup> Infantry Brigade Combat Team (IBCT)**

Provides command, control, supervision, coordination, administration, logistics, and staff planning of the operation of the brigade and attached units for its Federal and State mobilization mission. When mobilized, its mission is to deploy ready forces to conduct decisive actions in support of domestic or overseas missions to protect, support and defend our state and nation. Subunits within the 29<sup>th</sup> IBCT are the 1<sup>st</sup> Battalion, 299<sup>th</sup> Cavalry Squadron in Hilo, Hawaii; the 1<sup>st</sup> Battalion, 487<sup>th</sup> Artillery in Wahiawa, Oahu; the 29<sup>th</sup> Support Battalion in Kalaeloa, Oahu and the 277<sup>th</sup> Brigade Engineer Battalion in Kalaeloa, Oahu. This is the largest HIARNG unit, who is headquartered at Kalaeloa, Oahu.

#### **103<sup>rd</sup> Troop Command**

Provides ready forces to support federal and state missions, and provide mission command during National Guard domestic events. This Command is headquartered at the Waiawa Armory in Pearl City,

Oahu. The subunits include the 111<sup>th</sup> Army Band and 117<sup>th</sup> Mobile Public Affairs Detachment in Waiawa; the 230<sup>th</sup> Engineer Company at the Puunene Armory in Kihei, Maui; the 297<sup>th</sup> Engineer Detachment Fire Fighting Team in Waiawa; Company B, 777<sup>th</sup> Aviation Support Battalion and Company B, 1<sup>st</sup> Battalion, 171<sup>st</sup> Aviation both on Wheeler Army Airfield; Company C, 1<sup>st</sup> Battalion, 207<sup>th</sup> Aviation and Detachment 1, Company A, 3<sup>rd</sup> Battalion, 140<sup>th</sup> Aviation Regiment both in Hilo, Hawaii; and Company B 1109<sup>th</sup> Theater Aviation Sustainment Maintenance Ground and 1950<sup>th</sup> Contingency Contracting Team both in Waiawa, Oahu.

**298<sup>th</sup> Regional Training Institute (RTI)**

The RTI trains soldiers and leaders of the U.S. Army National Guard, active duty and reserve components to the standards set forth by the United States Army Training and Doctrine Command (TRADOC), provides them the resources and knowledge to train to standards and lead effectively in all circumstances, and provides specific MOS-qualifying materials and engagement scenarios to support the Hawaii Army National Guard and Department of Defense unified land operations.

STATE OF HAWAII  
DEPARTMENT OF DEFENSE  
**HAWAII AIR NATIONAL GUARD DIVISION (HIANG)**

Directs and coordinates the activities and units of the State Department of Defense Air National Guard Division. The HIANG has dual Federal and State missions. In the Federal role, the HIANG provides trained and qualified personnel for active duty in time of war or national emergency. In the State role, the HIANG provides organized and trained units to protect Hawaii's people, preserves peace, and ensures public safety in response to natural and human-caused disasters.

**Operations Staff**

Provides Military Staff Office, Operations and Training services to support the Commander and other HIANG programs.

**Administrative Staff**

Provides administrative, personnel and recruiting assistance to the HIANG to support the Commander and other programs to maintain its state and federal missions.

**Headquarters 154<sup>th</sup> Wing**

Provides overall command direction, planning, staff supervision and management of the 154<sup>th</sup> Wing in fulfilling its prescribed missions of providing forces to support air defense, air superiority, air refueling, and airlift missions for both the Federal government and the state of Hawaii. Additionally, the 154<sup>th</sup> Wing provides highly skilled and equipped personnel to support the State in the recovery from man-made and natural disasters. These missions include manning key positions in the Hawaii National Guard Emergency Operations Control Center, as well as providing airlift, medical, communication, engineering, and security police forces required for disaster response.

**154<sup>th</sup> Operations Group**

Provides overall command direction, planning, staff supervision, and management of the 154<sup>th</sup> Group flying operations in support of Federal and State missions.

**199<sup>th</sup> Fighter Squadron**

Provides trained aircrews with mission capability to execute fighter missions required to identify aircraft and destroy enemy forces. Provides air sovereignty for the State of Hawaii that is worldwide deployable to meet wartime and peacetime requirements.

**203<sup>rd</sup> Air Refueling Squadron**

Provides a unit trained in aerial refueling in support of full spectrum in-flight air refueling and strategic airlift for peacetime, war, and contingency requirements. Supports tactical, mobility, and strategic operations at both the Federal and State levels.

**204<sup>th</sup> Airlift Squadron**

Provides trained aircrews with mission capability to meet Federal and State airlift requirements, including tactical and theater airlift in either peacetime, full spectrum conventional warfare, or during State of Hawaii emergency and disaster response efforts.

**201<sup>st</sup> Intelligence Squadron**

Processes, exploits and disseminates ISR data and provides AF National Tactical Integration to 613 Air and Space Operations Center

**169<sup>th</sup> Air Defense Squadron**

Provides continuous operation and maintenance of an air defense facility and associated sensor sites that give the state of Hawaii and the nation early warning defense capability to protect Hawaii's skies from enemy attack. Collects, displays, and evaluates information on air activities within surveillance capabilities. Directs fighter interceptor and aircraft engaged in intercepting assigned targets. Assists the State in responding to emergencies by providing fixed communications and power production equipment.

**297<sup>th</sup> Air Traffic Control Squadron**

Provides air traffic control services for United States Air Force wartime and contingency requirements, as well as state of Hawaii disaster-recovery efforts.

**154<sup>th</sup> Operations Support Squadron**

Supports all elements of the 154<sup>th</sup> Wing flying operations. Provides a staff function, knowledgeable in all aspects of weapons and tactics, intelligence, operational planning, ground-based command and control systems, and current operations. Provides full spectrum expertise and support for key aspects of all Group-flying missions.

**199<sup>th</sup> Weather Flight**

Provides 24-hour-a-day meteorological services to a U.S. Army infantry brigade and is capable of rapidly deploying to meet Federal and State emergency requirements. Capabilities include weather forecasting support for airfields, drop zones, and helipads.

**154<sup>th</sup> Maintenance Group**

Maintains overall command direction, planning, staff supervision, and management of all logistics missions in support of Federal and State operational missions. Functions include aircraft maintenance, cargo marshaling and loading; contracting services, supply accounts, and vehicle operations and maintenance.

**154<sup>th</sup> Maintenance Squadron**

Provides a highly-trained unit supporting all Federal and State 199<sup>th</sup> Fighter Squadron operational missions by maintaining aircraft, munitions, and aerospace and ground equipment.

**154<sup>th</sup> Aircraft Maintenance Squadron**

Provides direct maintenance support to the 199<sup>th</sup> Fighter Squadron, 203<sup>d</sup> Air Refueling Squadron and 204<sup>th</sup> Airlift Squadron.

**154<sup>th</sup> Maintenance Operations Flight**

Supports all elements of the Logistics Group maintenance and supply functions for aircraft and associated systems.

**154<sup>th</sup> Mission Support Group**

Provides overall command direction, planning, staff supervision and management of support missions in support of Federal and State operational missions. Functions include security, engineering, food and mortuary services, telecommunications, and personnel.

**154<sup>th</sup> Civil Engineer Squadron**

Provides a highly mobile, self sufficient, rapidly deployable civil engineering capability. Trained personnel provide runway, facility, and utility damage assessment and repair teams. Civil engineering personnel are adept in construction, water purification, and tent city planning. The 154<sup>th</sup> Civil Engineer Squadron conducts recovery operations in hostile and peacetime environments. Unit personnel are qualified to deploy anywhere in the world within 28 hours and are fully trained to respond to State of Hawaii natural or man-made disaster response operations.

**154<sup>th</sup> Logistics Readiness Squadron**

Provides direct support for all units assigned to the HIANG. Management services include fuels distribution, traffic management, vehicle operations and maintenance, and base level contracting. The unit is able to support Federal missions, Hawaii emergency missions, and is worldwide deployable to meet contingency requirements wherever they occur.

**154<sup>th</sup> Security Forces Squadron**

Provides a highly trained and qualified unit available to provide security services for tactical aircraft, command and control centers, munitions, and air defense areas to meet both Federal and State requirements.

**154<sup>th</sup> Force Support Squadron**

Provides human resource management and personnel accountability functions supporting all Federal and State missions of the HIANG. Specific functions include recruiting, career progression, education and training, and personnel processing.

**154<sup>th</sup> Communications Flight**

Provides a highly-qualified unit to furnish ground communications, information management systems, and photographic documentary capability in support of all HIANG missions and units.

**291<sup>st</sup> Combat Communications Squadron**

Provides a highly trained and qualified unit to provide command and control communications for both Federal and State mission requirements. Capabilities include land line, satellite and secure communications, as well as operating portable and mobile multi-band radios, and delivering on-scene command and control.

**292<sup>nd</sup> Combat Communications Squadron**

Provides a highly trained and qualified unit to provide command and control communications for both Federal and State mission requirements. Capabilities include delivering landline, satellite, and secure communications, as well as operating portable and mobile multi-band radios, and delivering on-scene command and control.

**293<sup>rd</sup> Combat Communications Squadron**

Provides a highly trained and qualified unit to provide command and control communications for both Federal and State mission requirements. Capabilities include landline, satellite and secure communications, operation of portable and mobile multi-band radios, and on-scene command and control.

**154<sup>th</sup> Medical Group**

Provides a trained unit of qualified medical personnel providing medical and dental services to the HIANG. This unit is deployable to meet medical requirements of Federal missions and State disaster response efforts.

**109<sup>th</sup> Air Operations Group (AOG)**

Provides classic associate units that augment the Pacific Air Forces' 613<sup>th</sup> Air and Space Operation and the Air Mobility Division to support the maintenance of command and control of real-world air, space and cyber operations. The 109<sup>th</sup> AOG operates to meet the U.S. Pacific region strategies and to assist in humanitarian aid and disaster relief operations. Personnel include pilots, navigators, weapons controllers, flight nurses, intelligence specialists, network strategists and cyber operators.

**STARBASE HAWAII**

Provides the U.S. Department of Defense program that targets disadvantaged youth in rural areas or inner cities to provide exposure to Science, Technology, Engineering and Math (STEM) fields of study. The targeted age group is the 5<sup>th</sup> grade whose students are provided a mix of lecture and hands-on STEM materials for a week-long session to engage in and encourage interest in these fields of study.

**HAWAII EMERGENCY MANAGEMENT AGENCY**

The Hawaii Emergency Management Agency (HI-EMA) assists the Hawaii OHANA to prepare for, respond to and recover from disasters.

**OFFICE OF THE ADMINISTRATOR**

Under the supervision of the Adjutant General/Director of HI-EMA, the Administrator provides direction, control and coordination of agency responsibilities and functions and assumes the role of the Director of HI-EMA in his absence.

Develops and recommends policy to the Director of HI-EMA and the Governor.

Administers and directs HI-EMA in planning, programming, preparing, organizing, and training for the purpose of minimizing loss of life and property within the state due to man-made and natural disasters.

Coordinates the activities of the four county emergency management/civil defense agencies.

Coordinates statewide preparedness planning with state agencies, resident federal agencies, non-profit organizations and the private sector.

Carries out policies of and makes recommendations to the Federal Emergency Management Agency (FEMA).

Programs for and acts as a pass-through office for Federal funds in support of state and county emergency management/civil defense programs and federal disaster assistance programs.

Negotiates contracts with federal agencies and administers their execution.

Plans, programs, and executes the agency's budget. Reviews and prepares relevant legislation for submission to the legislature. Directs the installation and management of the agency's computer system; plans, programs, installs and maintains emergency management automated data systems.

Provides executive direction and coordination of the State Emergency Operation Center (SEOC) when the agency is activated and directly supports the Governor and counties in managing the total resources of the State, formulating and carrying out disaster relief, and coordinating and directing all government, business and individual actions and activities statewide upon declaration of an emergency or disaster.

**PACIFIC DISASTER CENTER (PDC) LIAISON OFFICER**

Advises the Administrator on all matters pertaining to the Pacific Disaster Center (PDC) and coordinates all PDC support to HI-EMA and applicable partner agencies.

Plans, directs, and manages all aspects of the PDC program as pertinent to the HI-EMA and partner agencies.

Identifies, proactively anticipates, and addresses customer support issues, communicates PDC recommendations and capabilities, and ensures follow up on PDC performance.

Communicates mission requirements to PDC regarding products and services applicable to various emergency management /civil defense requirements and emergency management activities.

**EXECUTIVE OFFICER**

Acts primarily as the deputy to the Administrator of HI-EMA and coordinates the administrative responsibilities within the agency, including budgeting and personnel functions. In the absence of the administrator, the executive officer assumes all duties and authorities of the administrator.



**SECRETARIAL STAFF**

Supports all office administration and scheduling requirements of the Administrator's office.

**EXTERNAL AFFAIRS SECTION**

Advises the Administrator on all matters pertaining to public affairs and outreach.

Plans, programs, and directs disaster public information and education programs to condition the population to respond intelligently to threats of disaster and standardized warning signals.

Coordinates emergency public information and education with state and county officials, the media and other private organizations; observes and studies trends in public opinion; publishes and distributes newsletters; maintains film and reference library; and distributes informational emergency publications to the public.

Maintains and trains volunteer outreach staff personnel.

**PREPAREDNESS BRANCH**

The Preparedness Branch supports HI-EMA's mission by working with all sectors through the Planning, Training, Exercise, Hazard Mitigation, Hurricane, Earthquake/Tsunami, Infrastructure, and Citizen Corps sections and units. The sections/units work with all levels of government, the private sector and non-profit organizations to implement their programs, in order to ensure Hawaii is as prepared as possible to meet all disasters and to recover as quickly as possible.

Advises the Administrator on all matters pertaining to emergency management training, exercises, education, and planning, and the mitigation, hurricane and earthquake programs.

Analyzes emergency management training needs throughout the state and establishes training goals, plans and programs; develops training courses; promotes and monitors county emergency management and civil defense agencies and state department programs of instruction; reviews and evaluates accomplishments; and supports training for public and private organizations.

Coordinates and provides professional emergency management, including exercises, for state and county government officials and industry, and coordinates technical emergency management training.

Develops and implements an accelerated preparedness response and training program to supplement and extend the capabilities of the state's emergency government in the event of an increased readiness operation or declaration of an emergency/disaster and activation of the State EOC as the nucleus of an emergency state headquarters in direct support of the Governor and counties.

Coordinates, guides, and assists the counties in the development and maintenance of county community emergency shelter programs, crisis relocation and emergency resources management plans to include supporting training programs.

Establishes training programs for reserve military officers attached to the Hawaii Emergency Management Agency and directs the activities of officers assigned to the branch.

Develops and maintains plans for the relocation of state government, succession to authority of State officials and emergency utilization of State employees, facilities and other resources.

**PLANNING SECTION**

Oversees the development and maintenance of plans for response and recovery actions for all types of emergencies; develops plans and procedures to alert key officials of both public and private sectors and to warn the public in the event of the threat or occurrence of an emergency or disaster.

Supervises and provides technical assistance to county and State agencies in the development and maintenance of emergency response plans.

Reviews county and state agency emergency response plans to ensure currency and compatibility with state plans and federal requirements.

#### TRAINING UNIT

Supports the preparedness mission of the division by coordinating training activities across the state and for all levels of government, the private sector and non-profit organizations.

Conducts assessments to determine training needs and to establish training priorities. Facilitate training conferences and develop an annual statewide training plan. Coordinate courses sanctioned by the National Training and Education Division (NTED) of the Federal Emergency Management Agency (FEMA) for professional training and development.

Provides training administration through technical assistance in course development, coordination, and assisting in the actual conduct and presentation of emergency preparedness training for the State of Hawaii, to include developing and implementing the Emergency Management Training Program and National Incident Management System (NIMS) training program in Hawaii.

Develops, maintains and manages a training work plan and schedule for the Emergency Management Training program, to include staff training of HI-EMA, State departmental training for Civil Defense Coordinators (CDCs) and State Emergency Response Team (SERT) members.

Coordinates emergency management and first responder training for county civil defense agencies and City & County of Honolulu Department of Emergency Management (DEM) including personnel from fire, police, emergency medical service, and public works.

Coordinates, plans and schedules emergency preparedness training with non-government organizations, faith-based organizations, private sector, and volunteer groups, etc. statewide. Foster public awareness activities to promote mitigation and preparedness programs at community fairs, town hall meetings, conferences and summits.

Manages the training program budget and related Federal grants. Track expenditures and prepares/submits financial documents as required. Prepare contracts and/or memorandum of agreements (MOA); solicit bids; execute procurement processes and procedures.

#### HAZARD MITIGATION SECTION

Advises the Administrator on all matters pertaining to the hazard mitigation program.

Develops, maintains, and administers the State Multi-Hazard Mitigation Plan which enables the State and counties to prepare for, respond to, and recover from threats posed by natural hazards and mitigate the effects of future disasters on people and property.

Develops and maintains liaisons with federal and local government, county departments, and similar entities to facilitate plan development and response effort coordination.

Proposes updates to, and/or modifications of, emergency response procedures based on regulatory changes, technological changes, or knowledge gained from the outcomes of previous emergency situations.

Collaborates with other officials to prepare and analyze damage assessments following disasters or emergencies.

Assists eligible persons, communities, and organizations in applying for emergency management and hazard mitigation grants.

Applies for federal grants for emergency management related needs and administers and reports on the progress of such grants.

Attends meetings, conferences, and workshops, both on and off island, related to emergency management to learn new information and to develop working relationships with other emergency management professionals.

Prepares emergency situation status reports that describe response and recovery efforts, needs, and preliminary damage assessments.

Consults with officials of local and county governments, schools, hospitals, and other institutions to determine their needs and capabilities in the event of a natural disaster or other emergency. Studies emergency management plans used elsewhere to maintain situational awareness and stay abreast of best practices.

#### EXERCISE UNIT

Supports the preparedness mission of the division by coordinating disaster response exercises across the state and for all levels of government, the private sector and non-profit organizations.

Develops, implements, and coordinates Hawaii's Emergency Management Exercise Program. Assist in the exercise design and development process including identifying objectives, designing the scenario, creating exercise documents, coordinating logistics, planning exercise conduct, and selecting an evaluation and improvement methodology. Conducts exercise/training conferences and coordinate courses for professional training and development.

Conducts studies and integrated analysis to support exercise evaluation and foster improvements and corrective actions to State emergency operations plan. Provide recommendations to the Training and Exercise Section Chief on the Statewide Exercise Program development, implementation and strategy.

Maintains communication with various government entities including the military, members from the private sector and non-government organizations to promote preparedness exercises. Coordinates onsite field support to local officials and other response personnel in support of State exercise programs. Consults and advises public and private officials in interpretation of Federal and State exercise planning guidance and other required information.

Manages the exercise program budget and/or exercise related Federal grants, including preparation and submission of financial documents.

Provides technical assistance in the development of requisite exercise materials including work plans, scenarios and other related materials. Support major exercises presented by State and local government. Coordinates training activities related to exercise design, development and improvement planning. Monitors the exercise program phases including foundation, design and development, conduct, evaluation and improvement planning.

#### NON-GOVERNMENTAL (NGO)/PRIVATE SECTOR UNIT

Provide technical assistance and organizational skill to the Hawaii State chapter of Voluntary Organizations Active in Disasters (HS-VOAD), ensuring they are prepared to support the citizenry in the aftermath of disasters.

Provide the primary conduit to private businesses and business organizations throughout the state. Seek out opportunities for HI-EMA staff members to address businesses and business organizations on personal and business readiness activities.

Encourage communities to develop resiliency by scheduling/conducting presentations at neighborhood board meetings, community associations and regional readiness fairs.

#### LOGISTICS/CRITICAL SYSTEMS SECTION

Advises the Administrator on all matters pertaining to hurricane preparedness planning regarding logistics and critical systems necessary to recover from disasters and emergencies.

Works with county emergency management/civil defense agencies to identify state and county facilities capable of withstanding, or being retrofitted to withstand, the likely impacts of combined tropical cyclone effects and to develop contingency plans to make the best of these structures/facilities as tropical cyclone shelters.

Evaluates the likely impact of approaching tropical cyclones to include the effects of high wind, storm surge and flooding, on emergency services and lifeline functions required to support evacuation, sheltering, emergency health and medical, and mass care operations.

Develops materials and conducts outreach activities to assist individuals and organizations prepare for disasters and emergencies.

#### NATURAL HAZARDS SECTION

Advises the Administrator on all matters pertaining to natural hazards preparedness planning.

Develops and maintains the natural hazards program to prepare, mitigate, and minimize the effects of natural disasters on people, property and builds capacities to improve community resilience.

Applies for and manages grants designed to support the natural hazards programs to include the development and receiving of proposals, also management, monitoring, and review of projects utilizing grant funds that enhance programs.

Maintains and facilitates the supporting scientific groups - Tsunami Observer Program, Hawaii Earthquake and Tsunami Advisory Committee (HETAC), Weather Impacts Advisory Committee (WIAC), and the Tsunami Advisory Group.

Represents Hawaii at Federal level focus groups such as National Tsunami Hazard Mitigation Program, National Earthquake Hazards Reduction Program, Western State Seismic Policy Council, Earthquake Engineering Research Institute, and the Tsunami Ready program.

#### INFRASTRUCTURE ENGINEER UNIT

Advises the Preparedness Branch on matters pertaining to shelter infrastructure. Responsible for managing the daily activities associated with identifying and evaluating suitable evacuation shelters for residents and visitors to the State of Hawaii.

Manages funds provided for these activities and provides assistance to County, State and private organizations in the development and maintenance of evacuation shelters.

#### OPERATIONS BRANCH

The Operations Branch supports the Division's mission through the Current Operations, Future Operations, and Disaster Assistance Sections. These segments monitor and issue warnings, oversee the State Emergency Operations Center and train response staff, and implement federal disaster relief programs, respectively.

Advises the Administrator on matters pertaining to emergency management, response and recovery operations, mass care and resource mobilization.

Assists the Director in preparing reports to the Governor that pertain to emergency management.

Maintains interagency liaison and communication among emergency management, state and federal agencies, county governments and non-governmental agencies to include professional organizations and community groups concerned with disaster prevention and mitigation.

#### CURRENT OPERATIONS SECTION

Establish and staff a warning point to monitor all situations that might affect Hawaii; provide warning to the people of Hawaii; initiate recall procedures for the Hawaii Emergency Management Agency and the State Government, as required; and maintain the status of locations of various state officials. Provide updated information for the Governor concerning possible threats or events that may affect his official travel schedule.

Organize and train the Emergency Response Teams (ERTs); direct the activities of the ERTs during an activation of the State Emergency Operations Center for a pending or active threat to the state.

**FUTURE OPERATIONS SECTION**

Plans, directs, and manages the operation of the State Emergency Operations Center (SEOC); activates the SEOC as required for drills and emergencies; and activates alternate SEOCs as required.

Establishes and maintains liaison with federal agencies, including the military forces, and coordinates their emergency management activities with the state.

Coordinates operational activities among county, state, federal and private agencies and individuals responding to an imminent or actual disaster. Provides leadership and supervision in the field, as requested by the Counties, during disaster situations to facilitate the implementation of effective response and recovery activities.

Reviews and evaluates mutual aid agreements and statements of understanding that state and county departments make with each other and with federal and private organizations capable of providing public or individual relief or assistance.

Plans and directs staffing patterns to support routine and emergency operations in the SEOC as required.

**DISASTER ASSISTANCE SECTION**

Advises the Administrator on matters pertaining to the Public Assistance (PA) and Individual Assistance (IA) Programs and mass care.

Oversees the public assistance program within the State; develops and distributes policies and administrative procedures to support the program; acts as an advocate for applicants in dealing with FEMA; manages federal funds for disaster recovery.

Oversees recovery activities for disasters; hires temporary exempt staff as needed to support the needs of the state during the recovery phase.

Oversees the individual assistance program within the State; develops and distributes policies and administrative procedures to support the program; develops plans for supporting the counties and the population with Disaster Recovery Centers.

Provides assistance to county and State agencies in the development and maintenance of disaster assistance and recovery administrative procedures.

**TELECOMMUNICATIONS BRANCH**

The Telecommunications Branch supports the Division's mission through the Information Technology (IT), Communications and Warning, and EOC Support Sections. These segments install, oversee and maintain statewide emergency communication systems.

Advises the Administrator on the application of communications-electronics systems to emergency management planning, system design, installation and maintenance, procurement specifications and contracts, operational matters, management, and decision-making.

Prepares, reviews, and coordinates plans, policies and programs which pertain to the organization, training, testing, operations and equipment of the Hawaii Emergency Management Agency communications and warning systems.

Plans, directs, and supervises the acquisition, installation, operation, maintenance, and improvement of the Hawaii Emergency Management Agency telecommunications-electronics systems and equipment statewide to include warning systems. Provides technical staff assistance and direction as required.

Plans and oversees the State Emergency Alert System, and implements Common Alerting Protocol servers to originate and archive alerting messages. Coordinates with broadcasters and cable providers and provides program guidance and technical assistance if required.

Performs emergency management related communications systems analysis and evaluation; engineers communications and warning systems for state and county emergency management / civil defense systems as required.

Establishes, maintains, and operates HI-EMA emergency communications and warning systems throughout the state; in the event of an activation of the SEOC, performs emergency telecommunications as required.

Plans, prepares, and directs training programs for HI-EMA communication and warning system personnel and establishes staffing patterns for routine and emergency operations.

Coordinates HI-EMA communications matters with federal, state, and county governments, and private organizations and individuals throughout the state.

Maintains and operates a HI-EMA communications-electronics maintenance program and facility.

Maintains accurate stock levels, accountability, and inventory of communications equipment, supplies, and parts; develops and maintains a computer data base listing stock levels, status of parts inventory, acquisition dates, etc.

#### INFORMATION TECHNOLOGY (IT) SECTION

Advises the Communications Branch Director and the Administrator on all information technology matters.

Plans, develops, manages, and operates the division's computer system; coordinates, integrates, implements and maintains the electronic data processing and office automations systems and procedures; and analyzes, evaluates and makes recommendations on the automation of emergency management / civil defense programs.

Also supports Departmental IT tasks and projects.

#### COMMUNICATIONS AND WARNING SECTION

Oversees, improves, and maintains HI-EMA telecommunications systems and siren warning systems. Maintains and repairs all outdoor siren warning systems throughout the state. Monitor siren status, establish repair schedule, coordinate siren repairs with the counties, and dispatch siren repair teams as needed. Conduct post-disaster system assessment, prioritize sirens for repair and replacement, and direct the field work of repair teams.

#### EMERGENCY OPERATIONS CENTER (EOC) SUPPORT SECTION

Oversees the state emergency management video teleconference (VTC) system, including the encrypted VTC equipment at Birkhimer and in the Governor's Office. Supports the State Emergency Response Team during activations of the State Emergency operations Center.

#### LOGISTICS BRANCH

Advises the Administrator on all logistical matters.

Identifies and coordinates all logistical requirements for disaster response with counties, state, and Federal agencies. Responsible for emergency support function 8 – logistics operations during disaster responses.

Oversees the agency's warehouse operation, including inventory control measures, maintenance of equipment in the warehouse, and developing issuing procedures and guidelines.

Assists with the annual inventory of all State property assigned to HI-EMA; processes and submits to the finance section inventory change documents; and processes equipment disposals as required.

Oversees maintenance of agency facilities, including janitorial requirements; develop and oversee safety and security requirements and guidelines for the facilities; manage Capital Improvement Program (CIP) projects for agency facilities.

#### SERVICE SECTION

Updates the logistics portion of emergency operations plans in coordination with state, county, and Federal agencies.

Manages all Capital Improvement Projects from formulation, through legislative funding, design and construction to final acceptance from the contractor.

#### SUPPORT SECTION

Oversees the agency's warehouse, including ordering, receiving and inventorying of stock, and issuing disaster relief supplies.

Maintains stored equipment to ensure it is ready when needed in the aftermath of a disaster.

Oversees all maintenance and janitorial activities for the agency's facilities.

#### EXTERNAL RESOURCES SECTION

Oversees the EMAC resource management system – involves resource updates from out of state (CONUS) support options and preparation of plans and exercises to secure resources from other states in the event of an emergency under EMAC.

Includes the identification and location of appropriate resources, coordination of travel and reimbursements for supporting personnel, and documentation of duties performed or resources received.

Coordinates deployment, storing, and issuance of FEMA and other out of state logistics resources during disasters.

#### FINANCE AND ADMINISTRATIVE SECTION

Advises the Administrator on all administrative actions; processes personnel actions for the agency; develops division policies as needed; maintains hard copy and electronic file systems; develops, processes, and submits position extensions and hiring requests.

Advises the Administrator on all fiscal matters; develops and oversees procedures for a requirements-based budget for the agency; works with other branches and sections to develop an annual budget for the agency; submits the agency's budget and all supporting documentation as required by the finance officer. Manages all Federal grants applicable to HI-EMA operations.

Oversees annual inventory of state equipment; process and submit inventory change documents.

STATE OF HAWAII  
DEPARTMENT OF DEFENSE  
HAWAII NATIONAL GUARD YOUTH CHALLENGE ACADEMY

The Hawaii National Guard Youth Challenge Academy (HINGYCA) is part of a nationwide strategy to help at-risk youths, ages 16-18, reclaim their lives. The Academy is a voluntary and drug-free program where military style discipline provides a strong platform for self-control, responsibility, respect and resourcefulness. The Academy's academic curriculum is based on the Department of Education Competency-Based High School Diploma (C-B) program, which is supplemented with comprehensive work and life skills training.

Successful completion of this program will lead to post-secondary school education, vocational training, full-time and part-time employment or opportunities in the United States Armed Forces.

ADVISORY COMMITTEE

Appointed by the Adjutant General (TAG) to provide advice and support for the delivery of a successful program.

Assists the Academy in grants, job opportunities for graduates, mentor referrals and other related activities that support the Academy's goals and objectives.

Provides guidance and advice to the program as representatives of the military, academic, business and government communities.

OFFICE OF THE DIRECTOR

Under the direction of the Adjutant General, provides direction and general supervision of all functions and activities for the Hawaii National Guard Youth Challenge Programs (HINGYCP).

Plans, organizes, directs and coordinates the operations of the HINGYCP in accordance with the State and Federal Master Youth Program Cooperative Agreement.

Develops and implements the Academy's program policies and procedures.

Develops the annual budget for legislative funding; applies for, receives and disburses all funds.

Supervises the performance of subordinates in the planning, coordination, and evaluation of HINGYCA staff and program participants.

Confers with the Youth Challenge Programs Advisory Committee on HINGYCP developments, improvements and policy initiatives.

Serves as the Point of Contact for the National Guard Bureau (NGB), the United States Property and Fiscal Office (USPFO) and the Department of Education (DOE).

Employs and retains such staff as may be necessary to fulfill the HINGYCP responsibilities.

Contracts for services or enters into agreements with other Federal, State or County agencies to successfully carry out the mission of the HINGYCP.

Provides assistance, support and coordination services for the Youth Challenge Parent Support Group, a voluntary group of parents and former Academy members.

Office Services Section

Provides secretarial, clerical and other office support services to the Office of the Director and other organizational segments of HINGYCA as needed.

RESOURCE MANAGEMENT BRANCH

Plans, coordinates and supervises administrative support services to the HINGYCA in five areas: Health Services, Administrative/Logistic, Management Information System, Budget and Community Program



Sections. Conducts periodic inspections to ensure the safety and health of participants. Supervises the performance of subordinates and contractors providing logistical support. Plans and coordinates the hiring of appropriate personnel.

#### Health Service Section

Provides medical testing, evaluation, monitoring, sick calls and medication to Cadets enrolled in the HINGYCA as required and appropriate. Provides 24/7 minimum health care services.

#### Administrative/Logistic Section

Plans and executes an expenditure plan for the purchase of goods and services required for the HINGYCA.

Provides purchasing, forecasting, accounting, financial analysis and reporting services for HINGYCA.

Coordinates fiscal, supply, food services, maintenance and safety activities.

Organizes and directly oversees material and supply acquisitions; coordinates transportation requirements; tracks Academy inventory.

Provides maintenance and repair services of the grounds and facilities used by the Academy.

#### Management Information System (MIS) Section

Receives and compiles data from all staff sections and submits required reports to the National Guard Bureau.

Sustains and maintains computer software and hardware, Local Area Network (LAN) system; trouble shoots all computer related problems for the HINGYCA.

Conducts in-house computer training for HINGYCA staff.

#### Budget Section

Provides all budget related services for the HINGYCP including development, justification, reports and execution of the federal and state authorized budget.

Assists with organization chart and functional statement updates.

Provides purchasing, vendor payments and reconciliation reports for separation of duties oversight for the Administrative/Logistic group. Audits purchase orders and pCard transactions for accuracy and compliance.

#### Community Program Section

Conducts substance abuse prevention classes. Provides guidance on seeking support, communication, discipline, goal setting and stress management related to healthy lifestyles and choices.

Promotes physical and emotional well-being among the students. Encourages strengthening of family, support and community bonds.

#### OPERATIONS BRANCH

Plans, coordinates and supervises program operations of the HINGYCA in five areas: Placement/Mentor, Academic, Counseling, Residential Training, and Program/Recruiting Sections.

The Branch provides appropriate personnel to recruit, teach, counsel and prepare HINGYCA youth to achieve success.

#### Placement/Mentor Section

Responsible for the recruitment, screening, training and placement/matching of voluntary mentors assigned to each Academy graduate.

Responsible for the planning, training, coordination and implementation of the Post Residential Action Plan.

Provides a mentor to each graduate for 12 months after graduation to provide continued assistance and support to the graduate, as mandated by the NGB.

Provides post-graduate monitoring of Mentor-Mentee matches, conducts mentor training, documents Mentor follow-up, manages corps members' stipend funds and tracks Academy graduate outcomes.

#### Academic Section

Coordinates the work of instructors, plans for staff development activities, monitors and provides guidance on Competency-Based High School Diploma curriculum as stipulated by DOE provisions.

Develops the curriculum budget and expenditure plans, orders curriculum supplies and equipment, assists with lesson planning and classroom instruction.

Provides the academic activities following the specified curriculum by implementing appropriate learning experiences to meet the needs of the students.

#### Counseling Section

Coordinates counseling services, staff development activities, workshops/in-service training, parent meetings, and counseling's budget and expenditure plan.

Provides counseling services to support the residential and post-residential objectives of the Academy, including the tracking of graduates. Interacts with mentors to follow the progress of graduates in meeting their life goals.

Coordinates activities including individualized and group counseling, parental counseling, anger management classes, individual life plan provisions, placement in higher education, vocational/technical training and enlistment into military services.

#### Residential Training Section

Oversees the Academy's military section with direct supervision of Cadre Shift Leaders, Assistant Shift Leaders and Cadres, who supervise the students.

Coordinates work assignments, provides on-the-job training, and evaluates job performances.

Develops the training calendar for non-academic activities, develops Standard Operating Procedures, plans and coordinates community service projects with outside agencies.

Instills discipline in each student and provides direct supervision 24/7 for 22 weeks during the residential phase.

Provides purpose, direction, motivation, and supports the health and safety of each student to meet the objectives and mission of the HINGYCA.

#### Program/Recruiting Section

Provides recruitment of high school student applicants and follow up services.

Conducts testing, one-on-one interviews with prospective students, parents or guardians, and determines eligibility for admission into the HINGYCA.

Serves as the Point of Contact for the DOE high school principals, vice-principals, counselors and Family Court staff.

STATE OF HAWAII  
DEPARTMENT OF DEFENSE  
OFFICE OF VETERANS SERVICES

The Office of Veterans Services (OVS), administratively assigned to the State Department of Defense, is the principal agency in State government responsible for the administration, conduct, and coordination of all functions and activities prescribed under Chapter 363, Veterans Rights and Benefits', Hawaii Revised Statutes, as amended.

This OVS also provides functional oversight to the eight State Veterans Cemeteries (Kaneohe, Kauai, Maui, Lanai, Molokai, East HI 1 and East HI 2 in Hilo, and West HI in Kona) located on six major islands.

Office of the Director

Provides direction and general supervision of all functions and activities statutorily and administratively assigned to the Office of Veterans Services, confers with the Advisory Board on Veterans' Services, and advises the Governor on new legislation, programs and policy initiatives.

Serves as the principal official in State government responsible for the development, performance, and control of programs, policies and activities on behalf of veterans and their dependents.

Directs, controls and supervises the performance of subordinates in such areas as planning, evaluation and coordination of veterans' programs and development of a statewide veterans services delivery network.

Assesses the policies and practices of other agencies concerning the delivery of services and benefits provided to veterans and their dependents.

Administers funds allocated for the office, and applies for, receives, and disburses grants and donations from all sources for veterans programs.

Establishes and maintains a clearinghouse for complaints of persons regarding services to veterans, or operations of State and county agencies affecting veterans; investigates such complaints and refers the complaints and investigation findings to the appropriate agencies for corrective action.

Develops, adopts, amends, and repeals rules pursuant to Chapter 91, Hawaii Revised Statutes.

Employs and retains such staff as may be necessary for purposes of carrying out program responsibilities.

Contracts for or grants such services, including entering into master contracts with other State agencies receiving Federal and State funds for veterans.

Provides for the special housing needs of disabled veterans as defined under Section 363-11, Hawaii Revised Statutes.

Plans, develops, establishes and operates the Hawaii State Veterans Cemetery (HSVC) on Oahu in accordance with the U. S. Department of Veterans Affairs and State guidelines; oversees the maintenance of eight State veterans cemeteries as defined and operated under Sections 363-4, 5, and 7, Hawaii Revised Statutes.

Advisory Board on Veterans Services

Advises the Director in areas relating to the identification of issues and solutions; development of position papers; advocacy and legislative actions; program development and operations; and other matters as may be deemed important to the betterment and well-being of veterans.

Members are representative from a cross section throughout the State with the following breakout: 1-Kauai, 1-Maui, 4-Oahu, 2-Hawaii, with the ninth member being the Director of the State Office of Veterans Services who participates as an ex-officio voting member. By the Board Charter, three of the Board members must be female. The Board meets monthly utilizing video-conferencing with one fact to face session a year with all members.

#### Administrative Services Section

Establishes and maintains accounting systems and procedures to control and support all fiscal activities of the State agency and grantees in accordance with State and Federal policies, rules, and laws.

Prepares and submits reports in a timely manner in such form, and containing such information as may be required.

Establishes and maintains policies and procedures to control and support property management activities of State agencies and grantees in accordance with State policies, rules and laws.

Maintains applicable policies and procedures to control and support all personnel management activities in accordance with State policies, rules and laws.

Plans, develops, and monitors State agency operating policies, procedures, budget and program memoranda, and directives.

Establishes and ensures effective office operations for the OVS on Oahu, Maui, Kauai and Hawaii islands.

Manages and coordinates OVS automation, data processing, information management and related activities.

#### Office Services Section

Provides secretarial support services for the Director and staff to enhance achievement of program objectives and responsibilities in a timely manner.

Provides logistical support for board meetings, committee meetings, and interagency meetings, by arranging for meeting place, by calling members to assure a quorum, and providing supplies as appropriate.

Provides Board support by: creating and disseminating notice of meetings; by taking, transcribing, typing, printing, and disseminating minutes of meetings; by maintaining records of meetings and up-to-date list of names and addresses of individuals who request notification of meetings, and by typing and mailing correspondence.

Establishes and maintains public record files and confidential files, and retires files for long retention and future disposal, or for permanent record with State Archives.

Receives a variety of inquiries and request for information in person, by mail or telephone, and gives information on public records or provides individual access to public records for inspection purpose, and provides copies as may be requested.

Maintains executive and external agency memoranda, instructions, procedures, circulars and directives on an ongoing basis for easy access and use.

Provides assistance in securing legal change of name.

Maintains resource library which includes among other materials, books, publications, reports, statutes, session laws, films, microfiche, and provides access and assistance to users.

Veterans Services Branch

The Veterans Services Branch is a statewide operation that plans, directs, evaluates and provides information, referral, advocacy, counseling, and other appropriate services to veterans, their dependents and survivors.

Advises the Director on all matters pertaining to veterans' services provided by government agencies and private nonprofit organizations, including other veterans' affairs agencies that relate to or impact upon veterans, their dependents and survivors.

Cooperates with agencies in the community to coordinate and maximize the effectiveness of all services and benefits that are available to veterans, their dependents and survivors.

Provides direct and strict oversight to the burial protocol for deceased indigent veterans who do not have surviving family members or next of kin to support internment requirements.

Participates in Veterans Homeless Stand Downs, Veteran Resource Workshops, and special ceremonies honoring veterans and their families.

Veterans Services Sections (Hawaii, Kauai, Maui and Oahu)

Manages the delivery of State veterans' services within each County. Acts as a point of contact within the County for all issues relating to veterans.

Maintains an office to which veterans and their families come for information, counsel, assistance, and referrals to other appropriate agencies in the County, State or Federal jurisdictions.

Assist in the planning, evaluation, and coordination of veterans programs.

Coordinates with veterans and community groups on matters and concerns relevant to veterans, their dependents, and survivors.

Advocates for veterans and dependents in attaining rights and benefits to which they are entitled.

Assembles, analyzes, compiles, and disseminates current information concerning rights, benefits and services to which veterans and their dependents and survivors are entitled, including structural and functional descriptions of organizations providing veterans assistance services.

Maintains contact and service links in the statewide veterans' service delivery network.

Provides technical assistance to veterans' memorials and organizations and participates in community Veterans Day and Memorial Day planning committees and other committees addressing the promotion and betterment of veterans.

Provides assistance in helping eligible veterans to prepare an affidavit of support to sponsor dependent family members who are considered aliens to enter the United States.

Provides recordation and forms preparation assistance services.

Provides Public Notary services to the veteran community tied to disability claim submittals.

Hawaii State Veterans Cemetery Branch

The Hawaii State Veterans Cemetery Branch implements the programs of the Office of Veterans Services relating to veterans' burial needs, and establishes, directs, and maintains all activities of the cemetery.

STATE OF HAWAII  
DEPARTMENT OF DEFENSE  
FUNCTIONAL STATEMENTS

Advises the Director on all matters relating to policies, administration and operation of the HSVC; provides guidance and technical assistance to neighbor island cemetery managers when requested.

Coordinates burial-related activities; establishes eligibility, schedules internments, assigns gravesites, orders markers, installs temporary and permanent markers, coordinates with private mortuary representatives, maintains records of all internments and other related activities.

Works with local mortuary and/or funeral directors, Army Mortuary officials and clergy to coordinate funeral services and military honor details. Represents the State and ensures that committal services are conducted with dignity, and that the bereaved are treated with compassion.

Establishes and maintains a comprehensive public affairs program; provides veterans with information about burial eligibility, procedures, regulations, etc.; coordinates ceremonial functions with the Office of the Governor, Office of the Mayor, veterans' organizations, local military, and other special interest groups.

Prepares the cemetery grounds and ceremonial mall twice a year for the Governor's memorial Day and Veterans Day events attended by senior officials from the State, Federal and County governments, our Congressional delegation, military officials, the Consulate General Corps, members of the community, and most importantly, our veterans and their loved ones. These ceremonies average between 800-1,000 people attending.

Handles all procurement services for the needs of HSVC by processing the necessary documents such as purchase orders, p-cards, request for contracts, etc.