

Supplemental Budget Request FY2014-15

Presentation to the House Finance and Senate Ways and Means Committees
JANUARY 14, 2014

HAWAII STATE DEPARTMENT OF EDUCATION
HawaiiPublicSchools.org

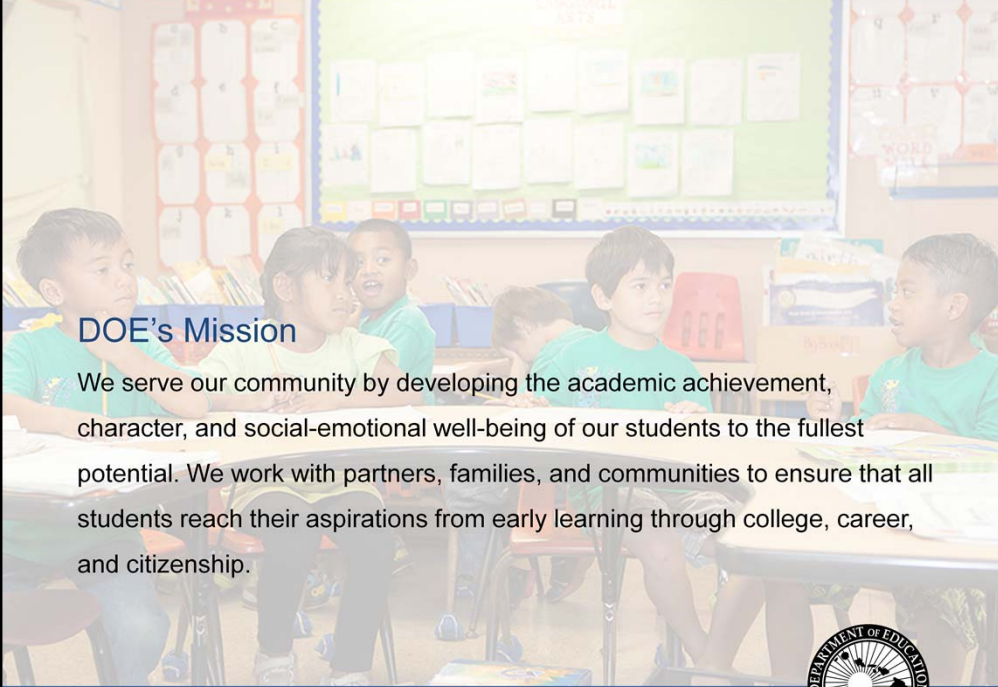



DOE's Mission

We serve our community by developing the academic achievement, character, and social-emotional well-being of our students to the fullest potential. We work with partners, families, and communities to ensure that all students reach their aspirations from early learning through college, career, and citizenship.

HAWAII STATE DEPARTMENT OF EDUCATION
HawaiiPublicSchools.org



2

Meeting high expectations requires having a high level of customized and responsive support, and we are building the resources needed to promote excellence and lifelong learning for students and adults alike. We are working together to strengthen our tools and capacity around using data on student and school success to guide improvement.

At all levels of the DOE, we are working to improve and build a culture that reflects our Core Values — Commitment to Equity and Excellence; Meaningful Learning; Caring Relationships; and Connection to Community, Family, and 'Aina.

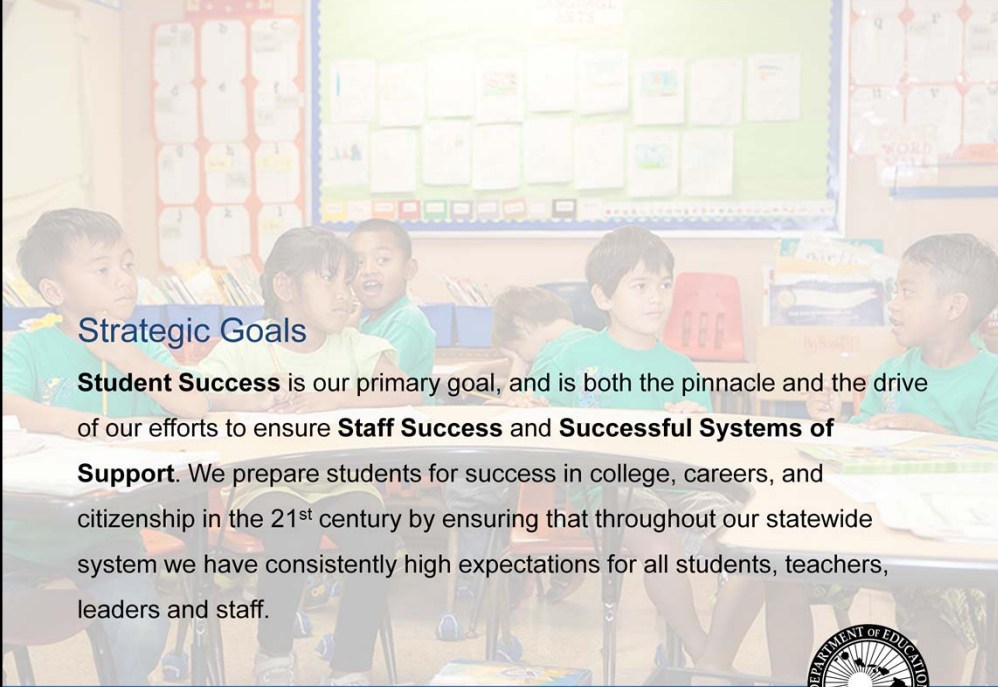

Strategic Goals

Student Success is our primary goal, and is both the pinnacle and the drive of our efforts to ensure **Staff Success** and **Successful Systems of Support**. We prepare students for success in college, careers, and citizenship in the 21st century by ensuring that throughout our statewide system we have consistently high expectations for all students, teachers, leaders and staff.

HAWAII STATE DEPARTMENT OF EDUCATION
HawaiiPublicSchools.org



3

Student achievement is at the core of the Department and Board of Education's Strategic Plan, which sets clear and measurable objectives through 2018.



Goals are backed by measurable objectives and strategies to ensure the joint DOE/BOE mission is moving forward.

The Department's goals are reflected here and depicted by color.

Goal 1 (orange) – Student Success

Goal 2 (green) – Staff Success

Goal 3 (blue) – Successful Systems of Support

In order to achieve these goals, the Department has created 6 Priority Strategies to create a framework of supports, actions and deliverables. You can learn more about that on our website. (Search for “Strategic Plan” or “6 Priority Strategies”) Direct URL: <http://bit.ly/DOEBOEstratplan>

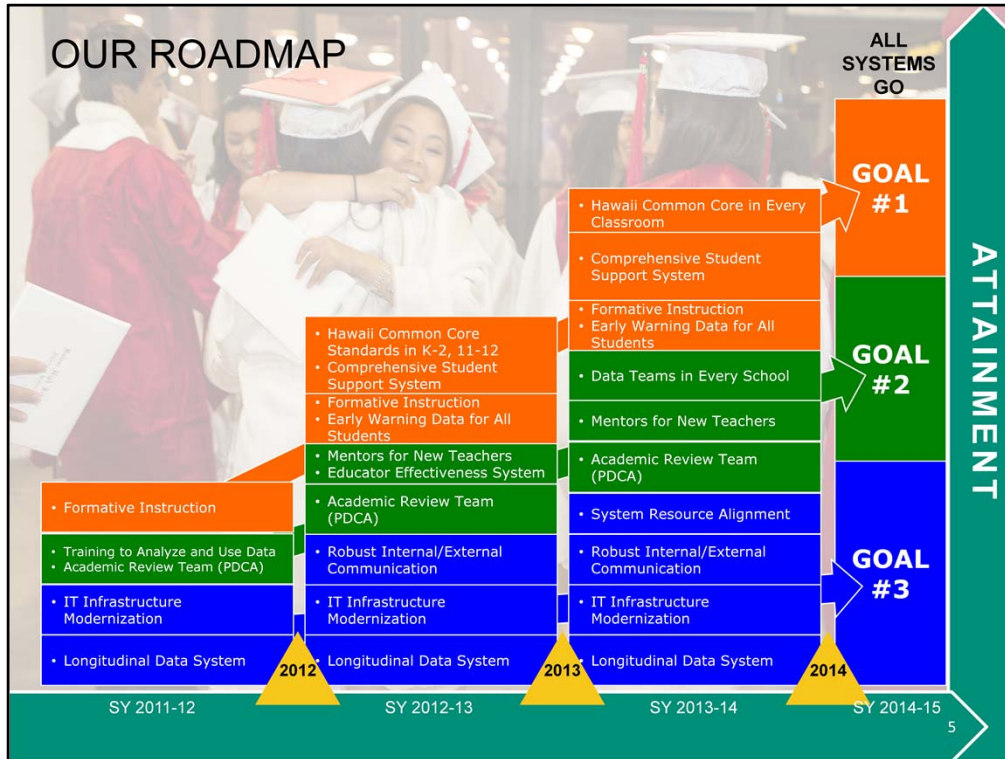

PDCA – Plan-Do-Check-Act

Within the DOE’s three overarching goals, our specific strategies and targets during the next six years focus our efforts on:

- Promoting academic excellence:** The Department is implementing a K-12 curriculum with clear standards, and are developing multiple measures of success so that rather than “teach-to-the-test” we offer a well-balanced curriculum that gives students a breadth of knowledge and experience.
- Promoting and rewarding excellent teaching:** The Department helps our existing teachers be effective through tailored professional development and support. Improving our recruiting, induction, and mentoring efforts so that we can continue to attract, prepare, and retain the best teachers.
- Providing better data, information, and tools at the classroom, school, and Complex Area levels:** The Department helps teachers and principals understand, assess, and communicate about student engagement and academic progress throughout the year. This includes new tools such as the ACT and real time data on student success to help educators tailor instruction to meet the needs of all of their students.
- Promoting healthy and positive school climates that support student success:** The Department has a data system that allows educators to track student safety and ensure schools consistently establish and implement the policies and programs that lead to positive learning environments and good citizenship.
- Improving our communication internally and externally so that we can all work together in support of Student Success:** The Department is reaching out to our families, communities, and businesses; building stronger partnerships to support student learning; and promoting learning opportunities beyond the classroom. This includes new tools such as the ACT and real time data on student success to help educators tailor instruction and support to meet the needs of all of their students.

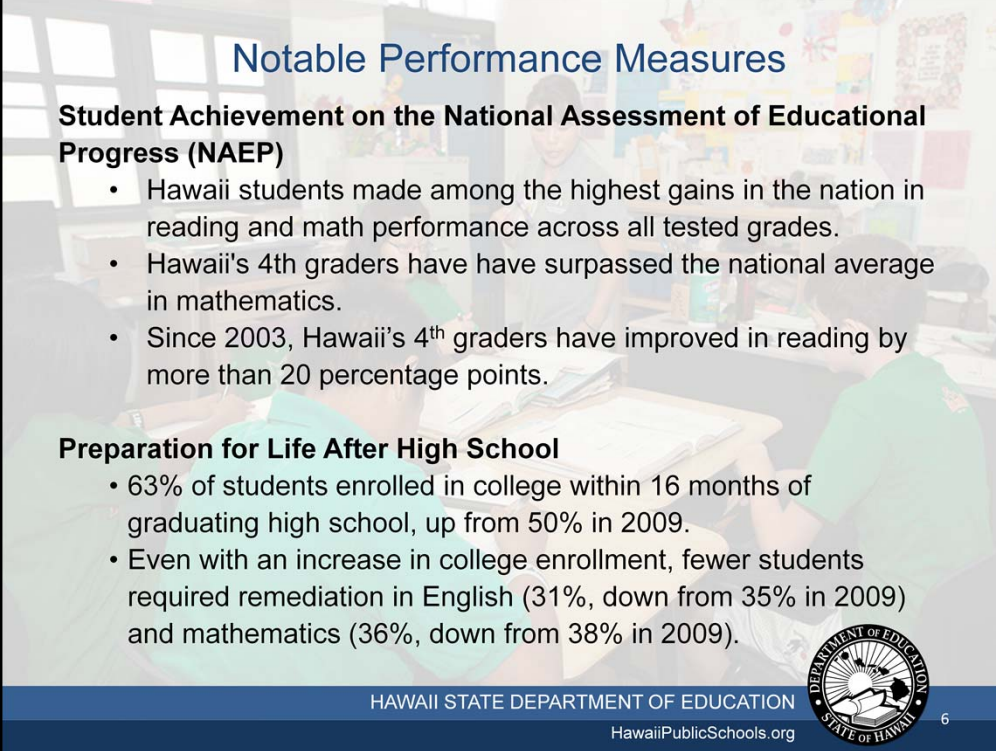

Notable Performance Measures

Student Achievement on the National Assessment of Educational Progress (NAEP)

- Hawaii students made among the highest gains in the nation in reading and math performance across all tested grades.
- Hawaii's 4th graders have surpassed the national average in mathematics.
- Since 2003, Hawaii's 4th graders have improved in reading by more than 20 percentage points.

Preparation for Life After High School

- 63% of students enrolled in college within 16 months of graduating high school, up from 50% in 2009.
- Even with an increase in college enrollment, fewer students required remediation in English (31%, down from 35% in 2009) and mathematics (36%, down from 38% in 2009).

HAWAII STATE DEPARTMENT OF EDUCATION
HawaiiPublicSchools.org



6

In 2013, our students and educators brought acclaim to their communities and their families. The NAEP results showed that Hawaii's fourth-graders outperformed their national peers in mathematics, and that they, along with our eighth-graders, continue to progress in both mathematics and reading:

- 4th grade math: largest gains in the nation
- 8th grade math: 3rd largest gains in the nation
- 4th grade reading: 4th largest gains in the nation
- 8th grade reading: 10th largest gains in the nation

"Hawaii maybe hasn't always been thought of as a leader in education, quite frankly, but this year's NAEP results show that Hawaii's students made very, very encouraging progress. They continue to improve in nearly every area. I think Hawaii, to their tremendous credit, has proved a lot of skeptics wrong." -- United States Secretary of Education Arne Duncan

We are experiencing this success despite financial challenges and increasing demand for public school services.

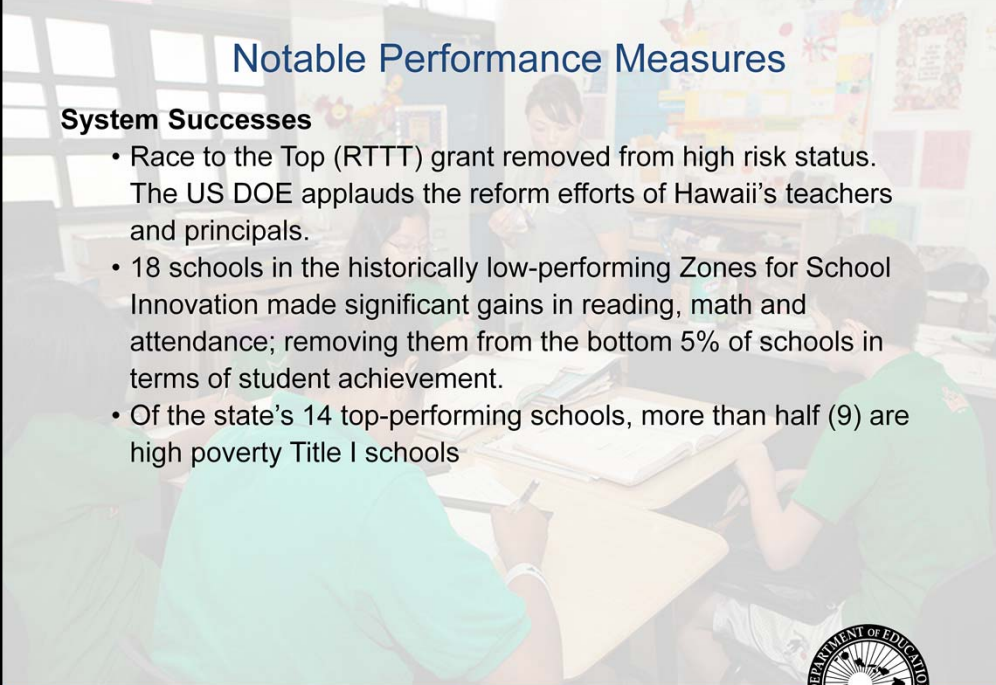

Notable Performance Measures

System Successes

- Race to the Top (RTTT) grant removed from high risk status. The US DOE applauds the reform efforts of Hawaii's teachers and principals.
- 18 schools in the historically low-performing Zones for School Innovation made significant gains in reading, math and attendance; removing them from the bottom 5% of schools in terms of student achievement.
- Of the state's 14 top-performing schools, more than half (9) are high poverty Title I schools

HAWAII STATE DEPARTMENT OF EDUCATION
HawaiiPublicSchools.org



7

"Hawaii is a good example for the country" in setting high standards, said Chris Minnich, executive director of the Washington, D.C.-based Council of Chief State School Officers.

"The NAEP scores alone are reason enough to pay attention to what Hawaii is doing. Hawaii's education leaders deserve a lot of credit for pushing ahead with coherent, bold reform agenda." – Michael Petrilli, the Thomas B. Fordham Institute

Notable Performance Measures

System Successes

Achieve's 8th annual "Closing the Expectations Gap" report praised Hawaii in several categories detailing progress in elevating student achievement and success. Hawaii is:

- One of 10 states that have adopted college and career readiness standards and assessments capable of producing a score that colleges value
- Taking steps to ensure that teacher preparation programs and licensure requirements are aligned to state standards
- One of 11 states to require the ACT test for all high school students
 - ✓ With the new Strive HI Performance System, DOE financial support allows more students to take the ACT

HAWAII STATE DEPARTMENT OF EDUCATION
HawaiiPublicSchools.org



8

Hawaii was highlighted in Achieve – a national educational organization that works with governors and business leaders to support college and career readiness. The recent Achieve report praised Hawaii's achievements in preparing students for success after high school.

The ACT is a curriculum-based examination that can provide helpful information for all students, not just those who are planning to attend college. Taking the ACT can give every student a measure of his or her academic strengths and weaknesses. Students may use their results to recognize their academic strengths and areas where they need to improve, whether they intend to go to college or enter the workplace after high school.

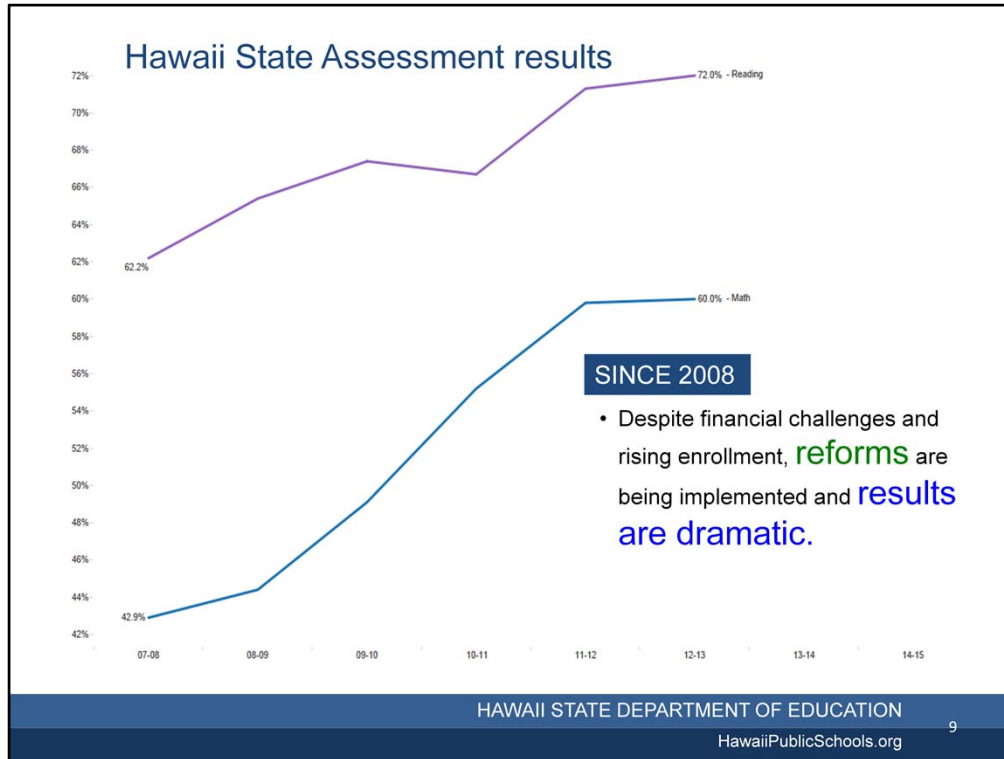

These show student achievement in reading and math on the Hawaii State Assessment from 2008 until 2013.

- 72% of students were proficient on the Hawaii State Assessment in Math in 2013, up from 67% in 2010.
- 60% of students were proficient on the Hawaii State Assessment in Reading in 2013, up from 49% in 2010.

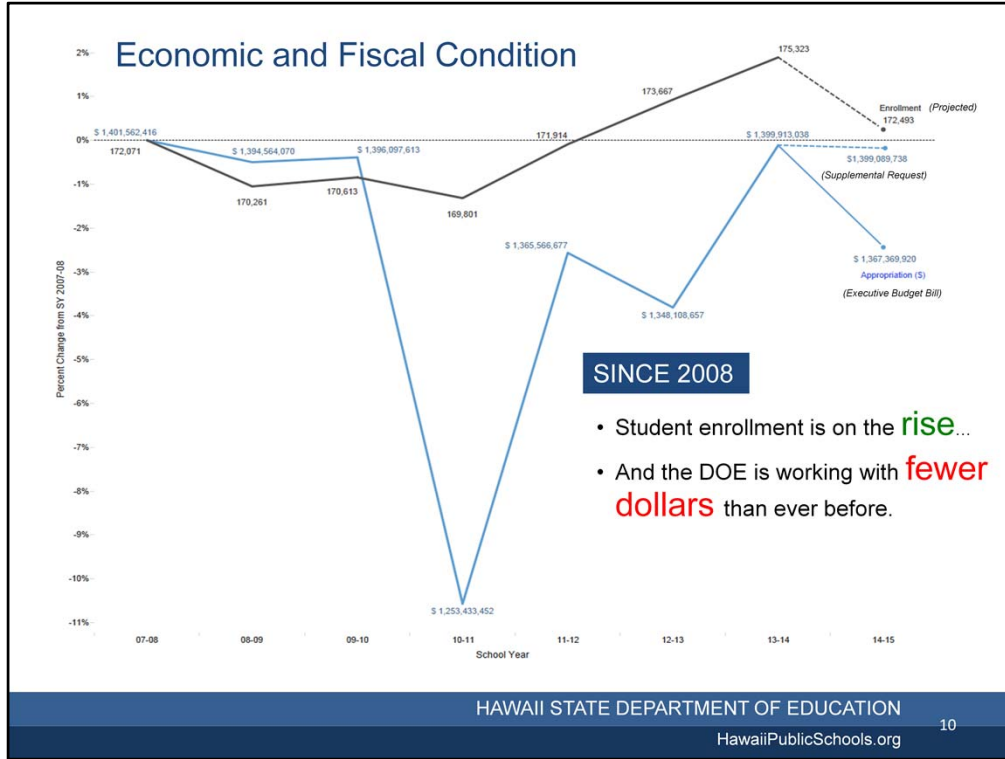

State funding has been relatively flat since 2008. To support student achievement, state-level expenditures focus on adding support for schools through targeted and aligned resources.

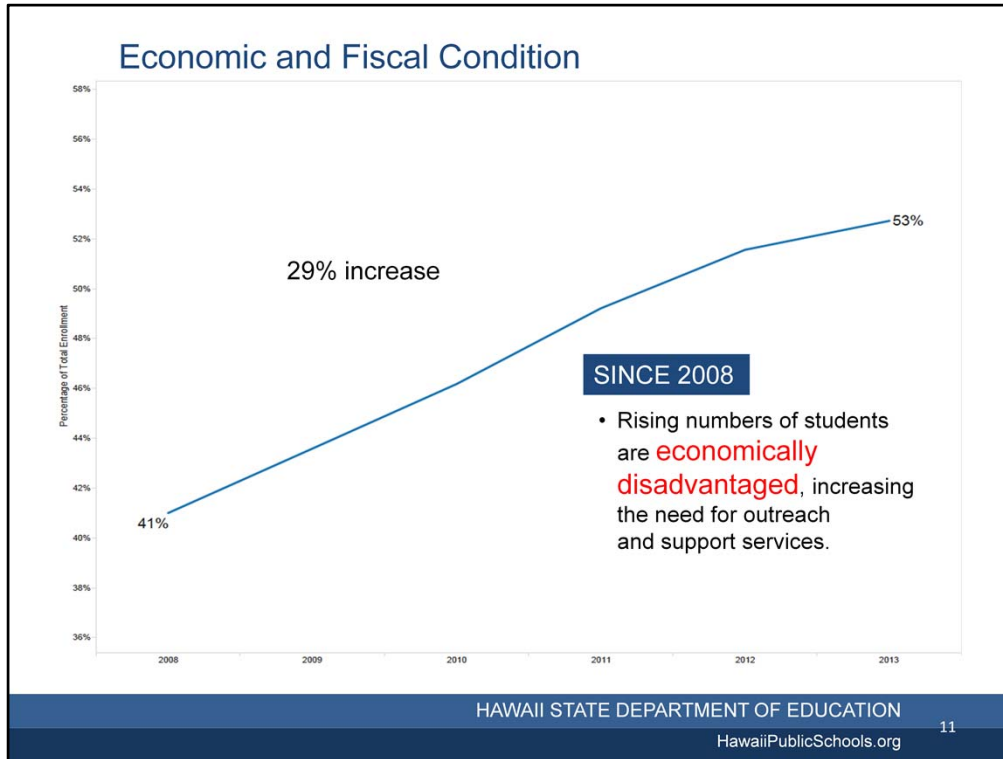

The Department is efficiently using its existing resources. However, with the rising numbers of economically disadvantaged students there are challenges and stressors on the system to provide adequate level of student support.

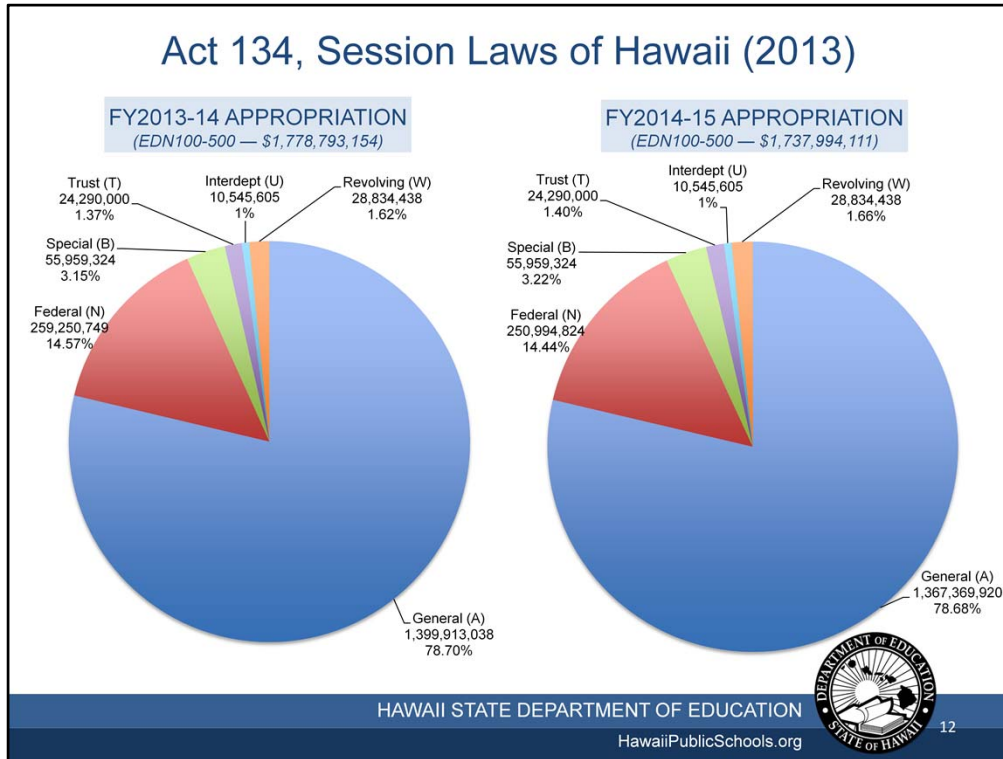

Federal funds are 14% of our total budget. The major pieces of this are Title I, Title II, IDEA, and Impact Aid. (Details outlined in Table 11 of budget package provided to WAM and FIN).

Federal sequestration had minimal impacts due to strategic use of excess Impact Aid and strict review and management of federal funds — while aligning ALL funding to Strategic Plan goals.

September 2014 marks the conclusion of the 4-year, \$75 million Race to the Top (RTTT) grant. The Department is ensuring sustainability of ALL the work for which the RTTT Grant provided seed funding. Indeed, much of that work is represented in our Strategic Plan and Strive HI Performance System. Approximately \$5.6m of our supplemental budget request relates to sustainability efforts that are not able to be funded by other means but are essential to sustain. For details on the RTTT sustainability plan, see reference sheets at the end of this presentation.

The longer it takes to settle the federal budget, the harder it will be to determine how to best leverage federal funds for SY15. IDEA and Title I are critical supplemental funds for high needs students – and funding levels are necessary to serve these students.



Operating Budget

HAWAII STATE DEPARTMENT OF EDUCATION
HawaiiPublicSchools.org



13

DOE's State Budget Program IDs		
EDN 100	School Based Budgeting	To assure all student receive instruction consistent with the standards so they may achieve those standards and develop to their fullest potentials in alignment with the General Learner Outcomes.
EDN 150	Special Education and Student Support Services	To ensure that student learning takes place within an educational, social, and emotional context that supports each student's success in achieving the standards.
EDN 200	Instructional Support	To support the instructional program by providing assistance to schools and complexes in implementing standards; developing, training, monitoring new and existing curricula and instructional strategies that support student attainment of the standards; testing; and reporting on student, school and system accountability in a responsive and expedient manner.
EDN 300	State Administration	To facilitate the operations of the public school system by providing leadership, management, planning, fiscal, logistical, technological, personnel, and other supporting services.
EDN 400	School Support	To facilitate the operations of the Department by providing school food services, services and supplies related to construction, operation, and maintenance of grounds and facilities, and student transportation services.
EDN 500	School Community Services	To provide lifelong learning opportunities for adults and to meet other community needs of the general public.



History of General Fund Appropriations

Prog ID	FY08	FY09	FY10*	FY11**	FY12	FY13	FY14***	FY15
EDN 100	774,244,048	772,086,697	753,950,947	705,214,266	778,080,508	772,510,601	817,507,508	794,398,920
EDN 150	361,156,533	355,373,685	368,188,673	306,635,452	321,550,609	313,456,272	321,843,969	321,843,969
EDN 200	34,454,113	33,297,750	29,037,169	21,956,188	45,035,424	43,767,584	45,120,095	44,132,348
EDN 300	50,381,509	55,557,715	51,432,190	42,924,189	42,831,552	41,945,114	42,276,161	42,276,161
EDN 400	170,290,488	169,455,447	184,814,106	171,841,402	173,036,458	173,929,086	170,665,305	162,218,522
EDN 500	11,035,725	8,792,776	8,674,528	4,861,955	5,032,126	2,500,000	2,500,000	2,500,000
ALL DOE EDNs	1,401,562,416	1,394,564,070	1,396,097,613	1,253,433,452	1,365,566,677	1,348,108,657	1,399,913,038	1,367,369,920

* The Department's FY10 appropriation was restricted by the former Administration by \$127.7 million.
 ** FY10 & FY11 decrease was partially offset with federal ARRA funds and some of the general funds cut in anticipation of increased federal support were restored in FY12.
 *** FY14 saw \$37.7 million in labor savings restored with employee pay being returned to the levels from FY09.

Source: Annual Executive Budget Bill Passed by State Legislature

HAWAII STATE DEPARTMENT OF EDUCATION
HawaiiPublicSchools.org



15

The year to year change in the appropriation from FY14 to FY15 is -2.32%.

If the Supplemental Request is funded in full this would translate into a 0.06% decrease in General Funds.

(The FY15 appropriation to FY15 supplemental change is an increase of 2.32%).

Since FY08, or the year preceding the economic downturn, general fund appropriations have been fairly flat, including for FY2013-14 and FY2014-15. This despite:

- The restoration of the 5% (\$37.7 million) labor savings cut that was imposed on the Department from FY10 to FY13.
- Inflation — If the general fund appropriation had kept up with the Consumer Price Index, it would have resulted in a 16.36% (\$229 million) increase since the FY08 \$1.401 billion appropriation.

Supplemental Request Summary: Operating

EDN	(1) FY 13-14 (Act 134, SLH 2013)	(2) FY 14-15 (Act 134, SLH 2013)	(3) FY 14-15 DOE Supplemental Budget Request	(4) FY 14-15 DOE Supplemental Budget Total	(4-1) / (1) % Change FY13-14 (Act 134) to FY14-15 Supplemental Budget Total
EDN100	817,507,508	794,398,920	14,999,924	809,398,844	-0.99%
EDN150	321,843,969	321,843,969	-	321,843,969	0.00%
EDN200	45,120,095	44,132,348	4,926,786	49,059,134	8.73%
EDN300	42,276,161	42,276,161	2,793,108	45,069,269	6.61%
EDN400	170,665,305	162,218,522	9,000,000	171,218,522	0.32%
EDN500	2,500,000	2,500,000	-	2,500,000	0.00%
Total	1,399,913,038	1,367,369,920	31,719,818	1,399,089,738	-0.06%

HAWAII STATE DEPARTMENT OF EDUCATION

HawaiiPublicSchools.org



16

The Department appreciates the feedback to improve our communication and transparency surrounding our budget. The feedback from the Legislature and our partners has been valuable.

The Department made significant changes to the budget development process. Beginning with our key goals as outlined in the Strategic Plan, the Department reviewed and leveraged all available internal funding sources before considering inclusion in the supplemental budget request.

The Department identified the most critical components for funding to provide direct support to schools and complex areas for successful implementation of the strategic initiatives. This includes repeat requests from the most recent biennium budget, which were not appropriated by Act 134 (SLH 2013).

Supplemental Requests by Program IDs & Goals

GOAL 1 STUDENT SUCCESS	GOAL 2 STAFF SUCCESS	GOAL 3 SUCCESSFUL SYSTEMS OF SUPPORT
---------------------------	-------------------------	---

EDN 100 – School Based Budgeting

1. **\$14,000,000 for Weighted Student Formula**
Additional \$55,555 for each of the 252 schools that receive WSF funds.
2. **\$554,379 for Advanced Placement Incentives**
Provide teacher and student supports to access and succeed in AP courses.
3. **\$120,545 for the High Core Alternative Learning Center**
Support Staff, operational and material needs of the successful High Core Alternative Learning Center, serving at-risk and alienated students.
4. **\$265,000 for WASC Accreditation: School-Level Expenses**
Facilitate ongoing school improvement efforts to achieve and maintain Western Association of Schools and Colleges (WASC) accreditation for all DOE schools (EDN 200 also has a WASC related request).
5. **\$60,000 for Strive HI Performance System: Reporting**
To build internal capacity to meet the increased data collection, analysis and reporting needs of the Strive HI Performance System (EDN 200 also has a Strive HI related request).



HAWAII STATE DEPARTMENT OF EDUCATION
HawaiiPublicSchools.org

NUMBER 1: WSF, \$14m

- The increase in base funding at each school will help to address: funding adequacy at all schools and the additional demands being placed on school staff around implementation of educator effectiveness, student data assessment, induction and mentoring, Elementary and Secondary Education Act (ESEA) Flex, information technology support, and Hawaii Common Core standards.
- Schools have indicated that WSF is transparent, predictable and equitable but NOT adequate, as outlined in a study done by 3rd party to help inform the Committee on Weights. This request will provide the approximate “value” of a teacher position while maintaining a principal’s autonomy to add resources where they will positively impact student achievement the most. These resources could be added to bolster resources in the 6 Priority Strategies.

NUMBER 2: AP, \$554,379 (includes funding for operating expenses and salary for an appropriated position)

- The funds will provide for one state level resource teacher to help administer student support programs. This position serves as a liaison between State offices and schools. The requested operating funds will provide services to increase student achievement in AP courses through AP Saturday prep sessions, Brain Camp, AP mock exams, training for administrators and counselors, and other professional development activities.
- Student participation in AP courses has increased 48% over the last five years.
- In 2012, the passing rate on the AP exam increased by 9% over the previous

year.

- Through the AP Incentive Program, the DOE has steadily increased the number of students taking an AP exam from 4,935 in 2009-2010 to 6,669 in 2012-2013.
- Federal funds supporting this program expire June 30, 2014.

NUMBER 3: High Core, \$120,545 (including funding for appropriated positions)

- Pursuant to Section 18 of Act 134, Session Laws of Hawaii 2013, \$535,423 shall be expended in both FY 2013-14 and FY 2014-15 for the operation of the High Core (Storefront) Alternative Learning Center. As the program has set aside only \$414,878 in each year for operation of High Core, an additional \$120,545 is needed in FY 2014-15 to meet the requirements of the budget proviso in Act 134. The additional funds will provide for eight Part Time Teachers (PTTs) and a counselor for the extended day and night school component of their services (\$81,200); operating expenses to continue to exist in the off campus location (\$19,000); educational supplies and materials including workbooks, textbooks, and janitorial supplies (\$20,345).
- Of the 232 students serviced by High Core in School Year 2012-13, 91% completed their remaining diploma requirements.
- 62% of all students were able to return to a regular school setting, and of those, 95% passed their courses at their new school.
- Since opening its doors in 2000 to at-risk youth in Central Oahu, High Core has helped more than 3,650 students. Of those, 3,597 graduated.

NUMBER 4: WASC Accreditation, \$265,000

- These funds will facilitate school improvement efforts through the accreditation process and the implementation of the State Strategic Plan, Academic and Financial Plans, and to prepare schools for the on-site accreditation visit by providing appropriate technical assistance and training activities for school leaders and school staff. In addition, the Department will alleviate the school level cost burden of WASC accreditation by centralizing the purchase of the WASC subscription. This also allows for the state to realize savings by creating economies of scale.
- The requested operating funds will facilitate school improvement efforts through the accreditation process and the implementation of the State Strategic Plan, Academic and Financial Plans, and to prepare schools for the on-site accreditation visit by providing appropriate technical assistance and training activities for school leaders and school staff.
- As of December 2013, 37% of all DOE schools, including all DOE middle and high schools, have received WASC accreditation. The Department plans to accredit an additional 30 schools/year, to meet the goal of accrediting all DOE schools by 2018.
- An initial review of the first 32 elementary schools to participate in the accreditation process this school year was met with positive feedback from WASC.

NUMBER 5: Strive HI, \$60,000

- These funds will expand existing services to support: 1) data validation work required by an independent vendor for student achievement; and 2) yearly processing and modifying ESEA accountability analyses and reports.
- The new Strive HI Performance System takes into account multiple measures of a school's performance, as opposed to just the test results from that year. This means an increase in the quantity and complexity of data collection and analysis.

Supplemental Requests by Program IDs & Goals

GOAL 1 STUDENT SUCCESS	GOAL 2 STAFF SUCCESS	GOAL 3 SUCCESSFUL SYSTEMS OF SUPPORT
---------------------------	-------------------------	---

EDN 200 – Instructional Support

- 1. \$2,000,000 for Strive HI Performance System**
Support for focus and priority schools, including public charter schools.
- 2. \$600,000 for Hawaii Common Core Digital Curriculum pilot**
Ongoing professional development and technology support needs for the 8 participating schools.
- 3. \$250,000 for Formative Instruction**
Provide professional development to schools and teachers on strategies for using student data to tailor instruction to student learning needs.
- 4. \$592,000 for Sabbatical Leave for Teachers**
Cover costs of teachers on sabbatical leave in lieu of Weighted Student Formula at the school level; collective bargaining requirement.
- 5. \$1,267,700 for Educator Effectiveness System**
Continue statewide implementation of the EES and meet the requirements set by State Board of Education Policy 2055.
- 6. \$217,086 for WASC Accreditation: Administration**
Facilitate ongoing school improvement efforts to achieve and maintain WASC accreditation for all schools in the DOE (EDN 100 also has WASC related request).

HAWAII STATE DEPARTMENT OF EDUCATION
HawaiiPublicSchools.org



18

NUMBER 1: Strive HI, \$2m and 22 temporary FTEs

- These funds will allow personnel to serve necessary support functions (\$1,586,000) for Focus and Priority schools and contracts for support services (\$288,000). It also includes travel (\$126,000) for 15 Complex Area Support Teams to support implementation of the six priority strategies tied to the State Strategic Plan.
- Strive HI is the Department’s new school accountability system that augments portions of the No Child Left Behind (NCLB).
- The latest Strive HI rankings show that the 18 schools in the historically low-performing Zones for School Innovation (ZSI) made significant gains in reading, math and attendance.
- The U.S. DOE and national organizations have begun recognizing Hawaii’s reform efforts and highlighting its policies and practices as national models for excellence. The DOE ZSI were the featured cover story in the December 11 issue of Education Week for its “Pace-setting outcomes.”

NUMBER 2: Digital Curriculum Pilot, \$600,000 and 3 temporary FTEs

- This request includes funds to contract technology support services and provide professional development for the digital pilot schools. Finally, the Department's budget request includes funds to continue to support three positions - 2 positions in Office of Curriculum, Instruction and Student Support (OCISS), charged with providing direct training and support to the schools on technology integration in the classroom and a project manager position to coordinate.

- As of December 2013, all pilot schools were on track to complete their professional development and roll out student devices in January 2014.
- Three of eight pilot schools deployed student devices in the first semester – ahead of schedule.
- Servicing roughly 6,106 students (as of 12/24 Longitudinal Data System (LDS) data) and 448 teachers.
- An overwhelming majority of teachers surveyed reported that the devices will be extremely effective and save them time on day to day tasks such as creating assignments (94%) and planning for instruction (93%).

NUMBER 3: Formative Instruction, \$250,000

- Funds will support school level professional development costs related to transportation, supplies, and state membership to a multi-state working group on formative instruction.
- Formative Instruction - is a powerful and effective teaching strategy. Through formative instruction, teachers in all content areas can collect near real-time information on where students are at in their learning and then use that information to better target delivery of instruction and classroom activities to meet all students needs.

NUMBER 4: Sabbatical Leave, \$592,000

- The State of Hawaii and Hawaii State Teachers Association (HSTA) have reached a four year contractual agreement beginning with SY 2013-2014 through SY 2016-2017, in which the Department is obligated to provide sabbatical leave for teachers.

NUMBER 5: Educator Effectiveness System (EES), \$1,267,700

- Requested funds will provide funding to conduct the student perception survey (\$1,200,000); train and certify new administrators in the classroom observation framework (\$30,000); maintain and modify the PDE3 system (\$5,000); and cover travel expenses (\$32,700).
- The EES is comprised of five components: 1) classroom observations/working portfolios; 2) core professionalism; 3) student perception survey; 4) Hawaii growth model; and 5) student learning objective.

NUMBER 6: WASC Accreditation, \$217,086 and request to transfer 2 permanent FTEs from EDN 100/CB to EDN 200/GB

- The request is to fund 2.0 FTE permanent, unfunded positions to provide administrative support to facilitate school improvement efforts through the accreditation process. The 2.0 permanent FTE counts are appropriated in EDN 100/CB; however, funding for the positions was not appropriated in the budget. As the positions are providing administrative support, they are better suited to be budgeted in the EDN 200 Instructional Support program; therefore, a trade-off/transfer request proposes to move the 2.0 permanent unfunded FTE counts

from EDN 100/CB to EDN 200/GD.

- As of December 2013, 37% of all DOE elementary schools and 100 percent of all DOE middle and high schools have received WASC accreditation. The Department plans to accredit an additional 30 schools/year, to meet the goal of accrediting all DOE schools by 2018.
- An initial review of the first 32 elementary schools to participate in the accreditation process this school year was met with positive feedback from WASC.

Supplemental Requests by Program IDs & Goals

GOAL 1 STUDENT SUCCESS	GOAL 2 STAFF SUCCESS	GOAL 3 SUCCESSFUL SYSTEMS OF SUPPORT
---------------------------	-------------------------	---

EDN 300 – State Administration

1. **\$870,000 for Alternative Teacher Route**
Recruit and provide coursework for candidates to become licensed and effective teachers.
2. **\$599,208 for Professional Development Management System**
Annual subscription for technology platform used to capture, store and prescribe targeted professional development support based upon performance evaluations.
3. **\$300,000 for eHR System**
Technical support services for the Department's core Human Resources Information System.
4. **\$256,000 for Teacher Mentor Program**
Build and monitor high-quality Complex Area teacher induction programs to provide a statewide system of support for beginning teachers (including alternative certification routes), mentors and principals.
5. **\$100,503 for Human Resources position funding**
HR Executive Assistant and related equipment expenses for appropriated position.
6. **\$431,037 for Communications Office position funding**
Funding only, positions are appropriated.



HAWAII STATE DEPARTMENT OF EDUCATION
HawaiiPublicSchools.org

NUMBER 1: Alternative Teacher Route, \$870,000

- Funds will extend the current alternate route teaching contract.
- Since 2011, the Department has partnered with Teach for America (TFA) to recruit and place teachers in high-needs schools and areas. This includes teachers for students with disabilities.
- Over the past two years, TFA has recruited and placed approximately 100 teachers into high-needs schools.
- One third are kama'aina returning back to Hawaii.
- Recent internal analysis shows that TFA teachers have among the highest student survey and growth scores of all in-state teacher prep programs.

NUMBER 2: Professional Development Management System (PDMS), \$599,208

- Funding will maintain the subscription for the PDE3 technology platform, a secure, on-line, portal that connects educators with professional development opportunities tied to their educator effectiveness data.

NUMBER 3: eHR system, \$300,000

- Funding will maintain technical and production support for the existing electronic HR (eHR) system that is business critical to the Department.
- The eHR system is used for the intake of applications, the hiring of employees, payroll processing, and an employee's eventual separation transaction, as well as many other functions unique to the Department.

NUMBER 4: Teacher Mentor Program , \$256,000

- Funding will provide research-based mentor training; beginning teacher, mentor and induction leadership professional development; cross state professional development opportunities; consultation and support to complex areas; training materials; office supplies; and travel.
- Federal Title Ila dollars substantially support the induction and mentoring effort. This is the general fund contribution to ensure support for successful teachers.
- There is a shortage of trained and effective instructional mentors across the state; urgent need to build capacity and increase number of full-release mentors to support approximately 1,600 beginning teachers each year (over 2,500 veteran teachers are eligible for retirement over next 5 years).

NUMBER 5: HR position funding \$100,503

- Funding for the 1.0 FTE permanent, unfunded Executive Assistant position and equipment.
- This is funding need only.
- This position will support the OHR Assistant Superintendent to improve HR support to the field through streamlined recruitment, onboarding and alignment initiatives.

NUMBER 6: Communications Office positions, \$431,037

- The Department's request is to fund 5.0 FTE permanent, unfunded positions and to provide operating funds for the strategic needs of the Department's communications arm. Funding for personal services is required for 5 existing staff positions in the Communications office. The 5.0 permanent FTE counts for the existing staff positions are appropriated; however, funding for salary was not appropriated in the budget.
- Funds for other current expenses are for contractual services to meet the needs of technological advances in communications, neighbor island travel to continue the path of sharing success stories, office equipment, and other operating expenses.
- This is a funding request only for permanent positions in the Communications and Community Affairs office, which supports the executive function of the Superintendent by developing the internal and external communication aspects of the public school system, with an emphasis on promoting the mission, goals and objectives set forth in the Strategic Plan.

Supplemental Requests by Program IDs & Goals

GOAL 1 STUDENT SUCCESS	GOAL 2 STAFF SUCCESS	GOAL 3 SUCCESSFUL SYSTEMS OF SUPPORT
----------------------------------	--------------------------------	--

EDN 300 – State Administration

- 7. \$70,000 for Early Learning Coordinator position and funding**
Position key in connecting early childhood education and DOE programming for children prior to kindergarten entry.
- 8. \$130,360 for Civil Rights Compliance Office positions and funding**
Adequately staff office with two FTEs to manage compliance activities.
- 9. \$36,000 for Council of Chief State School Officers dues**
Annual membership dues to support DOE in reform efforts through multi-state work groups in core strategic areas.
- 10. Office of Information Technology Services positions**
15 permanent positions to improve and align technology support.

EDN 400 – School Support

- 1. \$9,000,000 for Utilities**
To account for a projected shortfall in the utility budget, which covers the cost of electricity, gas, water and sewer expenses.

HAWAII STATE DEPARTMENT OF EDUCATION
HawaiiPublicSchools.org



20

NUMBER 7: Early Learning Coordinator, \$70,000 and 1.0 permanent FTE

- Funds will create a position to support early childhood education. The position will be responsible for policies, curriculum, and assessment relating to kindergarten and other pre-kindergarten programs.
- The Early Learning coordinator connects the early childhood education and DOE programming for children prior to Kindergarten entry promoting a continuum that promotes our vision of career and college readiness.

NUMBER 8: Civil Rights Compliance Office positions, \$130,360 and 2.0 temporary FTEs

- The request for 2.0 FTE temporary Civil Rights Compliance Specialist II positions will result in two more dedicated positions to address the most immediate needs of the department with respect to civil rights compliance in the area of Title VI and federal audits.

NUMBER 9: CCSSO dues, \$36,000

- The Council of Chief State School Officers (CCSSO) is a membership organization for the nation's chief state school officers leading state education agencies. CCSSO convenes members for professional development and peer networking throughout the year.
- In the past year, Hawaii has participated in at least seven state collaboration sessions, sponsored by CCSSO. Participation has impacted implementation of Hawaii's Common Core, development of the Smarter Balanced assessment

system, supports for math educators, and policies and procedures for education information management.

NUMBER 10: OITS positions, 15.0 permanent FTEs (no funds)

- 1.0 DPSA V for the Network Design Section; 3.0 DPSA IV positions to support school level technology integration; 7.0 IT Specialist III to improve the quality and responsiveness of information technology services and support to the schools, complex areas, and state administrative; 1.0 DPSA IV to fulfill the role of the Information Systems Training Unit (ISTU) Head; 1.0 DPSA VI for to Data Management Section to lead database development, administration, and maintenance; and 2.0 DPSA IV to provide programming/integration for educational technology systems and the development maintenance, administration, and management of all School systems.
- As the Department moves toward providing students with 21st century learning environments, and system-wide high-speed internet in all schools, there is a shortage of internal IT capacity AND need for Complex Area technology support.
- The Department's Office of Information Technology Services (OITS) recently completed the first-ever major restructuring of the IT office, which involved the creation of several new functions such as Enterprise Architecture, Customer Service and Project Management.

EDN 400: SCHOOL SUPPORT, NUMBER 1, UTILITIES

- Funds will cover shortfall based on forecasted savings from PV install and sustainability initiatives that were anticipated when the biennium was submitted but are not being realized.
- Electric consumption at school level is trending flat, or in some cases downward due to continued conservation efforts. However, rates continue to increase in electric, water and sewer plus additional more systems (buildings) coming on line the DOE will continue to see an upward trend in utility expenditure.
- Photovoltaic pilots and other energy sustainability initiatives are key to the DOE's efforts in mitigating rising costs of powering our schools.

Funding Requests Aim to Achieve Strategic Goals

GOAL 1 STUDENT SUCCESS	GOAL 2 STAFF SUCCESS	GOAL 3 SUCCESSFUL SYSTEMS OF SUPPORT
\$17,594,924	\$3,985,411	\$10,139,483
		
<i>Promote excellence in student learning.</i>	<i>Enhance professional development and support.</i>	<i>Strengthen capacity to improve services to students and schools.</i>

HAWAII STATE DEPARTMENT OF EDUCATION
HawaiiPublicSchools.org



21

The Department is moving forward on its goals at a fast pace and while we've made gains made over the past two years it is taking a toll on our educators. The DOE made extraordinary progress in our efforts to transform Hawaii's public school system, this requires a budget that is focused on DOE's strategic goals.

Other Economic & Fiscal Risks

Federal Budget

- How will Congress establish appropriations by federal program?
- How and when will federal agencies provide estimated allocations to states?

Utilities

- Will the Hawaiian Electric Companies infrastructure be able to accommodate the potential photo voltaic (PV) energy production capacity from schools?

Student Transportation

- Will full implementation of pilot model result in the predicted savings?

Special Education

- How many additional eligible students will opt to continue to receive educational services to age 22?

Enrollment

- Will student enrollment counts be higher/lower than estimated?





CIP Budget

HAWAII STATE DEPARTMENT OF EDUCATION

HawaiiPublicSchools.org



23

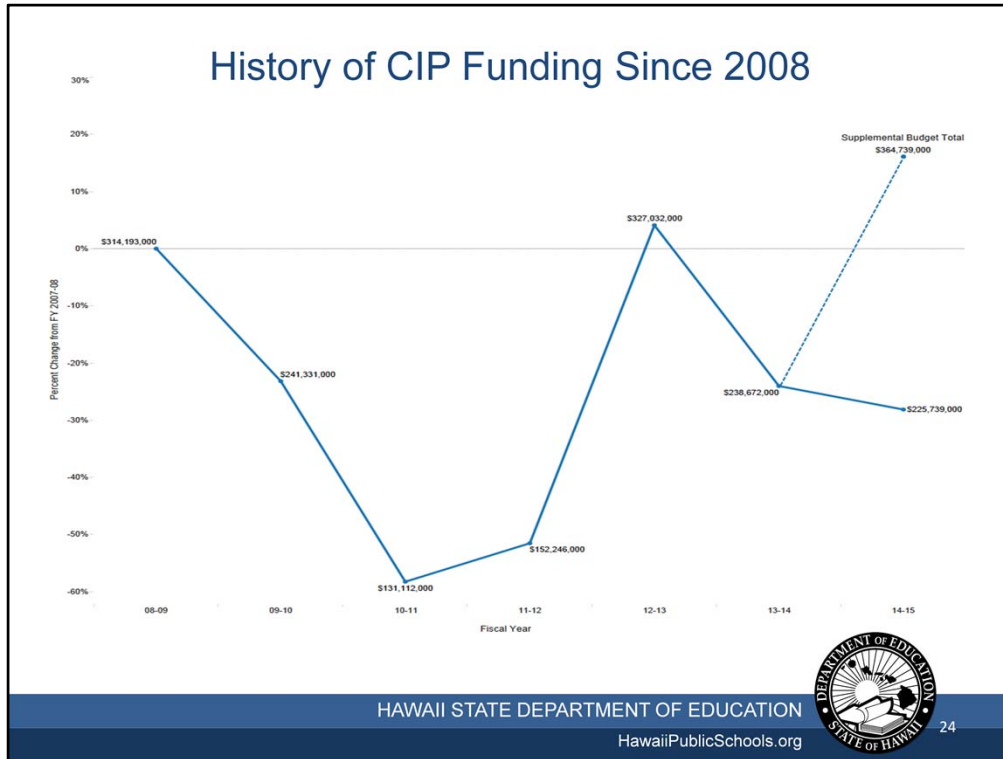

TOTAL FUNDING: Since 2008, the DOE has received a total of \$1,408,585,000 (1.4 billion). This works out to an average of \$234,764,416 per year.

Funding levels however, varied from a high of \$327 million in 2012 down to \$131 million in 2010. This fluctuation in funding makes it more of a challenge to plan out and budget for needed new facilities and repairs to existing facilities.

With the funding provided, the DOE has been able to:

- Open a new elementary school on Maui (Puu Kukui)
- Award a design/build contract for a new elementary school on Oahu (Kapolei II) – start this summer
- Reduce the Repair & Maintenance Backlog by \$156 million
- Complete a new cafeteria at Lahainaluna High School
- Complete a new classroom building at Campbell High
- Complete a new classroom building at Lanai High
- Complete a new administration building at Kalaheo Elementary
- Complete a new cafeteria at Paia Elementary
- Complete a new Locker/Shower building at Kalakaua Middle
- Construct a new classroom building at Keaau Middle (under construction)
- Girls Locker/Shower building at McKinley High
- New classroom building at Waipahu Elementary (under construction)
- New cafeteria at Keaukaha Elementary (under construction)
- New Science Center at Stevenson Middle (under construction)
- New Science Lab building at Kailua High (under construction)
- New Administration building at Hickam Elementary (under construction)
- Campus Wide A/C at Hickam and Pohakea Elementary Schools
- Electrical Upgrades at various school statewide

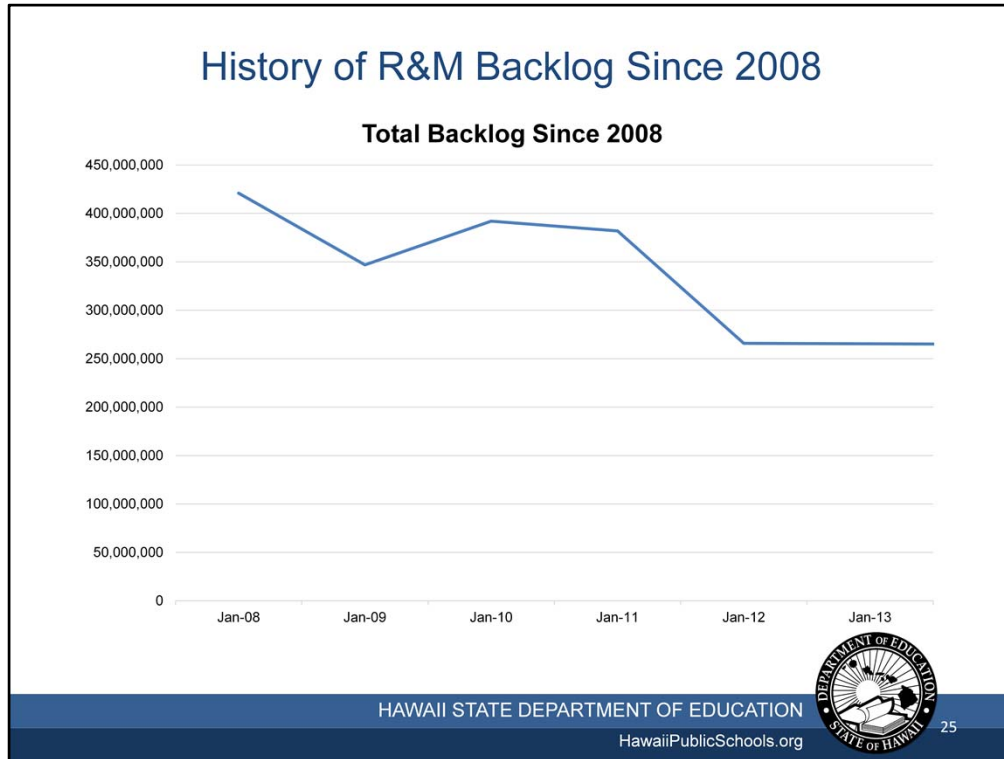

In 2001 the R&M backlog was over \$700 million. Since then, the DOE has managed, thanks to the funding it has received, to reduce the backlog from its high point in 2001 down to \$265 million in September 2013.

Put another way, while the average backlog per school equaled more than \$2.8 million, this had dropped to \$1.03 million per school by September 2013.

This represents a reduction of nearly 1/3.

While most of these projects covered roofing and other repairs, recently, there has been a move towards more system upgrade projects including electrical upgrades and the major system-wide converged infrastructure, combining more than five previously separate systems into a single unified system on a single platform.

The DOE estimates that \$150 million is the 'steady state' level for the R&M backlog as it reflects approximately two year's of additions to the backlog.

Key CIP Performance Indicators

<p>Condition</p> <ul style="list-style-type: none">• Repair & Maintenance• Electrical/Technology Infrastructure• Hazardous Material Removal• Health & Safety• Structural Improvements	<p>Program Support</p> <ul style="list-style-type: none">• Science Facilities• Special Education• Physical Education• New Restrooms• Support Program Spaces
<p>Capacity</p> <ul style="list-style-type: none">• New Schools• Classroom Additions• Temporary Facilities• Repurposing existing to create capacity	<p>Equity</p> <ul style="list-style-type: none">• Gender Equity• Noise/Heat Abatement• ADA Compliance• Playground Equipment• Energy Improvement• Right-sizing of spaces



HAWAII STATE DEPARTMENT OF EDUCATION
HawaiiPublicSchools.org



26

Per the request of the legislature, the Department has categorized where the DOE is spending into four of these “lump sums.”

Supplemental CIP Request Summary

	(1) FY 13-14 Act 134/13	(2) FY 14-15 Act 134/13	(3) FY 14-15 DOE Supplemental Budget Request	(4) FY 14-15 DOE Supplemental Budget Total	(4-1) / (1) % Change FY13-14 (Act 134) to FY14-15 Supplemental Budget Total
Condition	72,826,000	20,000,000	51,500,000	71,500,000	-0.018%
Capacity	16,750,000	20,000,000	1,500,000	21,500,000	2.8 %
Program Support	22,624,000	4,000,000	12,000,000	16,000,000	-0.29 %
Equity	22,400,000	10,000,000	14,000,000	24,000,000	0.07 %
Other *	104,872,000	171,739,000	85,000,000	256,739,000	1.45 %
Total	238,672,000	225,739,000	164,000,000	364,739,000	0.52 %

** Includes proposed funding for Solomon Elementary School in which an estimated \$48 million will be federal funds.*



HAWAII STATE DEPARTMENT OF EDUCATION
HawaiiPublicSchools.org

The DOE’s Supplemental CIP request reflects what the department believes is the minimum level of funding necessary to maintain recent improvements and to not ‘fall behind’.

Condition: The Condition KPI covers such work as routine repairs such as reroofing, but also includes electrical upgrade projects, and whole school classroom renovations. For example: converged infrastructure for IT (5 systems into 1)

Capacity: The Capacity KPI covers new classroom capacity but also renovations and repurposing of facilities into classroom capacity. Also included are temporary classroom facilities. With funding, the DOE plans to build 5 new classroom buildings = 3 on Big Island (Nahienaena ES, Waikoloa ES, Kealekehe ES) and 2 on Maui (Lahainaluna HS and Lahainaluna IS)

Program Support: The Program Support KPI includes ADA (various) and Gender compliance (2), and Athletic (3) and other Support Facilities (5). For example: Improvements to the girls athletic locker room at Kahuku HS.

Equity: The Equity KPI includes such projects as High School Science Classroom Upgrades to meet new requirements, Special Education classroom renovations, and Farrington High’s Long Range Campus Improvements.

*Note: Referring to CIP budget spreadsheet for individual examples.

Hawaii State Department of Education

Search Entire Site

27 School Calendar Find Schools Site Map

Vision for Success Transforming Schools & Results

Teaching & Learning Curriculum, Instruction & Testing

Beyond the Classroom Student Programs & Services

Parents & Students Resources & Tools

Connect with Us About the Department

Path to Graduation
What students need to do to earn a diploma from Hawaii's public high schools.

Lunch program
Nationally balanced, low cost or free lunches are available to qualifying children.

Teacher training
Learn about our system of educator evaluations, mentoring and training.

Athletics
The Department offers 20 interscholastic sports each school year -- and more.

Common Core Curriculum
English Language Arts and Literacy in History, Science, Technical Subjects and Math.

The Strategic Plan

Strive HI System

Testing

HawaiiPublicSchools.org

Stay up to date with Department News [Subscribe ▶](#)

/HIDepartmentofEducation @HIDOE808

28

Race to the Top Projects Included in Strategic Plan				GOAL 1 STUDENT SUCCESS
Project	Program ID/Org	Total RTTT Funds	Included in Supplemental?	Sustainability Plans
Assessment Literacy/Functional Analysis and Data Teams	EDN200/GC	\$6,324,202 • CAST salary, travel, contract	\$250,000 • Resource development • Travel/equipment for CAST	Formative Instruction/Data Teams is one of 6 Priority Strategies
Hawaii Common Core standards implementation		\$2,496,042 • Travel, School Sub Days, Stipends, TCEs, Supplies, Clerical Support	No — prioritization of existing funding sources	The Department plans to continue implementation of the standards, one of the 6 Priority Strategies
Continuum of Proactive Student Supports for Early Intervention and Prevention		\$10,000 contract	No — prioritization of existing funding sources	This is part of the Comprehensive Student Support System, one of the 6 Priority Strategies
College and Career Ready Diploma implementation		None	No — prioritization of existing funding sources	The CCR Diploma requirements begin with the Class of 2016
Interim and Summative Assessments		None	No — prioritization of existing funding sources	Smarter Balanced assessments will replace the Hawaii State Assessment in reading and math
End of Course Assessments		\$5,071,945 • Contract, travel, supplies	No — prioritization of existing funding sources	Continued implementation of the End of Course exams
STEM Learning Strategy and Network		\$1,013,037 for staff	No — prioritization of existing funding sources	The 2013-14 CAST RTs will develop a recommended statewide strategy for STEM education
Zones of School Innovation: Turning Around the Lowest Achieving Schools	EDN200/GD	\$18,494,596 • Staff, services to schools, contract, training, travel, supplies	\$2,000,000 • Staff, rewards to schools, services to schools	The Zones of School Innovation project will become the work of the proposed Office of School Transformation to support and turn around Focus and Priority Schools

Race to the Top Projects Included in Strategic Plan				GOAL 2 STAFF SUCCESS
Project	Program ID/Org	Total RTTT Funds	Included in Supplemental?	Sustainability Plans
Alternative Certification for Teachers and Principals	EDN300/ KO	\$3,011,424 • Contract, travel, supplies	\$870,000 • Contract	The Department plans to continue to leverage alternative routes for certifying teachers
Educator Effectiveness System	EDN200/ GD	\$10,324,537 • Staff, contract, travel, supplies	\$1,267,700 • Training • Contract	The Educator Effectiveness System is one of the 6 Priority Strategies
Induction and Mentoring	EDN300/ KO	\$4,335,228 • Staff, contract, travel, supplies	\$256,000 • Training	Induction and Mentoring is one of the 6 Priority Strategies
Professional Development Management System	EDN300/ KO	\$1,898,236 • Staff, contract, travel	\$599,208 • Contract	The Department plans to continue to strengthen Professional Development Management System to support Educator Effectiveness.
Equitable Distribution of Teachers and Principals		\$3,042,252 • Staff, contract, travel, supplies	No — prioritization of existing funding sources	The Department plans to propose a strategy for improving the Hawaii Virtual Learning Network in advance of the Biennium Budget request
Improving Effectiveness of Educator Preparation Programs		\$100,000 contract	No — prioritization of existing funding sources	The Department will continue to work with higher education to improve the quality of preparation programs, but will no longer require an outside consultant

Race to the Top Projects Included in Strategic Plan				GOAL 3 SUCCESSFUL SYSTEMS OF SUPPORT
Project	Program ID/Org	Total RTTT Funds	Included in Supplemental?	Sustainability Plans
Community Engagement	EDN300/ KD	\$331,880 • Staff, travel	\$431,037 • Staff, supplies and equipment (website)	A key component of communications efforts and the Communications and Community Affairs Office
Race to the Top External Evaluation		\$2,000,000 • Contract	No	Project complete upon conclusion of grant
Academic and Financial Plan (Ac-Fin) and State Strategic Plan		\$271,152 • Contract, travel	No — prioritization of existing funding sources	The State Strategic Plan is complete. The Department will continue to refine the Ac-Fin templates to meet school, Complex Area and State needs
Federal Programs Alignment		None	No — prioritization of existing funding sources	The Department will continue to allocate federal funds in alignment with strategic plan goals as part of standard budget practice
Community Access Portal		\$1,707,686 • Contract	No — prioritization of existing funding sources	The Department website and internal portal upgrades will be complete upon conclusion of the grant
Reorganization of Offices		\$3,644,082 • Staff, contract, supplies, travel	No	Complete upon conclusion of grant
Longitudinal Data System (LDS)/HPERC		\$2,367,334 • Staff, contract, supplies, travel	No — prioritization of existing funding sources	The Department will continue to use/refine the LDS for support key reform efforts. HPERC will also continue
Single Sign-On (SSO)		\$2,071,832 • Contract	No — prioritization of existing funding sources	The SSO project will be complete upon conclusion of the grant
Network Work Plan		\$2,664,810 • Contract	No — prioritization of existing funding sources	The internet upgrades will be complete upon conclusion of the grant

HAWAII STATE DEPARTMENT OF EDUCATION

HawaiiPublicSchools.org

Department of Education
 Prioritized List of Functions

Table 1

<u>Priority</u>	<u>Description of Function</u>	<u>Activities</u>	<u>Prog ID(s)</u>	<u>Statutory Reference</u>
1	Student Success - All students demonstrate they are on a path toward success in college, career and citizenship.	Classroom Instruction	EDN 100 EDN 500	HRS §302A (multiple sections)
		Categorical Programs - i.e. At-Risk Programs, Student Activities, Athletics, Drivers Education, JROTC, Hawaiian Programs	EDN 100	
		Student Assessment	EDN 200	
		Special Education Services	EDN 150	
		Community School for Adults	EDN 500	
2	Staff Success - The Department has a high-performing culture where employees have the training, support and professional development to contribute effectively to student success.	Professional Development	EDN 100 EDN 150 EDN 200 EDN 300 EDN 400 EDN 500	HRS §302A (multiple sections)
		Sabbatical Leave Programs	EDN 200	
		Training and Retention Program	EDN 150	
		Complex Area Support	EDN 200	
		Curriculum, Instruction, and Student Support	EDN 150 EDN 200	
3	Successful Systems of Support - The system and culture of the Department work to effectively organize financial, human, and community resources in support of student success.	Executive Leadership - Board of Education and Office of the Superintendent	EDN 300	HRS §302A (multiple sections)
		Fiscal Services - Budgeting, Accounting, and Procurement	EDN 300	
		Human Resources - Personnel Management, Personnel Development, and Workers Compensation,	EDN 300	
		Information Technology - Network Support, Data, and System Services	EDN 300	
		School Facilities Support - R&M, Transportation, Utilities, Food Services	EDN 400	

Department of Education
Department Totals

Table 2

Fiscal Year 2014				
Act 134/13 Appropriation	Restriction	Emergency Appropriations	Total FY14	MOF
1,399,913,038			1,399,913,038	A
55,959,324			55,959,324	B
241,262,560			241,262,560	N
17,988,189			17,988,189	P
24,290,000			24,290,000	T
10,545,605			10,545,605	U
28,834,438			28,834,438	W
\$ 1,778,793,154	\$ -	\$ -	\$ 1,778,793,154	Total
Fiscal Year 2015				
Act 134/13 Appropriation	Reductions	Additions	Total FY15	MOF
1,367,369,920		31,719,818	1,399,089,738	A
55,959,324			55,959,324	B
233,651,324			233,651,324	N
17,343,500			17,343,500	P
24,290,000			24,290,000	T
10,545,605			10,545,605	U
28,834,438			28,834,438	W
\$ 1,737,994,111	\$ -	31,719,818	\$ 1,769,713,929	Total

Department of Education
Program ID Totals

Table 3

Prog ID	Program Title	MOF	As appropriated by Act 134/13 (FY14)			Governor's Submittal (FY15)			Percent Change of \$\$\$\$
			Pos (P)	Pos (T)	\$\$\$	Pos (P)	Pos (T)	\$\$\$	
EDN 100	SCHOOL BASED BUDGETING	A	12,561.35	678.30	817,507,508	12,559.35	678.30	809,398,844	-0.99%
EDN 100	SCHOOL BASED BUDGETING	B			7,230,000			7,230,000	0.00%
EDN 100	SCHOOL BASED BUDGETING	N			128,498,907			128,093,714	-0.32%
EDN 100	SCHOOL BASED BUDGETING	P			17,678,689			17,034,000	-3.65%
EDN 100	SCHOOL BASED BUDGETING	T			20,290,000			20,290,000	0.00%
EDN 100	SCHOOL BASED BUDGETING	U			3,995,605			3,995,605	0.00%
EDN 100	SCHOOL BASED BUDGETING	W			3,389,438			3,389,438	0.00%
EDN 100 Total			12,561.35	678.30	998,590,147	12,559.35	678.30	989,431,601	
EDN 150	SPECIAL EDUCATION AND STUDENT SUPPORT SERVICES	A	5,173.63	1,229.25	321,843,969	5,173.63	1,229.25	321,843,969	0.00%
EDN 150	SPECIAL EDUCATION AND STUDENT SUPPORT SERVICES	B			100,000			100,000	0.00%
EDN 150	SPECIAL EDUCATION AND STUDENT SUPPORT SERVICES	N	2.00	31.00	49,338,081	2.00	31.00	49,338,081	0.00%
EDN 150	SPECIAL EDUCATION AND STUDENT SUPPORT SERVICES	P	-	2.00	92,500	-	2.00	92,500	0.00%
EDN 150	SPECIAL EDUCATION AND STUDENT SUPPORT SERVICES	W	4.00	-	3,500,000	4.00	-	3,500,000	0.00%
EDN 150 Total			5,179.63	1,262.25	374,874,550	5,179.63	1,262.25	374,874,550	
EDN 200	INSTRUCTIONAL SUPPORT	A	377.00	59.00	45,120,095	379.00	84.00	49,059,134	8.73%
EDN 200	INSTRUCTIONAL SUPPORT	B	11.00	-	2,321,746	11.00	-	2,321,746	0.00%
EDN 200	INSTRUCTIONAL SUPPORT	N	-	2.00	500,000	-	2.00	500,000	0.00%
EDN 200	INSTRUCTIONAL SUPPORT	P	-	1.00	187,000	-	1.00	187,000	0.00%
EDN 200	INSTRUCTIONAL SUPPORT	U			250,000			250,000	0.00%
EDN 200 Total			388.00	62.00	48,378,841	390.00	87.00	52,317,880	
EDN 300	STATE ADMINISTRATION	A	446.50	10.00	42,276,161	462.50	12.00	45,069,269	6.61%
EDN 300	STATE ADMINISTRATION	P			30,000			30,000	0.00%
EDN 300 Total			446.50	10.00	42,306,161	462.50	12.00	45,099,269	
EDN 400	SCHOOL SUPPORT	A	637.00	3.00	170,665,305	637.00	3.00	171,218,522	0.32%
EDN 400	SCHOOL SUPPORT	B	726.50	6.00	42,676,578	726.50	6.00	42,676,578	0.00%
EDN 400	SCHOOL SUPPORT	N	3.00	112.50	59,659,032	3.00	112.50	52,452,989	-12.08%
EDN 400	SCHOOL SUPPORT	W	4.00	2.00	10,950,000	4.00	2.00	10,950,000	0.00%
EDN 400 Total			1,370.50	123.50	283,950,915	1,370.50	123.50	277,298,089	
EDN 500	SCHOOL COMMUNITY SERVICES	A	29.00	5.00	2,500,000	29.00	5.00	2,500,000	0.00%
EDN 500	SCHOOL COMMUNITY SERVICES	B			3,631,000			3,631,000	0.00%
EDN 500	SCHOOL COMMUNITY SERVICES	N	-	2.00	3,266,540	-	2.00	3,266,540	0.00%
EDN 500	SCHOOL COMMUNITY SERVICES	T			4,000,000			4,000,000	0.00%
EDN 500	SCHOOL COMMUNITY SERVICES	U			6,300,000			6,300,000	0.00%
EDN 500	SCHOOL COMMUNITY SERVICES	W			10,995,000			10,995,000	0.00%
EDN 500 Total			29.00	7.00	30,692,540	29.00	7.00	30,692,540	

Department of Education
Program ID Totals

Table 3

Prog ID	Program Title	MOF	As appropriated by Act 134/13 (FY14)			Governor's Submittal (FY15)			Percent Change of \$\$\$\$
			Pos (P)	Pos (T)	\$\$\$	Pos (P)	Pos (T)	\$\$\$	
Grand Total			19,974.98	2,143.05	1,778,793,154	19,990.98	2,170.05	1,769,713,929	
Totals by MOF		A	19,224.48	1,984.55	1,399,913,038	19,224.48	2,011.55	1,399,089,738	-0.06%
		B	737.50	6.00	55,959,324	737.50	6.00	55,959,324	0.00%
		N	5.00	147.50	241,262,560	5.00	147.50	233,651,324	-3.15%
		P	-	3.00	17,988,189	-	3.00	17,343,500	-3.58%
		T	-	-	24,290,000	-	-	24,290,000	0.00%
		U	-	-	10,545,605	-	-	10,545,605	0.00%
		W	8.00	2.00	28,834,438	8.00	2.00	28,834,438	0.00%
GRAND TOTAL			19,974.98	2,143.05	1,778,793,154	19,974.98	2,170.05	1,769,713,929	

Department of Education
Budget Request Decisions

Table 4

Prog ID	Description of Request	MOF	Initial Department Request			Initial Budget & Finance Recommendation			Governor's Final Decision		
			Pos (P)	Pos (T)	\$\$\$	Pos (P)	Pos (T)	\$\$\$	Pos (P)	Pos (T)	\$\$\$
EDN 100	WASC Accreditation - to transfer 2.0 permanent FTEs from EDN 100/CB to EDN 200/GD to provide administrative support to facilitate school improvement efforts through the WASC accreditation process.	A	(2.00)			(2.00)			(2.00)		
EDN 200	WASC Accreditation - to transfer 2.0 permanent FTEs from EDN 100/CB to EDN 200/GD to provide administrative support to facilitate school improvement efforts through the WASC accreditation process.	A	2.00			2.00			2.00		
EDN 300	OITS Position - to transfer 1.0 permanent FTE from the Office of Human Resources (EDN 300/KO) to Office of Information Technology Services (EDN 300/UA) to ensure the successful implementation of IT solutions, infrastructure upgrades and replacements.	A	(1.00)			(1.00)			(1.00)		
EDN 300	OITS Position - to transfer 1.0 permanent FTE from the Office of Human Resources (EDN 300/KO) to Office of Information Technology Services (EDN 300/UA) to ensure the successful implementation of IT solutions, infrastructure upgrades and replacements.	A	1.00			1.00			1.00		
EDN 100	Weighted Student Formula - increase in base funding at each school to help address: funding adequacy at all schools and the additional demands being placed on school staff around implementation of educator effectiveness, student data assessment, induction and mentoring, Elementary and Secondary Education Act (ESEA) Flex, information technology support, and Hawaii Common Core standards.	A			20,000,000			14,000,000			14,000,000
EDN 100	High Core / Storefront - operating expenses, instructional materials, and funding for (8) part-time teachers and a counselor to allow for an extended day and night school program.	A			120,545			120,545			120,545
EDN 100	Advanced Placement - operating expenses and funding for 1.0 permanent state level resource teacher position to help administer student support programs.	A	-		554,379			554,379			554,379
EDN 100	WASC Accreditation - operating expenses including substitute teachers, membership fees, and visitation expenses to facilitate school improvement efforts through the accreditation process.	A			265,000			265,000			265,000

Department of Education
Budget Request Decisions

Table 4

Prog ID	Description of Request	MOF	Initial Department Request			Initial Budget & Finance Recommendation			Governor's Final Decision		
			Pos (P)	Pos (T)	\$\$\$	Pos (P)	Pos (T)	\$\$\$	Pos (P)	Pos (T)	\$\$\$
EDN 100	Strive HI - to expand existing services to support data validation work and yearly processing and modifying ESEA accountability analyses and reports.	A			60,000			60,000			60,000
EDN 150	SPED beyond age 20 - operating funds to cover the cost of servicing special education students beyond the age of 20.	A			1			-			-
EDN 200	Formative Instruction - operating funds to support school level professional development costs related to transportation, supplies, and state membership to a multi-state working group on formative instruction.	A			250,000			250,000			250,000
EDN 200	WASC Accreditation - Request for operating funds and funding for 2.0 appropriated but unfunded permanent positions to provide administrative services to facilitate school improvement efforts through the accreditation process.	A			217,086			217,086			217,086
EDN 200	Strive HI - for 22.0 temporary positions and funds to serve necessary support functions for Focus and Priority schools and contracts for support services.	A		22.00	3,091,568		22.00	2,000,000		22.00	2,000,000
EDN 200	Education Effectiveness System (EES) - for the student perception survey, train and certify administrators on the classroom observation framework, maintain and modify the PDE3 system, and travel expenses.	A			1,267,700			1,267,700			1,267,700
EDN 200	Sabbatical Leave - to meet the Department's obligation to provide sabbatical leaves per the HSTA contract.	A			592,000			592,000			592,000
EDN 300	Board of Education - to fully fund personnel (3.0 permanent positions) and operating expenses for the Board of Education support office.	A			100,435			-			-
EDN 300	Council of Chief State School Officers (CCSSO) - to cover the cost of annual membership in organization for the nation's chief state school officers leading state educational agencies.	A			36,000			-			36,000
EDN 300	Communications and Community Affairs Office - to fund personnel (5.0 permanent positions) and operating expenses for the strategic needs of the Department's communication arm.	A			431,037			431,037			431,037
EDN 300	Internal Audit - to fund personnel (8.0 permanent positions) and operating expenses for the Internal Audit Office.	A			266,112			-			-

Department of Education
Budget Request Decisions

Table 4

Prog ID	Description of Request	MOF	Initial Department Request			Initial Budget & Finance Recommendation			Governor's Final Decision		
			Pos (P)	Pos (T)	\$\$\$	Pos (P)	Pos (T)	\$\$\$	Pos (P)	Pos (T)	\$\$\$
EDN 300	Civil Rights Compliance Office - for (2.0) temporary FTEs to assist in meeting the most immediate needs of the Department with respect to compliance in the area of Title VI of the Civil Rights Act and federal audits.	A		2.00	130,360		2.00	130,360		2.00	130,360
EDN 300	Teacher Mentor Program - to provide research-based mentor training; beginning teacher, mentor, and induction leadership professional development; cross state professional development opportunities; consultation and support complex areas; training materials; office supplies; and travel.	A			256,000			256,000			256,000
EDN 300	Alternative Teacher Route - to extend the current alternative route teaching contract to recruit and place teacher candidates.	A			870,000			870,000			870,000
EDN 300	Professional Development Management System (PDMS) - to maintain the subscription for the PDE3 technology platform, a secure, on-line, portal that connects educators with professional development opportunities tied to their education effectiveness data.	A			599,208			599,208			599,208
EDN 300	Electronic Human Resources (eHR) - to maintain technical production support for the existing system that is business critical to the Department.	A			403,000			300,000			300,000
EDN 300	HR Executive Assistant - to fund position to improve HR support to the field through streamlined recruitment, onboarding and alignment initiatives.	A			100,503			100,503			100,503

Department of Education
Budget Request Decisions

Table 4

Prog ID	Description of Request	MOF	Initial Department Request			Initial Budget & Finance Recommendation			Governor's Final Decision		
			Pos (P)	Pos (T)	\$\$\$	Pos (P)	Pos (T)	\$\$\$	Pos (P)	Pos (T)	\$\$\$
EDN 300	OITS positions - for 15.0 Permanent FTEs for the Office of Information Technology Services: 1.0 DPSA V for the Network Design Section; 3.0 DPSA IV positions to support school level technology integration; 7.0 IT Specialist III to improve the quality and responsiveness of information technology services and support to the schools, complex areas, and state administrative; 1.0 DPSA IV to fulfill the role of the Information Systems Training Unit (ISTU) Head; 1.0 DPSA VI for to Data Management Section to lead database development, administration, and maintenance; and 2.0 DPSA IV to provide programming/integration for educational technology systems and the development maintenance, administration, and management of all School systems.	A	15.00			15.00			15.00		
EDN 400	Utilities - to account for the projected shortfall in the utility budget, which covers the cost of electricity, gas, water and sewer expenses.	A			10,600,000			9,000,000			9,000,000
EDN 300	Early Learning Coordinator - to fund position to support early childhood education policies, curriculum, and assessment relating to kindergarten and other pre-kindergarten programs.	A				1.00		70,000	1.00		70,000
NA	Vision/Hearing Screening Program	A						1,500,000			
EDN 200	Digital Curriculum Pilot - to contract technology support services and provide professional development for the digital pilot schools.	A						600,000		3.00	600,000
FY 15 SUPPLEMENTAL BUDGET REQUEST TOTAL			15.00	24.00	40,210,934	16.00	24.00	33,183,818	16.00	27.00	31,719,818

Department of Education
Proposed Budget Reductions

Table 5

<u>Prog ID</u>	<u>Description of Reduction</u>	<u>Impact of Reduction</u>	<u>MOF</u>	<u>Pos (P)</u>	<u>Pos (T)</u>	<u>\$\$\$</u>	<u>Carry-over?</u> <u>(Y/N)</u>
	None.						

Department of Education
Proposed Budget Additions

Table 6

<u>Prog ID</u>	<u>Request Category</u>	<u>Prog ID Priority</u>	<u>Dept- Wide Priority</u>	<u>Description of Addition</u>	<u>Justification</u>	<u>MOF</u>	<u>Pos (P)</u>	<u>Pos (T)</u>	<u>\$\$\$</u>
EDN 100	ND	1	1	Weighted Student Formula - increase in base funding at each school to help address: funding adequacy at all schools and the additional demands being placed on school staff around implementation of educator effectiveness, student data assessment, induction and mentoring, Elementary and Secondary Education Act (ESEA) Flex, information technology support, and Hawaii Common Core standards.	Schools have indicated that WSF is transparent, predictable and equitable but NOT adequate, as outlined in a study done by 3 rd party to help inform the Committee on Weights. This request will provide the approximate "value" of a teacher position while maintaining a principal's autonomy to add resources where they will positively impact student achievement the most. These resources could be added to bolster resources in the 6 Priority Strategies.	A			14,000,000
EDN 100	RR	1	1	High Core / Storefront - operating expenses, instructional materials, and funding for (8) part-time teachers and a counselor to allow for an extended day and night school program.	Pursuant to Section 18 of Act 134, Session Laws of Hawaii 2013, \$535,423 shall be expended in both FY 2013-14 and FY 2014-15 for the operation of the high core (storefront) alternative learning center. As the program has set aside only \$414,878 in FY 2013-14 and FY 2014-15 for operation of the high core ALC, an additional \$120,545 is needed to meet the requirements of the budget proviso in Act 134. The additional funds will provide for eight Part Time Teachers (PTTs) and a counselor for the extended day and night school component of their services.	A			120,545
EDN 100	RR	1	1	Advanced Placement - operating expenses and funding for 1.0 permanent state level resource teacher position to help administer student support programs.	The requested operating funds will provide services to increase student achievement in AP courses through AP Saturday prep sessions, Brain Camp, AP mock exams, training for administrators and counselors, and other professional development activities.	A			554,379
EDN 100	RR	1	1	WASC Accreditation - operating expenses including substitute teachers, membership fees, and visitation expenses to facilitate school improvement efforts through the accreditation process.	The requested operating funds will facilitate school improvement efforts through the accreditation process and the implementation of the State Strategic Plan, Academic and Financial Plans, and to prepare schools for the on-site accreditation visit by providing appropriate technical assistance and training activities for school leaders and school staff.	A			265,000

Department of Education
Proposed Budget Additions

Table 6

<u>Prog ID</u>	<u>Request Category</u>	<u>Prog ID Priority</u>	<u>Dept- Wide Priority</u>	<u>Description of Addition</u>	<u>Justification</u>	<u>MOF</u>	<u>Pos (P)</u>	<u>Pos (T)</u>	<u>\$\$\$</u>
EDN 100	RR	1	1	Strive HI - to expand existing services to support data validation work and yearly processing and modifying ESEA accountability analyses and reports.	The new Strive HI Performance System takes into account multiple measures of a school's performance, as opposed to just the test results from that year. This means an increase in the quantity and complexity of data collection and analysis.	A			60,000
EDN 200	RR	1	1	Formative Instruction - operating funds to support school level professional development costs related to transportation, supplies, and state membership to a multi-state working group on formative instruction.	Formative Instruction - is a powerful and effective teaching strategy. Through formative instruction, teachers in all content areas can collect near real-time information on where students are at in their learning and then use that information to better target delivery of instruction and classroom activities to meet all students needs.	A			250,000
EDN 200	RR	1	1	WASC Accreditation - Request for operating funds and funding for 2.0 appropriated but unfunded permanent positions to provide administrative services to facilitate school improvement efforts through the accreditation process.	These funds will facilitate school improvement efforts through the accreditation process and the implementation of the State Strategic Plan, Academic and Financial Plans, and to prepare schools for the on-site accreditation visit by providing appropriate technical assistance and training activities for school leaders and school staff. In addition, the Department will alleviate the school level cost burden of WASC accreditation by centralizing the purchase of the WASC subscription. This also allows for the state to realize savings by creating economies of scale.	A			217,086
EDN 200	RR	1	1	Strive HI - for 22.0 temporary positions and funds to serve necessary support functions for Focus and Priority schools and contracts for support services.	These funds will allow personnel to serve necessary support functions (\$1,586,000) for Focus and Priority schools and contracts for support services (\$288,000). It also includes travel (\$126,000) for 15 Complex Area Support Teams to support implementation of the six priority strategies tied to the State Strategic Plan.	A		22.00	2,000,000
EDN 200	O	1	1	Education Effectiveness System (EES) - for the student perception survey, train and certify administrators on the classroom observation framework, maintain and modify the PDE3 system, and travel expenses.	The EES is comprised of five components: 1) classroom observations/working portfolios; 2) core professionalism; 3) student perception survey; 4) Hawaii growth model; and 5) student learning objective.	A			1,267,700

Department of Education
Proposed Budget Additions

Table 6

<u>Prog ID</u>	<u>Request Category</u>	<u>Prog ID Priority</u>	<u>Dept-Wide Priority</u>	<u>Description of Addition</u>	<u>Justification</u>	<u>MOF</u>	<u>Pos (P)</u>	<u>Pos (T)</u>	<u>\$\$\$</u>
EDN 200	RR	1	1	Sabbatical Leave - to meet the Department's obligation to provide sabbatical leaves per the HSTA contract.	The State of Hawaii and Hawaii State Teachers Association (HSTA) have reached a four year contractual agreement beginning with SY 2013-2014 through SY 2016-2017, in which the Department is obligated to provide sabbatical leave for teachers.	A			592,000
EDN 300	RR	1	1	Council of Chief State School Officers (CCSSO) - to cover the cost of annual membership in organization for the nation's chief state school officers leading state educational agencies.	CCSSO convenes members for professional development and peer networking throughout the year. In the past year, Hawaii has participated in at least seven state collaboration sessions, sponsored by CCSSO. Participation has impacted implementation of Hawaii's Common Core, development of the Smarter Balanced assessment system, supports for math educators, and policies and procedures for education information management.	A			36,000
EDN 300	RR	1	1	Communications and Community Affairs Office - to fund personnel (5.0 permanent positions) and operating expenses for the strategic needs of the Department's communication arm.	Funds for other current expenses are for contractual services to meet the needs of technological advances in communications, neighbor island travel to continue the path of sharing success stories, office equipment, and other operating expenses. This is a funding request only for permanent positions in the Communications and Community Affairs office, which supports the executive function of the Superintendent by developing the internal and external communication aspects of the public school system, with an emphasis on promoting the mission, goals and objectives set forth in the Strategic Plan.	A			431,037

Department of Education
Proposed Budget Additions

Table 6

<u>Prog ID</u>	<u>Request Category</u>	<u>Prog ID Priority</u>	<u>Dept-Wide Priority</u>	<u>Description of Addition</u>	<u>Justification</u>	<u>MOF</u>	<u>Pos (P)</u>	<u>Pos (T)</u>	<u>\$\$\$</u>
EDN 300	RR	1	1	Civil Rights Compliance Office - for (2.0) temporary FTEs to assist in meeting the most immediate needs of the Department with respect to compliance in the area of Title VI of the Civil Rights Act and federal audits.	The Civil Rights Compliance Office (CRCO) intakes approximately 275 cases for investigation, enforcement response, and ADA compliance per year. Currently, the caseload is being handled by only one (1) permanent, full-time specialist (Title IX specialist) dedicating part of the time to investigations and the other part of the time to compliance.	A		2.00	130,360
EDN 300	RR	1	1	Teacher Mentor Program - to provide research-based mentor training; beginning teacher, mentor, and induction leadership professional development; cross state professional development opportunities; consultation and support complex areas; training materials; office supplies; and travel.	Federal Title IIa dollars substantially support the induction and mentoring effort. This is the general fund contribution to ensure support for successful teachers. There is a shortage of trained and effective instructional mentors across the state; urgent need to build capacity and increase number of full-release mentors to support approximately 1,600 beginning teachers each year (over 2,500 veteran teachers are eligible for retirement over next 5 years).	A			256,000
EDN 300	RR	1	1	Alternative Teacher Route - to extend the current alternative route teaching contract to recruit and place teacher candidates.	Since 2011, the Department has partnered with Teach for America (TFA) to recruit and place teachers in high-needs schools and areas. This includes teachers for students with disabilities. Over the past two years, TFA has recruited and placed approximately 100 teachers into high-needs schools. One third are kama'aina returning back to Hawaii. Recent internal analysis shows that TFA teachers have among the highest student survey and growth scores of all in-state teacher prep programs.	A			870,000
EDN 300	O	1	1	Professional Development Management System (PDMS) - to maintain the subscription for the PDE3 technology platform, a secure, on-line, portal that connects educators with professional development opportunities tied to their education effectiveness data.	Funding is necessary to maintain the subscription for the PDE3 technology platform, a secure, on-line, professional development management system (PDMS) that provides personnel information and reporting tools to continuously improve workforce competencies necessary to impact student achievement.	A			599,208

Department of Education
Proposed Budget Additions

Table 6

<u>Prog ID</u>	<u>Request Category</u>	<u>Prog ID Priority</u>	<u>Dept-Wide Priority</u>	<u>Description of Addition</u>	<u>Justification</u>	<u>MOF</u>	<u>Pos (P)</u>	<u>Pos (T)</u>	<u>\$\$\$</u>
EDN 300	O	1	1	Electronic Human Resources (eHR) - to maintain technical production support for the existing system that is business critical to the Department.	The eHR system is used for the intake of applications, the hiring of employees, payroll processing, and an employee's eventual separation transaction, as well as many other functions unique to the Department.	A			300,000
EDN 300	RR	1	1	HR Executive Assistant - to fund position to improve HR support to the field through streamlined recruitment, onboarding and alignment initiatives.	Funding for the Human Resources (HR) Executive Assistant salary and equipment is needed to assist the Department's Office of Human Resources (OHR) Assistant Superintendent (AS) with critical support, to include day-to-day administration, direction, leadership and management of OHR; conducting research and executive analysis of data to respond to the Board of Education requests and concerns; serving as a coordinator and liaison with the Department's Office of Fiscal Services and Office of Information Technology Services; keeping abreast of programs, policy changes and administrative directives and ensuring that OHR activities are conducted as required.	A			100,503
EDN 300	RR	1	1	OITS positions - for 15.0 Permanent FTEs for the Office of Information Technology Services: 1.0 DPSA V for the Network Design Section; 3.0 DPSA IV positions to support school level technology integration; 7.0 IT Specialist III to improve the quality and responsiveness of information technology services and support to the schools, complex areas, and state administrative; 1.0 DPSA IV to fulfill the role of the Information Systems Training Unit (ISTU) Head; 1.0 DPSA VI for to Data Management Section to lead database development, administration, and maintenance; and 2.0 DPSA IV to provide programming/integration for educational technology systems and the development maintenance, administration, and management of all School systems.	Through the State Strategic Plan, the Department and Board of Education have committed to providing students with 21st century learning environments. The Department has identified IT strategies to replace aging school and state office systems (student information system, statewide enterprise resource planning). School level demand for technology, in addition to the IT strategies identified by the state, require project management support for successful deployment; however, the Department has a shortage of internal IT staff. The request for 15.0 FTE permanent positions for the Office of Information Technology Services is to support OITS transformation, reorganization, and 21st Century learning at schools.	A	15.00		

Department of Education
Proposed Budget Additions

Table 6

<u>Prog ID</u>	<u>Request Category</u>	<u>Prog ID Priority</u>	<u>Dept-Wide Priority</u>	<u>Description of Addition</u>	<u>Justification</u>	<u>MOF</u>	<u>Pos (P)</u>	<u>Pos (T)</u>	<u>\$\$\$</u>	
EDN 400	RR	1	1	Utilities - to account for the projected shortfall in the utility budget, which covers the cost of electricity, gas, water and sewer expenses.	The Auxiliary Services Branch pays all utility bills (electricity, gas, water, sewer) centrally for all Department of Education (DOE) schools and DOE owned facilities. For fiscal year 2014-2015, the utility appropriation is \$49.5 million.	A			9,000,000	
EDN 300	ND	1	1	Early Learning Coordinator - to fund position to support early childhood education policies, curriculum, and assessment relating to kindergarten and other pre-kindergarten programs.	Establishing a strong foundation of learning in early elementary grades is critical to build to students graduating prepared for success in life after high school.	A	1.00		70,000	
EDN 200	ND	1	1	Digital Curriculum Pilot - to contract technology support services and provide professional development for the digital pilot schools.	As of December 2013, all pilot schools were on track to complete their professional development and roll out student devices in January 2014. Three of eight pilot schools deployed student devices in the first semester – ahead of schedule. Servicing roughly 6,106 students (as of 12/24 LDS data) and 448 teachers. An overwhelming majority of teachers surveyed reported that the devices will be extremely effective and save them time on day to day tasks such as creating assignments (94%) and planning for instruction (93%).	A		3.00	600,000	
NEW FY 15 SUPPLEMENTAL BUDGET REQUEST										
TOTAL								16.00	27.00	31,719,818

Department of Education
 Current Year (FY14) Restrictions

Table 7

<u>Prog ID</u>	<u>MOF</u>	<u>Restriction \$\$\$</u>	<u>Percent of Act 134/13 Prog ID Appropriation</u>	<u>Impact</u>
None				

Department of Education
Emergency Appropriation Requests

Table 8

<u>Prog ID</u>	<u>Description of Request</u>	<u>Explanation of Request</u>	<u>MOE</u>	<u>Pos (P)</u>	<u>Pos (T)</u>	<u>\$\$\$</u>
None						

Department of Education
Expenditures Exceeding the Appropriation

Table 9

<u>Prog ID</u>	<u>MOF</u>	<u>Date</u>	<u>Appropriation</u>	<u>Amount Exceeding Appropriation</u>	<u>Percent Exceeded</u>	<u>Reason for Exceeding Ceiling</u>	<u>Legal Authority</u>	<u>Recurring (Y/N)</u>	<u>GF Impact (Y/N)</u>
EDN 400	N	6/13/2013	49,143,812	2,059,085	4%	Due to receipt of the federal awards for the USDA's Fresh Fruit and Vegetable Program, Team Nutrition Competitive Grant, and Meal Pattern Technical Assistance Program received after the 2012 Session.	Act 106, SLH 2012	N	N
EDN 300	N	8/26/2013	-	1,263,500	100%	Due to receipt of federal award for the Hawaii Statewide Longitudinal P-20 Data System after the 2013 Session.	Act 134, SLH 2013	Y	N
EDN 100	P	11/1/2013	17,678,689	64,283	0%	Due to receipt of federal award for a Youth Risk Behavior Survey received after the 2013 Session.	Act 134, SLH 2013	Y	N
EDN 100	P	12/18/2013	17,678,689	1,867,000	11%	Due to receipt of federal award for Compact Impact program after the 2013 Session.	Act 134, SLH 2013	N	N

Department of Education
Intradepartmental Transfers

Table 10

<u>Actual or Anticipated Date of Transfer</u>	<u>MOF</u>	<u>Pos (P)</u>	<u>Pos (T)</u>	<u>\$\$\$</u>	<u>From Prog ID</u>	<u>Percent of Program ID Appropriation Transferred From</u>	<u>To Prog ID</u>	<u>Percent of Receiving Program ID Appropriation</u>	<u>Reason for Transfer</u>	<u>Recurring (Y/N)</u>
8/30/2012	A	-	-	\$ 500,000	150	0%	500	20%	To meet projected shortfall due to initial quarterly allocation due to Community School for Adults transition to operating with reduced funding.	N
9/18/2012	N	-	-	\$ 869,840	150	2%	300	2485%	To transfer federal fund ceiling to partially accommodate the State Longitudinal Data System grant award.	N
10/31/2012	A	-	-	\$ 2,976,120	600	5%	100	0%	To equalize per pupil allocations between Charter and DOE schools per Hawaii Revised Statute §302D-28.	N
6/4/2013	N	-	-	\$ 828,769	150	1%	100	0%	To transfer federal fund ceiling to accommodate the FY13 Impact Aid grant award.	N
6/21/2013	A	-	-	\$ 425,000	500	17%	150	0%	To return funds not required by the Community School for Adults' projected shortfall from August 2012.	N
6/30/2013	A	-	-	\$ 700,000	200	2%	400	0%	To meet projected salary shortfall due to the FY13 Executive Restriction.	N
6/30/2013	A	-	-	\$ 11,000	200	0%	500	0%	To meet salary shortfall for Community School for Adults.	N
6/30/2013	A	-	-	\$ 800,000	300	2%	400	2%	To meet projected salary shortfall due to the FY13 Executive Restriction.	N
9/17/2013	A	-	-	\$ (6,379)	100	0%	700	5%	Transfer-out of a proportionate share of the FY14 Executive Restriction imposed on the DOE to the Executive Office on Early Learning	N
11/4/2013	A	-	-	\$ 698,018.50	600	1%	100	0%	To equalize per pupil allocations between Charter and DOE schools per Hawaii Revised Statute §302D-28.	N

Department of Education
Federal Awards

Table 11

<u>State Expending Agency</u>	<u>Program ID</u>	<u>Award Number</u>	<u>CFDA Number</u>	<u>Award Description</u>	<u>Awarding Federal Agency</u>	<u>Award Amount</u>	<u>Award Amount</u>	<u>Award Allocated to the Pgm ID in Column B</u>	<u>State Appropriation Symbol</u>	<u>Contact Name</u>	<u>Contact Phone</u>	<u>Contact Email</u>
E	EDN100	VARIOUS	84.041	FEDERAL IMPACT AID, P.L. 874*	DOE	\$ 80,614,955	\$ 80,614,955		210	Brian Hallett	586-3350	brian_hallett@notes.k12.hi.us
E	EDN100	S287C130011	84.287C	NCLB - AFTER SCHOOL LEARNING CENTER	DOE	\$ 5,348,665	\$ 5,348,665		210	Daniel Williams	203-5520	daniel_williams@notes.k12.hi.us
E	EDN100	S366B130012	84.366B	NCLB - MATHEMATICS & SCIENCE PARTNERSHIP	DOE	\$ 705,964	\$ 705,964		210	Dewey Gottlieb	203-5537	dewey_gottlieb@notes.k12.hi.us
E	EDN100	S144F130052	84.144F	NCLB - MIGRANT ED PROGRAM CONSORTIUM	DOE	\$ 120,000	\$ 120,000		210	Sol Kaulukukui	203-5520	solomon_kaulukukui@notes.k12.hi.us
E	EDN100	S011A130052	84.011A	NCLB - MIGRANT EDUCATION TITLE I	DOE	\$ 790,074	\$ 790,074		210	Sol Kaulukukui	203-5520	solomon_kaulukukui@notes.k12.hi.us
E	EDN100	S013A130011	84.013A	NCLB - NEGLECTED & DELINQUENT TITLE I	DOE	\$ 356,770	\$ 356,770		210	Sharon Nakagawa	203-5520	sharon_nakagawa@notes.k12.hi.us
E	EDN100	S369A130012	84.369A	NCLB - STATE ASSESS & RELATED ACTIVITIES	DOE	\$ 3,788,936	\$ 3,788,936		210	Cara Tanimura	586-3283	cara_tanimura@notes.k12.hi.us
E	EDN100	S010A130011	84.010A	NCLB - TITLE I GRANTS TO LEA ADMIN	DOE	\$ 589,751	\$ 589,751		210	Sharon Nakagawa	203-5520	sharon_nakagawa@notes.k12.hi.us
E	EDN100	S010A130011	84.010A	NCLB - TITLE I GRANTS TO LEAS BASIC-CON	DOE	\$ 45,104,194	\$ 45,104,194		210	Sharon Nakagawa	203-5520	sharon_nakagawa@notes.k12.hi.us
E	EDN100	S010A130011	84.010A	NCLB - TITLE I SCHOOL IMPROVEMENT GRANT	DOE	\$ 1,903,914	\$ 1,903,914		210	Sharon Nakagawa	203-5520	sharon_nakagawa@notes.k12.hi.us
E	EDN100	S367A130010	84.367A	NCLB - TITLE II IMPROVING TCHR QUALITY	DOE	\$ 10,582,856	\$ 10,582,856		210	Carol Tenn	586-4077	carol_tenn@notes.k12.hi.us
E	EDN100	V048A130011	84.048A	VOC ED-BASIC GRANT TO STATES	DOE	\$ 2,439,938	\$ 2,439,938		210	Sherilyn Lau	203-5533	sherilyn_lau@notes.k12.hi.us
E	EDN100	D13AF00047	15.875	DEPARTMENT OF INTERIOR - COMPACT IMPACT	DOI	\$ 1,867,000	\$ 1,867,000		810	Brian Hallett	586-3350	brian_hallett@notes.k12.hi.us
E	EDN100	809935513	12.558	DEPT OF DEFENSE FINANCIAL ASSIST LEA'S	DOD	\$ 3,410,131	\$ 3,410,131		810	Brian Hallett	586-3350	brian_hallett@notes.k12.hi.us
E	EDN100	809935513	93.938	NATIONAL CENTER FOR CHRONIC DISEASE PREV	DHHS	\$ 64,283	\$ 64,283		810	Ann Horiuchi	203-5538	ann_horiuchi@notes.k12.hi.us
E	EDN100	S330B130001	84.330B	TEST FEE PROGRAM - APF	DOE	\$ 99,330	\$ 99,330		810	Anna Viggiano	203-5505	anna_viggiano@notes.k12.hi.us
E	EDN100	V048A120011	84.048A	VOC ED-NON TRADITIONAL-STEM FY14	DOE	\$ 12,900	\$ 12,900		810	Sherilyn Lau	203-5533	sherilyn_lau@notes.k12.hi.us
E	EDN150	H027A130132	84.027A	ED OF THE HANDI CHILD, TITLE VI-B	DOE	\$ 476,000	\$ 476,000		215	Debra Farmer	203-5560	debra_farmer@notes.k12.hi.us
E	EDN150	H173A130083	84.173A	PART B - PRESCHOOL GRANTS IDEA	DOE	\$ 903,029	\$ 903,029		215	Anne Kokubun	203-5560	anne_kokubun@notes.k12.hi.us
E	EDN150	H027A130132	84.027A	STATE GRANTS-SPED GRANTS TO STATE IDEA	DOE	\$ 37,231,882	\$ 37,231,882		215	Debra Farmer	203-5560	debra_farmer@notes.k12.hi.us
E	EDN200	S196A130012	84.196A	ED FOR HOMELESS CHILDREN & YOUTH	DOE	\$ 230,069	\$ 230,069		220	Sharon Nakagawa	203-5520	sharon_nakagawa@notes.k12.hi.us
E	EDN300	R372A120004-13	84.372	STATEWIDE LONGITUDINAL DATA SYSTEMS	DOE	\$ 1,263,500	\$ 1,263,500		230	Christina Tydeman	369-8140	christina_tydeman@notes.k12.hi.us
E	EDN400	7HI300HI2	10.560	HCNP - STATE ADMIN EXPENSE	USDA	\$ 236,078	\$ 236,078		240	Sue Uyehara	587-3600	sue_uyehara@notes.k12.hi.us
E	EDN400	7HI300HI3	10.555	SFS - NATIONAL SCHOOL LUNCH PROGRAM*	USDA	\$ 64,379,361	\$ 64,379,361		240	Glenna Owens	733-8400	glenna_owens@notes.k12.hi.us
E	EDN400	7HI300HI3	10.555	HCNP - CACFP AUDIT	USDA	\$ 94,853	\$ 94,853		241	Sue Uyehara	587-3600	sue_uyehara@notes.k12.hi.us
E	EDN400	7HI310HI1	10.582	HCNP - FF&V ADMIN	USDA	\$ 75,799	\$ 75,799		241	Sue Uyehara	587-3600	sue_uyehara@notes.k12.hi.us
E	EDN500	V002A130011	84.002A	ADULT EDUCATION - STATE ADMINISTERED	DOE	\$ 2,088,609	\$ 2,088,609		250	Deborah Miyao	203-5505	deborah_miyao@notes.k12.hi.us

* as reimbursement programs, the FY14 award amount reflects FY13 receipts

Department of Education
Non-General Fund Listing

Table 12

<u>Name of Fund</u>	<u>Purpose</u>	<u>Statutory Reference</u>	<u>MOF</u>	<u>Beginning FY14 Unencumbered Cash Balance</u>	<u>Estimated FY14 Revenues</u>	<u>Estimated FY14 Expenditures and Encumbrances</u>	<u>Estimated FY14 Net Transfers</u>	<u>Estimated FY14 Ending Unencumbered Cash Balance</u>	<u>Balance in Excess of Program Needs</u>
Adult Education Revolving Fund	This fund was established in 1970 to receive fees assessed for Adult Education courses.	HRS §302A-435	W	\$ 453,346	\$ 150,000	\$ 270,000	\$ -	\$ 333,346	\$ -
Adult Education Special Fund	This fund was established in 1945 to collect tuition for special interest classes and fees for the General Education Development (GED) test in the Adult Education Program.	HRS §302A-435	B	\$ 501,922	\$ 400,000	\$ 550,000	\$ -	\$ 351,922	\$ -
After-School Plus Program Revolving Fund	The fund was established in 2004 to deposit fees collected to support the after-school program.	HRS §302A-1149.5	W	\$ 2,857,318	\$ 9,500,000	\$ 9,400,000	\$ -	\$ 2,957,318	\$ -
Alu Like Projects	This fund was established in 1992 to account for moneys received through a memorandum of agreement with Alu Like, Inc.'s Native Hawaiian Vocational Education Program.	HRS §302A-1122	T	143,598	225,000	\$ 235,000	\$ -	\$ 133,598	\$ -
Arts in Public Places	This fund was established to deposit funds received from the Works of Art Special Fund to implement an integrated visual arts in education program.	HRS §302A-420	U	5,599	90,000	\$ 95,000	\$ -	\$ 599	\$ -
Athletic Trust Fund	This fund was established 30 years ago to account for funds collected from athletic event-related activities.	HRS §302A-1122	T	1,352,141	1,000,000	\$ 1,200,000	\$ -	\$ 1,152,141	\$ -
Community Use of School Facilities	The fund was established in 1982 to collect fees and charges from those who use school buildings, facilities, grounds and equipment for recreational and community purposes.	HRS §302A-1148	B	3,860,095	2,400,000	\$ 2,500,000	\$ -	\$ 3,760,095	\$ -
Donations and Gifts	This fund was established in 1961 to account for donations made to schools for specific purposes.	HRS §302A-1122	T	7,673,767	1,350,000	\$ 1,750,000	\$ -	\$ 7,273,767	\$ -
Driver Education Fund	This fund was never created by statute, but was established in 1987 by the department to deposit fees collected by the insurance commissioner from motor vehicle insurers under Section 431:10C-115, HRS.	HRS §431:10C-115 and §431:10G-107	U	3,049,531	1,900,000	\$ 2,600,000	\$ -	\$ 2,349,531	\$ -
Education Design and Construction Project Assessment Fund	Pursuant to Act 51, SLH 2004 this fund was transferred from the Department of Accounting and General Services to the Department of Education effective July 1, 2005. The fund was established to defray the costs of carrying out construction projects.	HRS §302A-1508	W	1,356,771	1,000,000	\$ 1,650,000	\$ -	\$ 706,771	\$ -

Department of Education
Non-General Fund Listing

Table 12

<u>Name of Fund</u>	<u>Purpose</u>	<u>Statutory Reference</u>	<u>MOF</u>	<u>Beginning FY14 Unencumbered Cash Balance</u>	<u>Estimated FY14 Revenues</u>	<u>Estimated FY14 Expenditures and Encumbrances</u>	<u>Estimated FY14 Net Transfers</u>	<u>Estimated FY14 Ending Unencumbered Cash Balance</u>	<u>Balance in Excess of Program Needs</u>
Education Research and Development Revolving Fund	This fund was established in 2001 to deposit revenues from the commercial exploitation of products and services developed by the department.	HRS §302A-305	W	120,883	\$ -	120,883	\$ -	\$ -	\$ -
Federal Grants Search, Development, and Application Revolving Fund	This fund was established in FY2000-01 to deposit the recovery of administrative or central service costs incurred to carry out federal grant awards through an indirect cost assessment authorized by the federal government.	HRS §302A-1405	W	2,839,158	500,000	\$ 1,045,000	\$ -	\$ 2,294,158	\$ -
Federal Maximization Revolving Fund	The fund was established to enhance the health and welfare of Hawaii's public school children by creating a revolving fund for the collection and disbursement of generated revenue to support the administration and operations of the Department of Education revenue maximization program.	HRS §302A-1406	W	\$ 1,267,364	\$ 1,200,000	\$ 1,500,000	\$ -	\$ 967,364	\$ -
Foundation and Other Grants	This fund was established in 1961 to account for grants received from foundations, other non-profit organizations, and other state agencies for various projects.	HRS §302A-1122	T	11,442,605	3,000,000	\$ 6,300,000	\$ -	\$ 8,142,605	\$ -
Hawaii School-Level Minor R&M Special Fund	This fund was established in 2001 to deposit funds received for school-level minor repairs and maintenance.	HRS §302A-1504.5	B	91,568	75,000	150,000	\$ -	\$ 16,568	\$ -
Hawaii Teachers Standards Board	This fund was created in 1998 to support the Hawaii Teachers Standard Board. The board establishes standards governing teacher licensing and credentialing within the department, conducts cyclical review of standards, and suggests revisions for their improvement.	HRS §302A-806	B	3,054,748	700,000	1,400,000	\$ -	\$ 2,354,748	\$ -
Comprehensive Student Support Services Human Resources Stipend Prog Spec Fund	This fund was established to create a special fund into which shall be deposited moneys received as repayment from students who have breached their contractual agreements under the Felix stipend program.	HRS §302A-707	B	239,713	80,000	\$ 200,000	\$ -	\$ 119,713	\$ -
Office of Hawaiian Affairs	This fund was established in 1991 to account for grants received from the Office of Hawaiian Affairs (OHA) for tutorial and other educational projects at various schools.	HRS §302A-1122	T	529,364	0	\$ 64,000	\$ -	\$ 465,364	\$ -

Department of Education
Non-General Fund Listing

Table 12

<u>Name of Fund</u>	<u>Purpose</u>	<u>Statutory Reference</u>	<u>MOF</u>	<u>Beginning FY14 Unencumbered Cash Balance</u>	<u>Estimated FY14 Revenues</u>	<u>Estimated FY14 Expenditures and Encumbrances</u>	<u>Estimated FY14 Net Transfers</u>	<u>Estimated FY14 Ending Unencumbered Cash Balance</u>	<u>Balance in Excess of Program Needs</u>
OLELO - Educational Program Public TV	This fund was established in 1992 to account for funds received under contract with Olelo: The Corporation for Community Television.	HRS §302A-1122	T	848,332	600,000	\$ 825,000	\$ -	\$ 623,332	\$ -
Regular Instruction - High School (Lahainaluna Boarding Dept-Special Fund)	The fund was established in 1921 to hold revenues collected by the Lahainaluna Boarding School and to finance its vocational program.	HRS §302A-420	B	26,574	4,000	\$ 9,000	\$ -	\$ 21,574	\$ -
School Bus Fare Revolving Fund	This fund was created in FY2002-03 to deposit school bus fares collected from students, parents, or guardians for state-provided school busing services.	HRS §302A-407.5	W	4,835,055	2,600,000	\$ 3,100,000	\$ -	\$ 4,335,055	\$ -
School Community Services (A+ Interdepartmental Transfer-DHS)	This fund was established to deposit funds received from the Department of Human Services (DHS) for the department's after-school care program.	HRS §302A-408	U	2,079,258	0	1,000,000	\$ -	\$ 1,079,258	\$ -
School Food Service	Created in 1960, this fund supports the expense of operating public school cafeterias.	HRS §302A-405	B	1,956,306	26,000,000	\$ 26,500,000	\$ -	\$ 1,456,306	\$ -
School Special Fee (Reimbursement for Lost Textbook and Equipment)	This fund was established to deposit fees collected to replace damaged or lost books and supplies.	HRS §302A-1130.5-6	B	1,318,742	200,000	\$ 460,000	\$ -	\$ 1,058,742	\$ -
Summer School and Intersession Fund	The summer school fund was originally established in 1971 to finance summer school programs. Amended in 1996, the fund currently serves intersession programs for year-round school in addition to summer school programs.	HRS §302A-1310	B	1,822,765	2,200,000	\$ 3,700,000	\$ -	\$ 322,765	\$ -
Teacher Housing	The fund was established to fund the activities of the Department of Education's Teacher Housing Program.	HRS §302A-833	W	341,070	320,000	\$ 395,000	\$ -	\$ 266,070	\$ -

Department of Education
Vacancy Summary

Table 13

Prog ID	MOF	All Established Positions*					Salaries and Wages		
		Total Permanent FTE	Total Vacant Permanent FTE	Total Temporary FTE	Total Vacant Temporary FTE	% Vacant	Budgeted Amount for All Positions	Budgeted Amount for All Filled Positions	Approximate Vacancy Savings Rate
EDN100	A	12,561.350	8.50	678.300	4.00	0.1%	661,459,109	\$ 661,016,891	0.1%
EDN150	A	5,173.625	74.75	1,229.250	85.25	2.5%	265,824,847	\$ 261,548,909	1.6%
EDN200	A	377.000	15.00	59.000	1.00	3.7%	23,806,417	\$ 22,849,655	4.0%
EDN300	A	446.500	32.00	10.000	1.00	7.2%	23,163,750	\$ 21,473,854	7.3%
EDN400	A	637.000	28.50	3.000	1.00	4.6%	23,917,220	\$ 22,922,441	4.2%
EDN500	A	29.000		5.000		0.0%	1,981,042	\$ 1,981,042	0.0%
						-			-
						-			-
* General funded position information as of November 30, 2013.						-			-
						-			-
						-			-
						-			-
						-			-
						-			-
						-			-
						-			-
						-			-
						-			-
						-			-
						-			-
						-			-
						-			-
						-			-
						-			-
						-			-
						-			-
						-			-
						-			-
						-			-
						-			-
						-			-
						-			-
						-			-

Department of Education
Vacant Positions as of November 30, 2013

Table 14

Prog ID	Date of Vacancy	Expected Fill Date	Position Number*	Position Title	Exempt (Y/N)	SR Level	BU Code	Perm Temp (P/T)	FTE	MOF	Budgeted Amount	Actual Salary Last Paid	Authority to Hire (Y/N)	Occupied by 89 Day Hire (Y/N)	# of 89 Hire Appts	Describe if Filled by other Means	Priority # to Retain**
EDN150	10/1/2013		803053	Educ Asst III	Y	SR12	03	T	1.000	A	\$ 25,030	\$ 25,667	Y	Y	2		
EDN100	8/30/2013		800531	Athletic Hlth Care Trainer	Y	SR22	13	P	1.000	A	\$ 42,073	\$ 47,403	Y	N			
EDN400	5/14/2012		2022	School Food Services Mgr II	N	F106	02	P	1.000	A	\$ 34,821	\$ 43,722	Y	N			
EDN400	3/8/2013		26885	Cafeteria Helper	N	BC02	01	P	0.500	A	\$ 13,232	\$ 16,614	Y	N			
EDN400	8/19/2013		37392	School Custodian II	N	BC02	01	P	0.500	A	\$ 14,922	\$ 16,942	Y	Y	2		
EDN150	7/1/2013		802822	Educ Asst III	Y	SR12	03	P	0.750	A	\$ 18,773	\$ -	Y	N			
EDN150	7/1/2013		802823	Educ Asst III	Y	SR12	03	P	0.750	A	\$ 18,773	\$ -	Y	N			
EDN150	1/2/2013		37044	Educ Asst III	Y	SR12	03	P	0.875	A	\$ 28,121	\$ 30,054	Y	N			
EDN150	12/16/2011		57557	Educ Asst III	Y	SR12	03	T	0.875	A	\$ 21,394	\$ 21,129	Y	N			
EDN150	12/29/2012		29642	Educ Asst III	Y	SR12	03	P	0.750	A	\$ 26,060	\$ 27,851	Y	N			
EDN150	6/30/2012		57417	Educ Asst III	Y	SR12	03	T	0.750	A	\$ 21,408	\$ 22,879	Y	N			
EDN150	11/1/2013		55447	Educ Asst III	Y	SR12	03	P	0.750	A	\$ 21,407	\$ 23,827	Y	N			
EDN150	7/1/2005		57600	Educ Asst III	Y	SR12	03	T	0.500	A	\$ 12,226	\$ 9,547	Y	N			
EDN150	7/1/2013		802876	Educ Asst III	Y	SR12	03	T	0.500	A	\$ 12,515	\$ -	Y	N			
EDN150	7/1/2013		803033	Educ Asst III	Y	SR12	03	T	0.750	A	\$ 18,773	\$ -	Y	N			
EDN150	7/1/2006		53189	Educ Asst III	Y	SR12	03	T	0.750	A	\$ 18,338	\$ 15,865	Y	N			
EDN150	7/30/2013		55429	Educ Asst III	Y	SR12	03	P	0.500	A	\$ 12,226	\$ 12,074	Y	N			
EDN150	10/13/2011		802400	Educ Asst III	Y	SR12	03	T	0.750	A	\$ 18,338	\$ -	Y	N			
EDN150	7/24/2013		57584	Educ Asst III	Y	SR12	03	T	0.875	A	\$ 21,394	\$ 23,760	Y	N			
EDN150	11/18/2013		803032	Educ Asst III	Y	SR12	03	T	0.750	A	\$ 18,773	\$ 19,599	Y	N			
EDN150	6/27/2009		57434	Educ Asst III	Y	SR12	03	P	0.750	A	\$ 18,338	\$ 19,250	Y	N			
EDN150	8/16/2007		57830	Educ Asst III	Y	SR12	03	T	0.750	A	\$ 18,338	\$ 18,095	Y	N			
EDN150	8/5/2013		800166	Educ Asst III	Y	SR12	03	T	0.875	A	\$ 21,394	\$ 23,760	Y	N			
EDN150	5/1/2013		53137	Educ Asst III	Y	SR12	03	T	0.500	A	\$ 12,226	\$ 12,074	Y	N			
EDN150	10/5/2013		10883	Educ Asst III	Y	SR12	03	P	1.000	A	\$ 25,407	\$ 27,154	Y	N			
EDN150	7/31/2013		55071	Educ Asst III	Y	SR12	03	T	0.750	A	\$ 18,338	\$ 18,815	Y	N			
EDN150	5/1/2013		53166	Educ Asst III	Y	SR12	03	P	0.500	A	\$ 14,272	\$ 15,253	Y	N			
EDN150	7/1/2005		37665	Educ Asst III	Y	SR12	03	T	0.750	A	\$ 18,338	\$ 15,335	Y	N			
EDN150	7/27/2011		57430	Educ Asst III	Y	SR12	03	P	0.750	A	\$ 18,338	\$ 22,879	Y	N			
EDN150	7/31/2013		54846	Educ Asst III	Y	SR12	03	P	0.750	A	\$ 18,338	\$ 17,422	Y	N			
EDN150	7/1/2009		41335	Educ Asst III	Y	SR12	03	T	0.750	A	\$ 18,338	\$ 18,815	Y	N			
EDN150	7/1/2005		57617	Educ Asst III	Y	SR12	03	T	0.875	A	\$ 21,395	\$ 16,059	Y	N			
EDN150	2/11/2013		57541	Educ Asst III	Y	SR12	03	T	0.750	A	\$ 18,338	\$ 19,599	Y	N			
EDN150	6/30/2012		57624	Educ Asst III	Y	SR12	03	T	0.875	A	\$ 24,975	\$ 26,692	Y	N			
EDN150	5/1/2013		57577	Educ Asst III	Y	SR12	03	T	0.750	A	\$ 18,338	\$ 16,748	Y	N			
EDN150	5/25/2012		57423	Educ Asst III	Y	SR12	03	T	0.750	A	\$ 18,338	\$ 18,111	Y	N			
EDN150	6/30/2012		57625	Educ Asst III	Y	SR12	03	T	0.750	A	\$ 19,796	\$ 21,157	Y	N			
EDN150	10/29/2011		57979	Educ Asst III	Y	SR12	03	T	0.750	A	\$ 18,338	\$ 18,111	Y	N			
EDN150	8/15/2008		57431	Educ Asst III	Y	SR12	03	P	0.500	A	\$ 12,226	\$ 13,066	Y	N			
EDN150	11/7/2011		57626	Educ Asst III	Y	SR12	03	T	0.750	A	\$ 18,338	\$ 22,879	Y	N			
EDN150	7/16/2013		800152	Educ Asst III	Y	SR12	03	T	0.750	A	\$ 18,338	\$ 20,366	Y	N			
EDN150	7/1/2005		57592	Educ Asst III	Y	SR12	03	P	0.625	A	\$ 15,282	\$ 12,404	Y	N			
EDN150	6/30/2012		57628	Educ Asst III	Y	SR12	03	T	0.875	A	\$ 24,975	\$ 26,692	Y	N			
EDN150	10/23/2012		802832	Educ Asst III	Y	SR12	03	T	0.750	A	\$ 18,773	\$ -	Y	N			
EDN150	7/1/2005		57596	Educ Asst III	Y	SR12	03	P	1.000	A	\$ 24,452	\$ 19,095	Y	N			
EDN150	6/30/2012		57629	Educ Asst III	Y	SR12	03	T	0.750	A	\$ 21,407	\$ 22,879	Y	N			
EDN150	8/3/2013		57604	Educ Asst III	Y	SR12	03	P	0.750	A	\$ 18,338	\$ 18,815	Y	N			
EDN150	7/1/2005		800173	Educ Asst III	Y	SR12	03	T	0.750	A	\$ 18,338	\$ -	Y	N			

Department of Education
Vacant Positions as of November 30, 2013

Table 14

Prog ID	Date of Vacancy	Expected Fill Date	Position Number*	Position Title	Exempt (Y/N)	SR Level	BU Code	Perm Temp (P/T)	FTE	MOF	Budgeted Amount	Actual Salary Last Paid	Authority to Hire (Y/N)	Occupied by 89 Day Hire (Y/N)	# of 89 Hire Appts	Describe if Filled by other Means	Priority # to Retain**
EDN150	10/31/2008		800171	Educ Asst III	Y	SR12	03	T	0.750	A	\$ 18,338	\$ 19,250	Y	N			
EDN150	5/26/2012		801295	Educ Asst III	Y	SR12	03	T	0.750	A	\$ 18,338	\$ 19,599	Y	N			
EDN150	5/28/2010		801407	Educ Asst III	Y	SR12	03	T	0.750	A	\$ 18,339	\$ 16,748	Y	N			
EDN150	11/8/2012		802859	Educ Asst III	Y	SR12	03	T	0.750	A	\$ 18,773	\$ -	Y	N			
EDN150	8/11/2012		802363	Educ Asst III	Y	SR12	03	P	0.750	A	\$ 18,339	\$ 19,599	Y	N			
EDN150	7/1/2013		802870	Educ Asst III	Y	SR12	03	P	0.750	A	\$ 18,773	\$ -	Y	N			
EDN150	7/25/2012		12065	Social Worker IV	N	SR22	13	P	1.000	A	\$ 43,235	\$ 47,403	Y	Y	1		
EDN150	3/31/2012		50765	Human Svcs Prof IV	N	SR22	13	P	1.000	A	\$ 52,649	\$ 56,994	Y	N			
EDN150	6/1/2013		54420	Social Worker IV	N	SR22	13	P	1.000	A	\$ 54,744	\$ 59,261	Y	N			
EDN400	7/1/2011		47901	School Food Services Mgr III	N	F206	02	P	1.000	A	\$ 37,068	\$ 49,982	Y	N			
EDN150	12/1/2012		50324	Educ Asst III	Y	SR12	03	T	1.000	A	\$ 29,726	\$ 31,769	Y	N			
EDN100	7/30/2013		601386	Dist Off Tchr	Certificated	T02	05	T	1.000	A	\$ 32,713	\$ -	Y	N			
EDN150	9/27/2011		802342	Educ Asst III	Y	SR12	03	T	1.000	A	\$ 24,450	\$ -	Y	N			
EDN150	7/1/2013		802868	Educ Asst III	Y	SR12	03	T	1.000	A	\$ 25,030	\$ -	Y	N			
EDN150	7/1/2013		802869	Educ Asst III	Y	SR12	03	T	1.000	A	\$ 25,030	\$ -	Y	N			
EDN150	7/24/2012		50751	Human Svcs Prof IV	N	SR22	13	P	0.500	A	\$ 22,488	\$ 24,344	Y	N			
EDN150	11/1/2012		56231	Social Worker IV	N	SR22	13	P	0.500	A	\$ 24,337	\$ 26,347	Y	N			
EDN150	10/19/2012		24889	Educ Asst III	Y	SR12	03	P	1.000	A	\$ 24,450	\$ 25,667	Y	Y	2		
EDN150	11/8/2012		56746	Educ Asst III	Y	SR12	03	P	0.750	A	\$ 18,338	\$ 19,250	Y	Y	2		
EDN150	5/29/2013		57249	Educ Asst III	Y	SR12	03	P	1.000	A	\$ 29,726	\$ 25,667	Y	Y	2		
EDN200	8/31/2013		58050	Office Assistant III	N	SR08	03	P	1.000	A	\$ 29,453	\$ 25,667	Y	Y	1		
EDN200	9/1/2012		58098	Office Assistant III	N	SR08	03	P	1.000	A	\$ 31,851	\$ 25,667	Y	Y	2		
EDN150	7/31/2013		58924	Educ Asst III	Y	SR12	03	P	0.750	A	\$ 18,338	\$ 19,250	Y	Y	2		
EDN150	8/15/2013		801359	Educ Asst III	Y	SR12	03	P	1.000	A	\$ 24,450	\$ 25,667	Y	Y	2		
EDN400	6/1/2013		9347	Cafeteria Helper	N	BC02	01	P	1.000	A	\$ 26,463	\$ 33,228	Y	N			
EDN150	7/31/2013		51220	Educ Asst III	Y	SR12	03	P	0.500	A	\$ 12,226	\$ 12,544	Y	N			
EDN150	2/4/2013		57220	Educ Asst III	Y	SR12	03	P	0.750	A	\$ 18,338	\$ 19,599	Y	N			
EDN150	8/1/2013		58055	Educ Asst III	Y	SR12	03	P	0.500	A	\$ 12,226	\$ 12,544	Y	N			
EDN150	6/29/2013		58075	Educ Asst III	Y	SR12	03	P	0.750	A	\$ 20,609	\$ 22,026	Y	N			
EDN150	11/1/2013		800122	Educ Asst III	Y	SR12	03	P	0.750	A	\$ 21,407	\$ 23,827	Y	N			
EDN150	11/20/2012		800963	Educ Asst III	Y	SR12	03	P	0.500	A	\$ 12,226	\$ 13,066	Y	N			
EDN150	11/1/2013		57195	Educ Asst III	Y	SR12	03	T	0.750	A	\$ 18,338	\$ 20,366	Y	N			
EDN150	10/28/2013		58068	Educ Asst III	Y	SR12	03	T	0.750	A	\$ 18,338	\$ 18,111	Y	N			
EDN200	10/1/2013		75412	District Educ Spec II	Certificated	3E07	06	P	1.000	A	\$ 99,101	\$ 109,099	Y	N			
EDN400	8/1/2013		10317	School Food Services Mgr II	N	F106	02	P	1.000	A	\$ 40,925	\$ 53,445	Y	N			
EDN150	7/30/2013		58123	Educ Asst III	Y	SR12	03	P	1.000	A	\$ 24,450	\$ 27,154	Y	N			
EDN150	2/21/2013		52603	Educ Asst III	Y	SR12	03	P	1.000	A	\$ 24,095	\$ 27,058	Y	N			
EDN150	9/28/2012		57889	Educ Asst III	Y	SR12	03	P	1.000	A	\$ 24,095	\$ 27,058	Y	N			
EDN150	6/29/2013		800648	Educ Asst III	Y	SR12	03	P	1.000	A	\$ 24,095	\$ 27,058	Y	N			
EDN150	8/29/2013		56687	Educ Asst III	Y	SR12	03	P	0.750	A	\$ 18,338	\$ 19,250	Y	Y	2		
EDN150	8/3/2013		57335	Educ Asst III	Y	SR12	03	P	0.750	A	\$ 20,609	\$ 20,366	Y	N			
EDN150	2/16/2013		57348	Educ Asst III	Y	SR12	03	P	0.750	A	\$ 19,056	\$ 20,366	Y	N			
EDN150	10/31/2013		54989	Educ Asst III	Y	SR12	03	P	0.750	A	\$ 18,338	\$ 19,250	Y	N			
EDN400	10/1/2010		47344	Cafeteria Helper	N	BC02	01	P	0.500	A	\$ 16,614	\$ 16,614	Y	N			
EDN150	1/3/2012		56131	Educ Asst III	Y	SR12	03	P	0.500	A	\$ 12,226	\$ 13,066	Y	N			
EDN150	10/16/2013		54721	Educ Asst III	Y	SR12	03	P	0.500	A	\$ 12,226	\$ 13,577	Y	N			
EDN150	7/25/2012		52977	Educ Asst III	Y	SR12	03	P	0.500	A	\$ 14,863	\$ 15,885	Y	N			
EDN150	7/28/2010		800603	Educ Asst III	Y	SR12	03	T	1.000	A	\$ 24,450	\$ 27,154	Y	N			

Department of Education
Vacant Positions as of November 30, 2013

Table 14

Prog ID	Date of Vacancy	Expected Fill Date	Position Number*	Position Title	Exempt (Y/N)	SR Level	BU Code	Perm Temp (P/T)	FTE	MOF	Budgeted Amount	Actual Salary Last Paid	Authority to Hire (Y/N)	Occupied by 89 Day Hire (Y/N)	# of 89 Hire Appts	Describe if Filled by other Means	Priority # to Retain**
EDN150	7/30/2011		58888	Educ Asst III	Y	SR12	03	T	1.000	A	\$ 24,450	\$ 30,506	Y	N			
EDN150	10/29/2005		57327	Educ Asst III	Y	SR12	03	T	0.750	A	\$ 18,338	\$ 15,865	Y	N			
EDN150	7/24/2012		800043	Educ Asst III	Y	SR12	03	T	0.750	A	\$ 18,338	\$ 19,599	Y	N			
EDN150	3/6/2012		800044	Educ Asst III	Y	SR12	03	T	0.750	A	\$ 18,338	\$ 18,111	Y	N			
EDN150	10/26/2013		57030	Educ Asst III	Y	SR12	03	T	0.750	A	\$ 18,338	\$ 19,250	Y	N			
EDN150	9/26/2013		57369	Educ Asst III	Y	SR12	03	T	0.750	A	\$ 18,338	\$ 20,366	Y	N			
EDN150	12/3/2012		57924	Educ Asst III	Y	SR12	03	T	0.750	A	\$ 18,338	\$ 19,599	Y	N			
EDN100	6/29/2013		52471	Athletic Hlth Care Trainer	Y	SR22	13	P	1.000	A	\$ 42,073	\$ 45,573	Y	N			
EDN400	12/31/2011		2044	School Food Services Mgr I	N	WF06	02	P	1.000	A	\$ 32,691	\$ 41,048	Y	N			
EDN400	11/1/2013		9263	Cafeteria Helper	N	BC02	01	P	0.500	A	\$ 13,232	\$ 16,944	Y	N			
EDN150	10/19/2013		57421	Educ Asst III	Y	SR12	03	T	0.750	A	\$ 19,056	\$ 19,599	Y	N			
EDN150	4/16/2013		53164	Educ Asst III	Y	SR12	03	P	0.500	A	\$ 14,272	\$ 15,253	Y	N			
EDN150	11/15/2013		57608	Educ Asst III	Y	SR12	03	P	0.750	A	\$ 19,796	\$ 21,157	Y	N			
EDN150	5/31/2013		33259	Educ Asst III	Y	SR12	03	P	0.750	A	\$ 21,408	\$ 22,879	Y	N			
EDN150	9/4/2013		53123	Educ Asst III	Y	SR12	03	T	0.750	A	\$ 18,338	\$ 18,815	Y	N			
EDN150	7/1/2006		54594	Educ Asst III	Y	SR12	03	T	0.750	A	\$ 18,338	\$ 15,865	Y	N			
EDN150	12/1/2011		57017	Educ Asst III	Y	SR12	03	T	0.750	A	\$ 18,338	\$ 18,111	Y	N			
EDN150	6/27/2009		57551	Educ Asst III	Y	SR12	03	P	0.750	A	\$ 18,338	\$ 19,250	Y	N			
EDN150	3/9/2007		57552	Educ Asst III	Y	SR12	03	T	0.750	A	\$ 18,338	\$ 16,427	Y	N			
EDN150	11/1/2010		800161	Educ Asst III	Y	SR12	03	T	0.750	A	\$ 18,338	\$ 21,157	Y	N			
EDN150	10/13/2011		802399	Educ Asst III	Y	SR12	03	P	0.500	A	\$ 12,226	\$ -	Y	N			
EDN150	3/31/2007		57019	Educ Asst III	Y	SR12	03	T	0.750	A	\$ 18,338	\$ 16,427	Y	N			
EDN150	9/30/2006		800542	Educ Asst III	Y	SR12	03	P	0.750	A	\$ 18,338	\$ -	Y	N			
EDN150	5/28/2011		43885	Educ Asst III	Y	SR12	03	T	0.750	A	\$ 18,338	\$ 23,827	Y	N			
EDN150	6/30/2012		53167	Educ Asst III	Y	SR12	03	P	0.750	A	\$ 19,796	\$ 21,157	Y	N			
EDN150	1/16/2009		57018	Educ Asst III	Y	SR12	03	T	0.750	A	\$ 18,338	\$ 19,599	Y	N			
EDN150	6/30/2012		57410	Educ Asst III	Y	SR12	03	P	0.750	A	\$ 18,338	\$ 18,111	Y	N			
EDN150	6/30/2012		800153	Educ Asst III	Y	SR12	03	T	0.750	A	\$ 18,338	\$ 18,111	Y	N			
EDN150	8/28/2010		800540	Educ Asst III	Y	SR12	03	P	0.750	A	\$ 18,339	\$ 18,111	Y	N			
EDN200	6/9/2012		58052	Office Assistant III	N	SR08	03	P	1.000	A	\$ 28,352	\$ 31,212	Y	N			
EDN200	3/17/2012		58100	Office Assistant III	N	SR08	03	P	1.000	A	\$ 23,316	\$ 25,668	Y	N			
EDN100	8/24/2013		59997	Office Assistant III	N	SR08	03	T	1.000	A	\$ 23,666	\$ 25,667	Y	N			
EDN400	7/19/2012		10258	Cafeteria Helper	N	BC02	01	P	0.500	A	\$ 13,232	\$ 16,942	Y	Y	1		
EDN150	5/28/2011		39469	Educ Asst III	Y	SR12	03	P	0.750	A	\$ 18,338	\$ 19,250	Y	Y	6		
EDN150	7/17/2013		51912	Educ Asst III	Y	SR12	03	P	1.000	A	\$ 24,450	\$ 25,667	Y	Y	2		
EDN150	12/29/2012		50478	Social Worker IV	N	SR22	13	P	1.000	A	\$ 50,612	\$ 54,788	Y	N			
EDN150	7/11/2013		50768	Social Worker IV	N	SR22	13	P	1.000	A	\$ 43,235	\$ 47,403	Y	N			
EDN150	9/21/2013		55301	Educ Asst III	Y	SR12	03	P	0.500	A	\$ 12,226	\$ 13,577	Y	N			
EDN150	9/29/2012		801892	Educ Asst III	Y	SR12	03	P	0.500	A	\$ 12,226	\$ 12,834	Y	N			
EDN150	10/14/2013		802502	Educ Asst III	Y	SR12	03	P	0.500	A	\$ 12,515	\$ -	Y	N			
EDN150	10/14/2013		802503	Educ Asst III	Y	SR12	03	P	0.500	A	\$ 12,515	\$ -	Y	N			
EDN150	11/16/2012		802860	Educ Asst III	Y	SR12	03	P	0.750	A	\$ 18,773	\$ -	Y	N			
EDN100	10/15/2013		52463	Athletic Hlth Care Trainer	Y	SR22	13	P	1.000	A	\$ 42,073	\$ 47,400	Y	N			
EDN150	9/28/2013		57132	Educ Asst III	Y	SR12	03	T	0.500	A	\$ 12,226	\$ 12,834	Y	N			
EDN150	6/29/2013		57474	Educ Asst III	Y	SR12	03	T	0.500	A	\$ 12,226	\$ 13,066	Y	N			
EDN150	8/27/2011		57477	Educ Asst III	Y	SR12	03	T	0.500	A	\$ 12,226	\$ 12,834	Y	Y	10		
EDN150	10/1/2011		800555	Educ Asst III	Y	SR12	03	T	0.500	A	\$ 12,226	\$ 13,066	Y	N			
EDN150	5/28/2011		800571	Educ Asst III	Y	SR12	03	T	0.750	A	\$ 18,338	\$ 19,250	Y	Y	6		

Department of Education
Vacant Positions as of November 30, 2013

Table 14

Prog ID	Date of Vacancy	Expected Fill Date	Position Number*	Position Title	Exempt (Y/N)	SR Level	BU Code	Perm Temp (P/T)	FTE	MOF	Budgeted Amount	Actual Salary Last Paid	Authority to Hire (Y/N)	Occupied by 89 Day Hire (Y/N)	# of 89 Hire Appts	Describe if Filled by other Means	Priority # to Retain**
EDN150	7/31/2013		800578	Educ Asst III	Y	SR12	03	T	0.500	A	\$ 12,704	\$ 14,104	Y	N			
EDN150	7/31/2013		801891	Educ Asst III	Y	SR12	03	T	0.750	A	\$ 18,338	\$ 19,250	Y	Y	2		
EDN150	10/1/2013		801906	Educ Asst III	Y	SR12	03	T	0.500	A	\$ 12,226	\$ 12,834	Y	Y	6		
EDN150	7/31/2013		802611	Educ Asst III	Y	SR12	03	T	0.500	A	\$ 12,515	\$ -	Y	N			
EDN150	10/1/2013		802792	Educ Asst III	Y	SR12	03	T	0.750	A	\$ 18,773	\$ 19,250	Y	Y	3		
EDN150	10/1/2013		802793	Educ Asst III	Y	SR12	03	T	0.750	A	\$ 18,773	\$ 19,250	Y	Y	5		
EDN150	10/1/2013		802794	Educ Asst III	Y	SR12	03	T	0.500	A	\$ 12,515	\$ 12,834	Y	Y	3		
EDN150	10/2/2012		802803	Educ Asst III	Y	SR12	03	T	0.500	A	\$ 12,515	\$ -	Y	N			
EDN150	10/19/2012		802856	Educ Asst III	Y	SR12	03	T	0.500	A	\$ 12,515	\$ -	Y	N			
EDN150	8/1/2013		29763	Educ Asst III	Y	SR12	03	P	1.000	A	\$ 32,138	\$ 25,667	Y	Y	2		
EDN150	6/29/2013		50342	Educ Asst III	Y	SR12	03	T	1.000	A	\$ 26,395	\$ 25,667	Y	Y	2		
EDN150	3/1/2013		52627	Educ Asst III	Y	SR12	03	P	0.750	A	\$ 22,294	\$ 19,250	Y	Y	6		
EDN150	6/30/2012		55305	Educ Asst III	Y	SR12	03	P	1.000	A	\$ 24,451	\$ 25,667	Y	Y	1		
EDN150	6/30/2012		57508	Educ Asst III	Y	SR12	03	T	1.000	A	\$ 26,395	\$ 25,667	Y	Y	2		
EDN150	1/3/2013		58933	Educ Asst III	Y	SR12	03	P	1.000	A	\$ 24,451	\$ 25,667	Y	Y	2		
EDN150	11/27/2012		800085	Educ Asst III	Y	SR12	03	T	1.000	A	\$ 24,450	\$ 25,667	Y	Y	2		
EDN100	1/14/2011		800666	Office Assistant III	N	SR08	03	T	1.000	A	\$ 23,666	\$ 25,667	Y	Y	2		
EDN150	10/1/2013		802647	Educ Asst III	Y	SR12	03	P	0.500	A	\$ 12,515	\$ 12,834	Y	Y	2		
EDN150	10/1/2013		802945	Educ Asst III	Y	SR12	03	P	0.500	A	\$ 12,515	\$ 12,834	Y	Y	2		
EDN400	3/30/2013		48827	School Custodian II	N	BC02	01	P	0.500	A	\$ 14,922	\$ 16,614	Y	N			
EDN150	7/31/2013		50864	Educ Asst III	Y	SR12	03	P	0.750	A	\$ 21,407	\$ 23,827	Y	N			
EDN150	10/19/2013		57267	Educ Asst III	Y	SR12	03	P	1.000	A	\$ 26,395	\$ 29,368	Y	N			
EDN150	7/25/2012		801887	Educ Asst III	Y	SR12	03	T	1.000	A	\$ 24,450	\$ 26,131	Y	N			
EDN150	7/19/2013		802648	Educ Asst III	Y	SR12	03	P	1.000	A	\$ 25,030	\$ -	Y	N			
EDN150	10/2/2012		802804	Educ Asst III	Y	SR12	03	T	1.000	A	\$ 25,030	\$ -	Y	N			
EDN150	12/28/2012		802912	Educ Asst III	Y	SR12	03	T	1.000	A	\$ 25,030	\$ -	Y	N			
EDN150	6/29/2013		56771	Educ Asst III	Y	SR12	03	T	0.750	A	\$ 18,338	\$ 19,599	Y	N			
EDN150	8/4/2012		57287	Educ Asst III	Y	SR12	03	T	0.750	A	\$ 19,056	\$ 19,250	Y	Y	6		
EDN150	6/30/2012		57399	Educ Asst III	Y	SR12	03	T	0.750	A	\$ 21,407	\$ 19,250	Y	Y	5		
EDN150	5/29/2013		801896	Educ Asst III	Y	SR12	03	T	0.750	A	\$ 18,338	\$ 19,599	Y	N			
EDN150	5/25/2013		801901	Educ Asst III	Y	SR12	03	T	0.750	A	\$ 18,339	\$ 19,250	Y	N			
EDN150	10/16/2013		802587	Educ Asst III	Y	SR12	03	T	0.750	A	\$ 18,773	\$ 19,250	Y	Y	1		
EDN150	10/1/2013		802612	Educ Asst III	Y	SR12	03	T	0.750	A	\$ 18,773	\$ 19,250	Y	Y	2		
EDN150	7/31/2013		802613	Educ Asst III	Y	SR12	03	T	0.750	A	\$ 18,773	\$ -	Y	N			
EDN150	10/2/2012		802801	Educ Asst III	Y	SR12	03	T	0.500	A	\$ 12,515	\$ -	Y	N			
EDN400	7/16/2013		16982	Cafeteria Helper	N	BC02	01	P	0.500	A	\$ 16,614	\$ 16,942	Y	Y	2		
EDN150	7/24/2012		57221	Educ Asst III	Y	SR12	03	P	0.750	A	\$ 18,338	\$ 19,250	Y	Y	1		
EDN150	7/27/2011		52736	Educ Asst III	Y	SR12	03	P	1.000	A	\$ 24,450	\$ 31,769	Y	N			
EDN150	10/12/2013		57239	Educ Asst III	Y	SR12	03	T	1.000	A	\$ 25,407	\$ 28,209	Y	N			
EDN100	9/3/2013		802536	School Security Attendant	N	SR07	03	P	1.000	A	\$ 20,540	\$ -	Y	N			
EDN100	8/24/2013		48257	Athletic Hlth Care Trainer	Y	SR22	13	P	1.000	A	\$ 42,073	\$ 47,403	Y	Y	2		
EDN150	11/1/2013		57237	Educ Asst III	Y	SR12	03	T	0.750	A	\$ 18,338	\$ 20,366	Y	N			
EDN400	10/21/2013		NP8531	School Baker	N	BC06	01	P	1.000	A	\$ 38,436	\$ -	Y	N			
EDN400	10/21/2013		NP8532	School Baker	N	BC06	01	P	1.000	A	\$ 38,436	\$ -	Y	N			
EDN400	10/18/2013		NP8535	School Baker	N	BC06	01	P	1.000	A	\$ 38,436	\$ -	Y	N			
EDN400	10/1/2013		1954	School Food Services Mgr II	N	F106	02	P	1.000	A	\$ 38,453	\$ 50,217	Y	N			
EDN150	7/27/2011		55322	Educ Asst III	Y	SR12	03	P	1.000	A	\$ 24,450	\$ 25,667	Y	Y	5		
EDN150	6/1/2013		30042	Educ Asst III	Y	SR12	03	P	1.000	A	\$ 33,408	\$ 35,705	Y	N			

Department of Education
Vacant Positions as of November 30, 2013

Table 14

Prog ID	Date of Vacancy	Expected Fill Date	Position Number*	Position Title	Exempt (Y/N)	SR Level	BU Code	Perm Temp (P/T)	FTE	MOF	Budgeted Amount	Actual Salary Last Paid	Authority to Hire (Y/N)	Occupied by 89 Day Hire (Y/N)	# of 89 Hire Appts	Describe if Filled by other Means	Priority # to Retain**
EDN150	11/30/2013		54727	Educ Asst III	Y	SR12	03	P	1.000	A	\$ 28,544	\$ 31,769	Y	N			
EDN150	7/24/2012		56679	Educ Asst III	Y	SR12	03	P	0.750	A	\$ 18,338	\$ 19,250	Y	Y	2		
EDN150	10/19/2013		58118	Educ Asst III	Y	SR12	03	P	0.750	A	\$ 19,056	\$ 19,599	Y	N			
EDN150	11/16/2011		58139	Educ Asst III	Y	SR12	03	P	0.750	A	\$ 18,338	\$ 19,250	Y	Y	6		
EDN400	10/30/2010		9463	Cafeteria Helper	N	BC02	01	P	0.500	A	\$ 16,614	\$ 16,614	Y	N			
EDN150	7/31/2013		56704	Educ Asst III	Y	SR12	03	T	1.000	A	\$ 24,450	\$ 27,154	Y	N			
EDN150	6/29/2013		57361	Educ Asst III	Y	SR12	03	T	1.000	A	\$ 25,407	\$ 27,154	Y	N			
EDN150	7/31/2013		800279	Educ Asst III	Y	SR12	03	T	0.750	A	\$ 18,338	\$ 20,366	Y	N			
EDN150	6/29/2013		57338	Educ Asst III	Y	SR12	03	T	0.750	A	\$ 18,339	\$ 18,111	Y	N			
EDN150	9/12/2011		55279	Educ Asst III	Y	SR12	03	T	0.750	A	\$ 18,338	\$ 20,366	Y	N			
EDN150	5/29/2013		57357	Educ Asst III	Y	SR12	03	T	0.750	A	\$ 18,338	\$ 18,111	Y	N			
EDN150	6/21/2013		56701	Educ Asst III	Y	SR12	03	T	0.750	A	\$ 19,796	\$ 21,157	Y	N			
EDN150	11/18/2013		802756	Educ Asst III	Y	SR12	03	T	0.750	A	\$ 18,773	\$ 19,599	Y	N			
EDN150	6/29/2013		57029	Educ Asst III	Y	SR12	03	T	0.750	A	\$ 18,338	\$ 19,599	Y	N			
EDN150	8/19/2013		57336	Educ Asst III	Y	SR12	03	T	0.750	A	\$ 18,338	\$ 18,815	Y	N			
EDN100	6/15/2013		801114	Athletic Hlth Care Trainer	Y	SR22	13	P	1.000	A	\$ 42,073	\$ 45,576	Y	N			
EDN100	7/1/2012		802760	Athletic Hlth Care Trainer	Y	SR22	13	P	0.500	A	\$ 22,788	\$ -	Y	N			
EDN150	12/29/2012		50786	Educ Asst III	Y	SR12	03	T	0.750	A	\$ 20,609	\$ 22,026	Y	N			
EDN150	7/1/2010		800924	Educ Asst III	Y	SR12	03	T	0.750	A	\$ 18,338	\$ 19,599	Y	N			
EDN150	2/16/2013		58008	Educ Asst III	Y	SR12	03	T	0.750	A	\$ 20,609	\$ 22,026	Y	N			
EDN150	7/30/2013		802337	Educ Asst III	Y	SR12	03	P	1.000	A	\$ 24,450	\$ 25,667	Y	Y	2		
EDN150	10/12/2012		802783	Educ Asst III	Y	SR12	03	T	1.000	A	\$ 25,030	\$ -	Y	N			
EDN150	8/6/2013		800926	Educ Asst III	Y	SR12	03	T	0.750	A	\$ 18,338	\$ 20,366	Y	N			
EDN150	8/31/2013		52682	Educ Asst III	Y	SR12	03	P	0.750	A	\$ 22,294	\$ 24,774	Y	N			
EDN150	4/14/2012		46939	Educ Asst III	Y	SR12	03	P	0.750	A	\$ 18,338	\$ 19,599	Y	N			
EDN150	7/25/2012		800928	Educ Asst III	Y	SR12	03	T	0.750	A	\$ 18,338	\$ 19,599	Y	N			
EDN150	8/16/2012		58007	Educ Asst III	Y	SR12	03	T	0.750	A	\$ 18,338	\$ 19,599	Y	N			
EDN150	12/8/2012		55659	Educ Asst III	Y	SR12	03	P	0.500	A	\$ 12,226	\$ 12,834	Y	Y	4		
EDN150	7/14/2012		57437	Educ Asst III	Y	SR12	03	T	1.000	A	\$ 28,544	\$ 25,667	Y	Y	6		
EDN150	9/12/2013		58971	Educ Asst III	Y	SR12	03	P	0.750	A	\$ 20,609	\$ 19,250	Y	Y	1		
EDN150	10/1/2013		802702	Educ Asst III	Y	SR12	03	P	0.750	A	\$ 18,773	\$ 19,250	Y	Y	2		
EDN150	10/1/2013		802907	Educ Asst III	Y	SR12	03	P	0.500	A	\$ 12,515	\$ 12,834	Y	Y	3		
EDN150	12/29/2012		30843	Human Svcs Prof IV	N	SR22	13	P	1.000	A	\$ 48,677	\$ 52,694	Y	N			
EDN150	11/30/2013		45845	Educ Asst III	Y	SR12	03	P	0.750	A	\$ 18,338	\$ 20,366	Y	N			
EDN150	7/28/2012		55735	Educ Asst III	Y	SR12	03	P	0.750	A	\$ 20,609	\$ 22,864	Y	N			
EDN150	1/1/2013		55741	Educ Asst III	Y	SR12	03	T	1.000	A	\$ 24,450	\$ 27,058	Y	N			
EDN150	8/7/2012		802714	Educ Asst III	Y	SR12	03	P	0.750	A	\$ 18,773	\$ -	Y	N			
EDN100	10/27/2012		52462	Athletic Hlth Care Trainer	Y	SR22	13	P	1.000	A	\$ 42,073	\$ 45,576	Y	N			
EDN150	8/28/2013		56765	Educ Asst III	Y	SR12	03	T	0.500	A	\$ 12,226	\$ 13,577	Y	N			
EDN150	11/20/2013		57467	Educ Asst III	Y	SR12	03	T	0.750	A	\$ 20,609	\$ 19,250	Y	N			
EDN150	9/28/2013		57525	Educ Asst III	Y	SR12	03	T	0.500	A	\$ 13,740	\$ 12,834	Y	N			
EDN150	9/28/2013		800600	Educ Asst III	Y	SR12	03	T	0.500	A	\$ 12,226	\$ 12,834	Y	N			
EDN150	10/1/2013		802798	Educ Asst III	Y	SR12	03	T	0.750	A	\$ 18,773	\$ 19,250	Y	Y	6		
EDN400	6/1/2013		57926	Cafeteria Helper	N	BC02	01	P	0.500	A	\$ 16,614	\$ 16,614	Y	N			
EDN200	11/4/2013		603324	District Educ Spec II	Certificated	3E07	06	T	1.000	A	\$ 77,069	\$ 77,069	Y	N			
EDN150	6/1/2013		56946	Educ Asst III	Y	SR12	03	P	1.000	A	\$ 28,544	\$ 25,667	Y	Y	2		
EDN200	9/4/2012		60024	Educational Spec II	Certificated	3E07	06	P	1.000	A	\$ 71,959	\$ 80,350	Y	N			1
EDN200	7/30/2013		60020	Educational Spec II	Certificated	3E07	06	P	1.000	A	\$ 69,021	\$ 77,069	Y	N			2

Department of Education
Vacant Positions as of November 30, 2013

Table 14

Prog ID	Date of Vacancy	Expected Fill Date	Position Number*	Position Title	Exempt (Y/N)	SR Level	BU Code	Perm Temp (P/T)	FTE	MOF	Budgeted Amount	Actual Salary Last Paid	Authority to Hire (Y/N)	Occupied by 89 Day Hire (Y/N)	# of 89 Hire Appts	Describe if Filled by other Means	Priority # to Retain**
EDN200	9/17/2007		66356	Educ Admin Svcs Director	Certificated	3E10	06	P	1.000	A	\$ 78,320	\$ 77,259	Y	N			3
EDN150	12/1/2007		66419	Educational Spec II	Certificated	3E07	06	P	1.000	A	\$ 71,060	\$ 88,782	Y	N			4
EDN200	7/1/2013		60081	Educational Spec III	Certificated	3E08	06	P	1.000	A	\$ 99,073	\$ 110,626	Y	N			5
EDN200	7/1/2013		73056	Educational Spec II	Certificated	3E07	06	P	1.000	A	\$ 89,886	\$ 100,367	Y	N			6
EDN200	10/22/2012		19184	Television Production Tech	N	SR13	03	P	1.000	A	\$ 30,395	\$ 33,756	Y	N			7
EDN200	5/28/2011		61233	State Office Teacher	Certificated	T06	05	P	1.000	A	\$ 39,826	\$ 62,002	Y	N			8
EDN100	11/28/2011		74841	State Office Teacher	Certificated	T04	05	T	1.000	A	\$ 39,774	\$ 46,451	Y	N			9
EDN150	1/28/2013		802931	Educ Asst III	Y	SR12	03	P	1.000	A	\$ 25,030	\$ -	Y	N			10
EDN150	1/28/2013		802932	Educ Asst III	Y	SR12	03	P	1.000	A	\$ 25,030	\$ -	Y	N			11
EDN150	1/28/2013		802933	Educ Asst III	Y	SR12	03	P	1.000	A	\$ 25,030	\$ -	Y	N			12
EDN150	1/28/2013		802934	Educ Asst III	Y	SR12	03	P	1.000	A	\$ 25,030	\$ -	Y	N			13
EDN300	11/1/2013		1813	Accountant V	N	SR24	13	P	1.000	A	\$ 63,107	\$ 53,373	Y	N			1
EDN300	9/27/2012		37315	Pre Audit Clerk II	N	SR13	03	P	1.000	A	\$ 28,049	\$ 31,221	Y	Y	5		2
EDN300	8/16/2013		59797	Accountant IV	N	SR22	13	P	1.000	A	\$ 45,576	\$ 47,400	Y	N			3
EDN300	3/30/2013		16262	Pre Audit Clerk II	N	SR13	03	P	1.000	A	\$ 36,881	\$ 41,040	Y	N			4
EDN300	5/1/2013		21917	Pre Audit Clerk II	N	SR13	03	P	1.000	A	\$ 30,335	\$ 33,756	Y	N			5
EDN300	8/23/2012		35480	Pre Audit Clerk II	N	SR13	03	P	1.000	A	\$ 35,479	\$ 39,480	Y	N			6
EDN300	11/1/2013		54956	Pre Audit Clerk II	N	SR13	03	P	1.000	A	\$ 36,881	\$ 42,684	Y	N			7
EDN300	10/9/2013		73073	Personnel Specialist II	Certificated	3E07	06	P	1.000	A	\$ 69,717	\$ 78,146	Y	N			1
EDN300	9/7/2013		59118	Personnel Mgmt Specialist V	N	SR24	13	P	1.000	A	\$ 45,896	\$ 55,488	Y	N			2
EDN200	10/1/2012		76280	Educational Spec II	Certificated	3E07	06	P	1.000	A	\$ 71,744	\$ 78,146	Y	N			3
EDN300	11/1/2013		58722	Personnel Mgmt Specialist IV	N	SR22	13	P	1.000	A	\$ 40,766	\$ 47,400	Y	N			4
EDN300	12/2/2013		15361	Personnel Clerk V	N	SR13	03	P	1.000	A	\$ 42,977	\$ 32,424	Y	N			5
EDN300	9/29/2012		58576	Personnel Clerk V	N	SR13	03	P	1.000	A	\$ 33,961	\$ 31,221	Y	Y	4		6
EDN300	8/26/2013		19131	Personnel Clerk V	N	SR13	03	P	1.000	A	\$ 27,918	\$ 31,221	Y	Y	2		7
EDN300	11/18/2013		58221	Personnel Clerk V	N	SR13	03	P	1.000	A	\$ 29,002	\$ 31,221	Y	Y	1		8
EDN100	12/16/2011		50395	Personnel Clerk IV	N	SR11	03	P	1.000	A	\$ 26,633	\$ 28,829	Y	Y	1		9
EDN300	7/1/2013		59529	Personnel Clerk III	N	SR09	03	P	0.500	A	\$ 13,510	\$ 15,606	Y	N			10
EDN300	12/2/2011		58233	Personnel Clerk III	N	SR09	03	P	1.000	A	\$ 24,019	\$ 31,212	Y	N			11
EDN300	1/28/2013		51561	Personnel Clerk III	N	SR09	03	P	1.000	A	\$ 27,021	\$ 26,707	Y	Y	3		12
EDN300	5/2/2011		17560	Secretary IV	N	SR18	03	P	1.000	A	\$ 29,128	\$ 46,176	Y	N			13
EDN300	7/30/2013		73927	12-Mo State Off Tchr	Certificated	T	05	P	1.000	A	\$ 65,605	\$ 60,166	Y	N			14
EDN300	8/1/2013		73903	12-Mo State Off Tchr	Certificated	T	05	P	1.000	A	\$ 65,605	\$ 73,891	Y	N			15
EDN300	6/1/2013		73533	12-Mo State Off Tchr	Certificated	T	05	P	1.000	A	\$ 76,052	\$ 83,213	Y	N			16
EDN300	11/27/2008		73633A	Personnel Specialist II	Certificated	3E07	06	P	0.500	A	\$ 34,691	\$ 54,549	Y	N			17
EDN300	6/1/2013		604607	OITS Executive Assistant	Certificated	3E10	06	P	1.000	A	\$ 87,340	\$ -	Y	N			1
EDN300	12/31/2006		60014	Information Technology Director	Certificated	3E10	06	P	1.000	A	\$ 72,204	\$ 87,774	Y	N			2
EDN300	11/26/2012		73596	Educational Spec II	Certificated	3E07	06	T	1.000	A	\$ 85,313	\$ 94,937	Y	N			3
EDN300	10/14/2013		604213	Data Proc Spec III	Certificated	3E08	06	P	1.000	A	\$ 80,350	\$ -	Y	N			4
EDN300	10/31/2013		604341	Telecomm Network Spec II	Certificated	3E07	06	P	1.000	A	\$ 77,069	\$ -	Y	N			5
EDN300	2/25/2013		60067	Information Spec II	Certificated	3E07	06	P	1.000	A	\$ 81,669	\$ 91,060	Y	N			6
EDN300	10/1/2013		30541	Automated Systems Equip Supv	N	F114	02	P	1.000	A	\$ 53,703	\$ 62,676	Y	N			7
EDN300	10/1/2013		800753	Data Procsg Svcs Anal V	N	SR24	13	P	1.000	A	\$ 47,544	\$ 55,488	Y	N			8
EDN300	8/1/2013		44944	DP User Support Tech II	N	SR15	03	P	1.000	A	\$ 35,408	\$ 41,040	Y	N			9
EDN300	8/1/2013		23740	Data Procsg Svcs Anal IV	N	SR22	13	P	1.000	A	\$ 40,956	\$ 43,812	Y	N			10
EDN300	9/20/2012		42580	Automated Svcs Equip Tech I	N	BC14	01	P	1.000	A	\$ 47,704	\$ 54,600	Y	Y	5		11
EDN400	4/27/2013		105	Planner V	N	SR24	13	P	1.000	A	\$ 46,100	\$ 51,312	Y	N			1
EDN400	8/1/2013		33949	Secretary II	N	SR14	03	P	1.000	A	\$ 29,187	\$ 36,516	Y	N			1

Department of Education
 Vacant Positions as of November 30, 2013

Table 14

Prog ID	Date of Vacancy	Expected Fill Date	Position Number*	Position Title	Exempt (Y/N)	SR Level	BU Code	Perm Temp (P/T)	FTE	MOF	Budgeted Amount	Actual Salary Last Paid	Authority to Hire (Y/N)	Occupied by 89 Day Hire (Y/N)	# of 89 Hire Appts	Describe if Filled by other Means	Priority # to Retain**
EDN400	6/29/2013		59887	Energy Conservation Coord	N	SR24	13	P	1.000	A	\$ 36,756	\$ 51,314	Y	N			1
EDN400	3/19/2012		17166	Electrician I	N	BC10	01	P	1.000	A	\$ 41,524	\$ 49,320	Y	N			1
EDN400	8/7/2012		802721	Office Assistant III	N	SR08	03	P	1.000	A	\$ 25,668	\$ -	Y	N			2
EDN400	12/1/2011		17167	Electrician I	N	BC10	01	P	1.000	A	\$ 41,524	\$ 49,320	Y	N			2
EDN400	8/7/2012		802723	Office Assistant III	N	SR08	03	P	1.000	A	\$ 25,668	\$ -	Y	N			3
EDN400	7/1/2010		17175	Electrician I	N	BC10	01	P	1.000	A	\$ 41,524	\$ 49,320	Y	N			3
EDN400	1/14/2010		39787	Electrician I	N	BC10	01	P	1.000	A	\$ 41,524	\$ 49,320	Y	N			4
EDN400	4/25/2013		802231	Account Clerk III	N	SR11	03	P	1.000	A	\$ 24,003	\$ 46,176	Y	N			4
EDN400	5/1/2013		17199	General Laborer II	N	BC03	01	P	1.000	A	\$ 30,682	\$ 34,840	Y	Y	2		21
EDN400	6/1/2013		17063	Office Assistant IV	N	SR10	03	P	1.000	A	\$ 24,927	\$ 27,747	Y	Y	2		26
EDN400	7/1/2005		36849	Tractor Operator	N	BC04	01	T	1.000	A	\$ 31,922	\$ -	Y	N			35
EDN400	3/1/2012		16808	Power Mower Operator I	N	BC03	01	P	1.000	A	\$ 30,682	\$ 34,840	Y	Y	3		40
EDN400	7/5/2011		16810	Power Mower Operator I	N	BC03	01	P	1.000	A	\$ 30,682	\$ 34,840	Y	Y	3		41
EDN400	11/1/2012		44200	Power Mower Operator I	N	BC03	01	P	1.000	A	\$ 30,682	\$ 34,840	Y	Y	3		42
EDN300	8/12/2013		72804	Civ Rights Compl Spec II	Certificated	3E07	06	P	1.000	A	\$ 78,460	\$ 87,340	Y	N			1
EDN200	11/4/2013		60079	Test Dev Spec II	Certificated	3E07	06	P	1.000	A	\$ 69,823	\$ 78,146	Y	N			2
EDN200	9/28/2013		48871	Research Statistician IV	N	SR22	13	P	1.000	A	\$ 47,573	\$ 47,403	Y	N			3
* General funded positions vacant as of November 30, 2013.																	
** The Priority to Retain column does not include priority ranking for school-level and complex area-level positions. Priority rankings are provided for State Office positions vacant as of November 30, 2013. State Offices provided priority ranking of positions within its own office, independent of priority rankings provided for other State Office positions.																	

Department of Education
Personnel Separations

Table 15

<u>Prog ID/Org</u>	<u>Separation Date</u>	<u>Position Number</u>	<u>Position Title</u>	<u>Exempt (Y/N)</u>	<u>SR Level</u>	<u>BU Code</u>	<u>T/P</u>	<u>MOF</u>	<u>Budgeted FTE</u>	<u>Budgeted Salary</u>	<u>Actual FTE</u>	<u>Actual Salary</u>
EDN100/AA	7/1/2011	801728	LIBRARY ASSISTANT II	N	SR05	03	T	A			0.50	11,388
EDN100/AA	7/1/2011	801631	EDUC ASST II	Y	SR10	03	T	A			0.50	11,565
EDN150/FA	7/1/2011	801901	EDUC ASST III	Y	SR12	03	T	A			0.50	11,890
EDN150/FA	7/1/2011	801900	EDUC ASST III	Y	SR12	03	T	A			0.50	12,515
EDN100/AA	7/1/2011	48420	CLERK TYPIST II	N	SR08	03	P	A	0.50	16,212	0.50	12,834
EDN100/AA	7/1/2011	56599	CLERK TYPIST II	N	SR08	03	P	A	0.50	12,834	0.50	12,834
EDN150/FA	7/1/2011	54846	EDUC ASST I	Y	SR08	03	P	A	0.63	16,332	0.63	13,369
EDN500/PC	7/1/2011	36399	CLERK TYPIST II	N	SR08	03	T	A			0.48	13,697
EDN200/GN	7/1/2011	32159	BILINGUAL/BICULTURAL S/H ASST	Y	SR11	03	T	A	0.50	15,606	0.50	15,606
EDN200/GN	7/1/2011	32136	BILINGUAL/BICULTURAL S/H ASST	Y	SR11	03	T	A	0.50	15,606	0.50	15,606
EDN100/AA	7/1/2011	800758	EDUC ASST I	Y	SR08	03	T	A	0.75	19,599	0.75	16,043
EDN150/NB	7/1/2011	801743	EDUC ASST III	Y	SR12	03	T	N			0.75	18,773
EDN150/FA	7/1/2011	800284	EDUC ASST III	Y	SR12	03	T	A	0.75	19,599	0.75	18,773
EDN100/AA	7/1/2011	801624	EDUC ASST III	Y	SR12	03	T	A			0.75	18,773
EDN150/FA	7/1/2011	57768	EDUC ASST III	Y	SR12	03	T	A	0.75	19,599	0.75	18,773
EDN150/FA	7/1/2011	56738	EDUC ASST III	Y	SR12	03	T	A	0.75	19,599	0.75	18,773
EDN100/AA	7/1/2011	801350	SCHOOL SECURITY ATTENDANT	N	SR07	03	T	A			1.00	19,510
EDN150/FA	7/1/2011	57579	EDUC ASST II	Y	SR10	03	T	A	0.88	22,865	0.88	20,239
EDN150/FA	7/1/2011	57211	EDUC ASST III	Y	SR12	03	T	A	0.75	21,157	0.75	20,265
EDN150/FA	7/1/2011	58116	EDUC ASST III	Y	SR12	03	P	A	0.75	22,026	0.75	21,097
EDN150/FA	7/1/2011	58809	EDUC ASST I	Y	SR08	03	T	A	1.00	26,131	1.00	21,390
EDN150/FA	7/1/2011	57251	EDUC ASST III	Y	SR12	03	P	A	0.75	22,879	0.75	21,915
EDN150/FA	7/1/2011	57763	EDUC ASST III	Y	SR12	03	T	A	0.75	22,879	0.75	21,915
EDN100/CB	7/1/2011	33985	SCHOOL HEALTH AIDE	N	SR09	03	P	A	1.00	24,786	1.00	22,555
EDN150/NB	7/1/2011	801457	EDUC ASST II	Y	SR10	03	T	N			1.00	23,130
EDN150/FA	7/1/2011	801952	EDUC ASST II	Y	SR10	03	T	A			1.00	23,130
EDN100/AA	7/1/2011	55116	CLERK II	N	SR06	03	T	A			1.00	23,688
EDN150/FA	7/1/2011	52547	EDUC ASST III	Y	SR12	03	P	A	1.00	30,506	1.00	25,030
EDN150/FA	7/1/2011	801949	EDUC ASST III	Y	SR12	03	T	A			1.00	25,030
EDN150/FA	7/1/2011	56039	EDUC ASST III	Y	SR12	03	T	A	1.00	26,131	1.00	25,030
EDN150/FA	7/1/2011	56926	EDUC ASST III	Y	SR12	03	T	A	1.00	26,131	1.00	25,030
EDN150/FA	7/1/2011	56874	EDUC ASST III	Y	SR12	03	T	A	1.00	26,131	1.00	25,030
EDN150/FA	7/1/2011	58869	EDUC ASST III	Y	SR12	03	T	A	1.00	26,131	1.00	25,030
EDN150/FA	7/1/2011	55037	EDUC ASST III	Y	SR12	03	T	A	1.00	26,131	1.00	25,030
EDN150/FA	7/1/2011	800581	EDUC ASST III	Y	SR12	03	T	A	1.00	26,131	1.00	25,030
EDN150/FA	7/1/2011	56831	EDUC ASST III	Y	SR12	03	T	A	1.00	26,131	1.00	25,030
EDN150/FA	7/1/2011	56032	EDUC ASST III	Y	SR12	03	P	A	1.00	30,506	1.00	25,030
EDN150/FA	7/1/2011	801284	EDUC ASST III	Y	SR12	03	T	A	1.00	26,131	1.00	25,030
EDN150/NB	7/1/2011	801633	EDUC ASST III	Y	SR12	03	T	N			1.00	25,030
EDN150/NB	7/1/2011	58150	EDUC ASST III	Y	SR12	03	T	N			1.00	25,030
EDN150/FA	7/1/2011	58813	EDUC ASST III	Y	SR12	03	T	A	1.00	26,131	1.00	25,030
EDN100/AA	7/1/2011	801676	EDUC ASST III	Y	SR12	03	T	A			1.00	25,030
EDN150/FA	7/1/2011	801289	EDUC ASST III	Y	SR12	03	T	A	1.00	26,131	1.00	25,030
EDN150/NB	7/1/2011	57707	EDUC ASST III	Y	SR12	03	T	N			1.00	25,030
EDN150/FA	7/1/2011	56928	EDUC ASST III	Y	SR12	03	T	A	1.00	26,131	1.00	25,030

<u>Prog ID/Org</u>	<u>Separation Date</u>	<u>Position Number</u>	<u>Position Title</u>	<u>Exempt (Y/N)</u>	<u>SR Level</u>	<u>BU Code</u>	<u>T/P</u>	<u>MOF</u>	<u>Budgeted FTE</u>	<u>Budgeted Salary</u>	<u>Actual FTE</u>	<u>Actual Salary</u>
EDN100/AA	7/1/2011	801921	EDUC ASST III	Y	SR12	03	T	A			1.00	25,030
EDN150/FA	7/1/2011	57247	EDUC ASST III	Y	SR12	03	T	A	1.00	28,209	1.00	25,030
EDN400/MD	7/1/2011	801150	CLERK TYPIST II	N	SR08	03	T	N	1.00	25,668	1.00	25,668
EDN300/KC	7/1/2011	102118	MEMBER BOE	N	SRNA	N/A	T	A			0.10	25,668
EDN100/AA	7/1/2011	55672	EDUC ASST II	Y	SR10	03	T	A			1.00	25,670
EDN150/FA	7/1/2011	800099	EDUC ASST III	Y	SR12	03	T	A	1.00	27,154	1.00	26,010
EDN150/FA	7/1/2011	56886	EDUC ASST III	Y	SR12	03	T	A	1.00	27,154	1.00	26,010
EDN100/AA	7/1/2011	800940	CLERK TYPIST II	N	SR08	03	T	A	1.00	26,700	1.00	26,700
EDN150/FA	7/1/2011	57322	EDUC ASST III	Y	SR12	03	T	A	1.00	28,209	1.00	27,020
EDN150/FA	7/1/2011	57091	EDUC ASST III	Y	SR12	03	T	A	1.00	29,368	1.00	28,130
EDN100/AA	7/1/2011	57996	LIBRARY ASSISTANT III	N	SR07	03	P	A	1.00	28,836	1.00	28,836
EDN100/AA	7/1/2011	54874	CLERK III	N	SR08	03	T	A	1.00	30,036	1.00	30,036
EDN100/AA	7/1/2011	45322	EDUC ASST III	Y	SR12	03	P	A	1.00	31,769	1.00	30,430
EDN150/FA	7/1/2011	56844	EDUC ASST III	Y	SR12	03	T	A	1.00	32,424	1.00	32,424
EDN150/FA	7/1/2011	73918	SPEC ED TEACHER	Certificated	T02	05	P	A	1.00	32,713	1.00	32,713
EDN100/AA	7/1/2011	51991	EDUC ASST III	Y	SR12	03	P	A	1.00	35,705	1.00	34,200
EDN100/AA	7/1/2011	16170	SCHOOL CUSTODIAN III	N	WS02	01	P	A	1.00	35,544	1.00	35,544
EDN100/AA	7/1/2011	36388	CLERK TYPIST II	N	SR08	03	P	A	1.00	37,968	1.00	37,968
EDN100/AA	7/1/2011	16183	SCHOOL CUSTODIAN IV	N	F102	02	P	A	1.00	42,072	1.00	38,160
EDN400/MD	7/1/2011	9418	SCHOOL COOK II	N	BC06	01	P	A			1.00	38,436
EDN500/PC	7/1/2011	8267	CLERK TYPIST II	N	SR08	03	P	A	1.00	39,480	1.00	39,480
EDN150/FA	7/1/2011	68213	SPEC ED TEACHER	Certificated	T02	05	P	A	1.00	62,550	1.00	40,567
EDN300/KO	7/1/2011	19131	PERSONNEL CLERK V	N	SR13	03	P	A	1.00	41,040	1.00	41,040
EDN100/AA	7/1/2011	1883	SCHOOL ADM SERVICES ASST II	Certificated	SR14	04	P	A	1.00	44,412	1.00	42,192
EDN100/AA	7/1/2011	68490	SECONDARY TEACHER	Certificated	T02	05	P	A	1.00	43,157	1.00	42,509
EDN150/FA	7/1/2011	74080	SPEC ED TEACHER	Certificated	T02	05	P	A	1.00	79,170	1.00	42,509
EDN150/FA	7/1/2011	72528	12-MO SPEC ED TEACHER	Certificated	T02	05	P	A	1.00	51,788	1.00	43,157
EDN100/AA	7/1/2011	65745	SECONDARY TEACHER	Certificated	T03	05	P	A	1.00	46,609	1.00	46,609
EDN100/AA	7/1/2011	69953	SECONDARY TEACHER	Certificated	T03	05	P	A	1.00	49,448	1.00	46,609
EDN100/AA	7/1/2011	66435	ELEM TEACHER	Certificated	T03	05	P	A	1.00	46,609	1.00	46,609
EDN400/MD	7/1/2011	47901	SCHOOL FOOD SERVICES MGR IV	N	F306	02	P	A	1.00	52,607	1.00	48,672
EDN100/AA	7/1/2011	65861	SECONDARY TEACHER	Certificated	T03	05	T	A	1.00	49,448	1.00	49,448
EDN150/FA	7/1/2011	75613	GEN EDUC/ARTICLE VI TCHR	Certificated	T03	05	T	A	1.00	49,448	1.00	49,448
EDN150/NB	7/1/2011	79979	12-MO DIST OFF TCHR	Certificated	T03	05	T	N			1.00	49,448
EDN100/AA	7/1/2011	60387	SECONDARY TEACHER	Certificated	T03	05	P	A	1.00	49,448	1.00	49,448
EDN150/FA	7/1/2011	64643	SPEC ED TEACHER	Certificated	T04	05	P	A	1.00	49,928	1.00	49,928
EDN100/AA	7/1/2011	60277	ELEM TEACHER	Certificated	T03	05	P	A	1.00	50,931	1.00	50,931
EDN100/AA	7/1/2011	64403	ELEM TEACHER	Certificated	T04	05	P	A	1.00	52,721	1.00	51,426
EDN150/NB	7/1/2011	79577	12-MO DIST OFF TCHR	Certificated	T04	05	T	N			1.00	51,426
EDN100/AA	7/1/2011	75281	12-MO STUDENT SVCS COORD	Certificated	T04	05	T	A	1.00	61,711	1.00	51,426
EDN150/YC	7/1/2011	58300	CLINICAL PSYCHOLOGIST VI	N	SR26	13	T	A	1.00	68,160	1.00	52,728
EDN150/FA	7/1/2011	74560	SPEC ED TEACHER	Certificated	T04	05	P	A	1.00	52,968	1.00	52,968
EDN100/AA	7/1/2011	67199	12-MONTH REGISTRAR	Certificated	T04	05	P	A	1.00	63,562	1.00	52,968
EDN150/NB	7/1/2011	79955	12-MO DIST OFF TCHR	Certificated	T05	05	T	N			1.00	53,483
EDN100/AA	7/1/2011	10349	SCHOOL ADM SERVICES ASST III	Certificated	SR16	04	P	A	1.00	54,012	1.00	54,012

<u>Prog ID/Org</u>	<u>Separation Date</u>	<u>Position Number</u>	<u>Position Title</u>	<u>Exempt (Y/N)</u>	<u>SR Level</u>	<u>BU Code</u>	<u>T/P</u>	<u>MOF</u>	<u>Budgeted FTE</u>	<u>Budgeted Salary</u>	<u>Actual FTE</u>	<u>Actual Salary</u>
EDN100/AA	7/1/2011	73971	12-MO SECONDARY TEACHER	Certificated	T05	05	P	A	1.00	66,104	1.00	55,087
EDN100/AA	7/1/2011	62439	SECONDARY TEACHER	Certificated	T06	05	P	A	1.00	55,622	1.00	55,622
EDN100/AA	7/1/2011	71546	ELEM TEACHER	Certificated	T06	05	P	A	1.00	43,157	1.00	55,622
EDN100/AA	7/1/2011	64494	COUNSELOR	Certificated	T05	05	P	A	1.00	56,740	1.00	56,740
EDN100/AA	7/1/2011	60773	SECONDARY TEACHER	Certificated	T06	05	P	A	1.00	57,291	1.00	57,291
EDN100/AA	7/1/2011	65149	SECONDARY TEACHER	Certificated	T04	05	P	A	1.00	57,880	1.00	57,880
EDN400/OC	7/1/2011	10127	SECRETARY IV	N	SR18	03	P	A	1.00	58,440	1.00	58,440
EDN100/AA	7/1/2011	76243	ELEM TEACHER	Certificated	T05	05	P	A	1.00	58,442	1.00	58,442
EDN150/FA	7/1/2011	72410	SPEC ED TEACHER	Certificated	T07	05	P	A	1.00	60,004	1.00	58,959
EDN100/AA	7/1/2011	66033	ELEM TEACHER	Certificated	T04	05	P	A	1.00	62,450	1.00	60,483
EDN150/FA	7/1/2011	67852	SPEC ED TEACHER	Certificated	T07	05	P	A	1.00	60,729	1.00	60,729
EDN100/AA	7/1/2011	71215	ELEM TEACHER	Certificated	T03	05	P	A	1.00	60,815	1.00	60,815
EDN150/FA	7/1/2011	68721	GEN EDUC/ARTICLE VI TCHR	Certificated	T02	05	P	A	1.00	61,479	1.00	61,479
EDN150/FA	7/1/2011	76074	SPEC ED TEACHER	Certificated	T06	05	P	A	1.00	62,603	1.00	61,663
EDN100/AA	7/1/2011	68089	ELEM TEACHER	Certificated	T07	05	P	A	1.00	63,845	1.00	62,550
EDN100/AA	7/1/2011	67377	ELEM TEACHER	Certificated	T07	05	T	A	1.00	62,550	1.00	62,550
EDN150/FA	7/1/2011	66472	SPEC ED TEACHER	Certificated	T07	05	P	A	1.00	62,550	1.00	62,550
EDN100/AA	7/1/2011	74213	SECONDARY TEACHER	Certificated	T05	05	P	A	1.00	63,861	1.00	63,861
EDN100/AA	7/1/2011	61879X	12-MO STUDENT SVCS COORD	Certificated	T07	05	T	A	1.00	82,022	1.00	68,351
EDN100/AA	7/1/2011	60904	LIBRARIAN	Certificated	T07	05	P	A	1.00	69,646	1.00	68,351
EDN100/AA	7/1/2011	71153	ELEM TEACHER	Certificated	T07	05	P	A	1.00	68,351	1.00	68,351
EDN100/AA	7/1/2011	71040	ELEM TEACHER	Certificated	T07	05	P	A	1.00	43,157	1.00	68,351
EDN100/AA	7/1/2011	63240	SECONDARY TEACHER	Certificated	T07	05	P	A	1.00	68,351	1.00	68,351
EDN100/AA	7/1/2011	66255	ELEM TEACHER	Certificated	T06	05	P	A	1.00	68,408	1.00	68,408
EDN100/AA	7/1/2011	73014	12-MO STUDENT SVCS COORD	Certificated	T04	05	T	A	1.00	82,865	1.00	69,054
EDN100/AA	7/1/2011	73818	SECONDARY TEACHER	Certificated	T04	05	P	A	1.00	69,054	1.00	69,054
EDN100/AA	7/1/2011	60403	SECONDARY TEACHER	Certificated	T07	05	P	A	1.00	70,400	1.00	70,400
EDN150/FA	7/1/2011	63219	GEN EDUC/ARTICLE VI TCHR	Certificated	T07	05	P	A	1.00	70,400	1.00	70,400
EDN100/AA	7/1/2011	60154	ELEM TEACHER	Certificated	T07	05	P	A	1.00	70,400	1.00	70,400
EDN100/AA	7/1/2011	65128	ELEM TEACHER	Certificated	T07	05	P	A	1.00	70,400	1.00	70,400
EDN150/FA	7/1/2011	73462	SPEC ED TEACHER	Certificated	T05	05	P	A	1.00	71,815	1.00	71,815
EDN100/AA	7/1/2011	63456	ELEM TEACHER	Certificated	T07	05	P	A	1.00	73,558	1.00	72,513
EDN100/AA	7/1/2011	60604	12-MONTH REGISTRAR	Certificated	T07	05	P	A	1.00	87,016	1.00	72,513
EDN100/AA	7/1/2011	73197	SECONDARY TEACHER	Certificated	T07	05	T	A	1.00	72,513	1.00	72,513
EDN100/AA	7/1/2011	62761	ELEM TEACHER	Certificated	T07	05	P	A	1.00	72,513	1.00	72,513
EDN100/AA	7/1/2011	61834	ELEM TEACHER	Certificated	T07	05	P	A	1.00	72,513	1.00	72,513
EDN100/BS	7/1/2011	73398	ROTC INSTRUCTOR	Certificated	ROTC	05	T	A	1.00	86,203	1.00	73,956
EDN100/AA	7/1/2011	64593	12-MONTH REGISTRAR	Certificated	T07	05	P	A	1.00	89,626	1.00	74,688
EDN100/AA	7/1/2011	72973F	12-MO STUDENT SVCS COORD	Certificated	T07	05	T	A	1.00	89,626	1.00	74,688
EDN150/FA	7/1/2011	64809	SPEC ED TEACHER	Certificated	T07	05	T	A			1.00	74,688
EDN100/BG	7/1/2011	60115	SECONDARY TEACHER	Certificated	T06	05	T	A			1.00	74,688
EDN100/AA	7/1/2011	71470	VICE PRINCIPAL I	Certificated	E03	06	P	A	1.00	81,007	1.00	75,108
EDN100/AA	7/1/2011	72411	SECONDARY TEACHER	Certificated	T07	05	P	A	1.00	79,170	1.00	79,170
EDN100/AA	7/1/2011	60629	12-MONTH REGISTRAR	Certificated	T07	05	P	A	1.00	95,004	1.00	79,170
EDN100/AA	7/1/2011	72404	12-MONTH SAC TEACHER	Certificated	T07	05	P	A	1.00	95,004	1.00	79,170

<u>Prog ID/Org</u>	<u>Separation Date</u>	<u>Position Number</u>	<u>Position Title</u>	<u>Exempt (Y/N)</u>	<u>SR Level</u>	<u>BU Code</u>	<u>T/P</u>	<u>MOF</u>	<u>Budgeted FTE</u>	<u>Budgeted Salary</u>	<u>Actual FTE</u>	<u>Actual Salary</u>
EDN100/AA	7/1/2011	75233	12-MO STUDENT SVCS COORD	Certificated	T07	05	T	A	1.00	95,004	1.00	79,170
EDN100/BB	7/1/2011	67686	SECONDARY TEACHER	Certificated	T07	05	P	A	1.00	79,170	1.00	79,170
EDN100/AA	7/1/2011	64763	12-MONTH REGISTRAR	Certificated	T07	05	P	A	1.00	95,004	1.00	79,170
EDN100/AA	7/1/2011	64527	12-MONTH REGISTRAR	Certificated	T07	05	P	A	1.00	95,004	1.00	79,170
EDN150/FA	7/1/2011	75868	SPEC ED TEACHER	Certificated	T07	05	P	A	1.00	79,170	1.00	79,170
EDN100/AA	7/1/2011	72086	12-MO STUDENT SVCS COORD	Certificated	T07	05	T	A	1.00	95,004	1.00	79,170
EDN100/AA	7/1/2011	61811	ELEM TEACHER	Certificated	T07	05	P	A	1.00	80,215	1.00	79,170
EDN100/AA	7/1/2011	61717	SECONDARY TEACHER	Certificated	T07	05	T	A	0.50	39,585	1.00	79,170
EDN100/AA	7/1/2011	73092	12-MO STUDENT SVCS COORD	Certificated	T07	05	T	A	1.00	95,004	1.00	79,170
EDN100/AA	7/1/2011	67312	ELEM TEACHER	Certificated	T07	05	P	A	1.00	79,170	1.00	79,170
EDN100/AA	7/1/2011	67947	VICE PRINCIPAL IV	Certificated	E06	06	P	A	1.00	93,089	1.00	86,311
EDN100/AA	7/1/2011	76097	12-MO INTER PRIN IV	Certificated	E07	06	P	A	1.00	108,527	1.00	102,655
EDN400/OC	7/1/2011	60069	CIP PLANNER II	Certificated	E07	06	P	A	1.00	106,105	1.00	106,105
EDN100/AA	7/1/2011	61466	12-MO ELEM PRIN II	Certificated	E06	06	P	A	1.00	119,617	1.00	119,617
EDN100/AA	7/1/2011	73620	12-MO INTER PRIN V	Certificated	E08	06	P	A	1.00	121,294	1.00	121,294
EDN100/AA	7/1/2011	62924	12-MO ELEM PRIN II	Certificated	E06	06	P	A	1.00	124,714	1.00	124,714
EDN100/AA	7/1/2011	66054	12-MO ELEM PRIN II	Certificated	E06	06	P	A	1.00	126,460	1.00	126,460
EDN100/AA	7/1/2011	64609	12-MO INTER PRIN VI	Certificated	E09	06	P	A	1.00	131,843	1.00	131,843
EDN100/AA	7/1/2011	60734	12-MO HS PRIN VII	Certificated	E10	06	P	A	1.00	135,564	1.00	135,564
EDN100/AA	7/2/2011	57660	SCHOOL SECURITY ATTENDANT	N	SR07	03	P	A	1.00	21,444	1.00	20,540
EDN100/AA	7/5/2011	600416	ELEM TEACHER	Certificated	T04	05	T	A			0.50	26,484
EDN400/OC	7/5/2011	16810	POWER MOWER OPERATOR I	N	BC03	01	P	A	1.00	34,164	1.00	34,164
EDN150/YC	7/7/2011	58333	BEHAVIORAL HLTH SPCLT IV	N	SR22	13	P	A	1.00	45,576	1.00	53,352
EDN100/AA	7/9/2011	16703	SCHOOL CUSTODIAN II	N	BC02	01	P	A	1.00	33,228	1.00	33,228
EDN150/YC	7/9/2011	801828	BEHAVIORAL HLTH SPCLT III	N	SR20	13	P	A			1.00	42,132
EDN150/FA	7/9/2011	69648	SPEC ED TEACHER	Certificated	T03	05	P	A	1.00	48,008	1.00	48,008
EDN150/YC	7/9/2011	58309	BEHAVIORAL HLTH SPCLT IV	N	SR22	13	P	A	1.00	55,500	1.00	55,500
EDN400/MD	7/12/2011	50838	CAFETERIA HELPER	N	BC02	01	T	N			0.50	16,614
EDN100/AA	7/13/2011	29332	SCHOOL HEALTH AIDE	N	SR09	03	P	A	1.00	25,812	1.00	24,724
EDN150/SA	7/13/2011	801319	EDUCATIONAL INTERPRETER I	N	SR12	03	P	A	1.00	32,424	1.00	32,424
EDN150/YC	7/13/2011	58377	BEHAVIORAL HLTH SPCLT IV	N	SR22	13	P	A	1.00	57,708	1.00	47,412
EDN150/SA	7/14/2011	56256	SPEECH PATHOLOGIST III	Y	SR20	13	P	A	1.00	58,563	1.00	42,132
EDN100/AA	7/15/2011	55284	CLERK III	N	SR08	03	P	A	0.50	12,834	0.50	12,834
EDN150/FA	7/15/2011	57924	EDUC ASST II	Y	SR10	03	T	A	0.75	19,599	0.75	17,348
EDN150/YC	7/15/2011	58332	BEHAVIORAL HLTH SPCLT IV	N	SR22	13	T	A	0.50	24,666	0.50	24,666
EDN150/FA	7/16/2011	46269	EDUC ASST II	Y	SR10	03	P	A	0.75	19,599	0.75	17,348
EDN150/YG	7/16/2011	800727	HUMAN SVCS PROF IV	N	SR22	13	P	A	1.00	45,576	1.00	45,576
EDN150/YC	7/16/2011	58378	BEHAVIORAL HLTH SPCLT IV	N	SR22	13	P	A	1.00	45,576	1.00	45,576
EDN150/SA	7/16/2011	30407	SPEECH PATHOLOGIST IV	Y	SR22	13	P	A	1.00	69,305	1.00	45,576
EDN150/YC	7/16/2011	29155	SCHOOL PSYCHOLOGIST	Y	SR24	13	P	A	1.00	58,716	1.00	51,312
EDN150/FA	7/16/2011	600005	DIST OFF TCHR	Certificated	T07	05	T	A			1.00	62,550
EDN150/FA	7/21/2011	60304	SPEC ED TEACHER	Certificated	T03	05	P	A	1.00	32,713	1.00	46,609
EDN100/AA	7/23/2011	600773	ELEM TEACHER	Certificated	T02	05	T	A			1.00	32,222
EDN100/AA	7/23/2011	68210	ELEM TEACHER	Certificated	T02	05	T	A	1.00	52,471	1.00	32,713
EDN150/YC	7/23/2011	800467	SCHOOL PSYCHOLOGIST	Y	SR24	13	P	A	1.00	58,716	1.00	51,312

<u>Prog ID/Org</u>	<u>Separation Date</u>	<u>Position Number</u>	<u>Position Title</u>	<u>Exempt (Y/N)</u>	<u>SR Level</u>	<u>BU Code</u>	<u>T/P</u>	<u>MOF</u>	<u>Budgeted FTE</u>	<u>Budgeted Salary</u>	<u>Actual FTE</u>	<u>Actual Salary</u>
EDN100/AA	7/23/2011	61890	ELEM TEACHER	Certificated	T03	05	T	A	1.00	52,460	1.00	52,460
EDN100/AA	7/23/2011	60539	COUNSELOR	Certificated	T06	05	P	A	1.00	55,622	1.00	55,622
EDN150/FA	7/25/2011	75558	GEN EDUC/ARTICLE VI TCHR	Certificated	T05	05	T	A	1.00	46,609	1.00	50,412
EDN150/FA	7/26/2011	57423	EDUC ASST II	Y	SR10	03	T	A	0.75	19,599	0.75	17,348
EDN150/FA	7/26/2011	57530	EDUC ASST III	Y	SR12	03	T	A	0.75	19,599	0.75	17,835
EDN100/CB	7/26/2011	29432	SCHOOL HEALTH AIDE	N	SR09	03	P	A	1.00	18,873	1.00	18,078
EDN150/FA	7/26/2011	800124	EDUC ASST III	Y	SR12	03	T	A	0.75	19,599	0.75	18,773
EDN150/FA	7/26/2011	801294	EDUC ASST III	Y	SR12	03	T	A	0.75	20,366	0.75	19,508
EDN150/FA	7/26/2011	52626	EDUC ASST III	Y	SR12	03	P	A	0.75	22,026	0.75	20,040
EDN100/CB	7/26/2011	29400	SCHOOL HEALTH AIDE	N	SR09	03	P	A	1.00	21,231	1.00	20,336
EDN100/AA	7/26/2011	29378	SCHOOL HEALTH AIDE	N	SR09	03	P	A	1.00	21,231	1.00	20,336
EDN100/CB	7/26/2011	29494	SCHOOL HEALTH AIDE	N	SR09	03	P	A	1.00	22,919	1.00	21,953
EDN150/FA	7/26/2011	57516	EDUC ASST II	Y	SR10	03	T	A	1.00	27,154	1.00	22,830
EDN150/FA	7/26/2011	800195	EDUC ASST II	Y	SR10	03	T	A	1.00	26,131	1.00	23,130
EDN150/FB	7/26/2011	800645	EDUC ASST II	Y	SR10	03	P	A	1.00	27,154	1.00	24,030
EDN150/FA	7/26/2011	801898	EDUC ASST III	Y	SR12	03	T	A			1.00	25,030
EDN150/FA	7/26/2011	57164	EDUC ASST III	Y	SR12	03	T	A			1.00	25,030
EDN150/YG	7/26/2011	800791	EDUC ASST III	Y	SR12	03	P	A	1.00	26,131	1.00	25,030
EDN150/FA	7/26/2011	45189	EDUC ASST III	Y	SR12	03	P	A	1.00	26,131	1.00	25,030
EDN100/AA	7/26/2011	600082	ELEM TEACHER	Certificated	T03	05	T	A			0.50	25,221
EDN100/AA	7/26/2011	52499	EDUC ASST III	Y	SR12	03	P	A	1.00	27,154	1.00	26,010
EDN150/FA	7/26/2011	55323	EDUC ASST III	Y	SR12	03	P	A	1.00	28,209	1.00	27,020
EDN150/FA	7/26/2011	32483	EDUC ASST III	Y	SR12	03	P	A	1.00	28,209	1.00	27,020
EDN150/FA	7/26/2011	37289	EDUC ASST III	Y	SR12	03	P	A	1.00	28,209	1.00	27,020
EDN100/AA	7/26/2011	55849	EDUC ASST III	Y	SR12	03	P	A	1.00	29,368	1.00	28,130
EDN200/GN	7/26/2011	58094	CLERK TYPIST II	N	SR08	03	P	A	1.00	28,836	1.00	28,836
EDN150/FA	7/26/2011	52963	EDUC ASST III	Y	SR12	03	P	A	1.00	31,769	1.00	30,430
EDN150/FA	7/26/2011	53043	EDUC ASST III	Y	SR12	03	P	A	1.00	31,769	1.00	30,430
EDN150/FA	7/26/2011	57799	EDUC ASST III	Y	SR12	03	P	A	1.00	31,769	1.00	30,430
EDN150/YC	7/26/2011	800860	BEHAVIORAL HLTH SPCLT III	N	SR20	13	T	A	1.00	45,576	1.00	42,132
EDN100/AA	7/26/2011	65705	ELEM TEACHER	Certificated	T02	05	P	A	1.00	49,448	1.00	42,509
EDN100/AA	7/26/2011	71955	SECONDARY TEACHER	Certificated	T02	05	P	A	1.00	43,157	1.00	43,157
EDN100/AA	7/26/2011	71874	ELEM TEACHER	Certificated	T02	05	T	A	1.00	49,303	1.00	43,157
EDN100/AA	7/26/2011	600695	ELEM TEACHER	Certificated	T02	05	T	A			1.00	43,157
EDN100/AA	7/26/2011	600316	ELEM TEACHER	Certificated	T02	05	T	A			1.00	45,785
EDN100/AA	7/26/2011	600811	SPEC ED TEACHER	Certificated	T03	05	T	A			1.00	45,909
EDN100/AA	7/26/2011	61387	ELEM TEACHER	Certificated	T03	05	P	A	1.00	68,351	1.00	46,609
EDN150/FA	7/26/2011	60509	SPEC ED TCHR/PRE-SCHOOL	Certificated	T03	05	P	A	1.00	46,609	1.00	46,609
EDN100/AA	7/26/2011	64859	ELEM TEACHER	Certificated	T03	05	T	A	1.00	47,904	1.00	46,609
EDN100/AA	7/26/2011	74002	ELEM TEACHER	Certificated	T03	05	P	A	1.00	60,729	1.00	46,609
EDN100/AA	7/26/2011	65713	ELEM TEACHER	Certificated	T03	05	P	A	1.00	43,157	1.00	48,008
EDN100/AA	7/26/2011	64788	SECONDARY TEACHER	Certificated	T03	05	P	A	1.00	49,448	1.00	48,706
EDN150/SA	7/26/2011	56180	SPEECH PATHOLOGIST IV	Y	SR22	13	P	A	1.00	63,644	1.00	49,332
EDN100/AA	7/26/2011	63970	ELEM TEACHER	Certificated	T03	05	P	A	1.00	49,448	1.00	49,448
EDN150/FA	7/26/2011	64004	SPEC ED TEACHER	Certificated	T03	05	P	A	1.00	43,157	1.00	49,448

Department of Education
Personnel Separations

Table 15

<u>Prog ID/Org</u>	<u>Separation Date</u>	<u>Position Number</u>	<u>Position Title</u>	<u>Exempt (Y/N)</u>	<u>SR Level</u>	<u>BU Code</u>	<u>T/P</u>	<u>MOF</u>	<u>Budgeted FTE</u>	<u>Budgeted Salary</u>	<u>Actual FTE</u>	<u>Actual Salary</u>
EDN150/FA	7/26/2011	72776	SPEC ED TEACHER	Certificated	T03	05	T	A	1.00	49,448	1.00	49,448
EDN100/AA	7/26/2011	68951	ELEM TEACHER	Certificated	T03	05	T	A			1.00	49,448
EDN100/AA	7/26/2011	62439	SECONDARY TEACHER	Certificated	T03	05	P	A	1.00	55,622	1.00	49,448
EDN100/AA	7/26/2011	73540	SECONDARY TEACHER	Certificated	T04	05	P	A	1.00	51,426	1.00	51,426
EDN100/DB	7/26/2011	79611	ELEM TEACHER	Certificated	T04	05	T	N			1.00	51,426
EDN100/AA	7/26/2011	75157	ELEM TEACHER	Certificated	T04	05	T	A	1.00	50,743	1.00	51,426
EDN150/FA	7/26/2011	63505	SPEC ED TEACHER	Certificated	T05	05	T	A			1.00	53,483
EDN150/FA	7/26/2011	74375	SPEC ED TEACHER	Certificated	T05	05	P	A			1.00	53,483
EDN100/AA	7/26/2011	64179	SECONDARY TEACHER	Certificated	T02	05	P	A	1.00	55,714	1.00	54,669
EDN100/AA	7/26/2011	61184	SECONDARY TEACHER	Certificated	T07	05	P	A	1.00	65,004	1.00	58,959
EDN150/FA	7/27/2011	801475	EDUC ASST II	Y	SR10	03	P	A	0.50	13,066	0.50	11,565
EDN100/AA	7/27/2011	36861	EDUC ASST III	Y	SR12	03	P	A	0.50	13,066	0.50	12,515
EDN150/FA	7/27/2011	58119	EDUC ASST I	Y	SR08	03	P	A			0.75	16,043
EDN100/AA	7/27/2011	63131	SECONDARY TEACHER	Certificated	T02	05	T	A	1.00	43,157	0.50	16,356
EDN100/DB	7/27/2011	601850	SECONDARY TEACHER	Certificated	T02	05	T	N			0.50	16,356
EDN100/DB	7/27/2011	600753	ELEM TEACHER	Certificated	T02	05	T	N			0.50	16,356
EDN150/FA	7/27/2011	57541	EDUC ASST II	Y	SR10	03	T	A	0.75	19,599	0.75	17,348
EDN150/FA	7/27/2011	800780	EDUC ASST II	Y	SR10	03	T	A	0.75	19,599	0.75	17,348
EDN150/FA	7/27/2011	57499	EDUC ASST II	Y	SR10	03	T	A	0.75	19,599	0.75	17,348
EDN100/AA	7/27/2011	600161	ELEM TEACHER	Certificated	T03	05	T	A			0.50	17,664
EDN100/AA	7/27/2011	600706	SECONDARY TEACHER	Certificated	T03	05	T	A			0.50	18,741
EDN150/FA	7/27/2011	57356	EDUC ASST III	Y	SR12	03	T	A	0.75	19,599	0.75	18,773
EDN150/FA	7/27/2011	800039	EDUC ASST III	Y	SR12	03	T	A	0.75	19,599	0.75	18,773
EDN100/AA	7/27/2011	62785Z	LIBRARIAN	Certificated	T02	05	P	A	0.50	22,874	0.50	21,255
EDN150/FA	7/27/2011	57430	EDUC ASST III	Y	SR12	03	P	A	0.75	22,879	0.75	21,915
EDN150/YC	7/27/2011	801781	EDUC ASST II	Y	SR10	03	T	A			1.00	23,130
EDN150/FB	7/27/2011	71708	SPECIAL SCH TEACHER	Certificated	T03	05	P	A	0.50	24,724	0.50	23,304
EDN100/AA	7/27/2011	71676	SECONDARY TEACHER	Certificated	T03	05	P	A	0.50	21,579	0.50	24,004
EDN100/AA	7/27/2011	601134	SECONDARY TEACHER	Certificated	T03	05	T	A			0.50	24,004
EDN150/FA	7/27/2011	58771	EDUC ASST II	Y	SR10	03	P	A	1.00	27,154	1.00	24,030
EDN100/AA	7/27/2011	64185	ELEM TEACHER	Certificated	T03	05	P	A	0.50	24,724	0.50	24,724
EDN150/FA	7/27/2011	74151	SPEC ED TEACHER	Certificated	T03	05	P	A			0.50	24,724
EDN150/SA	7/27/2011	30487	COMMUNICATION AIDE	Y	SR12	03	P	A	1.00	26,131	1.00	25,030
EDN150/FA	7/27/2011	801472	EDUC ASST III	Y	SR12	03	P	A	1.00	26,131	1.00	25,030
EDN150/FA	7/27/2011	800617	EDUC ASST III	Y	SR12	03	T	A	1.00	26,131	1.00	25,030
EDN150/YG	7/27/2011	800264	EDUC ASST III	Y	SR12	03	P	A	1.00	26,131	1.00	25,030
EDN100/AA	7/27/2011	53283	EDUC ASST III	Y	SR12	03	P	A	1.00	26,131	1.00	25,030
EDN150/FA	7/27/2011	800397	EDUC ASST III	Y	SR12	03	T	A	1.00	26,131	1.00	25,030
EDN150/FB	7/27/2011	800648	EDUC ASST III	Y	SR12	03	P	A	1.00	26,131	1.00	25,030
EDN150/FA	7/27/2011	56833	EDUC ASST III	Y	SR12	03	P	A	1.00	27,154	1.00	26,010
EDN150/FA	7/27/2011	50802	EDUC ASST II	Y	SR10	03	P	A	1.00	30,506	1.00	27,020
EDN150/FA	7/27/2011	57053	EDUC ASST III	Y	SR12	03	T	A	1.00	28,209	1.00	27,020
EDN150/SA	7/27/2011	30935	COMMUNICATION AIDE	Y	SR12	03	P	A	1.00	28,209	1.00	27,020
EDN150/FA	7/27/2011	800069	EDUC ASST III	Y	SR12	03	T	A	1.00	28,209	1.00	27,020
EDN150/FA	7/27/2011	800202	EDUC ASST III	Y	SR12	03	T	A			1.00	27,020

Department of Education
Personnel Separations

Table 15

Prog ID/Org	Separation Date	Position Number	Position Title	Exempt (Y/N)	SR Level	BU Code	T/P	MOF	Budgeted FTE	Budgeted Salary	Actual FTE	Actual Salary
EDN100/AA	7/27/2011	64976	SECONDARY TEACHER	Certificated	T06	05	P	A			0.50	27,811
EDN150/FA	7/27/2011	57191	EDUC ASST III	Y	SR12	03	T	A	1.00	29,368	1.00	28,130
EDN150/FA	7/27/2011	800062	EDUC ASST III	Y	SR12	03	T	A	1.00	29,368	1.00	28,130
EDN150/FA	7/27/2011	55322	EDUC ASST III	Y	SR12	03	P	A			1.00	29,220
EDN100/AA	7/27/2011	74465	SECONDARY TEACHER	Certificated	T07	05	T	A			0.50	30,365
EDN150/FA	7/27/2011	52736	EDUC ASST III	Y	SR12	03	P	A	1.00	31,769	1.00	30,430
EDN100/AA	7/27/2011	74394	LIBRARIAN	Certificated	T07	05	P	A	0.50	32,570	0.50	31,275
EDN150/FA	7/27/2011	73244	SPEC ED TEACHER	Certificated	T02	05	P	A	1.00	32,713	1.00	32,222
EDN100/AA	7/27/2011	69776	SECONDARY TEACHER	Certificated	T02	05	P	A	1.00	32,713	1.00	32,222
EDN150/FA	7/27/2011	61372	SPEC ED TEACHER	Certificated	T02	05	P	A	1.00	32,713	1.00	32,222
EDN100/AA	7/27/2011	71503	SECONDARY TEACHER	Certificated	T02	05	T	A	1.00	36,463	1.00	32,222
EDN150/FA	7/27/2011	66449	SPEC ED TEACHER	Certificated	T02	05	P	A	1.00	62,550	1.00	32,222
EDN150/FA	7/27/2011	75656	SPEC ED TEACHER	Certificated	T02	05	T	A	1.00	32,713	1.00	32,222
EDN150/FA	7/27/2011	73796	SPEC ED TCHR/PRE-SCHOOL	Certificated	T02	05	P	A	1.00	58,959	1.00	32,222
EDN150/FA	7/27/2011	62041	SPEC ED TEACHER	Certificated	T02	05	P	A	1.00	32,713	1.00	32,222
EDN100/BV	7/27/2011	63194	ELEM TEACHER	Certificated	T02	05	P	A	1.00	32,713	1.00	32,222
EDN150/FA	7/27/2011	68786	SPEC ED TEACHER	Certificated	T02	05	P	A	1.00	49,448	1.00	32,222
EDN100/AA	7/27/2011	71892	SECONDARY TEACHER	Certificated	T02	05	P	A	1.00	32,713	1.00	32,222
EDN150/FA	7/27/2011	66937	SPEC ED TCHR/PRE-SCHOOL	Certificated	T02	05	P	A	1.00	44,452	1.00	32,222
EDN100/AA	7/27/2011	73960	COUNSELOR	Certificated	T02	05	P	A	1.00	51,426	1.00	32,222
EDN150/FA	7/27/2011	64249	SPEC ED TEACHER	Certificated	T02	05	P	A			1.00	32,222
EDN100/AA	7/27/2011	600926	SECONDARY TEACHER	Certificated	T02	05	T	A			1.00	32,222
EDN150/FA	7/27/2011	600191	SPEC ED TEACHER	Certificated	T02	05	T	A			1.00	32,222
EDN150/FA	7/27/2011	75647	SPEC ED TEACHER	Certificated	T02	05	T	A	1.00	51,426	1.00	32,222
EDN100/AA	7/27/2011	64503Z	SECONDARY TEACHER	Certificated	T02	05	P	A	1.00	43,157	1.00	32,222
EDN100/AA	7/27/2011	63629	SECONDARY TEACHER	Certificated	T02	05	P	A	1.00	80,215	1.00	32,222
EDN150/FA	7/27/2011	63168	SPEC ED TEACHER	Certificated	T02	05	P	A	1.00	32,713	1.00	32,713
EDN150/FA	7/27/2011	60197	SPEC ED TEACHER	Certificated	T02	05	P	A	1.00	32,713	1.00	32,713
EDN100/AA	7/27/2011	62268	SECONDARY TEACHER	Certificated	T02	05	P	A	1.00	74,688	1.00	32,713
EDN150/FA	7/27/2011	600218	SPEC ED TEACHER	Certificated	T02	05	T	A			1.00	32,713
EDN150/FA	7/27/2011	74656	SPEC ED TEACHER	Certificated	T02	05	P	A	1.00	32,713	1.00	32,713
EDN100/AA	7/27/2011	65649	SECONDARY TEACHER	Certificated	T02	05	P	A	1.00	32,713	1.00	32,713
EDN100/AA	7/27/2011	68530	ELEM TEACHER	Certificated	T02	05	P	A	1.00	62,550	1.00	32,713
EDN100/AA	7/27/2011	68090	SECONDARY TEACHER	Certificated	T02	05	P	A	1.00	45,785	1.00	32,713
EDN150/FA	7/27/2011	72767	SPEC ED TEACHER	Certificated	T02	05	P	A	1.00	46,609	1.00	32,713
EDN100/DB	7/27/2011	79535	SECONDARY TEACHER	Certificated	T02	05	T	N			1.00	32,713
EDN150/FA	7/27/2011	71151	SPEC ED TEACHER	Certificated	T02	05	P	A	1.00	43,157	1.00	32,713
EDN150/FA	7/27/2011	67200	SPEC ED TEACHER	Certificated	T02	05	P	A	1.00	32,713	1.00	32,713
EDN150/FA	7/27/2011	600278	SPEC ED TEACHER	Certificated	T02	05	T	A			1.00	32,713
EDN100/AA	7/27/2011	600978	SPEC ED TEACHER	Certificated	T02	05	T	A			1.00	32,713
EDN100/AA	7/27/2011	66807	SECONDARY TEACHER	Certificated	T02	05	P	A	1.00	50,743	1.00	32,713
EDN150/FA	7/27/2011	73215	SPEC ED TEACHER	Certificated	T02	05	P	A			1.00	32,713
EDN100/AA	7/27/2011	62548X	SECONDARY TEACHER	Certificated	T02	05	T	A	1.00	43,157	1.00	32,713
EDN150/FA	7/27/2011	71192	SPEC ED TEACHER	Certificated	T02	05	P	A	1.00	49,448	1.00	32,713
EDN100/AA	7/27/2011	75224	10-MO STUDENT SVCS COORD	Certificated	T02	05	T	A			1.00	32,713

Department of Education
Personnel Separations

Table 15

<u>Prog ID/Org</u>	<u>Separation Date</u>	<u>Position Number</u>	<u>Position Title</u>	<u>Exempt (Y/N)</u>	<u>SR Level</u>	<u>BU Code</u>	<u>T/P</u>	<u>MOF</u>	<u>Budgeted FTE</u>	<u>Budgeted Salary</u>	<u>Actual FTE</u>	<u>Actual Salary</u>
EDN150/FA	7/27/2011	64006	SPEC ED TEACHER	Certificated	T02	05	P	A	1.00	52,968	1.00	32,713
EDN150/FA	7/27/2011	71330	SPEC ED TEACHER	Certificated	T02	05	P	A	1.00	45,785	1.00	32,713
EDN150/FA	7/27/2011	73317	SPEC ED TEACHER	Certificated	T02	05	P	A	1.00	46,609	1.00	32,713
EDN100/AA	7/27/2011	600980	SECONDARY TEACHER	Certificated	T02	05	T	A			1.00	32,713
EDN150/FA	7/27/2011	64639	SPEC ED TCHR/PRE-SCHOOL	Certificated	T02	05	P	A	1.00	51,426	1.00	32,713
EDN100/AA	7/27/2011	61856	LIBRARIAN	Certificated	T02	05	P	A	1.00	44,452	1.00	32,713
EDN100/AA	7/27/2011	66681	SECONDARY TEACHER	Certificated	T02	05	P	A	1.00	55,622	1.00	32,713
EDN100/AA	7/27/2011	72152	SECONDARY TEACHER	Certificated	T02	05	P	A	1.00	49,448	1.00	32,713
EDN150/FA	7/27/2011	76075	SPEC ED TEACHER	Certificated	T02	05	P	A	1.00	49,448	1.00	32,713
EDN150/FA	7/27/2011	601031	SPEC ED TEACHER	Certificated	T02	05	T	A			1.00	32,713
EDN100/DB	7/27/2011	79716	SECONDARY TEACHER	Certificated	T02	05	T	N			1.00	32,713
EDN150/FA	7/27/2011	64326	SPEC ED TEACHER	Certificated	T02	05	P	A	1.00	49,448	1.00	32,713
EDN100/AA	7/27/2011	69839	SECONDARY TEACHER	Certificated	T02	05	P	A	1.00	44,452	1.00	32,713
EDN150/FA	7/27/2011	61469	SPEC ED TEACHER	Certificated	T02	05	P	A	1.00	57,291	1.00	32,713
EDN150/FA	7/27/2011	69808	SPEC ED TEACHER	Certificated	T02	05	P	A	1.00	43,157	1.00	32,713
EDN150/FA	7/27/2011	600784	SPEC ED TEACHER	Certificated	T02	05	T	A			1.00	32,713
EDN150/FA	7/27/2011	62546	SPEC ED TEACHER	Certificated	T02	05	P	A	1.00	66,359	1.00	32,713
EDN150/FA	7/27/2011	601074	GEN EDUC/ARTICLE VI TCHR	Certificated	T02	05	T	A			1.00	32,713
EDN150/FA	7/27/2011	60726	SPEC ED TEACHER	Certificated	T02	05	P	A	1.00	33,694	1.00	32,713
EDN100/AA	7/27/2011	66740	SECONDARY TEACHER	Certificated	T02	05	P	A	1.00	45,785	1.00	32,713
EDN150/FA	7/27/2011	31019	EDUCATIONAL ASSISTANT III	Y	SR10	03	P	A	1.00	31,769	1.00	33,756
EDN100/AA	7/27/2011	61597	LIBRARIAN	Certificated	T03	05	P	A	1.00	49,303	1.00	35,329
EDN100/BV	7/27/2011	61880	ELEM TEACHER	Certificated	T03	05	T	A	1.00	32,713	1.00	35,329
EDN150/FA	7/27/2011	600981	SPEC ED TEACHER	Certificated	T03	05	T	A			1.00	35,329
EDN100/AA	7/27/2011	600870	10-MONTH SAC TEACHER	Certificated	T03	05	T	A			1.00	35,329
EDN100/BJ	7/27/2011	61869	SPECIAL SCH TEACHER	Certificated	T03	05	T	A	1.00	37,481	1.00	37,481
EDN150/FA	7/27/2011	68235	SPEC ED TEACHER	Certificated	T02	05	P	A	1.00	40,567	1.00	40,567
EDN150/FA	7/27/2011	66324	SPEC ED TEACHER	Certificated	T02	05	P	A	1.00	40,567	1.00	40,567
EDN100/AA	7/27/2011	61347Z	ELEM TEACHER	Certificated	T02	05	P	A	1.00	43,157	1.00	40,567
EDN100/AA	7/27/2011	60866	SECONDARY TEACHER	Certificated	T02	05	P	A	1.00	49,448	1.00	40,567
EDN150/FA	7/27/2011	69083	SPEC ED TEACHER	Certificated	T02	05	P	A	1.00	40,567	1.00	40,567
EDN150/FA	7/27/2011	72429	SPEC ED TEACHER	Certificated	T02	05	P	A	1.00	40,567	1.00	40,567
EDN100/AA	7/27/2011	64392	ELEM TEACHER	Certificated	T02	05	P	A	1.00	44,202	1.00	40,567
EDN150/FA	7/27/2011	72489	SPEC ED TEACHER	Certificated	T02	05	P	A	1.00	40,567	1.00	40,567
EDN100/AA	7/27/2011	68703	SECONDARY TEACHER	Certificated	T02	05	T	A	1.00	40,567	1.00	40,567
EDN150/FA	7/27/2011	66749	SPEC ED TEACHER	Certificated	T02	05	P	A	1.00	40,567	1.00	40,567
EDN100/AA	7/27/2011	74204	SECONDARY TEACHER	Certificated	T02	05	P	A	1.00	40,567	1.00	40,567
EDN100/AA	7/27/2011	61000	ELEM TEACHER	Certificated	T02	05	P	A	1.00	45,747	1.00	40,567
EDN150/FA	7/27/2011	71014	SPEC ED TEACHER	Certificated	T02	05	P	A	1.00	43,157	1.00	40,567
EDN150/FA	7/27/2011	74676	SPEC ED TEACHER	Certificated	T02	05	P	A	1.00	40,567	1.00	40,567
EDN150/FA	7/27/2011	600043	SPEC ED TEACHER	Certificated	T02	05	T	A			1.00	40,567
EDN150/FA	7/27/2011	73738	SPEC ED TEACHER	Certificated	T02	05	P	A	1.00	40,567	1.00	40,567
EDN150/FA	7/27/2011	74101	SPEC ED TEACHER	Certificated	T02	05	P	A	1.00	49,448	1.00	40,567
EDN100/AA	7/27/2011	601296	SECONDARY TEACHER	Certificated	T02	05	T	A			1.00	40,567
EDN100/AA	7/27/2011	71128	ELEM TEACHER	Certificated	T02	05	P	A	1.00	51,925	1.00	40,567

Department of Education
Personnel Separations

Table 15

<u>Prog ID/Org</u>	<u>Separation Date</u>	<u>Position Number</u>	<u>Position Title</u>	<u>Exempt (Y/N)</u>	<u>SR Level</u>	<u>BU Code</u>	<u>T/P</u>	<u>MOF</u>	<u>Budgeted FTE</u>	<u>Budgeted Salary</u>	<u>Actual FTE</u>	<u>Actual Salary</u>
EDN100/AA	7/27/2011	65600	SECONDARY TEACHER	Certificated	T02	05	P	A	1.00	43,157	1.00	42,509
EDN100/AA	7/27/2011	63159	SECONDARY TEACHER	Certificated	T02	05	T	A	1.00	43,157	1.00	42,509
EDN100/AA	7/27/2011	65656	SECONDARY TEACHER	Certificated	T02	05	P	A	1.00	46,327	1.00	42,509
EDN150/FA	7/27/2011	68527	SPEC ED TEACHER	Certificated	T02	05	P	A	1.00	49,928	1.00	42,509
EDN100/AA	7/27/2011	600911	ELEM TEACHER	Certificated	T02	05	T	A			1.00	42,509
EDN100/AA	7/27/2011	600804	SECONDARY TEACHER	Certificated	T02	05	T	A			1.00	42,509
EDN150/FA	7/27/2011	75751	SPEC ED TEACHER	Certificated	T02	05	T	A	1.00	43,157	1.00	42,509
EDN100/AA	7/27/2011	63594	ELEM TEACHER	Certificated	T02	05	P	A	1.00	43,157	1.00	43,157
EDN150/FA	7/27/2011	72796	SPEC ED TEACHER	Certificated	T02	05	P	A	1.00	46,609	1.00	43,157
EDN100/AA	7/27/2011	61771	ELEM TEACHER	Certificated	T02	05	T	A	1.00	43,157	1.00	43,157
EDN100/AA	7/27/2011	76038	SECONDARY TEACHER	Certificated	T02	05	P	A	1.00	43,157	1.00	43,157
EDN100/AA	7/27/2011	76260	ELEM TEACHER	Certificated	T02	05	P	A	1.00	43,157	1.00	43,157
EDN150/FA	7/27/2011	75945	GEN EDUC/ARTICLE VI TCHR	Certificated	T02	05	P	A	1.00	43,157	1.00	43,157
EDN100/AA	7/27/2011	69076	SECONDARY TEACHER	Certificated	T02	05	P	A	1.00	46,609	1.00	43,157
EDN100/AA	7/27/2011	67395	SECONDARY TEACHER	Certificated	T02	05	P	A	1.00	43,812	1.00	43,157
EDN100/AA	7/27/2011	63924	ELEM TEACHER	Certificated	T02	05	P	A	1.00	79,170	1.00	43,157
EDN100/AA	7/27/2011	600799	ELEM TEACHER	Certificated	T02	05	T	A			1.00	43,157
EDN150/FA	7/27/2011	600384	SPEC ED TEACHER	Certificated	T02	05	T	A			1.00	43,157
EDN150/FA	7/27/2011	600535	SPEC ED TEACHER	Certificated	T02	05	T	A			1.00	43,157
EDN150/FA	7/27/2011	63087	GEN EDUC/ARTICLE VI TCHR	Certificated	T02	05	P	A	1.00	49,448	1.00	43,157
EDN150/FA	7/27/2011	64279	SPEC ED TEACHER	Certificated	T02	05	P	A	1.00	46,609	1.00	43,157
EDN100/AA	7/27/2011	600627	SECONDARY TEACHER	Certificated	T02	05	T	A			1.00	43,157
EDN100/AA	7/27/2011	65763	ELEM TEACHER	Certificated	T02	05	T	A	1.00	60,004	1.00	43,157
EDN100/AA	7/27/2011	65697	ELEM TEACHER	Certificated	T02	05	P	A	1.00	48,008	1.00	43,157
EDN100/AA	7/27/2011	600853	ELEM TEACHER	Certificated	T02	05	T	A			1.00	43,157
EDN150/FA	7/27/2011	72263	SPEC ED TEACHER	Certificated	T02	05	P	A	1.00	55,087	1.00	43,157
EDN150/FA	7/27/2011	600209	SPEC ED TCHR/PRE-SCHOOL	Certificated	T02	05	T	A			1.00	43,157
EDN150/FA	7/27/2011	67310	SPEC ED TEACHER	Certificated	T02	05	P	A	1.00	43,157	1.00	43,157
EDN100/AA	7/27/2011	600969	ELEM TEACHER	Certificated	T02	05	T	A			1.00	43,157
EDN100/AA	7/27/2011	67994	ELEM TEACHER	Certificated	T02	05	P	A	1.00	43,157	1.00	43,157
EDN150/FA	7/27/2011	72812	SPEC ED TEACHER	Certificated	T02	05	P	A	1.00	32,713	1.00	43,157
EDN100/AA	7/27/2011	71950	ELEM TEACHER	Certificated	T02	05	T	A	1.00	43,157	1.00	43,157
EDN100/AA	7/27/2011	60882	ELEM TEACHER	Certificated	T02	05	P	A	1.00	43,157	1.00	43,157
EDN150/FA	7/27/2011	601068	SPEC ED TEACHER	Certificated	T02	05	T	A			1.00	43,157
EDN150/FA	7/27/2011	75600	GEN EDUC/ARTICLE VI TCHR	Certificated	T02	05	P	A	1.00	43,157	1.00	43,157
EDN150/FA	7/27/2011	65437	GEN EDUC/ARTICLE VI TCHR	Certificated	T02	05	P	A	1.00	47,654	1.00	43,157
EDN100/AA	7/27/2011	61310	ELEM TEACHER	Certificated	T02	05	P	A	1.00	46,830	1.00	43,157
EDN100/AA	7/27/2011	600851	ELEM TEACHER	Certificated	T02	05	T	A			1.00	43,157
EDN100/AA	7/27/2011	60635	ELEM TEACHER	Certificated	T02	05	P	A	1.00	52,970	1.00	43,157
EDN150/FA	7/27/2011	63211	GEN EDUC/ARTICLE VI TCHR	Certificated	T02	05	P	A	1.00	68,351	1.00	43,157
EDN150/FA	7/27/2011	600173	SPEC ED TEACHER	Certificated	T02	05	T	A			1.00	43,157
EDN100/AA	7/27/2011	601157	SPEC ED TEACHER	Certificated	T02	05	T	A			1.00	43,157
EDN150/FA	7/27/2011	69868	SPEC ED TEACHER	Certificated	T02	05	P	A	1.00	43,157	1.00	43,157
EDN100/AA	7/27/2011	69729	SECONDARY TEACHER	Certificated	T02	05	P	A	1.00	43,157	1.00	43,157
EDN150/FA	7/27/2011	75725	SPEC ED TEACHER	Certificated	T02	05	P	A	1.00	46,609	1.00	43,157

<u>Prog ID/Org</u>	<u>Separation Date</u>	<u>Position Number</u>	<u>Position Title</u>	<u>Exempt (Y/N)</u>	<u>SR Level</u>	<u>BU Code</u>	<u>T/P</u>	<u>MOF</u>	<u>Budgeted FTE</u>	<u>Budgeted Salary</u>	<u>Actual FTE</u>	<u>Actual Salary</u>
EDN150/FA	7/27/2011	72762	SPEC ED TEACHER	Certificated	T02	05	P	A	1.00	46,609	1.00	43,157
EDN150/FA	7/27/2011	75515	SPEC ED TCHR/PRE-SCHOOL	Certificated	T02	05	T	A	1.00	43,157	1.00	43,157
EDN150/FA	7/27/2011	73256	SPEC ED TEACHER	Certificated	T02	05	T	A	1.00	43,157	1.00	43,157
EDN150/FA	7/27/2011	76330	SPEC ED TEACHER	Certificated	T02	05	P	A	1.00	43,157	1.00	43,157
EDN150/FA	7/27/2011	73680	SPEC ED TEACHER	Certificated	T02	05	P	A	1.00	52,460	1.00	43,157
EDN150/FA	7/27/2011	74333	SPEC ED TEACHER	Certificated	T02	05	P	A	1.00	43,157	1.00	43,157
EDN150/FA	7/27/2011	72043	SPEC ED TEACHER	Certificated	T02	05	P	A	1.00	43,157	1.00	43,157
EDN100/AA	7/27/2011	65663	ELEM TEACHER	Certificated	T02	05	P	A	1.00	43,157	1.00	43,157
EDN150/FA	7/27/2011	600159	SPEC ED TEACHER	Certificated	T02	05	T	A			1.00	43,157
EDN150/FA	7/27/2011	601816	GEN EDUC/ARTICLE VI TCHR	Certificated	T02	05	T	A			1.00	43,157
EDN100/AA	7/27/2011	67101	ELEM TEACHER	Certificated	T02	05	P	A	1.00	45,785	1.00	43,157
EDN100/AA	7/27/2011	600687	ELEM TEACHER	Certificated	T02	05	T	A			1.00	43,157
EDN100/AA	7/27/2011	73195	SECONDARY TEACHER	Certificated	T02	05	P	A	1.00	49,448	1.00	43,157
EDN150/FA	7/27/2011	63920	SPEC ED TCHR/PRE-SCHOOL	Certificated	T02	05	P	A	1.00	43,157	1.00	43,157
EDN100/AA	7/27/2011	61937	SECONDARY TEACHER	Certificated	T02	05	P	A	1.00	56,740	1.00	43,157
EDN100/AA	7/27/2011	74502	SECONDARY TEACHER	Certificated	T02	05	P	A	1.00	49,448	1.00	43,157
EDN100/AA	7/27/2011	600910	ELEM TEACHER	Certificated	T02	05	T	A			1.00	43,157
EDN150/FA	7/27/2011	62145	SPEC ED TEACHER	Certificated	T02	05	P	A	1.00	51,426	1.00	43,157
EDN150/FA	7/27/2011	69312	SPEC ED TEACHER	Certificated	T02	05	P	A	1.00	43,157	1.00	43,157
EDN150/FA	7/27/2011	72640	SPEC ED TEACHER	Certificated	T02	05	P	A	1.00	43,157	1.00	43,157
EDN150/FA	7/27/2011	71217	SPEC ED TEACHER	Certificated	T02	05	P	A	1.00	43,157	1.00	43,157
EDN150/FA	7/27/2011	74759	SPEC ED TEACHER	Certificated	T02	05	P	A	1.00	64,427	1.00	43,157
EDN100/AA	7/27/2011	600104	ELEM TEACHER	Certificated	T02	05	T	A			1.00	43,157
EDN150/FA	7/27/2011	67250	SPEC ED TEACHER	Certificated	T02	05	T	A	1.00	43,157	1.00	43,157
EDN150/FA	7/27/2011	72228	SPEC ED TEACHER	Certificated	T02	05	P	A	1.00	45,785	1.00	43,157
EDN100/AA	7/27/2011	67366	SECONDARY TEACHER	Certificated	T02	05	P	A	1.00	63,595	1.00	43,157
EDN100/BJ	7/27/2011	73045	SPECIAL SCH TEACHER	Certificated	T02	05	P	A	1.00	43,157	1.00	43,157
EDN100/AA	7/27/2011	67785X	ELEM TEACHER	Certificated	T02	05	T	A	1.00	43,157	1.00	43,157
EDN100/AA	7/27/2011	69115	SECONDARY TEACHER	Certificated	T02	05	P	A	1.00	46,609	1.00	43,785
EDN100/AA	7/27/2011	69969	SECONDARY TEACHER	Certificated	T02	05	P	A	1.00	44,452	1.00	43,785
EDN100/AA	7/27/2011	74149	SECONDARY TEACHER	Certificated	T02	05	T	A	1.00	44,452	1.00	43,785
EDN100/AA	7/27/2011	61092	ELEM TEACHER	Certificated	T02	05	P	A	1.00	43,157	1.00	43,785
EDN100/AA	7/27/2011	66701	SECONDARY TEACHER	Certificated	T02	05	P	A	1.00	60,004	1.00	44,452
EDN150/FA	7/27/2011	69946	SPEC ED TEACHER	Certificated	T02	05	P	A	1.00	44,452	1.00	44,452
EDN100/AA	7/27/2011	63066	ELEM TEACHER	Certificated	T02	05	P	A			1.00	44,452
EDN100/AA	7/27/2011	68192	ELEM TEACHER	Certificated	T02	05	P	A	1.00	43,157	1.00	44,452
EDN100/AA	7/27/2011	69627	ELEM TEACHER	Certificated	T02	05	T	A	1.00	44,452	1.00	44,452
EDN150/FA	7/27/2011	68084	SPEC ED TEACHER	Certificated	T02	05	P	A	1.00	44,452	1.00	44,452
EDN150/FA	7/27/2011	74843	GEN EDUC/ARTICLE VI TCHR	Certificated	T02	05	P	A	1.00	44,452	1.00	44,452
EDN150/FA	7/27/2011	68271	SPEC ED TEACHER	Certificated	T02	05	P	A	1.00	44,452	1.00	44,452
EDN150/FA	7/27/2011	68398	SPEC ED TEACHER	Certificated	T02	05	P	A	1.00	44,452	1.00	44,452
EDN150/FA	7/27/2011	76131	GEN EDUC/ARTICLE VI TCHR	Certificated	T02	05	P	A	1.00	44,452	1.00	44,452
EDN150/FA	7/27/2011	75853	SPEC ED TEACHER	Certificated	T02	05	P	A	1.00	32,713	1.00	44,452
EDN150/FA	7/27/2011	62269	SPEC ED TCHR/PRE-SCHOOL	Certificated	T02	05	P	A	1.00	45,785	1.00	45,785
EDN100/AA	7/27/2011	66861	SECONDARY TEACHER	Certificated	T02	05	P	A	1.00	45,785	1.00	45,785

<u>Prog ID/Org</u>	<u>Separation Date</u>	<u>Position Number</u>	<u>Position Title</u>	<u>Exempt (Y/N)</u>	<u>SR Level</u>	<u>BU Code</u>	<u>T/P</u>	<u>MOF</u>	<u>Budgeted FTE</u>	<u>Budgeted Salary</u>	<u>Actual FTE</u>	<u>Actual Salary</u>
EDN100/AA	7/27/2011	64016	ELEM TEACHER	Certificated	T02	05	P	A	1.00	53,483	1.00	45,785
EDN150/FA	7/27/2011	76028	SPEC ED TEACHER	Certificated	T02	05	T	A	1.00	50,785	1.00	45,785
EDN100/AA	7/27/2011	64024	ELEM TEACHER	Certificated	T02	05	P	A	1.00	43,157	1.00	45,785
EDN150/FA	7/27/2011	63088	GEN EDUC/ARTICLE VI TCHR	Certificated	T02	05	P	A	1.00	46,830	1.00	45,785
EDN100/AA	7/27/2011	61310	ELEM TEACHER	Certificated	T02	05	P	A	1.00	46,830	1.00	45,785
EDN150/FA	7/27/2011	65279	GEN EDUC/ARTICLE VI TCHR	Certificated	T02	05	P	A	1.00	45,785	1.00	45,785
EDN100/AA	7/27/2011	63765	COUNSELOR	Certificated	T02	05	P	A	1.00	45,785	1.00	45,785
EDN100/BV	7/27/2011	74846	SECONDARY TEACHER	Certificated	T03	05	T	A	1.00	46,609	1.00	45,909
EDN150/FA	7/27/2011	75922	GEN EDUC/ARTICLE VI TCHR	Certificated	T03	05	P	A	1.00	45,785	1.00	45,909
EDN150/FA	7/27/2011	601137	SPEC ED TCHR/PRE-SCHOOL	Certificated	T03	05	T	A			1.00	45,909
EDN100/AA	7/27/2011	74836	ELEM TEACHER	Certificated	T03	05	P	A	1.00	53,008	1.00	45,909
EDN100/AA	7/27/2011	69010	GEN EDUC/ARTICLE VI TCHR	Certificated	T03	05	P	A	1.00	43,157	1.00	45,909
EDN100/AA	7/27/2011	600813	SPEC ED TEACHER	Certificated	T03	05	T	A			1.00	45,909
EDN100/AA	7/27/2011	62405	ELEM TEACHER	Certificated	T03	05	P	A	1.00	54,528	1.00	45,909
EDN150/FA	7/27/2011	63733	SPEC ED TEACHER	Certificated	T03	05	T	A	1.00	46,609	1.00	45,909
EDN150/FA	7/27/2011	73308	SPEC ED TEACHER	Certificated	T03	05	P	A	1.00	46,609	1.00	45,909
EDN150/FA	7/27/2011	65943	GEN EDUC/ARTICLE VI TCHR	Certificated	T03	05	P	A	1.00	46,609	1.00	45,909
EDN100/AA	7/27/2011	601081	SPEC ED TEACHER	Certificated	T03	05	T	A			1.00	45,909
EDN100/AA	7/27/2011	64528	SECONDARY TEACHER	Certificated	T03	05	P	A	1.00	43,157	1.00	45,909
EDN100/AA	7/27/2011	66560	ELEM TEACHER	Certificated	T03	05	P	A	1.00	63,595	1.00	46,609
EDN100/AA	7/27/2011	600638	SECONDARY TEACHER	Certificated	T03	05	T	A			1.00	46,609
EDN150/FA	7/27/2011	73220	SPEC ED TEACHER	Certificated	T03	05	P	A	1.00	43,157	1.00	46,609
EDN100/AA	7/27/2011	62760	ELEM TEACHER	Certificated	T03	05	P	A	1.00	43,157	1.00	46,609
EDN150/FA	7/27/2011	601071	GEN EDUC/ARTICLE VI TCHR	Certificated	T03	05	T	A			1.00	46,609
EDN100/AA	7/27/2011	60690	SECONDARY TEACHER	Certificated	T03	05	P	A	1.00	46,609	1.00	46,609
EDN100/AA	7/27/2011	69327	SECONDARY TEACHER	Certificated	T03	05	P	A	1.00	46,609	1.00	46,609
EDN100/DB	7/27/2011	79413	ELEM TEACHER	Certificated	T03	05	T	N			1.00	46,609
EDN100/AA	7/27/2011	65987	ELEM TEACHER	Certificated	T03	05	P	A	1.00	49,448	1.00	46,609
EDN100/AA	7/27/2011	66864	SECONDARY TEACHER	Certificated	T03	05	P	A	1.00	46,609	1.00	46,609
EDN100/AA	7/27/2011	61340	SECONDARY TEACHER	Certificated	T03	05	P	A	1.00	63,959	1.00	46,609
EDN100/AA	7/27/2011	68788	SECONDARY TEACHER	Certificated	T03	05	P	A	1.00	53,483	1.00	46,609
EDN150/FA	7/27/2011	65187	GEN EDUC/ARTICLE VI TCHR	Certificated	T03	05	P	A	1.00	40,567	1.00	46,609
EDN100/AA	7/27/2011	72175	SECONDARY TEACHER	Certificated	T03	05	P	A	1.00	46,609	1.00	46,609
EDN150/FA	7/27/2011	75653	SPEC ED TEACHER	Certificated	T03	05	T	A	1.00	46,609	1.00	46,609
EDN150/FA	7/27/2011	75921	GEN EDUC/ARTICLE VI TCHR	Certificated	T03	05	P	A	1.00	40,567	1.00	46,609
EDN100/AA	7/27/2011	73972	ELEM TEACHER	Certificated	T03	05	T	A	1.00	46,609	1.00	46,609
EDN100/DB	7/27/2011	79710	SECONDARY TEACHER	Certificated	T03	05	T	N			1.00	46,609
EDN100/BB	7/27/2011	75819	SECONDARY TEACHER	Certificated	T03	05	P	A	1.00	48,008	1.00	46,609
EDN100/AA	7/27/2011	61063	ELEM TEACHER	Certificated	T03	05	P	A	1.00	46,609	1.00	46,609
EDN100/AA	7/27/2011	600865	ELEM TEACHER	Certificated	T03	05	T	A			1.00	46,609
EDN150/FB	7/27/2011	75794	SPEC ED TEACHER	Certificated	T03	05	P	A	1.00	46,609	1.00	46,609
EDN150/FA	7/27/2011	71354	SPEC ED TEACHER	Certificated	T03	05	P	A	1.00	52,460	1.00	46,609
EDN100/AA	7/27/2011	73741	SECONDARY TEACHER	Certificated	T03	05	P	A	1.00	32,713	1.00	46,609
EDN100/AA	7/27/2011	62420	ELEM TEACHER	Certificated	T03	05	P	A	1.00	43,157	1.00	46,609
EDN100/AA	7/27/2011	61589	ELEM TEACHER	Certificated	T03	05	P	A	1.00	68,408	1.00	46,609

<u>Prog ID/Org</u>	<u>Separation Date</u>	<u>Position Number</u>	<u>Position Title</u>	<u>Exempt (Y/N)</u>	<u>SR Level</u>	<u>BU Code</u>	<u>T/P</u>	<u>MOF</u>	<u>Budgeted FTE</u>	<u>Budgeted Salary</u>	<u>Actual FTE</u>	<u>Actual Salary</u>
EDN100/AA	7/27/2011	65885	SECONDARY TEACHER	Certificated	T03	05	P	A	1.00	40,567	1.00	46,609
EDN150/FA	7/27/2011	61974	SPEC ED TEACHER	Certificated	T03	05	P	A	1.00	32,713	1.00	46,609
EDN150/FA	7/27/2011	64442	SPEC ED TCHR/PRE-SCHOOL	Certificated	T03	05	P	A	1.00	43,157	1.00	46,609
EDN100/AA	7/27/2011	600434	ELEM TEACHER	Certificated	T03	05	T	A			1.00	46,609
EDN150/FA	7/27/2011	63496	GEN EDUC/ARTICLE VI TCHR	Certificated	T03	05	P	A	1.00	40,567	1.00	46,609
EDN100/AA	7/27/2011	69389	SECONDARY TEACHER	Certificated	T03	05	T	A	1.00	46,609	1.00	46,609
EDN100/AA	7/27/2011	74838	SECONDARY TEACHER	Certificated	T03	05	T	A	1.00	66,359	1.00	46,609
EDN100/AA	7/27/2011	600822	ELEM TEACHER	Certificated	T03	05	T	A			1.00	46,609
EDN150/FA	7/27/2011	75848	SPEC ED TEACHER	Certificated	T03	05	T	A	1.00	43,157	1.00	46,609
EDN100/AA	7/27/2011	68893	SECONDARY TEACHER	Certificated	T03	05	P	A	1.00	46,609	1.00	46,609
EDN100/AA	7/27/2011	71646	ELEM TEACHER	Certificated	T03	05	P	A	1.00	71,445	1.00	46,609
EDN100/AA	7/27/2011	600733	SECONDARY TEACHER	Certificated	T03	05	T	A			1.00	46,609
EDN100/DB	7/27/2011	79665	SECONDARY TEACHER	Certificated	T03	05	T	N			1.00	46,609
EDN150/FA	7/27/2011	75563	SPEC ED TCHR/PRE-SCHOOL	Certificated	T03	05	T	A	1.00	46,609	1.00	46,609
EDN100/AA	7/27/2011	600644	ELEM TEACHER	Certificated	T03	05	T	A			1.00	46,609
EDN150/FA	7/27/2011	73891	SPEC ED TCHR/PRE-SCHOOL	Certificated	T03	05	P	A	1.00	46,609	1.00	46,609
EDN100/AA	7/27/2011	68502	ELEM TEACHER	Certificated	T03	05	P	A	1.00	46,609	1.00	46,609
EDN150/FA	7/27/2011	600157	SPEC ED TEACHER	Certificated	T03	05	T	A			1.00	46,609
EDN100/AA	7/27/2011	71368	COUNSELOR	Certificated	T03	05	T	A	1.00	32,713	1.00	46,609
EDN100/AA	7/27/2011	62616	ELEM TEACHER	Certificated	T03	05	P	A	1.00	54,528	1.00	46,609
EDN150/FA	7/27/2011	73225	SPEC ED TEACHER	Certificated	T03	05	P	A	1.00	46,609	1.00	46,609
EDN150/FA	7/27/2011	74181	SPEC ED TEACHER	Certificated	T03	05	P	A	1.00	46,609	1.00	46,609
EDN150/FA	7/27/2011	75929	GEN EDUC/ARTICLE VI TCHR	Certificated	T03	05	P	A	1.00	40,567	1.00	46,609
EDN150/FA	7/27/2011	600366	SPEC ED TEACHER	Certificated	T03	05	T	A			1.00	46,609
EDN150/FA	7/27/2011	69138	GEN EDUC/ARTICLE VI TCHR	Certificated	T03	05	P	A	1.00	46,609	1.00	46,609
EDN100/AA	7/27/2011	65321	SECONDARY TEACHER	Certificated	T03	05	P	A	1.00	43,157	1.00	46,609
EDN100/AA	7/27/2011	61872	ELEM TEACHER	Certificated	T03	05	P	A	1.00	43,157	1.00	46,609
EDN100/AA	7/27/2011	72169	SECONDARY TEACHER	Certificated	T03	05	P	A	1.00	48,008	1.00	46,609
EDN150/FA	7/27/2011	62110	SPEC ED TEACHER	Certificated	T03	05	P	A	1.00	32,713	1.00	46,609
EDN100/AA	7/27/2011	63315	ELEM TEACHER	Certificated	T03	05	P	A	1.00	49,448	1.00	46,609
EDN100/AA	7/27/2011	66046	SECONDARY TEACHER	Certificated	T03	05	P	A	1.00	49,448	1.00	46,609
EDN150/FA	7/27/2011	74762	SPEC ED TEACHER	Certificated	T03	05	P	A	1.00	51,426	1.00	46,609
EDN100/AA	7/27/2011	66523	SECONDARY TEACHER	Certificated	T03	05	P	A	1.00	40,567	1.00	46,609
EDN150/FB	7/27/2011	60267	SPECIAL SCH TEACHER	Certificated	T03	05	P	A	1.00	35,329	1.00	46,609
EDN150/FA	7/27/2011	65988	SPEC ED TEACHER	Certificated	T03	05	P	A	1.00	32,713	1.00	46,609
EDN100/AA	7/27/2011	73887	SECONDARY TEACHER	Certificated	T03	05	P	A	1.00	51,925	1.00	46,609
EDN100/AA	7/27/2011	69856	ELEM TEACHER	Certificated	T03	05	P	A	1.00	54,558	1.00	46,609
EDN100/AA	7/27/2011	67078	ELEM TEACHER	Certificated	T03	05	P	A	1.00	61,405	1.00	46,609
EDN150/FA	7/27/2011	600590	SPEC ED TEACHER	Certificated	T03	05	T	A			1.00	46,609
EDN150/FA	7/27/2011	73550	GEN EDUC/ARTICLE VI TCHR	Certificated	T02	05	T	A	1.00	47,159	1.00	47,159
EDN100/AA	7/27/2011	62191	SECONDARY TEACHER	Certificated	T03	05	P	A	1.00	58,959	1.00	47,287
EDN100/AA	7/27/2011	600800	ELEM TEACHER	Certificated	T03	05	T	A			1.00	47,287
EDN150/FA	7/27/2011	600437	SPEC ED TEACHER	Certificated	T03	05	T	A			1.00	47,287
EDN100/AA	7/27/2011	65708	COUNSELOR	Certificated	T03	05	P	A	1.00	79,170	1.00	47,287
EDN100/AA	7/27/2011	68353	ELEM TEACHER	Certificated	T03	05	T	A	1.00	48,008	1.00	47,287

<u>Prog ID/Org</u>	<u>Separation Date</u>	<u>Position Number</u>	<u>Position Title</u>	<u>Exempt (Y/N)</u>	<u>SR Level</u>	<u>BU Code</u>	<u>T/P</u>	<u>MOF</u>	<u>Budgeted FTE</u>	<u>Budgeted Salary</u>	<u>Actual FTE</u>	<u>Actual Salary</u>
EDN100/AA	7/27/2011	64646	ELEM TEACHER	Certificated	T04	05	T	A	1.00	46,609	1.00	47,746
EDN150/FA	7/27/2011	64411	GEN EDUC/ARTICLE VI TCHR	Certificated	T03	05	P	A	1.00	43,157	1.00	48,008
EDN150/FA	7/27/2011	65160	SPEC ED TEACHER	Certificated	T03	05	P	A	1.00	43,157	1.00	48,008
EDN150/FA	7/27/2011	76329	SPEC ED TCHR/PRE-SCHOOL	Certificated	T03	05	P	A	1.00	44,452	1.00	48,008
EDN100/AA	7/27/2011	69358	SECONDARY TEACHER	Certificated	T03	05	T	A	1.00	49,053	1.00	48,008
EDN100/AA	7/27/2011	69884	ELEM TEACHER	Certificated	T03	05	P	A	1.00	48,008	1.00	48,008
EDN150/FA	7/27/2011	67029	GEN EDUC/ARTICLE VI TCHR	Certificated	T03	05	P	A	1.00	40,567	1.00	48,008
EDN100/AA	7/27/2011	61795	SECONDARY TEACHER	Certificated	T03	05	P	A	1.00	49,053	1.00	48,008
EDN100/AA	7/27/2011	74836	ELEM TEACHER	Certificated	T03	05	P	A	1.00	53,008	1.00	48,008
EDN150/FA	7/27/2011	75899	GEN EDUC/ARTICLE VI TCHR	Certificated	T03	05	P	A	1.00	48,008	1.00	48,008
EDN150/FA	7/27/2011	73369	SPEC ED TEACHER	Certificated	T03	05	P	A	1.00	48,008	1.00	48,008
EDN100/AA	7/27/2011	68898	SECONDARY TEACHER	Certificated	T03	05	P	A	1.00	48,008	1.00	48,008
EDN100/AA	7/27/2011	68981	SECONDARY TEACHER	Certificated	T03	05	P	A	1.00	48,008	1.00	48,008
EDN150/FA	7/27/2011	72305	SPEC ED TEACHER	Certificated	T03	05	T	A	1.00	48,008	1.00	48,008
EDN150/FA	7/27/2011	600741	SPEC ED TEACHER	Certificated	T03	05	T	A			1.00	48,008
EDN150/FA	7/27/2011	67549	SPEC ED TEACHER	Certificated	T03	05	P	A	1.00	48,008	1.00	48,008
EDN150/FA	7/27/2011	67262	SPEC ED TEACHER	Certificated	T03	05	P	A	1.00	48,008	1.00	48,008
EDN100/AA	7/27/2011	65659	SECONDARY TEACHER	Certificated	T03	05	P	A	1.00	48,008	1.00	48,008
EDN150/FA	7/27/2011	60737	SPEC ED TEACHER	Certificated	T03	05	P	A			1.00	48,008
EDN200/GN	7/27/2011	600915	COMPLEX AREA TEACHER	Certificated	T03	05	T	A			1.00	48,008
EDN100/AA	7/27/2011	62931	ELEM TEACHER	Certificated	T03	05	P	A	1.00	52,968	1.00	48,008
EDN100/AA	7/27/2011	600707	ELEM TEACHER	Certificated	T03	05	T	A			1.00	48,008
EDN100/AA	7/27/2011	67266	SECONDARY TEACHER	Certificated	T03	05	P	A	1.00	48,008	1.00	48,008
EDN100/AA	7/27/2011	74277	SECONDARY TEACHER	Certificated	T03	05	P	A	1.00	58,959	1.00	48,008
EDN150/FA	7/27/2011	66643	SPEC ED TEACHER	Certificated	T03	05	P	A	1.00	48,008	1.00	48,008
EDN100/AA	7/27/2011	600637	ELEM TEACHER	Certificated	T03	05	T	A			1.00	48,008
EDN150/FA	7/27/2011	67812	SPEC ED TEACHER	Certificated	T03	05	P	A	1.00	46,609	1.00	48,008
EDN150/FA	7/27/2011	71630	SPEC ED TEACHER	Certificated	T03	05	P	A			1.00	48,008
EDN150/FA	7/27/2011	75902	GEN EDUC/ARTICLE VI TCHR	Certificated	T03	05	P	A	1.00	51,758	1.00	48,008
EDN100/AA	7/27/2011	63773	SECONDARY TEACHER	Certificated	T03	05	P	A	1.00	32,713	1.00	48,008
EDN100/AA	7/27/2011	68675	SECONDARY TEACHER	Certificated	T03	05	T	A	1.00	48,008	1.00	48,008
EDN150/FA	7/27/2011	63042	SPEC ED TEACHER	Certificated	T03	05	T	A	1.00	43,157	1.00	48,008
EDN150/FA	7/27/2011	60382	SPEC ED TEACHER	Certificated	T03	05	T	A	1.00	48,008	1.00	48,008
EDN150/FA	7/27/2011	64329	SPEC ED TEACHER	Certificated	T03	05	P	A	1.00	32,713	1.00	48,008
EDN100/AA	7/27/2011	61524	ELEM TEACHER	Certificated	T03	05	P	A	1.00	45,785	1.00	48,008
EDN150/FA	7/27/2011	65971	SPEC ED TEACHER	Certificated	T03	05	P	A	1.00	48,008	1.00	48,008
EDN150/FA	7/27/2011	65975	SPEC ED TEACHER	Certificated	T03	05	P	A	1.00	50,743	1.00	48,008
EDN100/AA	7/27/2011	67775	ELEM TEACHER	Certificated	T03	05	P	A	1.00	48,008	1.00	48,008
EDN100/AA	7/27/2011	73374	COUNSELOR	Certificated	T03	05	P	A	1.00	53,483	1.00	48,008
EDN100/AA	7/27/2011	66155	SECONDARY TEACHER	Certificated	T03	05	P	A	1.00	48,008	1.00	48,008
EDN100/AA	7/27/2011	68899	SECONDARY TEACHER	Certificated	T03	05	P	A	1.00	52,471	1.00	48,008
EDN150/FB	7/27/2011	75795	SPEC ED TEACHER	Certificated	T03	05	P	A	1.00	46,609	1.00	48,008
EDN100/AA	7/27/2011	62035	SECONDARY TEACHER	Certificated	T03	05	P	A	1.00	49,448	1.00	48,008
EDN100/AA	7/27/2011	68986	SECONDARY TEACHER	Certificated	T03	05	P	A	1.00	44,452	1.00	48,008
EDN150/FA	7/27/2011	62446	GEN EDUC/ARTICLE VI TCHR	Certificated	T03	05	T	A	1.00	50,931	1.00	48,008

Department of Education
Personnel Separations

Table 15

<u>Prog ID/Org</u>	<u>Separation Date</u>	<u>Position Number</u>	<u>Position Title</u>	<u>Exempt (Y/N)</u>	<u>SR Level</u>	<u>BU Code</u>	<u>T/P</u>	<u>MOF</u>	<u>Budgeted FTE</u>	<u>Budgeted Salary</u>	<u>Actual FTE</u>	<u>Actual Salary</u>
EDN150/FA	7/27/2011	75686	SPEC ED TEACHER	Certificated	T03	05	T	A	1.00	48,008	1.00	48,008
EDN100/AA	7/27/2011	600219	SECONDARY TEACHER	Certificated	T04	05	T	A			1.00	48,474
EDN150/FA	7/27/2011	75513	SPEC ED TCHR/PRE-SCHOOL	Certificated	T04	05	T	A	1.00	43,157	1.00	48,474
EDN100/AA	7/27/2011	75029	SECONDARY TEACHER	Certificated	T03	05	P	A	1.00	53,198	1.00	48,706
EDN150/FA	7/27/2011	63222	SPEC ED TEACHER	Certificated	T03	05	P	A	1.00	45,785	1.00	49,448
EDN100/AA	7/27/2011	61133	ELEM TEACHER	Certificated	T03	05	T	A	1.00	49,448	1.00	49,448
EDN150/FA	7/27/2011	75757	GEN EDUC/ARTICLE VI TCHR	Certificated	T03	05	T	A	1.00	49,448	1.00	49,448
EDN150/FA	7/27/2011	63284	SPEC ED TCHR/PRE-SCHOOL	Certificated	T03	05	P	A	1.00	49,448	1.00	49,448
EDN100/AA	7/27/2011	60569	ELEM TEACHER	Certificated	T03	05	T	A	1.00	49,448	1.00	49,448
EDN150/FA	7/27/2011	68083	SPEC ED TEACHER	Certificated	T03	05	P	A	1.00	43,157	1.00	49,448
EDN100/AA	7/27/2011	600446	SECONDARY TEACHER	Certificated	T03	05	T	A			1.00	49,448
EDN100/AA	7/27/2011	68740	SECONDARY TEACHER	Certificated	T03	05	T	A			1.00	49,448
EDN150/FA	7/27/2011	74182	SPEC ED TEACHER	Certificated	T03	05	P	A	1.00	49,448	1.00	49,448
EDN100/AA	7/27/2011	74232	SECONDARY TEACHER	Certificated	T03	05	T	A	0.50	24,004	1.00	49,448
EDN150/FA	7/27/2011	75538	GEN EDUC/ARTICLE VI TCHR	Certificated	T03	05	T	A	1.00	43,157	1.00	49,448
EDN100/AA	7/27/2011	63017	SECONDARY TEACHER	Certificated	T03	05	P	A	1.00	49,448	1.00	49,448
EDN150/FA	7/27/2011	65101	SPEC ED TEACHER	Certificated	T03	05	P	A	1.00	45,785	1.00	49,448
EDN150/FA	7/27/2011	73308	SPEC ED TEACHER	Certificated	T03	05	P	A	1.00	46,609	1.00	49,448
EDN100/AA	7/27/2011	68175	SECONDARY TEACHER	Certificated	T03	05	P	A	1.00	49,448	1.00	49,448
EDN100/AA	7/27/2011	67892	ELEM TEACHER	Certificated	T03	05	P	A	1.00	59,010	1.00	49,448
EDN150/FA	7/27/2011	67970	SPEC ED TEACHER	Certificated	T03	05	P	A	1.00	49,448	1.00	49,448
EDN100/AA	7/27/2011	69316	ELEM TEACHER	Certificated	T03	05	P	A	1.00	62,550	1.00	49,448
EDN150/FA	7/27/2011	74107	SPEC ED TCHR/PRE-SCHOOL	Certificated	T03	05	P	A			1.00	49,448
EDN150/FA	7/27/2011	66613	SPEC ED TEACHER	Certificated	T03	05	P	A	1.00	48,474	1.00	49,448
EDN100/AA	7/27/2011	61445	ELEM TEACHER	Certificated	T03	05	T	A	1.00	49,448	1.00	49,448
EDN150/FA	7/27/2011	75893	GEN EDUC/ARTICLE VI TCHR	Certificated	T03	05	P	A	1.00	49,448	1.00	49,448
EDN100/AA	7/27/2011	72029	SECONDARY TEACHER	Certificated	T03	05	P	A	1.00	43,157	1.00	49,448
EDN100/AA	7/27/2011	73153	COUNSELOR	Certificated	T03	05	P	A	1.00	49,448	1.00	49,448
EDN100/AA	7/27/2011	68759	ELEM TEACHER	Certificated	T04	05	P	A			1.00	49,448
EDN100/AA	7/27/2011	62184	SECONDARY TEACHER	Certificated	T03	05	T	A	1.00	43,157	1.00	49,448
EDN150/FA	7/27/2011	73187	SPEC ED TEACHER	Certificated	T03	05	P	A	1.00	61,774	1.00	49,448
EDN150/FA	7/27/2011	66038	GEN EDUC/ARTICLE VI TCHR	Certificated	T03	05	P	A	1.00	49,448	1.00	49,448
EDN100/AA	7/27/2011	66866	SECONDARY TEACHER	Certificated	T03	05	P	A	1.00	54,448	1.00	49,448
EDN150/FA	7/27/2011	66915	SPEC ED TEACHER	Certificated	T03	05	P	A	1.00	48,008	1.00	49,448
EDN100/AA	7/27/2011	65470	SECONDARY TEACHER	Certificated	T03	05	P	A	1.00	49,448	1.00	49,448
EDN150/FA	7/27/2011	75527	SPEC ED TCHR/PRE-SCHOOL	Certificated	T03	05	P	A	1.00	49,448	1.00	49,448
EDN100/AA	7/27/2011	65092	ELEM TEACHER	Certificated	T03	05	P	A	1.00	50,493	1.00	49,448
EDN100/AA	7/27/2011	66004	ELEM TEACHER	Certificated	T03	05	P	A	1.00	58,959	1.00	49,448
EDN100/AA	7/27/2011	67020	SECONDARY TEACHER	Certificated	T03	05	P	A	1.00	48,008	1.00	49,448
EDN100/AA	7/27/2011	67495	SECONDARY TEACHER	Certificated	T03	05	P	A	1.00	49,448	1.00	49,448
EDN150/FA	7/27/2011	74159	SPEC ED TEACHER	Certificated	T03	05	P	A	1.00	55,622	1.00	49,448
EDN100/AA	7/27/2011	64490	ELEM TEACHER	Certificated	T04	05	P	A	1.00	48,008	1.00	49,928
EDN150/FA	7/27/2011	72252	SPEC ED TEACHER	Certificated	T04	05	P	A	1.00	48,008	1.00	49,928
EDN100/AA	7/27/2011	63701	ELEM TEACHER	Certificated	T04	05	T	A	1.00	49,303	1.00	49,928
EDN150/FA	7/27/2011	66330	GEN EDUC/ARTICLE VI TCHR	Certificated	T04	05	P	A	1.00	51,426	1.00	50,654

<u>Prog ID/Org</u>	<u>Separation Date</u>	<u>Position Number</u>	<u>Position Title</u>	<u>Exempt (Y/N)</u>	<u>SR Level</u>	<u>BU Code</u>	<u>T/P</u>	<u>MOF</u>	<u>Budgeted FTE</u>	<u>Budgeted Salary</u>	<u>Actual FTE</u>	<u>Actual Salary</u>
EDN100/DB	7/27/2011	79823	ELEM TEACHER	Certificated	T04	05	T	N			1.00	50,654
EDN100/AA	7/27/2011	61153	ELEM TEACHER	Certificated	T03	05	P	A	1.00	50,931	1.00	50,931
EDN100/AA	7/27/2011	61497	ELEM TEACHER	Certificated	T03	05	P	A	1.00	43,157	1.00	50,931
EDN150/FA	7/27/2011	64954	SPEC ED TEACHER	Certificated	T03	05	P	A	1.00	43,157	1.00	50,931
EDN100/AA	7/27/2011	600211	ELEM TEACHER	Certificated	T04	05	T	A			1.00	51,426
EDN150/FA	7/27/2011	67019	GEN EDUC/ARTICLE VI TCHR	Certificated	T04	05	T	A	1.00	51,426	1.00	51,426
EDN100/AA	7/27/2011	64423	ELEM TEACHER	Certificated	T04	05	P	A	1.00	51,426	1.00	51,426
EDN100/AA	7/27/2011	67069	SECONDARY TEACHER	Certificated	T04	05	T	A	1.00	49,448	1.00	51,426
EDN100/AA	7/27/2011	73879	SECONDARY TEACHER	Certificated	T04	05	P	A	1.00	51,426	1.00	51,426
EDN150/FA	7/27/2011	67725	SPEC ED TEACHER	Certificated	T04	05	P	A	1.00	49,448	1.00	51,426
EDN150/FA	7/27/2011	64639	SPEC ED TCHR/PRE-SCHOOL	Certificated	T04	05	P	A	1.00	51,426	1.00	51,426
EDN150/FB	7/27/2011	60284	SPECIAL SCH TEACHER	Certificated	T04	05	P	A	1.00	52,471	1.00	51,426
EDN100/AA	7/27/2011	69017	ELEM TEACHER	Certificated	T04	05	P	A	1.00	52,471	1.00	51,426
EDN100/AA	7/27/2011	600531	SECONDARY TEACHER	Certificated	T04	05	T	A			1.00	51,426
EDN100/AA	7/27/2011	75035X	ELEM TEACHER	Certificated	T04	05	T	A	1.00	51,426	1.00	51,426
EDN150/FA	7/27/2011	61081	SPEC ED TCHR/PRE-SCHOOL	Certificated	T04	05	P	A	1.00	51,426	1.00	51,426
EDN150/NB	7/27/2011	600815	DIST OFF TCHR	Certificated	T04	05	T	N			1.00	51,426
EDN100/AA	7/27/2011	73887	SECONDARY TEACHER	Certificated	T05	05	P	A	1.00	51,925	1.00	51,925
EDN100/AA	7/27/2011	65788	SECONDARY TEACHER	Certificated	T05	05	P	A	1.00	53,483	1.00	52,680
EDN100/AA	7/27/2011	71386	COUNSELOR	Certificated	T04	05	P	A	1.00	49,448	1.00	52,968
EDN150/FA	7/27/2011	71262	SPEC ED TEACHER	Certificated	T04	05	P	A	1.00	45,785	1.00	52,968
EDN100/AA	7/27/2011	62047	SECONDARY TEACHER	Certificated	T05	05	P	A	1.00	51,426	1.00	53,483
EDN150/FA	7/27/2011	72322	GEN EDUC/ARTICLE VI TCHR	Certificated	T05	05	P	A	1.00	53,483	1.00	53,483
EDN100/AA	7/27/2011	65418	ELEM TEACHER	Certificated	T05	05	P	A	1.00	54,528	1.00	53,483
EDN100/AA	7/27/2011	62664	ELEM TEACHER	Certificated	T05	05	P	A	1.00	46,609	1.00	53,483
EDN100/AA	7/27/2011	74861	ELEM TEACHER	Certificated	T05	05	P	A	1.00	54,528	1.00	53,483
EDN100/AA	7/27/2011	64465	SECONDARY TEACHER	Certificated	T04	05	T	A	1.00	54,558	1.00	54,558
EDN100/AA	7/27/2011	69226	SECONDARY TEACHER	Certificated	T06	05	T	A	1.00	56,917	1.00	54,787
EDN150/FA	7/27/2011	66733	GEN EDUC/ARTICLE VI TCHR	Certificated	T05	05	P	A	1.00	56,132	1.00	55,087
EDN100/AA	7/27/2011	74683	SECONDARY TEACHER	Certificated	T05	05	P	A	1.00	55,087	1.00	55,087
EDN100/AA	7/27/2011	61177	ELEM TEACHER	Certificated	T05	05	P	A	1.00	43,157	1.00	55,087
EDN100/AA	7/27/2011	75010	COUNSELOR/HIGH RISK	Certificated	T06	05	P	A	1.00	55,622	1.00	55,622
EDN150/FA	7/27/2011	75848	SPEC ED TEACHER	Certificated	T06	05	T	A	1.00	43,157	1.00	55,622
EDN100/AA	7/27/2011	74033	COUNSELOR	Certificated	T06	05	P	A	1.00	55,622	1.00	55,622
EDN100/AA	7/27/2011	69009	ELEM TEACHER	Certificated	T05	05	P	A	1.00	56,740	1.00	56,740
EDN100/AA	7/27/2011	72026	SECONDARY TEACHER	Certificated	T05	05	P	A	1.00	43,157	1.00	56,740
EDN100/AA	7/27/2011	66662	ELEM TEACHER	Certificated	T07	05	P	A	1.00	58,959	1.00	58,959
EDN100/BB	7/27/2011	66531	SECONDARY TEACHER	Certificated	T07	05	P	A	1.00	79,170	1.00	58,959
EDN100/AA	7/27/2011	64168	ELEM TEACHER	Certificated	T07	05	T	A	1.00	58,959	1.00	58,959
EDN100/AA	7/27/2011	69989	SECONDARY TEACHER	Certificated	T07	05	T	A			1.00	58,959
EDN150/YC	7/27/2011	800437	SCHOOL PSYCHOLOGIST	Y	SR24	13	P	A	1.00	67,428	1.00	60,024
EDN100/AA	7/27/2011	63115X	SECONDARY TEACHER	Certificated	T05	05	T	A	1.00	46,608	1.00	60,195
EDN100/AA	7/27/2011	60777	SECONDARY TEACHER	Certificated	T07	05	P	A	1.00	66,774	1.00	60,729
EDN100/AA	7/27/2011	61945	SECONDARY TEACHER	Certificated	T07	05	P	A	1.00	55,622	1.00	60,729
EDN100/AA	7/27/2011	66397	SECONDARY TEACHER	Certificated	T07	05	P	A	1.00	46,609	1.00	60,729

Department of Education
Personnel Separations

Table 15

<u>Prog ID/Org</u>	<u>Separation Date</u>	<u>Position Number</u>	<u>Position Title</u>	<u>Exempt (Y/N)</u>	<u>SR Level</u>	<u>BU Code</u>	<u>T/P</u>	<u>MOF</u>	<u>Budgeted FTE</u>	<u>Budgeted Salary</u>	<u>Actual FTE</u>	<u>Actual Salary</u>
EDN100/AA	7/27/2011	62692	ELEM TEACHER	Certificated	T07	05	P	A	1.00	53,483	1.00	60,729
EDN150/FA	7/27/2011	66610	GEN EDUC/ARTICLE VI TCHR	Certificated	T07	05	P	A	1.00	49,448	1.00	60,729
EDN150/FA	7/27/2011	67152	SPEC ED TEACHER	Certificated	T07	05	P	A	1.00	58,959	1.00	62,550
EDN100/AA	7/27/2011	600180	ELEM TEACHER	Certificated	T07	05	T	A			1.00	62,550
EDN100/AA	7/27/2011	61116	ELEM TEACHER	Certificated	T07	05	P	A	1.00	49,448	1.00	62,550
EDN100/AA	7/27/2011	65502	ELEM TEACHER	Certificated	T07	05	P	A	1.00	46,609	1.00	62,550
EDN100/AA	7/27/2011	63941	ELEM TEACHER	Certificated	T07	05	P	A	1.00	62,550	1.00	62,550
EDN100/AA	7/27/2011	69255	ELEM TEACHER	Certificated	T07	05	P	A	1.00	45,785	1.00	62,550
EDN100/AA	7/27/2011	68997	ELEM TEACHER	Certificated	T07	05	P	A	1.00	69,427	1.00	64,427
EDN100/AA	7/27/2011	67407	SECONDARY TEACHER	Certificated	T06	05	P	A	1.00	46,609	1.00	64,482
EDN100/AA	7/27/2011	62313	SECONDARY TEACHER	Certificated	T06	05	P	A	1.00	64,482	1.00	64,482
EDN100/AA	7/27/2011	62078	ELEM TEACHER	Certificated	T07	05	P	A	1.00	69,396	1.00	68,351
EDN100/AA	7/27/2011	63722	ELEM TEACHER	Certificated	T07	05	P	A	1.00	43,157	1.00	68,351
EDN100/AA	7/27/2011	60253	COUNSELOR	Certificated	T07	05	P	A	1.00	70,400	1.00	70,400
EDN100/AA	7/28/2011	30610	SCHOOL SECURITY ATTENDANT	N	SR07	03	P	A	1.00	23,229	1.00	22,250
EDN150/YG	7/28/2011	801704	EDUC ASST III	Y	SR12	03	T	A			1.00	25,030
EDN150/YG	7/28/2011	801714	EDUC ASST III	Y	SR12	03	T	A			1.00	25,030
EDN150/YG	7/28/2011	800728	SOCIAL WORKER II	N	SR18	13	P	A	1.00	45,576	1.00	38,988
EDN100/AA	7/28/2011	60384	SECONDARY TEACHER	Certificated	T02	05	P	A	1.00	44,452	1.00	44,452
EDN100/AA	7/28/2011	60384	SECONDARY TEACHER	Certificated	T05	05	P	A	1.00	44,452	1.00	53,483
EDN100/AA	7/28/2011	74018X	SECONDARY TEACHER	Certificated	T05	05	T	A			1.00	53,483
EDN400/MD	7/29/2011	32437	CAFETERIA HELPER	N	BC02	01	T	N	0.50	16,614	0.50	16,614
EDN400/MD	7/29/2011	51654	CAFETERIA HELPER	N	BC02	01	T	N	0.50	16,614	0.50	16,614
EDN400/MD	7/29/2011	53155	CAFETERIA HELPER	N	BC02	01	T	N			0.50	16,614
EDN100/AA	7/29/2011	600251	SECONDARY TEACHER	Certificated	T07	05	T	A			1.00	59,818
EDN100/AA	7/29/2011	75204	VICE PRINCIPAL III	Certificated	E05	06	P	A	1.00	74,523	1.00	69,097
EDN100/AA	7/30/2011	31268	SCHOOL CUSTODIAN II	N	BC02	01	P	A	0.50	16,614	0.50	16,614
EDN150/FA	7/30/2011	800607	EDUC ASST II	Y	SR10	03	T	A	1.00	26,131	1.00	23,130
EDN150/FA	7/30/2011	58888	EDUC ASST III	Y	SR12	03	T	A			1.00	29,220
EDN150/FA	7/30/2011	29645	EDUC ASST III	Y	SR12	03	P	A	1.00	30,506	1.00	29,220
EDN150/FA	7/30/2011	53006	EDUC ASST III	Y	SR12	03	P	A	1.00	30,506	1.00	29,220
EDN150/FA	7/30/2011	48794	EDUC ASST III	Y	SR12	03	T	A	1.00	30,506	1.00	29,220
EDN100/AA	7/30/2011	39003	CLERK TYPIST II	N	SR08	03	P	A	1.00	30,036	1.00	30,036
EDN500/WA	7/30/2011	48491	CLERK TYPIST II	N	SR08	03	T	W			1.00	32,424
EDN100/AA	7/30/2011	12126	CLERK TYPIST II	N	SR08	03	P	A	1.00	26,700	1.00	32,424
EDN100/AA	7/30/2011	19549	EDUC ASST III	Y	SR12	03	P	A	1.00	34,347	1.00	32,900
EDN100/AA	7/30/2011	16245	SCHOOL CUSTODIAN III	N	WS02	01	P	A	1.00	35,544	1.00	35,544
EDN400/MD	7/30/2011	12136	SCHOOL COOK II	N	BC06	01	P	A			1.00	38,436
EDN100/AA	7/30/2011	27205	ACCOUNT CLERK III	N	SR11	03	P	A	1.00	39,480	1.00	39,480
EDN150/YC	7/30/2011	58752	BEHAVIORAL HLTH SPCLT III	N	SR20	13	P	A	1.00	45,576	1.00	42,132
EDN100/AA	7/30/2011	19060	ACCOUNT CLERK III	N	SR11	03	P	A	1.00	44,412	1.00	44,412
EDN150/SA	7/30/2011	56314	OCC THERAPIST IV	N	SR22	13	P	A	1.00	54,636	1.00	45,576
EDN100/BM	7/30/2011	800799	ATHLETIC HLTH CARE TRAINER	Y	SR22	13	P	A	1.00	45,576	1.00	45,576
EDN400/MD	7/30/2011	54717	SCHOOL FOOD SERVICES MGR III	N	F206	02	P	A	1.00	47,456	1.00	46,212
EDN400/MD	7/30/2011	380	SCHOOL FOOD SERVICES MGR III	N	F206	02	P	A	1.00	48,429	1.00	47,160

<u>Prog ID/Org</u>	<u>Separation Date</u>	<u>Position Number</u>	<u>Position Title</u>	<u>Exempt (Y/N)</u>	<u>SR Level</u>	<u>BU Code</u>	<u>T/P</u>	<u>MOF</u>	<u>Budgeted FTE</u>	<u>Budgeted Salary</u>	<u>Actual FTE</u>	<u>Actual Salary</u>
EDN100/AA	7/30/2011	71626	SECONDARY TEACHER	Certificated	T03	05	P	A	1.00	48,008	1.00	48,706
EDN400/MD	7/30/2011	10515	SCHOOL FOOD SERVICES MGR III	N	F206	02	P	A	1.00	50,376	1.00	49,056
EDN150/YC	7/30/2011	58463	BEHAVIORAL HLTH SPCLT IV	N	SR22	13	P	A	1.00	57,708	1.00	57,708
EDN100/AA	8/1/2011	66598	SECONDARY TEACHER	Certificated	T03	05	P	A	0.50	26,230	0.50	26,230
EDN100/AA	8/1/2011	62712	COUNSELOR	Certificated	T06	05	P	A	1.00	57,291	0.50	28,215
EDN100/AA	8/1/2011	74203	SECONDARY TEACHER	Certificated	T04	05	P	A	1.00	54,558	1.00	53,739
EDN150/FA	8/1/2011	71574	SPEC ED TEACHER	Certificated	T04	05	P	A	1.00	54,558	1.00	54,558
EDN100/AA	8/1/2011	67573	ELEM TEACHER	Certificated	T05	05	P	A	1.00	55,087	1.00	55,087
EDN150/FA	8/1/2011	76068	SPEC ED TEACHER	Certificated	T05	05	P	A	1.00	56,740	1.00	55,888
EDN150/FA	8/1/2011	73583	SPEC ED TEACHER	Certificated	T06	05	P	A	1.00	60,779	1.00	59,867
EDN100/DB	8/1/2011	79765	SECONDARY TEACHER	Certificated	T06	05	T	N			1.00	59,867
EDN100/BB	8/1/2011	63065	SECONDARY TEACHER	Certificated	T05	05	P	A	1.00	54,528	1.00	61,071
EDN100/AA	8/1/2011	72378	ELEM TEACHER	Certificated	T07	05	P	A	1.00	62,550	1.00	61,611
EDN150/FA	8/1/2011	61613	SPEC ED TEACHER	Certificated	T06	05	P	A	1.00	64,482	1.00	63,514
EDN100/AA	8/1/2011	71680	ELEM TEACHER	Certificated	T07	05	P	A	1.00	68,351	1.00	67,325
EDN150/FA	8/1/2011	602067	GEN EDUC/ARTICLE VI TCHR	Certificated	T07	05	T	A			1.00	69,344
EDN100/AA	8/1/2011	67644	COUNSELOR	Certificated	T07	05	P	A	1.00	70,400	1.00	69,344
EDN100/AA	8/1/2011	60344	SECONDARY TEACHER	Certificated	T06	05	P	A	1.00	70,461	1.00	69,404
EDN150/FA	8/1/2011	65444	GEN EDUC/ARTICLE VI TCHR	Certificated	T05	05	P	A	1.00	71,815	1.00	70,737
EDN100/AA	8/1/2011	62124	SECONDARY TEACHER	Certificated	T07	05	P	A	1.00	72,513	1.00	71,425
EDN100/AA	8/1/2011	61277	COUNSELOR	Certificated	T07	05	P	A	1.00	72,513	1.00	71,425
EDN200/GQ	8/1/2011	76174	STATE OFFICE TEACHER	Certificated	T06	05	T	A	1.00	74,688	1.00	73,567
EDN150/FA	8/1/2011	76166	SPEC ED TCHR/PRE-SCHOOL	Certificated	T07	05	P	A	1.00	75,733	1.00	73,567
EDN100/AA	8/1/2011	69877	SECONDARY TEACHER	Certificated	T07	05	P	A	1.00	79,170	1.00	77,982
EDN100/AA	8/1/2011	61684	SECONDARY TEACHER	Certificated	T07	05	P	A	1.00	79,170	1.00	77,982
EDN100/AA	8/1/2011	60807	SECONDARY TEACHER	Certificated	T07	05	P	A	1.00	79,170	1.00	77,982
EDN150/SA	8/1/2011	60011	DISTRICT EDUC SPEC II	Certificated	E07	06	P	A	1.00	93,626	1.00	93,626
EDN100/BJ	8/1/2011	63847	12-MO HS PRIN V	Certificated	E08	06	P	A	1.00	121,294	1.00	121,294
EDN100/AA	8/1/2011	65278	12-MO HS PRIN VI	Certificated	E09	06	P	A	1.00	137,459	1.00	137,459
EDN150/FA	8/2/2011	801887	EDUC ASST III	Y	SR12	03	T	A			1.00	25,030
EDN150/SA	8/2/2011	30482	COMMUNICATION AIDE	Y	SR12	03	P	A	1.00	31,769	1.00	30,430
EDN150/SA	8/2/2011	30572	OCC THERAPIST IV	N	SR22	13	P	A	1.00	59,904	1.00	47,412
EDN150/YG	8/3/2011	801817	SOCIAL WORKER IV	N	SR22	13	P	A			1.00	23,663
EDN100/AA	8/4/2011	64240	SECONDARY TEACHER	Certificated	T02	05	P	A	1.00	48,008	1.00	42,509
EDN100/AA	8/4/2011	1842	SCHOOL ADM SERVICES ASST III	Certificated	SR16	04	P	A	1.00	44,412	1.00	44,412
EDN150/YC	8/4/2011	58334	BEHAVIORAL HLTH SPCLT IV	N	SR22	13	P	A	1.00	45,576	1.00	45,576
EDN100/AA	8/4/2011	64764	SECONDARY TEACHER	Certificated	T03	05	P	A	1.00	40,567	1.00	45,909
EDN100/AA	8/4/2011	27133	SCHOOL ADM SERVICES ASST II	Certificated	SR14	04	P	A	1.00	48,048	1.00	48,048
EDN150/YG	8/5/2011	801831	EDUC ASST III	Y	SR12	03	T	A			1.00	30,036
EDN150/FA	8/6/2011	55373	EDUC ASST III	Y	SR12	03	P	A	0.75	22,879	0.75	21,915
EDN400/MD	8/6/2011	14636	CAFETERIA HELPER	N	BC02	01	P	A			1.00	33,228
EDN100/AA	8/6/2011	73808	SECONDARY TEACHER	Certificated	T03	05	P	A	1.00	43,157	1.00	45,909
EDN150/YC	8/6/2011	58404	BEHAVIORAL HLTH SPCLT IV	N	SR22	13	P	A	1.00	49,332	1.00	49,332
EDN100/AA	8/6/2011	63159	SECONDARY TEACHER	Certificated	T05	05	T	A	1.00	43,157	1.00	52,680
EDN100/AA	8/9/2011	58838	SCHOOL CUSTODIAN II	N	BC02	01	P	A	0.50	16,614	0.50	16,614

Prog ID/Org	Separation Date	Position Number	Position Title	Exempt (Y/N)	SR Level	BU Code	T/P	MOF	Budgeted FTE	Budgeted Salary	Actual FTE	Actual Salary
EDN100/AA	8/10/2011	46276	SCHOOL CUSTODIAN II	N	BC02	01	P	A	0.50	16,614	0.50	16,614
EDN300/UA	8/10/2011	55541	DATA PROCSSG SYSTS ANAL II	N	SR18	13	P	A	1.00	45,576	1.00	38,988
EDN200/GN	8/12/2011	800805	BUSINESS MGMT OFFICER I	N	EM05	13	P	A	1.00	73,284	1.00	71,760
EDN150/FA	8/13/2011	39156	EDUC ASST III	Y	SR12	03	P	A	0.50	13,577	0.50	13,005
EDN150/FA	8/13/2011	57271	EDUC ASST III	Y	SR12	03	T	A	0.75	21,157	0.75	18,773
EDN150/YG	8/13/2011	800831	EDUC ASST III	Y	SR12	03	T	A			1.00	25,030
EDN150/FA	8/13/2011	75520	SPEC ED TEACHER	Certificated	T03	05	T	A			1.00	45,909
EDN150/FA	8/13/2011	63289	SPEC ED TEACHER	Certificated	T06	05	P	A	1.00	56,917	1.00	54,787
EDN150/FA	8/16/2011	55379	EDUC ASST III	Y	SR12	03	P	A	0.75	23,827	0.75	22,823
EDN100/AA	8/16/2011	61649	SECONDARY TEACHER	Certificated	T03	05	P	A	0.50	30,365	1.00	45,909
EDN150/FA	8/16/2011	73368	SPEC ED TEACHER	Certificated	T03	05	P	A	1.00	49,448	1.00	48,706
EDN100/AA	8/16/2011	64802	SECONDARY TEACHER	Certificated	T04	05	P	A	1.00	52,968	1.00	52,173
EDN150/YC	8/17/2011	58696	BEHAVIORAL HLTH SPCLT III	N	SR20	13	T	A	1.00	47,412	1.00	42,132
EDN100/AA	8/17/2011	64859	ELEM TEACHER	Certificated	T03	05	T	A	1.00	47,904	1.00	45,909
EDN150/YG	8/18/2011	801836	EDUC ASST I	Y	SR08	03	T	A			1.00	13,327
EDN150/YG	8/20/2011	801868	EDUC ASST II	Y	SR10	03	T	A			1.00	23,130
EDN150/FA	8/23/2011	58783	EDUC ASST III	Y	SR12	03	P	A	1.00	26,131	1.00	25,030
EDN150/YG	8/23/2011	59555	BEHAVIORAL HLTH SPCLT III	N	SR20	13	P	A	1.00	45,576	1.00	42,132
EDN400/MD	8/24/2011	56472	CAFETERIA HELPER	N	BC02	01	T	N			0.50	16,614
EDN100/AA	8/24/2011	74400	ELEM TEACHER	Certificated	T02	05	T	A	1.00	51,426	1.00	42,509
EDN100/AA	8/25/2011	68374	SECONDARY TEACHER	Certificated	T05	05	P	A	1.00	54,778	1.00	52,680
EDN100/AA	8/25/2011	72301	SECONDARY TEACHER	Certificated	T07	05	P	A	1.00	60,729	1.00	59,818
EDN100/AA	8/26/2011	23339	CLERK TYPIST II	N	SR08	03	P	A	1.00	25,668	1.00	25,668
EDN150/FA	8/27/2011	801902	EDUC ASST II	Y	SR10	03	P	A			0.50	11,565
EDN150/FA	8/27/2011	57477	EDUC ASST III	Y	SR12	03	T	A	0.50	13,066	0.50	12,515
EDN150/NB	8/27/2011	800183	EDUC ASST III	Y	SR12	03	T	N			1.00	25,030
EDN100/AA	8/27/2011	16176	SCHOOL CUSTODIAN II	N	BC02	01	P	A	1.00	33,228	1.00	33,228
EDN100/AA	8/27/2011	67801	ELEM TEACHER	Certificated	T02	05	P	A	1.00	72,513	1.00	43,785
EDN150/FA	8/30/2011	56128	EDUC ASST III	Y	SR12	03	P	A	0.75	20,366	0.75	19,508
EDN150/FA	8/30/2011	801259	EDUC ASST III	Y	SR12	03	T	A			1.00	25,030
EDN150/YC	8/31/2011	58471	BEHAVIORAL HLTH SPCLT IV	N	SR22	13	P	A	1.00	57,708	1.00	57,708
EDN150/SA	9/1/2011	30462	COMMUNICATION AIDE	Y	SR12	03	P	A	0.50	17,174	0.50	12,515
EDN150/FA	9/1/2011	54721	EDUC ASST III	Y	SR12	03	P	A	0.50	14,684	0.50	14,065
EDN100/AA	9/1/2011	16443	SCHOOL CUSTODIAN II	N	BC02	01	P	A	0.50	16,614	0.50	16,614
EDN150/FA	9/1/2011	58133	EDUC ASST III	Y	SR12	03	P	A	0.75	21,157	0.75	20,265
EDN150/FA	9/1/2011	56024	EDUC ASST III	Y	SR12	03	P	A	1.00	26,131	1.00	25,030
EDN150/YG	9/1/2011	801524	EDUC ASST III	Y	SR12	03	T	A			1.00	25,030
EDN400/MD	9/1/2011	801153	CLERK TYPIST II	N	SR08	03	T	N	1.00	25,668	1.00	25,668
EDN100/AA	9/1/2011	601696	SECONDARY TEACHER	Certificated	T04	05	T	A			0.50	27,676
EDN150/FA	9/1/2011	52706	EDUC ASST III	Y	SR12	03	T	A			1.00	29,220
EDN100/AA	9/1/2011	26427	SCHOOL CUSTODIAN II	N	BC02	01	P	A	1.00	33,228	1.00	33,228
EDN200/GN	9/1/2011	11394	PRIVATE SECRETARY I	N	SR20	03	P	A	1.00	63,204	1.00	42,684
EDN150/SA	9/1/2011	56046	SPEECH PATHOLOGIST IV	Y	SR22	13	P	A	1.00	65,054	1.00	51,312
EDN100/AA	9/1/2011	60668	ELEM TEACHER	Certificated	T04	05	P	A	1.00	52,968	1.00	52,173
EDN150/FA	9/1/2011	75953	GEN EDUC/ARTICLE VI TCHR	Certificated	T03	05	P	A	1.00	54,033	1.00	53,222

Department of Education
Personnel Separations

Table 15

<u>Prog ID/Org</u>	<u>Separation Date</u>	<u>Position Number</u>	<u>Position Title</u>	<u>Exempt (Y/N)</u>	<u>SR Level</u>	<u>BU Code</u>	<u>T/P</u>	<u>MOF</u>	<u>Budgeted FTE</u>	<u>Budgeted Salary</u>	<u>Actual FTE</u>	<u>Actual Salary</u>
EDN150/FA	9/1/2011	62236	GEN EDUC/ARTICLE VI TCHR	Certificated	T04	05	P	A	1.00	32,713	1.00	53,739
EDN100/AA	9/1/2011	17830	SCHOOL ADM SERVICES ASST IV	Certificated	SR18	04	P	A	1.00	54,012	1.00	54,012
EDN100/AA	9/1/2011	72936	COUNSELOR	Certificated	T06	05	T	A			1.00	54,787
EDN400/MB	9/1/2011	58608	SCHOOL LUNCH SERVICES SUPVR	N	SR24	13	P	B	1.00	55,500	1.00	55,500
EDN100/AA	9/1/2011	73925	SECONDARY TEACHER	Certificated	T06	05	P	A	1.00	57,291	1.00	56,431
EDN100/AA	9/1/2011	65451	SECONDARY TEACHER	Certificated	T05	05	P	A	1.00	58,442	1.00	57,565
EDN150/FA	9/1/2011	71327	SPEC ED TEACHER	Certificated	T07	05	P	A	1.00	58,959	1.00	58,074
EDN100/AA	9/1/2011	69337	ELEM TEACHER	Certificated	T07	05	P	A	1.00	58,959	1.00	58,074
EDN100/BB	9/1/2011	66152	SECONDARY TEACHER	Certificated	T03	05	P	A	1.00	59,043	1.00	58,157
EDN100/AA	9/1/2011	64906	SECONDARY TEACHER	Certificated	T05	05	P	A	1.00	65,752	1.00	61,071
EDN100/AA	9/1/2011	72352	SECONDARY TEACHER	Certificated	T07	05	P	A	1.00	63,595	1.00	61,611
EDN100/AA	9/1/2011	65504	ELEM TEACHER	Certificated	T04	05	P	A	1.00	65,145	1.00	64,167
EDN100/AA	9/1/2011	68879	ELEM TEACHER	Certificated	T07	05	P	A	1.00	67,404	1.00	65,363
EDN150/FA	9/1/2011	74376	SPEC ED TEACHER	Certificated	T03	05	P	A	1.00	66,397	1.00	65,401
EDN100/AA	9/1/2011	69821	ELEM TEACHER	Certificated	T07	05	P	A	1.00	68,351	1.00	67,325
EDN100/AA	9/1/2011	60289	SECONDARY TEACHER	Certificated	T07	05	P	A	1.00	69,396	1.00	67,325
EDN150/SA	9/1/2011	30439	SPEECH PATHOLOGIST IV	Y	SR22	13	P	A	1.00	69,305	1.00	67,488
EDN100/AA	9/1/2011	65770	ELEM TEACHER	Certificated	T07	05	P	A	1.00	72,513	1.00	71,425
EDN100/AA	9/1/2011	64440	VICE PRINCIPAL II	Certificated	E04	06	P	A	1.00	83,291	1.00	77,226
EDN150/NB	9/1/2011	79854	12-MO DIST OFF TCHR	Certificated	T07	05	T	N			1.00	77,982
EDN100/AA	9/1/2011	600127	12-MONTH REGISTRAR	Certificated	T07	05	T	A			1.00	77,982
EDN100/AA	9/1/2011	64592	COUNSELOR	Certificated	T07	05	P	A	1.00	79,170	1.00	77,982
EDN300/KF	9/1/2011	69290	FISCAL SPECIALIST II	Certificated	E07	06	P	A	1.00	78,146	1.00	78,146
EDN100/CQ	9/1/2011	73595	EDUCATIONAL SPEC II	Certificated	E07	06	P	A	1.00	79,242	1.00	79,242
EDN100/AA	9/1/2011	71409	VICE PRINCIPAL I	Certificated	E03	06	P	A	1.00	93,089	1.00	86,311
EDN300/KD	9/1/2011	60001	ADM ASST TO THE SUPT	Certificated	E10	06	P	A	1.00	123,642	1.00	123,642
EDN150/FA	9/3/2011	57103	EDUC ASST III	Y	SR12	03	P	A	1.00	29,368	1.00	28,130
EDN100/AA	9/3/2011	62568	SECONDARY TEACHER	Certificated	T02	05	P	A	1.00	62,550	1.00	42,509
EDN100/AA	9/3/2011	71621	SECONDARY TEACHER	Certificated	T03	05	T	A	1.00	49,448	1.00	48,706
EDN100/AA	9/3/2011	68592	SECONDARY TEACHER	Certificated	T07	05	P	A	1.00	58,959	1.00	58,074
EDN150/FB	9/6/2011	60267	SPECIAL SCH TEACHER	Certificated	T03	05	P	A	1.00	35,329	1.00	47,287
EDN150/FA	9/7/2011	57274	EDUC ASST II	Y	SR10	03	T	A	0.75	19,599	0.75	17,348
EDN100/AA	9/7/2011	601624	ELEM TEACHER	Certificated	T03	05	T	A			1.00	48,706
EDN100/AA	9/8/2011	44051	LIBRARY ASSISTANT III	N	SR07	03	P	A	1.00	26,700	1.00	26,700
EDN400/YA	9/9/2011	59098	BUS DRIVER	N	BC07	01	P	A	0.50	19,986	0.50	19,986
EDN100/AA	9/9/2011	55353	CLERK II	N	SR06	03	P	A	1.00	27,756	1.00	25,668
EDN150/FA	9/10/2011	52570	EDUC ASST III	Y	SR12	03	P	A	1.00	31,769	1.00	30,430
EDN150/FA	9/10/2011	64822	SPEC ED TEACHER	Certificated	T02	05	P	A	1.00	53,483	1.00	42,509
EDN150/FA	9/10/2011	73377	SPEC ED TEACHER	Certificated	T03	05	P	A	1.00	50,931	1.00	50,167
EDN150/FA	9/13/2011	58948	EDUC ASST III	Y	SR12	03	P	A	1.00	29,368	1.00	28,130
EDN150/FA	9/13/2011	32047	EDUC ASST III	Y	SR12	03	P	A	1.00	33,032	1.00	31,640
EDN100/AA	9/13/2011	1872	SCHOOL ADM SERVICES ASST III	Certificated	SR16	04	P	A	1.00	41,040	1.00	41,040
EDN150/FA	9/14/2011	58953	EDUC ASST III	Y	SR12	03	P	A	0.75	22,026	0.75	21,097
EDN400/MD	9/15/2011	801839	CAFETERIA HELPER	N	BC02	01	P	A			0.50	16,614
EDN150/FA	9/16/2011	57669	EDUC ASST III	Y	SR12	03	T	A	1.00	30,506	0.75	21,915

Prog ID/Org	Separation Date	Position Number	Position Title	Exempt (Y/N)	SR Level	BU Code	T/P	MOF	Budgeted FTE	Budgeted Salary	Actual FTE	Actual Salary
EDN100/AA	9/17/2011	45157	CLERK II	N	SR06	03	P	A	1.00	26,700	1.00	23,688
EDN300/UA	9/17/2011	53195	SECRETARY II	N	SR14	03	P	A	1.00	37,968	1.00	37,968
EDN100/BM	9/17/2011	52471	ATHLETIC HLTH CARE TRAINER	Y	SR22	13	P	A	1.00	45,576	1.00	45,576
EDN100/AA	9/17/2011	602284	SPEC ED TEACHER	Certificated	T03	05	T	A			1.00	47,287
EDN150/FA	9/18/2011	55209	EDUC ASST III	Y	SR12	03	P	A	1.00	30,506	1.00	29,220
EDN100/AA	9/20/2011	801961	EDUC ASST II	Y	SR10	03	T	A			1.00	23,130
EDN400/MD	9/20/2011	45855	FOOD SERVICES DRIVER	N	BC03	01	P	A			1.00	34,164
EDN150/YG	9/20/2011	801353	HUMAN SVCS PROF IV	N	SR22	13	P	A			1.00	45,576
EDN150/FA	9/21/2011	57141	EDUC ASST II	Y	SR10	03	T	A			1.00	23,130
EDN150/SA	9/21/2011	56191	SPEECH PATHOLOGIST II	Y	SR18	13	P	A	1.00	56,247	1.00	38,988
EDN100/AA	9/21/2011	600239	COUNSELOR	Certificated	T03	05	T	A			1.00	48,706
EDN150/YG	9/22/2011	801529	EDUC ASST III	Y	SR12	03	T	A			1.00	25,030
EDN150/NB	9/22/2011	55293	CLERK TYPIST II	N	SR08	03	T	N			1.00	25,668
EDN150/YC	9/22/2011	58406	BEHAVIORAL HLTH SPCLT IV	N	SR22	13	P	A	1.00	57,708	1.00	57,708
EDN150/FA	9/24/2011	801888	EDUC ASST II	Y	SR10	03	T	A			1.00	23,130
EDN150/YC	9/24/2011	800442	SCHOOL PSYCHOLOGIST	Y	SR24	13	P	A	1.00	58,716	1.00	51,312
EDN100/BM	9/24/2011	52460	ATHLETIC HLTH CARE TRAINER	Y	SR22	13	P	A	1.00	51,312	1.00	51,312
EDN400/MD	9/28/2011	9267	CAFETERIA HELPER	N	BC02	01	P	A			0.50	16,614
EDN100/AA	9/28/2011	602309	SECONDARY TEACHER	Certificated	T03	05	T	A			1.00	45,909
EDN150/FA	9/29/2011	63599	SPEC ED TEACHER	Certificated	T02	05	P	A	1.00	32,713	1.00	45,098
EDN150/FA	10/1/2011	800555	EDUC ASST III	Y	SR12	03	T	A	0.50	13,066	0.50	12,515
EDN100/DL	10/1/2011	58678	CLERK TYPIST II	N	SR08	03	T	N			0.50	12,834
EDN100/AA	10/1/2011	38317	CLERK TYPIST II	N	SR08	03	P	A	0.50	12,834	0.50	12,834
EDN150/FA	10/1/2011	50325	EDUC ASST III	Y	SR12	03	P	A	0.50	14,684	0.50	14,065
EDN400/MD	10/1/2011	49641	CAFETERIA HELPER	N	BC02	01	T	N	0.50	16,614	0.50	16,614
EDN100/AA	10/1/2011	30595	SCHOOL SECURITY ATTENDANT	N	SR07	03	P	A	1.00	21,444	1.00	20,540
EDN200/GH	10/1/2011	801610	CLERK I	N	SR04	03	T	B			1.00	21,948
EDN100/AA	10/1/2011	801515	SCHOOL HEALTH AIDE	N	SR09	03	T	A			1.00	23,741
EDN100/AA	10/1/2011	55954	CLERK III	N	SR08	03	T	A	1.00	30,036	1.00	25,668
EDN150/FA	10/1/2011	48806	EDUC ASST III	Y	SR12	03	P	A	1.00	30,506	1.00	29,220
EDN150/FA	10/1/2011	56156	EDUC ASST III	Y	SR12	03	P	A	1.00	34,347	1.00	32,900
EDN100/AA	10/1/2011	16696	SCHOOL CUSTODIAN II	N	BC02	01	P	A	1.00	33,228	1.00	33,228
EDN150/SA	10/1/2011	33189	CLERK TYPIST II	N	SR08	03	P	A	1.00	33,756	1.00	33,756
EDN100/AA	10/1/2011	16620	SCHOOL CUSTODIAN III	N	WS02	01	P	A	1.00	35,544	1.00	35,544
EDN200/GD	10/1/2011	12310	SECRETARY II	N	SR14	03	P	A	1.00	-	1.00	37,968
EDN200/GP	10/1/2011	14585	SECRETARY II	N	SR14	03	P	A	1.00	41,040	1.00	41,040
EDN100/AA	10/1/2011	69157	ELEM TEACHER	Certificated	T02	05	P	A	1.00	44,202	1.00	42,509
EDN200/GN	10/1/2011	32337	BILINGUAL/BICULTURAL S/H ASST	Y	SR11	03	T	A	1.00	42,684	1.00	42,684
EDN100/AA	10/1/2011	67629	ELEM TEACHER	Certificated	T03	05	P	A	1.00	43,157	1.00	45,909
EDN100/AA	10/1/2011	601283	ELEM TEACHER	Certificated	T03	05	T	A			1.00	45,909
EDN100/AA	10/1/2011	61000	ELEM TEACHER	Certificated	T03	05	P	A	1.00	45,747	1.00	45,909
EDN100/AA	10/1/2011	68263	ELEM TEACHER	Certificated	T03	05	P	A	1.00	51,426	1.00	47,287
EDN150/SA	10/1/2011	56287	SPEECH PATHOLOGIST IV	Y	SR22	13	P	A	1.00	63,644	1.00	49,332
EDN100/AA	10/1/2011	72615	ELEM TEACHER	Certificated	T04	05	P	A	1.00	43,157	1.00	52,173
EDN100/AA	10/1/2011	8743	SCHOOL ADM SERVICES ASST III	Certificated	SR16	04	P	A	1.00	54,012	1.00	54,012

Prog ID/Org	Separation Date	Position Number	Position Title	Exempt (Y/N)	SR Level	BU Code	T/P	MOF	Budgeted FTE	Budgeted Salary	Actual FTE	Actual Salary
EDN150/FA	10/1/2011	62955	GEN EDUC/ARTICLE VI TCHR	Certificated	T05	05	P	A	1.00	56,740	1.00	55,888
EDN150/FA	10/1/2011	64956	GEN EDUC/ARTICLE VI TCHR	Certificated	T04	05	P	A	1.00	46,609	1.00	58,722
EDN100/AA	10/1/2011	67905	COUNSELOR	Certificated	T07	05	P	A	1.00	60,729	1.00	59,818
EDN100/AA	10/1/2011	65205	ELEM TEACHER	Certificated	T07	05	P	A	1.00	62,550	1.00	61,611
EDN100/AA	10/1/2011	71558	ELEM TEACHER	Certificated	T07	05	P	A	1.00	66,359	1.00	65,363
EDN100/BX	10/1/2011	65789	TEACHER/DORMITORY	Certificated	T07	05	P	A	1.00	68,351	1.00	67,325
EDN100/AA	10/1/2011	68324	COUNSELOR	Certificated	T07	05	P	A	1.00	68,351	1.00	67,325
EDN100/DB	10/1/2011	79460	DIST OFF TCHR	Certificated	T07	05	T	N			1.00	67,325
EDN100/AA	10/1/2011	65653	SECONDARY TEACHER	Certificated	T07	05	P	A	1.00	72,513	1.00	71,425
EDN100/AA	10/1/2011	64892	SCH ATHLETIC DIR III	Certificated	E03	06	P	A	1.00	92,334	1.00	92,334
EDN100/AA	10/6/2011	59718	SCHOOL CUSTODIAN II	N	BC02	01	P	A	1.00	33,228	1.00	33,228
EDN150/FA	10/6/2011	65760	SPEC ED TEACHER	Certificated	T02	05	P	A	1.00	47,159	1.00	46,451
EDN400/MD	10/8/2011	9261	SCHOOL COOK II	N	BC06	01	P	A			1.00	38,436
EDN100/AA	10/8/2011	63747	ELEM TEACHER	Certificated	T02	05	P	A	1.00	45,785	1.00	45,098
EDN100/AA	10/8/2011	67036	SECONDARY TEACHER	Certificated	T07	05	P	A	1.00	70,400	1.00	69,344
EDN150/YC	10/11/2011	58747	BEHAVIORAL HLTH SPCLT III	N	SR20	13	P	A	1.00	47,412	1.00	42,132
EDN100/AA	10/11/2011	74536	ELEM TEACHER	Certificated	T02	05	P	A	1.00	68,351	1.00	42,509
EDN150/FA	10/12/2011	52578	EDUC ASST III	Y	SR12	03	P	A	1.00	30,506	1.00	29,220
EDN100/AA	10/12/2011	68358	ELEM TEACHER	Certificated	T03	05	P	A	1.00	70,400	1.00	45,909
EDN100/AA	10/13/2011	63235	SECONDARY TEACHER	Certificated	T07	05	P	A	1.00	62,550	1.00	61,611
EDN400/MD	10/15/2011	801482	CAFETERIA HELPER	N	BC02	01	T	A	0.50	16,614	0.50	16,614
EDN150/YG	10/15/2011	800272	EDUC ASST II	Y	SR10	03	P	A	1.00	26,131	1.00	23,130
EDN150/FA	10/15/2011	73363	SPEC ED TEACHER	Certificated	T02	05	P	A	1.00	68,351	1.00	42,509
EDN150/FA	10/15/2011	63289	SPEC ED TEACHER	Certificated	T03	05	P	A	1.00	56,917	1.00	45,909
EDN400/MD	10/15/2011	50370	SCHOOL FOOD SERVICES MGR III	N	F206	02	P	A	1.00	48,429	1.00	47,160
EDN150/SA	10/15/2011	56356	SPEECH PATHOLOGIST IV	Y	SR22	13	P	A	1.00	60,436	1.00	47,412
EDN100/AA	10/18/2011	55138	EDUC ASST II	Y	SR10	03	P	A	0.50	13,066	0.50	11,565
EDN100/AA	10/18/2011	66144	SECONDARY TEACHER	Certificated	T02	05	P	A	1.00	58,369	1.00	32,222
EDN150/FB	10/18/2011	801442	HSEAPARENT FOR DEAF/BLIND (FP)	N	HE05	10	P	A	1.00	33,756	1.00	33,756
EDN100/AA	10/18/2011	65797	SECONDARY TEACHER	Certificated	T02	05	T	A	1.00	43,157	1.00	42,509
EDN100/DB	10/18/2011	79420	SECONDARY TEACHER	Certificated	T02	05	T	N			1.00	45,098
EDN100/AA	10/18/2011	63404	ELEM TEACHER	Certificated	T02	05	P	A	1.00	51,426	1.00	45,098
EDN100/AA	10/18/2011	65644	COUNSELOR	Certificated	T04	05	T	A	1.00	51,426	1.00	50,654
EDN150/FA	10/18/2011	75853	SPEC ED TEACHER	Certificated	T05	05	P	A	1.00	32,713	1.00	54,260
EDN150/YG	10/22/2011	801734	EDUC ASST III	Y	SR12	03	T	A			1.00	25,030
EDN100/AA	10/22/2011	69458	ELEM TEACHER	Certificated	T03	05	P	A	1.00	74,688	1.00	47,287
EDN150/FA	10/22/2011	601766	SPEC ED TEACHER	Certificated	T03	05	T	A			1.00	48,706
EDN100/AA	10/23/2011	64804	SECONDARY TEACHER	Certificated	T06	05	P	A	1.00	74,688	1.00	73,567
EDN150/YC	10/27/2011	58639	BEHAVIORAL HLTH SPCLT IV	N	SR22	13	T	A	1.00	45,576	1.00	45,576
EDN100/AA	10/27/2011	66485	SECONDARY TEACHER	Certificated	T03	05	P	A	1.00	46,609	1.00	45,909
EDN150/YC	10/28/2011	27394	SCHOOL PSYCHOLOGIST	Y	SR24	13	P	A	1.00	54,788	1.00	26,644
EDN400/MD	10/29/2011	49292	CAFETERIA HELPER	N	BC02	01	T	N			0.50	16,614
EDN150/FA	10/29/2011	57979	EDUC ASST II	Y	SR10	03	T	A	0.75	19,599	0.75	17,348
EDN150/FA	10/29/2011	36809	EDUC ASST III	Y	SR12	03	P	A	1.00	27,154	1.00	26,010
EDN150/SA	10/29/2011	33208	SPEECH PATHOLOGIST III	Y	SR20	13	P	A	1.00	56,247	1.00	42,132

Prog ID/Org	Separation Date	Position Number	Position Title	Exempt (Y/N)	SR Level	BU Code	T/P	MOF	Budgeted FTE	Budgeted Salary	Actual FTE	Actual Salary
EDN150/FA	10/29/2011	65971	SPEC ED TEACHER	Certificated	T03	05	P	A	1.00	48,008	1.00	45,909
EDN100/AA	10/29/2011	60558	SPEC ED TEACHER	Certificated	T03	05	T	A			1.00	45,909
EDN400/MD	11/1/2011	58556	CAFETERIA HELPER	N	BC02	01	T	A			0.50	16,614
EDN100/AA	11/1/2011	56157	EDUC ASST III	Y	SR12	03	P	A	1.00	31,769	1.00	30,430
EDN150/FA	11/1/2011	73678	SPEC ED TCHR/PRE-SCHOOL	Certificated	T02	05	P	A	1.00	51,426	1.00	32,222
EDN400/MD	11/1/2011	12088	CAFETERIA HELPER	N	BC02	01	P	A			1.00	33,228
EDN100/AA	11/1/2011	32672	SCHOOL CUSTODIAN II	N	BC02	01	P	A	1.00	33,228	1.00	33,228
EDN100/AA	11/1/2011	16660	SCHOOL CUSTODIAN II	N	BC02	01	P	A	1.00	33,228	1.00	33,228
EDN400/MD	11/1/2011	9444	SCHOOL BAKER	N	BC06	01	P	A			1.00	38,436
EDN400/MD	11/1/2011	1974	SCHOOL FOOD SERVICES MGR II	N	F106	02	P	A	1.00	44,597	1.00	43,428
EDN100/BM	11/1/2011	48257	ATHLETIC HLTH CARE TRAINER	Y	SR22	13	P	A	1.00	45,576	1.00	45,576
EDN400/OC	11/1/2011	17102	WELDER I	N	BC10	01	P	A	1.00	46,236	1.00	46,236
EDN150/SA	11/1/2011	50768	SOCIAL WORKER IV	N	SR22	13	P	A	1.00	52,694	1.00	51,312
EDN100/AA	11/1/2011	66205	SECONDARY TEACHER	Certificated	T05	05	P	A	1.00	53,483	1.00	52,680
EDN300/KO	11/1/2011	59118	PERSONNEL MGMT SPECIALIST V	N	SR24	13	P	A	1.00	53,352	1.00	53,352
EDN100/AA	11/1/2011	64796	SECONDARY TEACHER	Certificated	T07	05	P	A	1.00	60,729	1.00	59,818
EDN100/AA	11/1/2011	68696	ELEM TEACHER	Certificated	T07	05	P	A	1.00	63,845	1.00	61,611
EDN150/FA	11/1/2011	600611	GEN EDUC/ARTICLE VI TCHR	Certificated	T07	05	T	A			1.00	65,363
EDN300/KF	11/1/2011	58247	PROCUREMENT AND CONTRACTS SUPPORT SPECIALIST VI	N	SR26	13	P	A	1.00	45,576	1.00	75,960
EDN100/AA	11/1/2011	71438	VICE PRINCIPAL III	Certificated	E05	06	P	A	1.00	105,499	1.00	97,817
EDN150/FA	11/3/2011	57483	EDUC ASST III	Y	SR12	03	P	A	0.50	15,253	0.50	12,515
EDN150/YC	11/3/2011	59732	CLINICAL PSYCHOLOGIST VI	N	SR26	13	T	A	1.00	74,160	1.00	55,500
EDN100/AA	11/4/2011	65173	ELEM TEACHER	Certificated	T02	05	T	A	1.00	43,157	1.00	42,509
EDN100/AA	11/4/2011	71704	ELEM TEACHER	Certificated	T02	05	T	A	1.00	43,157	1.00	42,509
EDN100/AA	11/5/2011	58264	EDUC ASST III	Y	SR12	03	P	A	1.00	28,209	1.00	27,020
EDN150/NB	11/5/2011	19050	SECRETARY II	N	SR14	03	T	N	1.00	33,756	1.00	33,756
EDN100/AA	11/5/2011	66574	ELEM TEACHER	Certificated	T03	05	P	A	1.00	57,324	1.00	45,909
EDN150/YC	11/5/2011	800470	SCHOOL PSYCHOLOGIST	Y	SR24	13	P	A	1.00	58,716	1.00	51,312
EDN150/FA	11/9/2011	43646	EDUC ASST III	Y	SR12	03	P	A	1.00	30,506	1.00	29,220
EDN150/YG	11/10/2011	802281	EDUC ASST III	Y	SR12	03	T	A			1.00	25,030
EDN150/YC	11/10/2011	58526	BEHAVIORAL HLTH SPCLT IV	N	SR22	13	T	A	1.00	47,412	1.00	47,412
EDN100/AA	11/11/2011	66738	SECONDARY TEACHER	Certificated	T03	05	P	A	1.00	79,170	1.00	45,909
EDN150/YC	11/14/2011	58369	BEHAVIORAL HLTH SPCLT IV	N	SR22	13	P	A	1.00	45,576	1.00	45,576
EDN400/MD	11/15/2011	41061	CAFETERIA HELPER	N	BC02	01	T	N	0.50	16,614	0.50	16,614
EDN400/MD	11/15/2011	50815	CAFETERIA HELPER	N	BC02	01	T	N	0.50	16,614	0.50	16,614
EDN400/MD	11/15/2011	39560	CAFETERIA HELPER	N	BC02	01	T	N	0.50	16,614	0.50	16,614
EDN400/MD	11/15/2011	42863	CAFETERIA HELPER	N	BC02	01	T	N			0.50	16,614
EDN400/MD	11/15/2011	42893	CAFETERIA HELPER	N	BC02	01	T	N	0.50	16,614	0.50	16,614
EDN400/MD	11/15/2011	46016	CAFETERIA HELPER	N	BC02	01	T	N	0.50	16,614	0.50	16,614
EDN400/MD	11/15/2011	49660	CAFETERIA HELPER	N	BC02	01	T	N	0.50	16,614	0.50	16,614
EDN400/MD	11/15/2011	51599	CAFETERIA HELPER	N	BC02	01	T	N	0.50	16,614	0.50	16,614
EDN400/MD	11/15/2011	49671	CAFETERIA HELPER	N	BC02	01	T	N			0.50	16,614
EDN400/MD	11/15/2011	51598	CAFETERIA HELPER	N	BC02	01	T	N			0.50	16,614
EDN400/MD	11/15/2011	22097	CAFETERIA HELPER	N	BC02	01	T	N	0.50	16,614	0.50	16,614
EDN400/MD	11/15/2011	2075	CAFETERIA HELPER	N	BC02	01	T	N	0.50	16,614	0.50	16,614

Prog ID/Org	Separation Date	Position Number	Position Title	Exempt (Y/N)	SR Level	BU Code	T/P	MOF	Budgeted FTE	Budgeted Salary	Actual FTE	Actual Salary
EDN400/MD	11/15/2011	52940	CAFETERIA HELPER	N	BC02	01	T	N	0.50	16,614	0.50	16,614
EDN400/MD	11/15/2011	800968	CAFETERIA HELPER	N	BC02	01	T	A			0.50	16,614
EDN100/AA	11/15/2011	68103	SECONDARY TEACHER	Certificated	T02	05	P	A	1.00	32,713	1.00	32,222
EDN100/AA	11/16/2011	800749	SCHOOL SECURITY ATTENDANT	N	SR07	03	T	A			0.75	15,405
EDN400/MD	11/16/2011	58620	CAFETERIA HELPER	N	BC02	01	T	N			0.50	16,614
EDN400/MD	11/16/2011	801154	CLERK TYPIST II	N	SR08	03	T	N	1.00	25,668	1.00	25,668
EDN100/AA	11/19/2011	46021	CLERK TYPIST II	N	SR08	03	P	A	0.50	12,834	0.50	12,834
EDN150/NB	11/19/2011	800177	EDUC ASST II	Y	SR10	03	T	N			1.00	23,130
EDN300/KF	11/19/2011	349	PRE AUDIT CLERK III	N	SR15	03	P	A	1.00	33,756	1.00	33,756
EDN150/FA	11/19/2011	74074	SPEC ED TEACHER	Certificated	T03	05	P	A	1.00	33,694	1.00	47,287
EDN150/YG	11/23/2011	800884	EDUC ASST III	Y	SR12	03	P	A	1.00	26,131	1.00	25,030
EDN100/AA	11/24/2011	802295	SCHOOL SECURITY ATTENDANT	N	SR07	03	T	A			1.00	12,798
EDN150/FA	11/24/2011	57163	EDUC ASST III	Y	SR12	03	P	A	0.50	14,684	0.50	14,065
EDN150/YG	11/26/2011	801073	EDUC ASST III	Y	SR12	03	P	A			1.00	30,036
EDN150/YG	11/26/2011	801199	BEHAVIORAL HLTH SPCLT III	N	SR20	13	P	A	1.00	45,576	1.00	42,132
EDN150/FA	11/26/2011	65425	SPEC ED TEACHER	Certificated	T04	05	P	A	1.00	43,157	1.00	50,654
EDN100/AA	11/28/2011	66579	SECONDARY TEACHER	Certificated	T03	05	P	A	1.00	53,483	1.00	48,706
EDN400/MD	11/29/2011	52960	CAFETERIA HELPER	N	BC02	01	T	N	0.50	16,614	0.50	16,614
EDN150/FA	11/29/2011	56132	EDUC ASST III	Y	SR12	03	P	A	0.75	19,599	0.75	17,835
EDN100/AA	11/30/2011	10109	SCHOOL ADM SERVICES ASST III	Certificated	SR16	04	P	A	1.00	37,968	1.00	37,968
EDN100/AA	11/30/2011	600032	SECONDARY TEACHER	Certificated	T02	05	T	A			1.00	43,785
EDN100/AA	12/1/2011	800715	CLERK TYPIST II	N	SR08	03	T	A	0.50	12,834	0.50	12,834
EDN100/AA	12/1/2011	26412	SCHOOL CUSTODIAN II	N	BC02	01	P	A	0.50	16,614	0.50	16,614
EDN100/AA	12/1/2011	48467	SCHOOL CUSTODIAN II	N	BC02	01	P	A	0.50	16,614	0.50	16,614
EDN100/AA	12/1/2011	18678	SCHOOL CUSTODIAN II	N	BC02	01	P	A	0.50	16,614	0.50	16,614
EDN100/AA	12/1/2011	18132	SCHOOL CUSTODIAN II	N	BC02	01	P	A	0.50	16,614	0.50	16,614
EDN150/FA	12/1/2011	57017	EDUC ASST II	Y	SR10	03	T	A	0.75	22,879	0.75	17,348
EDN100/AA	12/1/2011	30669	SCHOOL SECURITY ATTENDANT	N	SR07	03	P	A	1.00	23,229	1.00	22,250
EDN100/CB	12/1/2011	29434	SCHOOL HEALTH AIDE	N	SR09	03	P	A	1.00	24,786	1.00	23,741
EDN150/FA	12/1/2011	52517	EDUC ASST III	Y	SR12	03	P	A	1.00	29,368	1.00	28,130
EDN150/FA	12/1/2011	54677	EDUC ASST III	Y	SR12	03	P	A	1.00	30,506	1.00	29,220
EDN150/FA	12/1/2011	57252	EDUC ASST III	Y	SR12	03	P	A	1.00	30,506	1.00	29,220
EDN100/AA	12/1/2011	16465	SCHOOL CUSTODIAN II	N	BC02	01	P	A	1.00	33,228	1.00	33,228
EDN400/MD	12/1/2011	23124	CAFETERIA HELPER	N	BC02	01	P	A			1.00	33,228
EDN300/KO	12/1/2011	45185	PERSONNEL CLERK V	N	SR13	03	P	A	1.00	42,684	1.00	35,064
EDN400/OC	12/1/2011	24786	CARPENTER I	N	BC09	01	P	A	1.00	48,096	1.00	44,544
EDN150/FB	12/1/2011	60283	SPECIAL SCH TEACHER	Certificated	T03	05	P	A	1.00	43,157	1.00	45,909
EDN400/OC	12/1/2011	17167	ELECTRICIAN I	N	BC10	01	P	A	1.00	49,320	1.00	46,236
EDN150/FA	12/1/2011	73509	SPEC ED TEACHER	Certificated	T03	05	P	A	1.00	49,448	1.00	48,706
EDN100/AA	12/1/2011	68508	SECONDARY TEACHER	Certificated	T03	05	P	A	1.00	49,448	1.00	48,706
EDN100/AA	12/1/2011	63162	SECONDARY TEACHER	Certificated	T03	05	P	A	1.00	53,483	1.00	48,706
EDN150/YC	12/1/2011	800423	SCHOOL PSYCHOLOGIST	Y	SR24	13	P	A	1.00	58,716	1.00	51,312
EDN150/SA	12/1/2011	30408	SPEECH PATHOLOGIST IV	Y	SR22	13	P	A	1.00	66,092	1.00	53,352
EDN150/FA	12/1/2011	68802	SPEC ED TEACHER	Certificated	T04	05	P	A			1.00	53,739
EDN150/FA	12/1/2011	63179	SPEC ED TEACHER	Certificated	T06	05	P	A	1.00	55,622	1.00	54,787

Department of Education
Personnel Separations

Table 15

Prog ID/Org	Separation Date	Position Number	Position Title	Exempt (Y/N)	SR Level	BU Code	T/P	MOF	Budgeted FTE	Budgeted Salary	Actual FTE	Actual Salary
EDN300/KO	12/1/2011	45186	PERSONNEL MGMT SPECIALIST V	N	SR24	13	P	A	1.00	57,708	1.00	57,708
EDN300/KD	12/1/2011	59880	AUDITOR V	N	SR24	13	P	A	1.00	60,024	1.00	60,024
EDN100/BS	12/1/2011	73861	ROTC INSTRUCTOR	Certificated	ROTC	05	T	A	1.00	57,588	1.00	66,727
EDN150/FA	12/1/2011	68748	GEN EDUC/ARTICLE VI TCHR	Certificated	T07	05	P	A	1.00	48,008	1.00	73,567
EDN100/AA	12/2/2011	33123	SCHOOL SECURITY ATTENDANT	N	SR07	03	P	A	1.00	21,444	1.00	20,540
EDN150/SA	12/2/2011	32334	COMMUNICATION AIDE	Y	SR12	03	P	A	1.00	26,131	1.00	25,030
EDN300/KO	12/2/2011	58233	PERSONNEL CLERK III	N	SR09	03	P	A	1.00	31,212	1.00	31,212
EDN150/YC	12/2/2011	58093	SOCIAL WORKER IV	N	SR22	13	P	A	1.00	49,332	1.00	45,576
EDN100/AA	12/8/2011	56015	CLERK III	N	SR08	03	T	A	0.50	13,878	0.50	13,878
EDN100/AA	12/8/2011	55164	CLERK III	N	SR08	03	T	A	0.50	13,878	0.50	13,878
EDN100/BX	12/9/2011	66270	ELEM TEACHER	Certificated	T01	05	P	A	1.00	41,397	1.00	39,746
EDN150/FA	12/10/2011	800562	EDUC ASST II	Y	SR10	03	T	A	0.50	13,066	0.50	11,565
EDN150/FA	12/10/2011	801805	EDUC ASST II	Y	SR10	03	T	A			0.50	11,565
EDN150/FA	12/10/2011	56982	EDUC ASST III	Y	SR12	03	T	A			0.50	12,515
EDN150/FA	12/10/2011	57536	EDUC ASST III	Y	SR12	03	P	A			1.00	25,030
EDN150/FA	12/10/2011	57406	EDUC ASST III	Y	SR12	03	T	A	1.00	26,131	1.00	25,030
EDN100/AA	12/13/2011	74763	SECONDARY TEACHER	Certificated	T03	05	T	A	0.50	24,724	0.50	24,353
EDN300/KO	12/13/2011	8911	SECRETARY II	N	SR14	03	P	A	1.00	35,064	1.00	35,064
EDN100/AA	12/13/2011	71722	SECONDARY TEACHER	Certificated	T06	05	P	A	1.00	48,008	1.00	58,124
EDN150/FA	12/14/2011	67024	SPEC ED TCHR/PRE-SCHOOL	Certificated	T05	05	P	A	1.00	60,195	1.00	59,292
EDN400/MD	12/16/2011	54661	CAFETERIA HELPER	N	BC02	01	T	N			0.50	16,614
EDN150/NB	12/16/2011	801746	EDUC ASST II	Y	SR10	03	T	N			0.75	17,348
EDN150/YG	12/16/2011	801863	EDUC ASST II	Y	SR10	03	T	A			1.00	23,130
EDN100/AA	12/16/2011	801551	EDUC ASST III	Y	SR12	03	T	A			1.00	25,030
EDN100/AA	12/16/2011	59745	ACCOUNT CLERK II	N	SR08	03	T	A			1.00	25,668
EDN100/AA	12/16/2011	66710	ELEM TEACHER	Certificated	T03	05	P	A	1.00	50,743	1.00	45,909
EDN100/AA	12/17/2011	8087	CLERK TYPIST II	N	SR08	03	P	A	1.00	25,668	1.00	25,668
EDN150/FA	12/17/2011	67506	GEN EDUC/ARTICLE VI TCHR	Certificated	T03	05	P	A	1.00	48,008	1.00	47,287
EDN100/AA	12/21/2011	16191	SCHOOL CUSTODIAN II	N	BC02	01	P	A	1.00	33,228	1.00	33,228
EDN100/AA	12/24/2011	40033	ACCOUNT CLERK IV	N	SR13	03	P	A	1.00	31,212	1.00	31,212
EDN150/YC	12/29/2011	32285	SCHOOL PSYCHOLOGIST	Y	SR24	13	P	A	1.00	58,716	1.00	51,312
EDN100/AA	12/31/2011	53183	SCHOOL CUSTODIAN II	N	BC02	01	P	A	0.50	16,614	0.50	16,614
EDN100/AA	12/31/2011	51565	SCHOOL CUSTODIAN II	N	BC02	01	P	A	0.50	16,614	0.50	16,614
EDN100/AA	12/31/2011	16414	SCHOOL CUSTODIAN II	N	BC02	01	P	A	0.50	16,614	0.50	16,614
EDN150/FA	12/31/2011	57575	EDUC ASST I	Y	SR08	03	T	A	0.87	22,865	0.88	18,716
EDN150/FA	12/31/2011	57349	EDUC ASST III	Y	SR12	03	T	A	0.75	19,599	0.75	18,773
EDN100/AA	12/31/2011	602303	ELEM TEACHER	Certificated	T02	05	T	A			0.50	21,893
EDN150/FA	12/31/2011	54989	EDUC ASST III	Y	SR12	03	P	A	0.75	22,879	0.75	21,915
EDN150/FA	12/31/2011	58012	EDUC ASST III	Y	SR12	03	T	A	0.75	23,827	0.75	22,823
EDN150/FA	12/31/2011	47146	EDUC ASST III	Y	SR12	03	P	A	0.87	30,054	0.88	28,787
EDN100/AA	12/31/2011	30643	SCHOOL SECURITY ATTENDANT	N	SR07	03	P	A	1.00	30,506	1.00	29,220
EDN150/FA	12/31/2011	56994	EDUC ASST III	Y	SR12	03	P	A	1.00	30,506	1.00	29,220
EDN150/SA	12/31/2011	30461	COMMUNICATION AIDE	Y	SR12	03	P	A	1.00	30,506	1.00	29,220
EDN200/GN	12/31/2011	5061	CLERK TYPIST II	N	SR08	03	P	A	1.00	30,036	1.00	30,036
EDN150/FA	12/31/2011	52569	EDUC ASST III	Y	SR12	03	P	A	1.00	33,032	1.00	31,640

Prog ID/Org	Separation Date	Position Number	Position Title	Exempt (Y/N)	SR Level	BU Code	T/P	MOF	Budgeted FTE	Budgeted Salary	Actual FTE	Actual Salary
EDN100/AA	12/31/2011	55692	EDUC ASST III	Y	SR12	03	T	A	1.00	34,347	1.00	32,900
EDN150/FA	12/31/2011	28357	EDUC ASST III	Y	SR12	03	P	A	1.00	34,347	1.00	32,900
EDN400/MD	12/31/2011	16337	SCHOOL CUSTODIAN II	N	BC02	01	P	A	1.00	33,228	1.00	33,228
EDN400/OD	12/31/2011	16139	SCHOOL CUSTODIAN II	N	BC02	01	P	A	1.00	33,228	1.00	33,228
EDN100/AA	12/31/2011	16613	SCHOOL CUSTODIAN II	N	BC02	01	P	A	1.00	33,228	1.00	33,228
EDN400/MD	12/31/2011	9432	CAFETERIA HELPER	N	BC02	01	P	A			1.00	33,228
EDN100/AA	12/31/2011	30751	SCHOOL CUSTODIAN II	N	BC02	01	P	A	1.00	33,228	1.00	33,228
EDN100/AA	12/31/2011	16562	SCHOOL CUSTODIAN II	N	BC02	01	P	A	1.00	33,228	1.00	33,228
EDN100/AA	12/31/2011	52485	SCHOOL CUSTODIAN II	N	BC02	01	P	A	1.00	33,228	1.00	33,228
EDN100/AA	12/31/2011	19086	SCHOOL CUSTODIAN II	N	BC02	01	P	A	1.00	33,228	1.00	33,228
EDN100/AA	12/31/2011	33223	CLERK TYPIST II	N	SR08	03	P	A	1.00	33,756	1.00	33,756
EDN400/MD	12/31/2011	9327	FOOD SERVICES DRIVER	N	BC03	01	P	A			1.00	34,164
EDN100/AA	12/31/2011	16224	SCHOOL CUSTODIAN III	N	WS02	01	P	A	1.00	35,544	1.00	35,544
EDN400/OC	12/31/2011	16141	TRACTOR OPERATOR	N	BC04	01	P	A	1.00	37,272	1.00	35,544
EDN400/MD	12/31/2011	12243	SCHOOL COOK II	N	BC06	01	P	A			1.00	38,436
EDN400/MD	12/31/2011	14610	SCHOOL COOK II	N	BC06	01	P	A			1.00	38,436
EDN400/MD	12/31/2011	9898	SCHOOL COOK II	N	BC06	01	P	A			1.00	38,436
EDN400/MD	12/31/2011	15400	SCHOOL COOK II	N	BC06	01	P	A			1.00	38,436
EDN400/MD	12/31/2011	2044	SCHOOL FOOD SERVICES MGR I	N	WF06	02	P	A	1.00	41,048	1.00	39,972
EDN300/KF	12/31/2011	15186	SECRETARY II	N	SR14	03	P	A	1.00	41,040	1.00	41,040
EDN100/AA	12/31/2011	4094	ACCOUNT CLERK IV	N	SR13	03	P	A	1.00	41,040	1.00	41,040
EDN100/AA	12/31/2011	11365	SCHOOL ADM SERVICES ASST III	Certificated	SR16	04	P	A	1.00	44,412	1.00	44,412
EDN400/OC	12/31/2011	43538	BUILDING MAINTENANCE WORKER I	N	BC09	01	P	A	1.00	44,544	1.00	44,544
EDN150/FA	12/31/2011	64548	GEN EDUC/ARTICLE VI TCHR	Certificated	T03	05	P	A			1.00	45,909
EDN150/FA	12/31/2011	74192	SPEC ED TEACHER	Certificated	T03	05	P	A	1.00	46,609	1.00	45,909
EDN400/OC	12/31/2011	17154	PLUMBER I	N	BC10	01	P	A	1.00	49,320	1.00	46,236
EDN400/MD	12/31/2011	38862	SCHOOL FOOD SERVICES MGR III	N	F206	02	P	A	1.00	48,429	1.00	47,160
EDN100/AA	12/31/2011	65772	ELEM TEACHER	Certificated	T03	05	P	A	1.00	48,008	1.00	47,287
EDN100/AA	12/31/2011	63172	ELEM TEACHER	Certificated	T02	05	P	A	1.00	48,574	1.00	47,845
EDN100/AA	12/31/2011	600220	SECONDARY TEACHER	Certificated	T03	05	T	A			1.00	48,706
EDN100/AA	12/31/2011	2534	SCHOOL ADM SERVICES ASST III	Certificated	SR16	04	P	A	1.00	49,932	1.00	49,932
EDN400/MD	12/31/2011	12532	SCHOOL FOOD SERVICES MGR III	N	F206	02	P	A	1.00	51,387	1.00	50,040
EDN200/GN	12/31/2011	57974	ADMINISTRATIVE SERVICES ASST	N	SR22	13	P	A	1.00	51,312	1.00	51,312
EDN150/NB	12/31/2011	56129	SCHOOL PSYCHOLOGIST	Y	SR24	13	T	N			1.00	51,312
EDN100/AA	12/31/2011	7807	SCHOOL ADM SERVICES ASST III	Certificated	SR16	04	P	A	1.00	54,012	1.00	54,012
EDN100/AA	12/31/2011	23046	SCHOOL ADM SERVICES ASST IV	Certificated	SR18	04	P	A	1.00	54,012	1.00	54,012
EDN100/AA	12/31/2011	63534	12-MONTH SAC TEACHER	Certificated	T05	05	P	A	1.00	66,104	1.00	54,260
EDN150/SA	12/31/2011	50479	SOCIAL WORKER IV	N	SR22	13	P	A	1.00	56,994	1.00	55,500
EDN150/FA	12/31/2011	75764	GEN EDUC/ARTICLE VI TCHR	Certificated	T07	05	T	A	1.00	58,959	1.00	58,074
EDN100/AA	12/31/2011	60881	ELEM TEACHER	Certificated	T04	05	P	A	1.00	60,662	1.00	58,722
EDN100/AA	12/31/2011	73831	12-MONTH REGISTRAR	Certificated	T05	05	P	A	1.00	72,234	1.00	59,292
EDN100/AA	12/31/2011	76320	SECONDARY TEACHER	Certificated	T07	05	P	A	1.00	60,730	1.00	59,818
EDN150/SA	12/31/2011	27649	SOCIAL WORKER IV	N	SR22	13	P	A	1.00	61,640	1.00	60,024
EDN400/MB	12/31/2011	9887	SCHOOL LUNCH SERVICES SUPVR	N	SR24	13	P	A	1.00	60,024	1.00	60,024
EDN150/FA	12/31/2011	74173	SPEC ED TEACHER	Certificated	T07	05	P	A	1.00	48,008	1.00	61,611

<u>Prog ID/Org</u>	<u>Separation Date</u>	<u>Position Number</u>	<u>Position Title</u>	<u>Exempt (Y/N)</u>	<u>SR Level</u>	<u>BU Code</u>	<u>T/P</u>	<u>MOF</u>	<u>Budgeted FTE</u>	<u>Budgeted Salary</u>	<u>Actual FTE</u>	<u>Actual Salary</u>
EDN100/AA	12/31/2011	73164	LIBRARIAN	Certificated	T07	05	P	A	1.00	65,722	1.00	63,460
EDN100/AA	12/31/2011	60889	ELEM TEACHER	Certificated	T06	05	P	A	1.00	65,527	1.00	63,514
EDN150/FA	12/31/2011	62153	SPEC ED TEACHER	Certificated	T05	05	P	A	1.00	65,778	1.00	64,791
EDN100/AA	12/31/2011	61256	ELEM TEACHER	Certificated	T07	05	P	A	1.00	66,359	1.00	65,363
EDN100/AA	12/31/2011	71735	ELEM TEACHER	Certificated	T07	05	P	A	1.00	68,351	1.00	67,325
EDN100/BJ	12/31/2011	74261	SECONDARY TEACHER	Certificated	T07	05	P	A	1.00	68,351	1.00	67,325
EDN100/AA	12/31/2011	69631	SECONDARY TEACHER	Certificated	T07	05	P	A	1.00	68,351	1.00	67,325
EDN100/AA	12/31/2011	66140	SECONDARY TEACHER	Certificated	T07	05	P	A	1.00	68,351	1.00	67,325
EDN100/AA	12/31/2011	60484	ELEM TEACHER	Certificated	T07	05	P	A	1.00	69,396	1.00	67,325
EDN100/AA	12/31/2011	62086	SECONDARY TEACHER	Certificated	T07	05	P	A	1.00	68,351	1.00	67,325
EDN100/BB	12/31/2011	63065	SECONDARY TEACHER	Certificated	T07	05	P	A	1.00	54,528	1.00	67,325
EDN100/AA	12/31/2011	71811	SECONDARY TEACHER	Certificated	T07	05	P	A	1.00	68,351	1.00	67,325
EDN100/AA	12/31/2011	60365	SECONDARY TEACHER	Certificated	T07	05	P	A	1.00	68,351	1.00	67,325
EDN150/FA	12/31/2011	73212	SPEC ED TEACHER	Certificated	T07	05	P	A	1.00	68,351	1.00	67,325
EDN200/GN	12/31/2011	73565	COMPLEX AREA TEACHER	Certificated	T07	05	T	A	1.00	68,351	1.00	67,325
EDN100/AA	12/31/2011	62033	SECONDARY TEACHER	Certificated	T07	05	P	A	1.00	68,351	1.00	67,325
EDN100/AA	12/31/2011	69670	ELEM TEACHER	Certificated	T07	05	P	A	1.00	69,646	1.00	67,325
EDN100/AA	12/31/2011	63005	COUNSELOR	Certificated	T06	05	P	A	1.00	68,408	1.00	67,381
EDN100/AA	12/31/2011	63067	SECONDARY TEACHER	Certificated	T04	05	P	A	1.00	70,349	1.00	68,018
EDN100/AA	12/31/2011	61112	ELEM TEACHER	Certificated	T07	05	P	A	1.00	70,400	1.00	69,344
EDN150/FA	12/31/2011	62719	SPEC ED TEACHER	Certificated	T07	05	P	A	1.00	70,400	1.00	69,344
EDN100/AA	12/31/2011	68414	SECONDARY TEACHER	Certificated	T07	05	P	A	1.00	70,400	1.00	69,344
EDN100/AA	12/31/2011	63054	SECONDARY TEACHER	Certificated	T07	05	P	A	1.00	70,400	1.00	69,344
EDN100/AA	12/31/2011	69055	COUNSELOR	Certificated	T07	05	P	A	1.00	70,400	1.00	69,344
EDN100/AA	12/31/2011	600250	12-MO SECONDARY TEACHER	Certificated	T07	05	T	A			1.00	69,344
EDN100/AA	12/31/2011	63800	SECONDARY TEACHER	Certificated	T06	05	P	A	1.00	70,461	1.00	69,404
EDN100/AA	12/31/2011	65079	ELEM TEACHER	Certificated	T07	05	P	A	1.00	72,513	1.00	71,425
EDN100/AA	12/31/2011	61584	ELEM TEACHER	Certificated	T07	05	P	A	1.00	73,808	1.00	71,425
EDN100/AA	12/31/2011	67324	ELEM TEACHER	Certificated	T07	05	P	A	1.00	72,513	1.00	71,425
EDN100/AA	12/31/2011	601023	ELEM TEACHER	Certificated	T07	05	T	A			1.00	71,425
EDN100/AA	12/31/2011	68810	SECONDARY TEACHER	Certificated	T07	05	P	A	1.00	72,513	1.00	71,425
EDN100/BS	12/31/2011	73492	ROTC INSTRUCTOR	Certificated	ROTC	05	T	A	1.00	65,796	1.00	73,560
EDN100/AA	12/31/2011	66534	SECONDARY TEACHER	Certificated	T07	05	P	A	1.00	74,688	1.00	73,567
EDN100/AA	12/31/2011	62447	ELEM TEACHER	Certificated	T07	05	P	A	1.00	75,983	1.00	73,567
EDN100/AA	12/31/2011	601486	COUNSELOR	Certificated	T07	05	T	A			1.00	73,567
EDN100/AA	12/31/2011	75229	12-MO STUDENT SVCS COORD	Certificated	T07	05	T	A			1.00	73,567
EDN150/FA	12/31/2011	61823	SPEC ED TEACHER	Certificated	T06	05	P	A	1.00	74,688	1.00	73,567
EDN100/BJ	12/31/2011	68095	SECONDARY TEACHER	Certificated	T07	05	P	A	1.00	74,688	1.00	73,567
EDN100/AA	12/31/2011	63061	SCH ATHLETIC DIR III	Certificated	E03	06	P	A	1.00	73,921	1.00	73,921
EDN100/AA	12/31/2011	68876	SECONDARY TEACHER	Certificated	T07	05	P	A	1.00	79,170	1.00	77,982
EDN150/FA	12/31/2011	69128	SPEC ED TEACHER	Certificated	T07	05	P	A	1.00	79,170	1.00	77,982
EDN100/AA	12/31/2011	72071	12-MO STUDENT SVCS COORD	Certificated	T07	05	T	A	1.00	95,004	1.00	77,982
EDN100/AA	12/31/2011	68018	SECONDARY TEACHER	Certificated	T07	05	P	A	1.00	79,170	1.00	77,982
EDN100/AA	12/31/2011	74169	ELEM TEACHER	Certificated	T07	05	P	A	1.00	80,465	1.00	77,982
EDN200/GN	12/31/2011	69964	COMPLEX AREA TEACHER	Certificated	T07	05	P	A	1.00	68,351	1.00	77,982

Department of Education
Personnel Separations

Table 15

Prog ID/Org	Separation Date	Position Number	Position Title	Exempt (Y/N)	SR Level	BU Code	T/P	MOF	Budgeted FTE	Budgeted Salary	Actual FTE	Actual Salary
EDN100/AA	12/31/2011	74454	SECONDARY TEACHER	Certificated	T07	05	P	A	1.00	79,170	1.00	77,982
EDN100/AA	12/31/2011	65667	LIBRARIAN	Certificated	T07	05	P	A	1.00	80,465	1.00	77,982
EDN100/AA	12/31/2011	63030	SECONDARY TEACHER	Certificated	T07	05	P	A	1.00	79,170	1.00	77,982
EDN500/PC	12/31/2011	67700	12-MONTH REGISTRAR	Certificated	T07	05	P	A	1.00	95,004	1.00	77,982
EDN100/AA	12/31/2011	68664	ELEM TEACHER	Certificated	T07	05	P	A	1.00	79,170	1.00	77,982
EDN100/AA	12/31/2011	66552	ELEM TEACHER	Certificated	T07	05	P	A	1.00	79,170	1.00	77,982
EDN100/AA	12/31/2011	65874	SECONDARY TEACHER	Certificated	T07	05	P	A	1.00	79,170	1.00	77,982
EDN100/AA	12/31/2011	601081	SPEC ED TEACHER	Certificated	T07	05	T	A			1.00	77,982
EDN100/AA	12/31/2011	61702	SECONDARY TEACHER	Certificated	T07	05	P	A	1.00	79,170	1.00	77,982
EDN100/AA	12/31/2011	72739	SECONDARY TEACHER	Certificated	T07	05	P	A	0.50	39,585	1.00	77,982
EDN150/NB	12/31/2011	79839	DIST OFF TCHR	Certificated	T07	05	T	N			1.00	77,982
EDN100/AA	12/31/2011	66723	SECONDARY TEACHER	Certificated	T07	05	P	A	1.00	32,713	1.00	77,982
EDN100/AA	12/31/2011	61414	LIBRARIAN	Certificated	T07	05	P	A	1.00	80,465	1.00	77,982
EDN100/AA	12/31/2011	68141	SCH ATHLETIC DIR III	Certificated	E03	06	P	A	1.00	79,242	1.00	79,242
EDN100/AA	12/31/2011	69299	SCH ATHLETIC DIR III	Certificated	E03	06	P	A	1.00	79,242	1.00	79,242
EDN400/OC	12/31/2011	800726	GEN PROF VI	N	SR26	13	P	A	1.00	82,128	1.00	82,128
EDN200/GN	12/31/2011	76349	DISTRICT EDUC SPEC II	Certificated	E07	06	T	A			1.00	87,340
EDN100/BS	12/31/2011	73393	ROTC INSTRUCTOR	Certificated	ROTC	05	T	A	1.00	86,568	1.00	99,714
EDN100/BS	12/31/2011	73414	ROTC INSTRUCTOR	Certificated	ROTC	05	T	A	1.00	86,628	1.00	99,876
EDN400/OC	12/31/2011	60110	BUDGET SPECIALIST II	Certificated	E07	06	P	A	1.00	103,196	1.00	103,196
EDN300/KO	12/31/2011	68467	PERS REGIONAL OFFICER II	Certificated	E07	06	P	A	1.00	109,099	1.00	109,099
EDN200/GJ	12/31/2011	73061	EDUCATIONAL SPEC III	Certificated	E08	06	P	A	1.00	110,626	1.00	110,626
EDN100/AA	12/31/2011	66778	12-MO ELEM PRIN III	Certificated	E07	06	P	A	1.00	126,460	1.00	126,460
EDN100/AA	12/31/2011	61854	12-MO ELEM PRIN II	Certificated	E06	06	P	A	1.00	126,460	1.00	126,460
EDN100/AA	12/31/2011	68657	12-MO ELEM PRIN III	Certificated	E07	06	P	A	1.00	130,023	1.00	130,023
EDN100/AA	1/3/2012	54850	CLERK III	N	SR08	03	T	A	0.50	15,018	0.50	15,018
EDN100/AA	1/3/2012	602446	ELEM TEACHER	Certificated	T03	05	T	A			0.50	22,955
EDN150/FA	1/3/2012	63289	SPEC ED TEACHER	Certificated	T02	05	P	A	1.00	56,917	1.00	42,509
EDN100/AA	1/3/2012	53296	SCHOOL ADM SERVICES ASST III	Certificated	SR16	04	P	A	1.00	44,412	1.00	44,412
EDN100/AA	1/3/2012	68899	SECONDARY TEACHER	Certificated	T03	05	P	A	1.00	52,471	1.00	45,909
EDN100/AA	1/3/2012	602352	ELEM TEACHER	Certificated	T03	05	T	A			1.00	45,909
EDN100/AA	1/3/2012	65429	SECONDARY TEACHER	Certificated	T03	05	P	A	1.00	50,493	1.00	45,909
EDN100/AA	1/3/2012	66004	ELEM TEACHER	Certificated	T03	05	P	A	1.00	58,959	1.00	47,287
EDN100/AA	1/3/2012	66768	SECONDARY TEACHER	Certificated	T03	05	P	A	1.00	49,448	1.00	48,706
EDN150/YG	1/3/2012	75418	12-MO DIST OFF TCHR	Certificated	T04	05	T	A	1.00	57,610	1.00	50,654
EDN100/AA	1/3/2012	69555	SECONDARY TEACHER	Certificated	T05	05	T	A	1.00	51,426	1.00	52,680
EDN100/AA	1/3/2012	600804	SECONDARY TEACHER	Certificated	T05	05	T	A			1.00	55,888
EDN150/FA	1/4/2012	57176	EDUC ASST II	Y	SR10	03	T	A			1.00	23,130
EDN150/YG	1/4/2012	800269	EDUC ASST II	Y	SR10	03	P	A	1.00	26,131	1.00	23,130
EDN100/AA	1/4/2012	600288	ELEM TEACHER	Certificated	T03	05	T	A			0.50	23,643
EDN150/FA	1/4/2012	800084	EDUC ASST III	Y	SR12	03	T	A			1.00	25,030
EDN150/YG	1/4/2012	800883	EDUC ASST III	Y	SR12	03	P	A	1.00	26,131	1.00	25,030
EDN200/GN	1/4/2012	51186	ACCOUNT CLERK II	N	SR08	03	P	A	1.00	37,968	1.00	26,700
EDN400/OC	1/4/2012	17063	CLERK TYPIST III	N	SR10	03	P	A	1.00	28,836	1.00	28,836
EDN150/FA	1/4/2012	60984	SPEC ED TEACHER	Certificated	T02	05	P	A	1.00	49,448	1.00	32,222

Prog ID/Org	Separation Date	Position Number	Position Title	Exempt (Y/N)	SR Level	BU Code	T/P	MOF	Budgeted FTE	Budgeted Salary	Actual FTE	Actual Salary
EDN150/FA	1/4/2012	601948	GEN EDUC/ARTICLE VI TCHR	Certificated	T02	05	T	A			1.00	32,222
EDN150/FA	1/4/2012	76151	SPEC ED TEACHER	Certificated	T02	05	T	A	1.00	49,448	1.00	32,222
EDN100/AA	1/4/2012	68182	SECONDARY TEACHER	Certificated	T02	05	P	A	1.00	49,448	1.00	32,222
EDN150/SA	1/4/2012	801329	EDUCATIONAL INTERPRETER II	N	SR14	03	P	A	1.00	32,424	1.00	32,424
EDN100/AA	1/4/2012	66805	SECONDARY TEACHER	Certificated	T03	05	P	A	1.00	35,329	1.00	34,799
EDN100/AA	1/4/2012	62902	SECONDARY TEACHER	Certificated	T02	05	P	A	1.00	49,448	1.00	39,958
EDN200/GN	1/4/2012	1818	PRIVATE SECRETARY I	N	SR20	03	P	A	1.00	44,412	1.00	41,040
EDN150/FA	1/4/2012	76149	GEN EDUC/ARTICLE VI TCHR	Certificated	T02	05	P	A	1.00	43,157	1.00	42,509
EDN150/FA	1/4/2012	64291	GEN EDUC/ARTICLE VI TCHR	Certificated	T02	05	P	A			1.00	42,509
EDN150/FA	1/4/2012	75596	GEN EDUC/ARTICLE VI TCHR	Certificated	T02	05	T	A	1.00	43,157	1.00	42,509
EDN150/FA	1/4/2012	63913	GEN EDUC/ARTICLE VI TCHR	Certificated	T02	05	P	A	1.00	43,157	1.00	42,509
EDN100/AA	1/4/2012	69195	SECONDARY TEACHER	Certificated	T02	05	P	A	1.00	43,157	1.00	42,509
EDN150/FA	1/4/2012	63955	GEN EDUC/ARTICLE VI TCHR	Certificated	T02	05	P	A	1.00	46,609	1.00	45,098
EDN150/FA	1/4/2012	62808	SPEC ED TEACHER	Certificated	T02	05	P	A	1.00	64,482	1.00	45,098
EDN150/YC	1/4/2012	58349	BEHAVIORAL HLTH SPCLT IV	N	SR22	13	P	A	1.00	45,576	1.00	45,576
EDN150/FA	1/4/2012	74380	SPEC ED TEACHER	Certificated	T03	05	P	A	1.00	50,493	1.00	45,909
EDN150/FA	1/4/2012	67672	SPEC ED TEACHER	Certificated	T03	05	P	A	1.00	53,483	1.00	45,909
EDN150/FA	1/4/2012	62415	SPEC ED TEACHER	Certificated	T03	05	P	A	1.00	43,157	1.00	45,909
EDN150/FA	1/4/2012	74080	SPEC ED TEACHER	Certificated	T03	05	P	A	1.00	79,170	1.00	45,909
EDN100/AA	1/4/2012	63787	SECONDARY TEACHER	Certificated	T03	05	P	A	1.00	45,785	1.00	45,909
EDN100/AA	1/4/2012	64804	SECONDARY TEACHER	Certificated	T03	05	P	A	1.00	74,688	1.00	45,909
EDN100/AA	1/4/2012	69064	ELEM TEACHER	Certificated	T03	05	P	A	1.00	66,359	1.00	47,287
EDN150/FA	1/4/2012	60197	SPEC ED TEACHER	Certificated	T03	05	P	A	1.00	32,713	1.00	47,287
EDN150/NB	1/4/2012	79242	DIST OFF TCHR	Certificated	T03	05	T	N			1.00	47,287
EDN150/YC	1/4/2012	58631	BEHAVIORAL HLTH SPCLT IV	N	SR22	13	P	A	1.00	45,576	1.00	47,412
EDN100/AA	1/4/2012	68683	SECONDARY TEACHER	Certificated	T04	05	P	A	1.00	40,567	1.00	47,746
EDN100/AA	1/4/2012	60612	SECONDARY TEACHER	Certificated	T03	05	P	A	1.00	45,785	1.00	48,706
EDN100/AA	1/4/2012	64594	SECONDARY TEACHER	Certificated	T06	05	P	A	1.00	56,917	1.00	54,787
EDN400/OC	1/4/2012	34313	ENGINEER V	N	SR26	13	P	A	1.00	70,178	1.00	55,500
EDN150/YC	1/4/2012	59733	CLINICAL PSYCHOLOGIST VI	N	SR26	13	T	A	1.00	66,024	1.00	55,500
EDN100/AA	1/4/2012	61463	ELEM TEACHER	Certificated	T06	05	T	A	1.00	43,157	1.00	56,431
EDN100/AA	1/5/2012	59731	SCHOOL SECURITY ATTENDANT	N	SR07	03	T	A	0.50	10,722	0.50	10,270
EDN100/AA	1/5/2012	55850	EDUC ASST III	Y	SR12	03	P	A	0.50	13,066	0.50	12,515
EDN100/AA	1/5/2012	29485	SCHOOL HEALTH AIDE	N	SR09	03	P	A	1.00	22,919	1.00	21,953
EDN100/AA	1/6/2012	30598	SCHOOL SECURITY ATTENDANT	N	SR07	03	P	A	1.00	22,331	1.00	21,390
EDN100/AA	1/7/2012	56616	CLERK TYPIST II	N	SR08	03	P	A	0.50	12,834	0.50	12,834
EDN100/AA	1/7/2012	29517	SCHOOL HEALTH AIDE	N	SR09	03	P	A	1.00	18,873	1.00	22,250
EDN100/AA	1/7/2012	601468	LIBRARIAN	Certificated	T03	05	T	A			0.50	24,353
EDN150/FA	1/7/2012	47129	EDUC ASST III	Y	SR12	03	P	A	1.00	26,131	1.00	25,030
EDN150/YG	1/7/2012	801521	EDUC ASST III	Y	SR12	03	T	A			1.00	25,030
EDN150/YG	1/7/2012	801833	EDUC ASST III	Y	SR12	03	T	A			1.00	30,036
EDN100/AA	1/7/2012	1905	SCHOOL ADM SERVICES ASST III	Certificated	SR16	04	P	A	1.00	44,412	1.00	44,412
EDN100/AA	1/7/2012	72226	SECONDARY TEACHER	Certificated	T03	05	P	A	1.00	46,609	1.00	45,909
EDN100/AA	1/7/2012	600281	COUNSELOR	Certificated	T07	05	T	A			1.00	67,325
EDN150/YC	1/11/2012	58650	BEHAVIORAL SPECIALIST III	N	SR20	13	T	A	1.00	49,332	1.00	42,132

Department of Education
Personnel Separations

Table 15

<u>Prog ID/Org</u>	<u>Separation Date</u>	<u>Position Number</u>	<u>Position Title</u>	<u>Exempt (Y/N)</u>	<u>SR Level</u>	<u>BU Code</u>	<u>T/P</u>	<u>MOF</u>	<u>Budgeted FTE</u>	<u>Budgeted Salary</u>	<u>Actual FTE</u>	<u>Actual Salary</u>
EDN100/AA	1/11/2012	69916	SECONDARY TEACHER	Certificated	T04	05	P	A	1.00	51,426	1.00	50,654
EDN150/FA	1/13/2012	57603	EDUC ASST II	Y	SR10	03	P	A	0.75	19,599	0.75	17,348
EDN150/YC	1/13/2012	58297	CLINICAL PSYCHOLOGIST VI	N	SR26	13	P	A	1.00	66,024	1.00	55,500
EDN100/AA	1/14/2012	56444	CLERK TYPIST II	N	SR08	03	P	A	0.50	12,834	1.00	25,668
EDN100/CN	1/14/2012	59815	PERSONNEL CLERK IV	N	SR11	03	T	N			1.00	28,836
EDN100/AA	1/14/2012	62152	ELEM TEACHER	Certificated	T02	05	P	A	1.00	60,729	1.00	42,509
EDN100/AA	1/14/2012	62268	SECONDARY TEACHER	Certificated	T03	05	P	A	1.00	74,688	1.00	47,287
EDN100/AA	1/17/2012	63240	SECONDARY TEACHER	Certificated	T02	05	P	A	1.00	68,351	1.00	42,509
EDN150/FA	1/18/2012	37289	EDUC ASST III	Y	SR12	03	P	A	1.00	28,209	1.00	25,030
EDN150/FA	1/18/2012	801953	EDUC ASST III	Y	SR12	03	T	A			1.00	25,030
EDN100/AA	1/18/2012	55366	CLERK III	N	SR08	03	P	A	1.00	27,756	1.00	27,756
EDN150/YC	1/18/2012	58542	BEHAVIORAL HLTH SPCLT III	N	SR20	13	T	A	1.00	45,576	1.00	42,132
EDN150/FA	1/18/2012	65735	SPEC ED TEACHER	Certificated	T02	05	P	A	1.00	45,785	1.00	45,098
EDN100/AA	1/19/2012	800735	SCHOOL CUSTODIAN II	N	BC02	01	P	A			0.50	16,614
EDN100/AA	1/19/2012	800736	SCHOOL SECURITY ATTENDANT	N	SR07	03	T	A			1.00	20,540
EDN100/DB	1/20/2012	801103	PERSONNEL CLERK V	N	SR13	03	T	N			1.00	16,211
EDN150/FA	1/20/2012	65121	SPEC ED TEACHER	Certificated	T02	05	P	A	1.00	45,785	1.00	43,785
EDN150/FA	1/20/2012	74909	SPEC ED TEACHER	Certificated	T02	05	P	A	1.00	46,609	1.00	45,098
EDN100/AA	1/20/2012	65391	ELEM TEACHER	Certificated	T03	05	P	A	1.00	48,008	1.00	47,287
EDN150/FA	1/21/2012	56910	EDUC ASST I	Y	SR08	03	P	A	0.50	13,066	0.50	10,695
EDN150/YG	1/21/2012	801831	EDUC ASST I	Y	SR08	03	T	A			1.00	13,327
EDN150/FA	1/21/2012	801903	EDUC ASST III	Y	SR12	03	P	A			0.75	18,773
EDN150/NB	1/21/2012	801772	EDUC ASST III	Y	SR12	03	T	N			0.75	18,773
EDN400/MB	1/21/2012	801150	CLERK TYPIST II	N	SR08	03	T	B			1.00	25,668
EDN150/FA	1/21/2012	601294	SPEC ED TEACHER	Certificated	T02	05	T	A			1.00	42,509
EDN100/AA	1/21/2012	65205	ELEM TEACHER	Certificated	T03	05	P	A	1.00	62,550	1.00	45,909
EDN150/FA	1/21/2012	60726	SPEC ED TEACHER	Certificated	T03	05	P	A	1.00	33,694	1.00	50,167
EDN150/FA	1/24/2012	52576	EDUC ASST III	Y	SR12	03	P	A	1.00	30,506	1.00	29,220
EDN100/AA	1/24/2012	73935	SECONDARY TEACHER	Certificated	T02	05	T	A	1.00	79,170	1.00	43,785
EDN150/FA	1/25/2012	30755	EDUC ASST II	Y	SR10	03	P	A	1.00	35,705	1.00	23,130
EDN150/FA	1/25/2012	67192	SPEC ED TEACHER	Certificated	T03	05	P	A	1.00	56,740	1.00	45,909
EDN150/FA	1/26/2012	66221	SPEC ED TEACHER	Certificated	T03	05	P	A	1.00	49,448	1.00	48,706
EDN100/AA	1/26/2012	601556	VICE PRINCIPAL I	Certificated	E03	06	T	A			1.00	63,568
EDN150/FA	1/27/2012	800538	EDUC ASST III	Y	SR12	03	P	A	1.00	29,368	1.00	28,130
EDN100/AA	1/27/2012	63976	ELEM TEACHER	Certificated	T02	05	P	A	1.00	45,785	1.00	45,098
EDN100/AA	1/27/2012	69876	ELEM TEACHER	Certificated	T03	05	P	A	1.00	49,448	1.00	47,287
EDN100/AA	1/28/2012	59965	CLERK TYPIST II	N	SR08	03	T	A	0.50	13,350	0.50	13,350
EDN200/GN	1/28/2012	57935	PROFESSIONAL TRAINEE II	N	SR18	13	P	A	1.00	45,576	1.00	38,988
EDN150/FA	1/28/2012	66578	SPEC ED TEACHER	Certificated	T05	05	P	A	1.00	49,448	1.00	52,680
EDN150/YC	1/28/2012	58513	BEHAVIORAL HLTH SPCLT IV	N	SR22	13	P	A	1.00	55,500	1.00	55,500
EDN100/AA	1/31/2012	62789	ELEM TEACHER	Certificated	T03	05	P	A	1.00	32,713	1.00	45,909
EDN100/AA	2/1/2012	800698	CLERK II	N	SR06	03	P	A	0.50	11,844	0.50	11,844
EDN150/NB	2/1/2012	59684	CLERK II	N	SR06	03	T	N			0.50	12,834
EDN100/AA	2/1/2012	32283	SCHOOL CUSTODIAN II	N	BC02	01	P	A	0.50	16,614	0.50	16,614
EDN100/AA	2/1/2012	14715	CLERK TYPIST II	N	SR08	03	P	A	0.50	17,532	0.50	17,532

Prog ID/Org	Separation Date	Position Number	Position Title	Exempt (Y/N)	SR Level	BU Code	T/P	MOF	Budgeted FTE	Budgeted Salary	Actual FTE	Actual Salary
EDN100/AA	2/1/2012	29417	SCHOOL HEALTH AIDE	N	SR09	03	P	A	1.00	19,620	1.00	18,793
EDN150/FA	2/1/2012	800659	EDUC ASST III	Y	SR12	03	P	A			1.00	25,030
EDN150/FA	2/1/2012	56866	EDUC ASST III	Y	SR12	03	T	A	1.00	29,368	1.00	28,130
EDN150/SA	2/1/2012	32221	COMMUNICATION AIDE	Y	SR12	03	P	A	1.00	30,506	1.00	29,220
EDN100/AA	2/1/2012	27202	CLERK TYPIST II	N	SR08	03	P	A	1.00	30,036	1.00	30,036
EDN150/FA	2/1/2012	43256	EDUC ASST III	Y	SR12	03	P	A	1.00	31,769	1.00	30,430
EDN100/DB	2/1/2012	801056	PERSONNEL CLERK V	N	SR13	03	T	N			1.00	31,212
EDN100/AA	2/1/2012	14697	LIBRARY ASSISTANT III	N	SR07	03	P	A	1.00	32,424	1.00	32,424
EDN100/AA	2/1/2012	23246	EDUC ASST III	Y	SR12	03	P	A	1.00	34,347	1.00	32,900
EDN100/AA	2/1/2012	44137	SCHOOL CUSTODIAN II	N	BC02	01	P	A	1.00	33,228	1.00	33,228
EDN100/AA	2/1/2012	16405	SCHOOL CUSTODIAN III	N	WS02	01	P	A	1.00	35,544	1.00	35,544
EDN150/SA	2/1/2012	56278	SPEECH PATHOLOGIST III	Y	SR20	13	P	A	1.00	58,563	1.00	42,132
EDN100/AA	2/1/2012	63524	SECONDARY TEACHER	Certificated	T02	05	P	A	1.00	58,959	1.00	42,509
EDN150/YG	2/1/2012	801355	HUMAN SVCS PROF IV	N	SR22	13	P	A			1.00	45,576
EDN100/AA	2/1/2012	601362	ELEM TEACHER	Certificated	T03	05	T	A			1.00	47,287
EDN150/YC	2/1/2012	58382	BEHAVIORAL SPECIALIST IV	N	SR22	13	P	A	1.00	49,332	1.00	49,332
EDN100/AA	2/1/2012	60622	ELEM TEACHER	Certificated	T04	05	P	A	1.00	54,558	1.00	53,739
EDN100/AA	2/1/2012	600439	SECONDARY TEACHER	Certificated	T04	05	T	A			1.00	55,352
EDN500/PC	2/1/2012	42779	SCHOOL ADM SERVICES ASST IV	Certificated	SR18	04	P	A	1.00	58,440	1.00	58,440
EDN200/GD	2/1/2012	60035	EDUCATIONAL SPEC III	Certificated	E08	06	P	A	1.00	-	1.00	96,267
EDN100/AA	2/2/2012	59843	LIBRARY ASSISTANT III	N	SR07	03	P	A	1.00	26,700	1.00	24,648
EDN150/YG	2/2/2012	800792	EDUC ASST III	Y	SR12	03	P	A	1.00	30,506	1.00	29,220
EDN100/AA	2/4/2012	38891	CLERK TYPIST II	N	SR08	03	P	A	0.50	12,834	0.50	12,834
EDN100/AA	2/4/2012	55169	CLERK III	N	SR08	03	T	A	0.50	13,878	0.50	13,878
EDN400/MD	2/4/2012	35934	CAFETERIA HELPER	N	BC02	01	P	A			0.50	16,614
EDN150/FA	2/4/2012	58883	EDUC ASST III	Y	SR12	03	T	A	0.75	19,599	0.75	18,773
EDN150/FA	2/4/2012	66643	SPEC ED TEACHER	Certificated	T03	05	P	A	1.00	48,008	1.00	45,909
EDN300/KO	2/4/2012	59122	PERSONNEL MGMT SPECIALIST V	N	SR24	13	P	A	1.00	53,352	1.00	53,352
EDN300/UA	2/4/2012	66816	INFO TECH TRG SPEC II	Certificated	E07	06	P	A	1.00	80,350	1.00	80,350
EDN150/FA	2/7/2012	56912	EDUC ASST III	Y	SR12	03	P	A	1.00	30,506	1.00	29,220
EDN100/AA	2/7/2012	16720	SCHOOL CUSTODIAN II	N	BC02	01	P	A	1.00	33,228	1.00	33,228
EDN100/AA	2/8/2012	55673	EDUC ASST III	Y	SR12	03	P	A	1.00	26,131	1.00	25,030
EDN150/YC	2/9/2012	58414	BEHAVIORAL HLTH SPCLT III	N	SR20	13	P	A	1.00	47,412	1.00	43,824
EDN100/CB	2/10/2012	49551	SCHOOL HEALTH AIDE	N	SR09	03	P	A	1.00	26,838	1.00	25,707
EDN150/YG	2/11/2012	801874	EDUC ASST II	Y	SR10	03	T	A			1.00	23,130
EDN150/FA	2/11/2012	57162	EDUC ASST III	Y	SR12	03	P	A	1.00	30,506	1.00	29,220
EDN200/GN	2/11/2012	3909	SECRETARY II	N	SR14	03	P	A	1.00	39,480	1.00	39,480
EDN150/FA	2/13/2012	802344	EDUC ASST III	Y	SR12	03	T	A			1.00	25,030
EDN100/DB	2/14/2012	801231	CLERK TYPIST II	N	SR08	03	T	N			0.50	6,664
EDN150/FA	2/14/2012	57265	EDUC ASST III	Y	SR12	03	T	A	0.75	20,366	0.75	19,508
EDN100/AA	2/14/2012	602396	SECONDARY TEACHER	Certificated	T03	05	T	A			1.00	45,909
EDN150/FA	2/14/2012	63195	SPEC ED TEACHER	Certificated	T04	05	P	A	1.00	48,008	1.00	49,179
EDN100/AA	2/15/2012	801582	EDUC ASST III	Y	SR12	03	T	A			1.00	25,030
EDN100/AA	2/15/2012	30750	SCHOOL CUSTODIAN II	N	BC02	01	P	A	1.00	33,228	1.00	33,228
EDN150/FA	2/17/2012	76159	SPEC ED TEACHER	Certificated	T02	05	P	A	1.00	45,785	1.00	45,098

Department of Education
Personnel Separations

Table 15

<u>Prog ID/Org</u>	<u>Separation Date</u>	<u>Position Number</u>	<u>Position Title</u>	<u>Exempt (Y/N)</u>	<u>SR Level</u>	<u>BU Code</u>	<u>T/P</u>	<u>MOF</u>	<u>Budgeted FTE</u>	<u>Budgeted Salary</u>	<u>Actual FTE</u>	<u>Actual Salary</u>
EDN150/YC	2/17/2012	58653	BEHAVIORAL HLTH SPCLT IV	N	SR22	13	P	A	1.00	47,412	1.00	47,412
EDN100/AA	2/18/2012	17531	SCHOOL CUSTODIAN II	N	BC02	01	P	A	0.50	16,614	0.50	16,614
EDN150/YC	2/18/2012	58528	BEHAVIORAL HLTH SPCLT IV	N	SR22	13	T	A	1.00	45,576	1.00	45,576
EDN150/YC	2/18/2012	58331	BEHAVIORAL HLTH SPCLT IV	N	SR22	13	P	A	1.00	47,412	1.00	47,412
EDN150/FA	2/21/2012	73040	SPEC ED TEACHER	Certificated	T03	05	P	A	1.00	48,008	1.00	47,287
EDN100/AA	2/22/2012	801543	SCHOOL CUSTODIAN II	N	BC02	01	T	A			0.50	16,614
EDN200/GH	2/23/2012	57913	DATA PROCSSG SYSTS ANAL IV	N	SR22	13	P	B	1.00	45,576	1.00	45,576
EDN150/SA	2/23/2012	66019	DISTRICT EDUC SPEC II	Certificated	E07	06	P	A	1.00	103,196	1.00	103,196
EDN100/AA	2/24/2012	68180	SECONDARY TEACHER	Certificated	T02	05	T	A	1.00	45,785	1.00	45,098
EDN100/AA	2/25/2012	23302	EDUC ASST III	Y	SR12	03	P	A	1.00	26,131	1.00	25,030
EDN100/AA	2/25/2012	64783	SECONDARY TEACHER	Certificated	T02	05	P	A	1.00	48,008	1.00	32,222
EDN150/FA	2/25/2012	64481	SPEC ED TEACHER	Certificated	T03	05	P	A	1.00	45,747	1.00	45,909
EDN100/AA	2/28/2012	31686	SCHOOL CUSTODIAN II	N	BC02	01	P	A	1.00	33,228	1.00	33,228
EDN400/MD	3/1/2012	59904	CAFETERIA HELPER	N	BC02	01	P	A			0.50	16,614
EDN100/AA	3/1/2012	29514	SCHOOL HEALTH AIDE	N	SR09	03	P	A	1.00	18,873	1.00	18,078
EDN100/AA	3/1/2012	30594	SCHOOL SECURITY ATTENDANT	N	SR07	03	P	A	1.00	23,229	1.00	22,250
EDN150/NB	3/1/2012	38737	CLERK TYPIST II	N	SR08	03	T	N			1.00	25,668
EDN100/AA	3/1/2012	39925	CLERK TYPIST II	N	SR08	03	P	A	1.00	30,036	1.00	30,036
EDN150/FA	3/1/2012	52730	EDUC ASST III	Y	SR12	03	P	A	1.00	31,769	1.00	30,430
EDN100/AA	3/1/2012	22580	SCHOOL CUSTODIAN II	N	BC02	01	P	A	1.00	33,228	1.00	33,228
EDN400/MD	3/1/2012	10500	SCHOOL COOK I	N	BC04	01	P	A			1.00	35,544
EDN400/MD	3/1/2012	9834	SCHOOL BAKER	N	BC06	01	P	A			1.00	38,436
EDN100/DB	3/1/2012	79662	SECONDARY TEACHER	Certificated	T02	05	T	N			1.00	43,785
EDN100/AA	3/1/2012	69301	ELEM TEACHER	Certificated	T03	05	P	A	1.00	46,609	1.00	45,909
EDN400/MD	3/1/2012	19250	SCHOOL FOOD SERVICES MGR III	N	F206	02	P	A	1.00	50,376	1.00	49,056
EDN100/AA	3/1/2012	62981	ELEM TEACHER	Certificated	T05	05	P	A	1.00	43,157	1.00	52,680
EDN100/AA	3/1/2012	66276	SECONDARY TEACHER	Certificated	T07	05	P	A	1.00	68,351	1.00	67,325
EDN150/FA	3/6/2012	800044	EDUC ASST II	Y	SR10	03	T	A	0.75	19,599	0.75	17,348
EDN100/AA	3/6/2012	801077	OFFICE ASSISTANT III	N	SR08	03	T	A			1.00	25,668
EDN150/SA	3/8/2012	30495	COMMUNICATION AIDE	Y	SR12	03	P	A	0.50	14,684	0.50	12,515
EDN100/AA	3/9/2012	39106	EDUC ASST III	Y	SR12	03	P	A	1.00	27,154	1.00	24,710
EDN100/AA	3/10/2012	39108	EDUC ASST III	Y	SR12	03	P	A	0.50	13,066	0.50	12,515
EDN150/SA	3/10/2012	56374	SPEECH PATHOLOGIST IV	Y	SR22	13	P	A	1.00	58,563	1.00	45,576
EDN150/YG	3/13/2012	801817	SOCIAL WORKER IV	N	SR22	13	P	A			1.00	47,412
EDN150/YC	3/14/2012	58419	BEHAVIORAL HLTH SPCLT IV	N	SR22	13	T	A	1.00	45,576	1.00	45,576
EDN100/AA	3/14/2012	69872	ELEM TEACHER	Certificated	T03	05	P	A	1.00	49,448	1.00	48,706
EDN150/YG	3/15/2012	800848	EDUC ASST III	Y	SR12	03	P	A	1.00	27,154	1.00	26,010
EDN100/AA	3/16/2012	59724	OFFICE ASSISTANT III	N	SR08	03	T	A			0.50	12,834
EDN400/MD	3/16/2012	802013	CAFETERIA HELPER	N	BC02	01	T	A			0.50	16,614
EDN150/FA	3/16/2012	56742	EDUC ASST III	Y	SR12	03	P	A	1.00	29,368	1.00	26,720
EDN150/YC	3/17/2012	59135	OFFICE ASSISTANT III	N	SR08	03	T	A	0.50	12,834	0.50	12,834
EDN200/GN	3/17/2012	58100	OFFICE ASSISTANT III	N	SR08	03	P	A	1.00	25,668	1.00	25,668
EDN100/AA	3/17/2012	33425	OFFICE ASSISTANT III	N	SR08	03	P	A	1.00	31,212	1.00	31,212
EDN100/AA	3/17/2012	802200	DP USER SUPPORT TECH I	N	SR13	03	T	A			1.00	31,212
EDN150/FA	3/17/2012	68896	SPEC ED TEACHER	Certificated	T02	05	P	A	1.00	60,779	1.00	32,222

Prog ID/Org	Separation Date	Position Number	Position Title	Exempt (Y/N)	SR Level	BU Code	T/P	MOF	Budgeted FTE	Budgeted Salary	Actual FTE	Actual Salary
EDN100/AA	3/17/2012	64019	SECONDARY TEACHER	Certificated	T03	05	P	A	1.00	46,609	1.00	45,909
EDN100/AA	3/21/2012	16719	SCHOOL CUSTODIAN III	N	WS02	01	P	A	1.00	35,544	1.00	35,544
EDN100/AA	3/21/2012	67006	SECONDARY TEACHER	Certificated	T03	05	P	A	1.00	45,785	1.00	45,909
EDN100/AA	3/21/2012	72301	SECONDARY TEACHER	Certificated	T03	05	P	A	1.00	60,729	1.00	45,909
EDN400/MD	3/22/2012	45866	CAFETERIA HELPER	N	BC02	01	T	N	0.50	16,614	0.50	16,614
EDN150/FA	3/22/2012	63219	GEN EDUC/ARTICLE VI TCHR	Certificated	E03	05	P	A	1.00	70,400	1.00	47,287
EDN100/AA	3/23/2012	44325	LIBRARY ASSISTANT II	N	SR05	03	P	A	0.50	12,834	0.50	11,844
EDN400/MD	3/23/2012	45999	CAFETERIA HELPER	N	BC02	01	P	A			0.50	16,614
EDN400/MD	3/24/2012	9503	CAFETERIA HELPER	N	BC02	01	P	A			1.00	33,228
EDN100/AA	3/27/2012	600804	SECONDARY TEACHER	Certificated	T03	05	T	A			1.00	45,909
EDN150/FA	3/28/2012	51220	EDUC ASST III	Y	SR12	03	P	A	0.50	13,066	0.50	12,515
EDN150/NB	3/28/2012	58151	EDUC ASST II	Y	SR10	03	T	N			1.00	23,130
EDN150/FA	3/28/2012	73357	GEN EDUC/ARTICLE VI TCHR	Certificated	T03	05	P	A	1.00	49,448	1.00	48,706
EDN150/FB	3/30/2012	29121	CLERK TYPIST II	N	SR08	03	P	A	1.00	28,836	1.00	28,836
EDN100/AA	3/31/2012	38447	OFFICE ASSISTANT III	N	SR08	03	P	A	0.50	14,418	0.50	14,418
EDN100/AA	3/31/2012	25822	SCHOOL CUSTODIAN II	N	BC02	01	P	A	0.50	16,614	0.50	16,614
EDN400/MD	3/31/2012	44462	CAFETERIA HELPER	N	BC02	01	T	N	0.50	16,614	0.50	16,614
EDN100/AA	3/31/2012	27264	OFFICE ASSISTANT III	N	SR08	03	P	A	0.50	17,532	0.50	17,532
EDN100/AA	3/31/2012	33122	SCHOOL SECURITY ATTENDANT	N	SR07	03	P	A	1.00	24,148	1.00	23,130
EDN150/FA	3/31/2012	801337	EDUC ASST III	Y	SR12	03	T	A	1.00	26,131	1.00	23,780
EDN150/FA	3/31/2012	44013	EDUC ASST III	Y	SR12	03	P	A	1.00	26,131	1.00	25,030
EDN150/NB	3/31/2012	40066	OFFICE ASSISTANT III	N	SR08	03	T	N	1.00	25,668	1.00	25,668
EDN100/AA	3/31/2012	44441	LIBRARY ASSISTANT III	N	SR07	03	P	A	1.00	27,756	1.00	27,756
EDN100/AA	3/31/2012	16200	SCHOOL CUSTODIAN II	N	BC02	01	P	A	1.00	33,228	1.00	33,228
EDN100/AA	3/31/2012	16379	SCHOOL CUSTODIAN II	N	BC02	01	P	A	1.00	33,228	1.00	33,228
EDN100/AA	3/31/2012	16243	SCHOOL CUSTODIAN III	N	WS02	01	P	A	1.00	35,544	1.00	35,544
EDN100/AA	3/31/2012	16634	SCHOOL CUSTODIAN III	N	WS02	01	P	A	1.00	35,544	1.00	35,544
EDN100/AA	3/31/2012	16822	SCHOOL CUSTODIAN III	N	WS02	01	P	A	1.00	35,544	1.00	35,544
EDN400/MD	3/31/2012	9423	SCHOOL COOK II	N	BC06	01	P	A			1.00	38,436
EDN150/YC	3/31/2012	58410	BEHAVIORAL HLTH SPCLT III	N	SR20	13	P	A	1.00	45,576	1.00	42,132
EDN150/SA	3/31/2012	56177	SPEECH PATHOLOGIST III	Y	SR20	13	P	A	1.00	57,999	1.00	42,132
EDN150/FA	3/31/2012	66868	SPEC ED TEACHER	Certificated	T02	05	P	A	1.00	43,157	1.00	42,509
EDN100/AA	3/31/2012	601567	ELEM TEACHER	Certificated	T02	05	T	A			1.00	42,509
EDN100/AA	3/31/2012	65806	COUNSELOR	Certificated	T03	05	P	A	1.00	73,558	1.00	45,909
EDN150/FA	3/31/2012	71275	SPEC ED TEACHER	Certificated	T03	05	T	A			1.00	45,909
EDN400/OC	3/31/2012	34314	ENGINEER V	N	SR26	13	P	A	1.00	70,178	1.00	55,500
EDN150/SA	3/31/2012	50765	HUMAN SVCS PROF IV	N	SR22	13	P	A	1.00	56,994	1.00	55,500
EDN150/YC	3/31/2012	58436	BEHAVIORAL HLTH SPCLT IV	N	SR22	13	P	A	1.00	64,920	1.00	57,708
EDN300/UA	3/31/2012	73097	TELECOMM NETWORK SPEC II	Certificated	E07	06	P	A			1.00	77,069
EDN150/FA	4/1/2012	37978	EDUC ASST III	Y	SR12	03	P	A	0.75	22,879	0.75	21,915
EDN100/AA	4/1/2012	16484	SCHOOL CUSTODIAN II	N	BC02	01	P	A	1.00	33,228	1.00	33,228
EDN100/AA	4/1/2012	72238	SECONDARY TEACHER	Certificated	T04	05	P	A	1.00	57,880	1.00	57,011
EDN150/FA	4/1/2012	64286	SPEC ED TEACHER	Certificated	T02	05	P	A	1.00	57,999	1.00	57,129
EDN100/AA	4/1/2012	62809	ELEM TEACHER	Certificated	T07	05	P	A	1.00	60,004	1.00	58,074
EDN150/NB	4/1/2012	79448	DIST OFF TCHR	Certificated	T05	05	T	N			1.00	59,292

Prog ID/Org	Separation Date	Position Number	Position Title	Exempt (Y/N)	SR Level	BU Code	T/P	MOF	Budgeted FTE	Budgeted Salary	Actual FTE	Actual Salary
EDN100/AA	4/1/2012	67956	ELEM TEACHER	Certificated	T07	05	T	A	1.00	60,729	1.00	59,818
EDN100/AA	4/1/2012	65836	LIBRARIAN	Certificated	T03	05	P	A	1.00	63,934	1.00	61,699
EDN100/AA	4/1/2012	62189	COUNSELOR	Certificated	T07	05	P	A	1.00	66,359	1.00	65,363
EDN100/AA	4/1/2012	60328	ELEM TEACHER	Certificated	T07	05	P	A	1.00	46,830	1.00	69,344
EDN100/AA	4/3/2012	43993	EDUC ASST II	Y	SR10	03	P	A	1.00	29,368	1.00	23,130
EDN300/KO	4/3/2012	59041	PERSONNEL MGMT SPECIALIST VI	N	SR26	13	P	A	1.00	73,044	1.00	73,044
EDN100/AA	4/4/2012	49125	SCHOOL CUSTODIAN II	N	BC02	01	P	A	0.50	16,614	0.50	16,614
EDN100/AA	4/6/2012	39093	CLERK TYPIST II	N	SR08	03	P	A	0.50	13,350	0.50	12,834
EDN100/CB	4/6/2012	29316	SCHOOL HEALTH AIDE	N	SR09	03	P	A	1.00	21,231	1.00	18,078
EDN150/FA	4/6/2012	800063	EDUC ASST III	Y	SR12	03	T	A	1.00	34,347	1.00	25,030
EDN400/OC	4/6/2012	16804	POWER MOWER OPERATOR SUPVR	N	F104	02	P	A	1.00	40,176	1.00	40,176
EDN150/YG	4/7/2012	801832	EDUC ASST III	Y	SR12	03	T	A			1.00	30,036
EDN150/FA	4/7/2012	69802	SPEC ED TEACHER	Certificated	T03	05	P	A	1.00	70,400	1.00	47,287
EDN100/BM	4/10/2012	801120	ATHLETIC HLTH CARE TRAINER	Y	SR22	13	P	A	1.00	45,576	1.00	45,576
EDN100/DB	4/10/2012	79467	DIST OFF TCHR	Certificated	T03	05	T	N			1.00	45,909
EDN100/AA	4/10/2012	60672	SECONDARY TEACHER	Certificated	T03	05	P	A	1.00	48,008	1.00	45,909
EDN100/AA	4/13/2012	32886	SCHOOL CUSTODIAN II	N	BC02	01	P	A	0.50	16,614	0.50	16,614
EDN300/KO	4/14/2012	59128	PERSONNEL CLERK V	N	SR13	03	P	A	1.00	37,968	1.00	16,211
EDN100/AA	4/14/2012	16473	SCHOOL CUSTODIAN II	N	BC02	01	P	A	0.50	16,614	0.50	16,614
EDN150/FA	4/14/2012	46939	EDUC ASST III	Y	SR12	03	P	A	0.75	19,599	0.75	18,773
EDN100/AA	4/14/2012	802110	EDUC ASST II	Y	SR10	03	T	A			1.00	23,130
EDN150/FA	4/14/2012	38342	EDUC ASST III	Y	SR12	03	P	A	1.00	35,705	1.00	26,010
EDN150/FA	4/14/2012	54828	EDUC ASST III	Y	SR12	03	P	A	1.00	28,209	1.00	27,020
EDN100/AA	4/14/2012	16284	SCHOOL CUSTODIAN III	N	WS02	01	P	A	1.00	35,544	1.00	35,544
EDN100/AA	4/14/2012	66752	SECONDARY TEACHER	Certificated	T03	05	P	A	1.00	46,609	1.00	48,706
EDN150/YG	4/14/2012	801198	BEHAVIORAL HLTH SPCLT IV	N	SR22	13	P	A	1.00	45,576	1.00	49,332
EDN100/AA	4/17/2012	40416	OFFICE ASSISTANT III	N	SR08	03	P	A	1.00	25,668	1.00	25,668
EDN100/AA	4/17/2012	56598	OFFICE ASSISTANT III	N	SR08	03	P	A	1.00	25,668	1.00	25,668
EDN100/AA	4/17/2012	27263	OFFICE ASSISTANT III	N	SR08	03	P	A	1.00	28,836	1.00	28,836
EDN150/FA	4/18/2012	55281	EDUC ASST III	Y	SR12	03	P	A	1.00	31,769	1.00	30,430
EDN100/AA	4/19/2012	59021	SCHOOL SECURITY ATTENDANT	N	SR07	03	P	A	1.00	21,444	1.00	20,540
EDN150/FA	4/20/2012	32033	EDUC ASST III	Y	SR12	03	P	A	1.00	30,506	1.00	29,220
EDN100/AA	4/20/2012	61674	COUNSELOR/ALIENATION	Certificated	T03	05	P	A	1.00	48,008	1.00	47,287
EDN150/FA	4/21/2012	57359	EDUC ASST II	Y	SR10	03	P	A	0.75	19,599	0.75	17,348
EDN100/AA	4/21/2012	600866	ELEM TEACHER	Certificated	T02	05	T	A			1.00	42,509
EDN150/FA	4/21/2012	62234	SPEC ED TEACHER	Certificated	T02	05	P	A	1.00	53,483	1.00	43,785
EDN100/BM	4/21/2012	52457	ATHLETIC HLTH CARE TRAINER	Y	SR22	13	P	A	1.00	53,352	1.00	53,352
EDN200/GP	4/21/2012	60068	EVALUATION SPEC II	Certificated	E07	06	P	A	1.00	87,340	1.00	87,340
EDN100/BM	4/25/2012	52463	ATHLETIC HLTH CARE TRAINER	Y	SR22	13	P	A	1.00	45,576	1.00	45,576
EDN150/YC	4/26/2012	58654	BEHAVIORAL HLTH SPCLT III	N	SR20	13	T	A	1.00	45,576	1.00	42,132
EDN100/AA	4/28/2012	29379	SCHOOL HEALTH AIDE	N	SR09	03	P	A	1.00	19,620	1.00	18,793
EDN100/AA	5/1/2012	52955	SCHOOL CUSTODIAN II	N	BC02	01	P	A	0.50	16,614	0.50	16,614
EDN150/FA	5/1/2012	58138	EDUC ASST II	Y	SR10	03	P	A	0.75	21,157	0.75	17,348
EDN100/AA	5/1/2012	59963	SCHOOL SECURITY ATTENDANT	N	SR07	03	T	A	1.00	21,444	1.00	20,540
EDN100/AA	5/1/2012	600385	ELEM TEACHER	Certificated	T04	05	T	A			0.50	27,676

Department of Education
Personnel Separations

Table 15

<u>Prog ID/Org</u>	<u>Separation Date</u>	<u>Position Number</u>	<u>Position Title</u>	<u>Exempt (Y/N)</u>	<u>SR Level</u>	<u>BU Code</u>	<u>T/P</u>	<u>MOF</u>	<u>Budgeted FTE</u>	<u>Budgeted Salary</u>	<u>Actual FTE</u>	<u>Actual Salary</u>
EDN150/FA	5/1/2012	58955	EDUC ASST III	Y	SR12	03	P	A	1.00	29,368	1.00	28,130
EDN100/AA	5/1/2012	51965	EDUC ASST III	Y	SR12	03	P	A	1.00	33,032	1.00	31,640
EDN100/AA	5/1/2012	16360	SCHOOL CUSTODIAN II	N	BC02	01	P	A	1.00	33,228	1.00	33,228
EDN100/AA	5/1/2012	23566	SCHOOL CUSTODIAN II	N	BC02	01	P	A	1.00	33,228	1.00	33,228
EDN400/MD	5/1/2012	9386	SCHOOL COOK II	N	BC06	01	P	A			1.00	38,436
EDN400/MD	5/1/2012	11147	SCHOOL BAKER	N	BC06	01	P	A			1.00	38,436
EDN100/AA	5/1/2012	72165	SECONDARY TEACHER	Certificated	T02	05	P	A	1.00	50,412	1.00	42,509
EDN100/AA	5/1/2012	66485	SECONDARY TEACHER	Certificated	T03	05	P	A	1.00	46,609	1.00	45,909
EDN100/AA	5/1/2012	71609	ELEM TEACHER	Certificated	T05	05	P	A	1.00	54,778	1.00	52,680
EDN100/AA	5/1/2012	66072	ELEM TEACHER	Certificated	T05	05	P	A	1.00	56,740	1.00	55,888
EDN100/AA	5/1/2012	67555	SECONDARY TEACHER	Certificated	T07	05	P	A	1.00	70,400	1.00	69,344
EDN400/MD	5/2/2012	9440	SCHOOL COOK II	N	BC06	01	P	A			1.00	38,436
EDN100/AA	5/5/2012	801067	OFFICE ASSISTANT III	N	SR08	03	T	A			0.50	12,834
EDN400/MD	5/5/2012	54444	SCHOOL BAKER	N	BC06	01	P	A	1.00	38,436	1.00	38,436
EDN100/AA	5/5/2012	73705	COUNSELOR	Certificated	T06	05	T	A	1.00	70,461	1.00	69,404
EDN100/AA	5/8/2012	600113	ELEM TEACHER	Certificated	T03	05	T	A			1.00	45,909
EDN150/FA	5/9/2012	37503	EDUC ASST III	Y	SR12	03	P	A	1.00	30,506	1.00	28,130
EDN150/FA	5/9/2012	75854	SPEC ED TEACHER	Certificated	T07	05	P	A	1.00	46,609	1.00	58,074
EDN100/AA	5/10/2012	16393	SCHOOL CUSTODIAN II	N	BC02	01	P	A	1.00	33,228	1.00	33,228
EDN100/AA	5/12/2012	802253	DP USER SUPPORT TECH II	N	SR15	03	T	A			1.00	17,528
EDN150/YC	5/12/2012	800438	SCHOOL PSYCHOLOGIST	Y	SR24	13	P	A	1.00	58,716	1.00	51,312
EDN100/AA	5/15/2012	16616	SCHOOL CUSTODIAN II	N	BC02	01	P	A	1.00	33,228	1.00	33,228
EDN100/AA	5/16/2012	46927	SCHOOL CUSTODIAN II	N	BC02	01	P	A	0.50	16,614	0.50	16,614
EDN150/YC	5/16/2012	800437	SCHOOL PSYCHOLOGIST	Y	SR24	13	P	A	1.00	67,428	1.00	26,644
EDN150/FA	5/16/2012	27682	EDUC ASST III	Y	SR12	03	P	A	1.00	28,209	1.00	27,020
EDN150/YG	5/16/2012	801669	BEHAVIORAL HLTH SPCLT IV	N	SR22	13	T	A			1.00	45,576
EDN100/AA	5/17/2012	58253	OFFICE ASSISTANT II	N	SR06	03	P	A	1.00	27,756	1.00	27,756
EDN100/AA	5/18/2012	58796	SCHOOL CUSTODIAN II	N	BC02	01	P	A	0.50	16,614	0.50	16,614
EDN200/GP	5/18/2012	14585	SECRETARY II	N	SR14	03	P	A	1.00	41,040	1.00	16,837
EDN150/NB	5/18/2012	800504	EDUC ASST III	Y	SR12	03	T	N			1.00	25,030
EDN150/FA	5/18/2012	75804	GEN EDUC/ARTICLE VI TCHR	Certificated	T03	05	P	A	1.00	49,844	1.00	48,706
EDN100/AA	5/19/2012	16315	SCHOOL CUSTODIAN II	N	BC02	01	P	A	1.00	33,228	1.00	33,228
EDN100/AA	5/19/2012	600077	SECONDARY TEACHER	Certificated	T02	05	T	A			1.00	42,509
EDN100/AA	5/19/2012	74908	ELEM TEACHER	Certificated	T02	05	T	A	1.00	44,452	1.00	43,785
EDN100/AA	5/19/2012	60823	SECONDARY TEACHER	Certificated	T03	05	P	A	1.00	55,493	1.00	48,706
EDN100/AA	5/24/2012	60675	SECONDARY TEACHER	Certificated	T02	05	P	A	1.00	43,157	1.00	42,509
EDN150/FA	5/25/2012	57423	EDUC ASST II	Y	SR10	03	T	A	0.75	19,599	0.75	17,348
EDN150/FA	5/25/2012	37289	EDUC ASST III	Y	SR12	03	P	A	1.00	28,209	1.00	25,030
EDN100/AA	5/25/2012	51244	SCHOOL CUSTODIAN II	N	BC02	01	P	A	1.00	33,228	1.00	33,228
EDN100/AA	5/25/2012	600533	SECONDARY TEACHER	Certificated	T02	05	T	A			1.00	42,509
EDN100/AA	5/25/2012	66725	SECONDARY TEACHER	Certificated	T03	05	P	A	1.00	49,448	1.00	48,706
EDN100/AA	5/25/2012	60635	ELEM TEACHER	Certificated	T05	05	P	A	1.00	52,970	1.00	51,146
EDN100/AA	5/25/2012	69522	LIBRARIAN	Certificated	T07	05	P	A	1.00	62,024	1.00	59,818
EDN150/FA	5/26/2012	801899	EDUC ASST III	Y	SR12	03	T	A			0.50	12,515
EDN150/SA	5/26/2012	30496	COMMUNICATION AIDE	Y	SR12	03	P	A	0.50	13,066	0.50	12,515

Prog ID/Org	Separation Date	Position Number	Position Title	Exempt (Y/N)	SR Level	BU Code	T/P	MOF	Budgeted FTE	Budgeted Salary	Actual FTE	Actual Salary
EDN400/MD	5/26/2012	34238	CAFETERIA HELPER	N	BC02	01	T	N	0.50	16,614	0.50	16,614
EDN150/NB	5/26/2012	801755	EDUC ASST II	Y	SR10	03	T	N			0.75	17,348
EDN150/FA	5/26/2012	801295	EDUC ASST III	Y	SR12	03	T	A	0.75	19,599	0.75	18,773
EDN100/CB	5/26/2012	29306	SCHOOL HEALTH AIDE	N	SR09	03	P	A	1.00	22,063	1.00	21,133
EDN150/FA	5/26/2012	56773	EDUC ASST III	Y	SR12	03	T	A	1.00	26,131	1.00	25,030
EDN150/YG	5/26/2012	800833	EDUC ASST III	Y	SR12	03	P	A	1.00	26,131	1.00	25,030
EDN150/YG	5/26/2012	800880	EDUC ASST III	Y	SR12	03	P	A	1.00	26,131	1.00	25,030
EDN150/YG	5/26/2012	801730	EDUC ASST III	Y	SR12	03	T	A			1.00	25,030
EDN150/SA	5/26/2012	56372	SPEECH PATHOLOGIST III	Y	SR20	13	P	A	1.00	58,563	1.00	42,132
EDN150/SA	5/26/2012	56285	SPEECH PATHOLOGIST IV	Y	SR22	13	P	A	1.00	59,212	1.00	47,412
EDN100/AA	5/26/2012	72638	ELEM TEACHER	Certificated	T07	05	P	A	1.00	63,959	1.00	58,074
EDN100/AA	5/26/2012	73575	SECONDARY TEACHER	Certificated	T06	05	P	A	1.00	74,688	1.00	73,567
EDN100/AA	5/29/2012	62712	COUNSELOR	Certificated	T03	05	P	A	1.00	57,291	0.50	22,955
EDN100/AA	5/29/2012	602472	ELEM TEACHER	Certificated	T03	05	T	A			0.50	22,955
EDN150/FA	5/29/2012	72755	SPEC ED TEACHER	Certificated	T02	05	P	A	1.00	52,471	1.00	42,509
EDN100/AA	5/29/2012	73422	ELEM TEACHER	Certificated	T02	05	P	A	1.00	43,157	1.00	42,509
EDN100/AA	5/29/2012	602491	ELEM TEACHER	Certificated	T02	05	T	A			1.00	42,509
EDN100/AA	5/29/2012	602338	ELEM TEACHER	Certificated	T02	05	T	A			1.00	42,509
EDN150/FA	5/29/2012	73248	SPEC ED TEACHER	Certificated	T02	05	P	A	1.00	49,448	1.00	42,509
EDN100/AA	5/29/2012	68307	SECONDARY TEACHER	Certificated	T02	05	P	A	1.00	52,460	1.00	42,509
EDN150/FA	5/29/2012	75567	GEN EDUC/ARTICLE VI TCHR	Certificated	T02	05	T	A	1.00	43,157	1.00	42,509
EDN100/AA	5/29/2012	62299	SECONDARY TEACHER	Certificated	T02	05	P	A	1.00	62,550	1.00	42,509
EDN150/FA	5/29/2012	67575	SPEC ED TEACHER	Certificated	T02	05	P	A	1.00	43,157	1.00	42,509
EDN100/AA	5/29/2012	601308	SECONDARY TEACHER	Certificated	T02	05	T	A			1.00	42,509
EDN150/FA	5/29/2012	74649	SPEC ED TEACHER	Certificated	T02	05	P	A	1.00	53,483	1.00	42,509
EDN150/FA	5/29/2012	75519	GEN EDUC/ARTICLE VI TCHR	Certificated	T02	05	P	A	1.00	44,452	1.00	43,785
EDN100/AA	5/29/2012	64275	ELEM TEACHER	Certificated	T02	05	T	A	1.00	44,452	1.00	43,785
EDN100/AA	5/29/2012	61710	SECONDARY TEACHER	Certificated	T02	05	P	A	1.00	52,968	1.00	43,785
EDN150/FA	5/29/2012	69690	SPEC ED TEACHER	Certificated	T02	05	P	A	1.00	44,452	1.00	43,785
EDN100/AA	5/29/2012	71558	ELEM TEACHER	Certificated	T03	05	P	A	1.00	66,359	1.00	45,909
EDN100/AA	5/29/2012	62323	SECONDARY TEACHER	Certificated	T03	05	P	A	1.00	79,170	1.00	45,909
EDN150/FA	5/29/2012	61862	SPEC ED TEACHER	Certificated	T03	05	P	A	1.00	62,603	1.00	45,909
EDN100/AA	5/29/2012	601322	SECONDARY TEACHER	Certificated	T03	05	T	A			1.00	45,909
EDN100/AA	5/29/2012	64570	SECONDARY TEACHER	Certificated	T03	05	P	A	1.00	48,008	1.00	45,909
EDN150/FA	5/29/2012	66490	GEN EDUC/ARTICLE VI TCHR	Certificated	T03	05	P	A	1.00	46,609	1.00	45,909
EDN100/AA	5/29/2012	64140	SECONDARY TEACHER	Certificated	T03	05	T	A	1.00	46,609	1.00	45,909
EDN150/FA	5/29/2012	71670	SPEC ED TEACHER	Certificated	T03	05	T	A	1.00	43,157	1.00	45,909
EDN100/AA	5/29/2012	69102	ELEM TEACHER	Certificated	T03	05	P	A	1.00	50,931	1.00	45,909
EDN150/FA	5/29/2012	602348	SPEC ED TEACHER	Certificated	T03	05	T	A			1.00	45,909
EDN150/FA	5/29/2012	600599	GEN EDUC/ARTICLE VI TCHR	Certificated	T03	05	T	A			1.00	45,909
EDN100/AA	5/29/2012	66497	SECONDARY TEACHER	Certificated	T03	05	P	A	1.00	62,639	1.00	47,287
EDN100/AA	5/29/2012	65373	ELEM TEACHER	Certificated	T03	05	T	A	1.00	43,157	1.00	47,287
EDN100/AA	5/29/2012	71991	ELEM TEACHER	Certificated	T03	05	P	A	1.00	48,008	1.00	47,287
EDN150/FA	5/29/2012	62392	SPEC ED TEACHER	Certificated	T03	05	P	A	1.00	45,785	1.00	47,287
EDN100/AA	5/29/2012	69158	ELEM TEACHER	Certificated	T03	05	P	A	1.00	50,743	1.00	47,287

<u>Prog ID/Org</u>	<u>Separation Date</u>	<u>Position Number</u>	<u>Position Title</u>	<u>Exempt (Y/N)</u>	<u>SR Level</u>	<u>BU Code</u>	<u>T/P</u>	<u>MOF</u>	<u>Budgeted FTE</u>	<u>Budgeted Salary</u>	<u>Actual FTE</u>	<u>Actual Salary</u>
EDN100/AA	5/29/2012	601172	ELEM TEACHER	Certificated	T03	05	T	A			1.00	47,287
EDN100/AA	5/29/2012	60625	ELEM TEACHER	Certificated	T03	05	P	A	1.00	48,008	1.00	47,287
EDN100/AA	5/29/2012	75601	ELEM TEACHER	Certificated	T03	05	T	A	1.00	49,448	1.00	48,706
EDN100/AA	5/29/2012	69521	SECONDARY TEACHER	Certificated	T04	05	P	A	1.00	49,448	1.00	50,654
EDN150/FA	5/29/2012	69766	GEN EDUC/ARTICLE VI TCHR	Certificated	T05	05	P	A	1.00	49,053	1.00	51,146
EDN150/FA	5/29/2012	60857	SPEC ED TEACHER	Certificated	T06	05	P	A	1.00	57,291	1.00	56,431
EDN100/AA	5/30/2012	72189	ELEM TEACHER	Certificated	T03	05	P	A	1.00	58,336	1.00	45,909
EDN150/FA	5/30/2012	71158	SPEC ED TEACHER	Certificated	T03	05	P	A	1.00	48,008	1.00	47,287
EDN100/AA	5/30/2012	601636	ELEM TEACHER	Certificated	T03	05	T	A			1.00	47,287
EDN100/AA	6/1/2012	802131	OFFICE ASSISTANT III	N	SR08	03	T	A			0.50	12,834
EDN400/MD	6/1/2012	34170	CAFETERIA HELPER	N	BC02	01	T	N	0.50	16,614	0.50	16,614
EDN400/MD	6/1/2012	25717	CAFETERIA HELPER	N	BC02	01	P	A			0.50	16,614
EDN100/AA	6/1/2012	26564	SCHOOL CUSTODIAN II	N	BC02	01	P	A	1.00	33,228	0.50	16,614
EDN100/CB	6/1/2012	29319	SCHOOL HEALTH AIDE	N	SR09	03	P	A	1.00	20,383	1.00	19,524
EDN100/AA	6/1/2012	29449	SCHOOL HEALTH AIDE	N	SR09	03	P	A	1.00	21,231	1.00	20,336
EDN100/AA	6/1/2012	30606	SCHOOL SECURITY ATTENDANT	N	SR07	03	P	A	1.00	30,506	1.00	20,540
EDN150/FA	6/1/2012	50368	EDUC ASST III	Y	SR12	03	P	A	0.75	22,879	0.75	21,915
EDN100/AA	6/1/2012	29415	SCHOOL HEALTH AIDE	N	SR09	03	P	A	1.00	24,786	1.00	23,741
EDN100/AA	6/1/2012	69511	SECONDARY TEACHER	Certificated	T04	05	P	A			0.50	24,590
EDN150/FA	6/1/2012	50876	EDUC ASST III	Y	SR12	03	P	A	0.75	25,761	0.75	24,675
EDN100/AA	6/1/2012	29513	SCHOOL HEALTH AIDE	N	SR09	03	P	A	1.00	25,812	1.00	24,724
EDN100/AA	6/1/2012	29363	SCHOOL HEALTH AIDE	N	SR09	03	P	A	1.00	25,812	1.00	24,724
EDN100/AA	6/1/2012	29418	SCHOOL HEALTH AIDE	N	SR09	03	P	A	1.00	29,010	1.00	27,787
EDN100/AA	6/1/2012	33119	SCHOOL SECURITY ATTENDANT	N	SR07	03	P	A	1.00	29,368	1.00	28,130
EDN100/AA	6/1/2012	14739	CLERK TYPIST II	N	SR08	03	P	A	1.00	28,836	1.00	28,836
EDN150/FA	6/1/2012	47122	EDUC ASST III	Y	SR12	03	P	A	1.00	30,506	1.00	29,220
EDN100/AA	6/1/2012	55019	EDUC ASST III	Y	SR12	03	P	A	1.00	30,506	1.00	29,220
EDN150/FA	6/1/2012	57028	EDUC ASST III	Y	SR12	03	T	A	1.00	30,506	1.00	29,220
EDN150/FA	6/1/2012	52677	EDUC ASST III	Y	SR12	03	P	A	1.00	30,506	1.00	29,220
EDN150/FA	6/1/2012	57043	EDUC ASST III	Y	SR12	03	P	A	1.00	31,769	1.00	30,430
EDN150/FA	6/1/2012	54432	EDUC ASST III	Y	SR12	03	P	A	1.00	31,769	1.00	30,430
EDN100/AA	6/1/2012	51981	EDUC ASST III	Y	SR12	03	P	A	1.00	31,769	1.00	30,430
EDN100/AA	6/1/2012	74051	COUNSELOR	Certificated	T07	05	P	A	1.00	55,087	0.50	30,806
EDN150/FA	6/1/2012	21623	EDUC ASST III	Y	SR12	03	P	A	1.00	33,032	1.00	31,640
EDN150/FA	6/1/2012	32134	EDUC ASST III	Y	SR12	03	P	A	1.00	34,347	1.00	32,900
EDN100/AA	6/1/2012	22913	SCHOOL CUSTODIAN II	N	BC02	01	P	A	1.00	33,228	1.00	33,228
EDN400/MD	6/1/2012	26885	CAFETERIA HELPER	N	BC02	01	P	A			1.00	33,228
EDN100/AA	6/1/2012	18851	OFFICE ASSISTANT III	N	SR08	03	P	A	1.00	33,756	1.00	33,756
EDN100/AA	6/1/2012	23345	OFFICE ASSISTANT III	N	SR08	03	P	A	1.00	33,756	1.00	33,756
EDN150/SA	6/1/2012	32222	COMMUNICATION AIDE	Y	SR12	03	P	A	1.00	35,705	1.00	34,200
EDN100/AA	6/1/2012	40819	OFFICE ASSISTANT III	N	SR08	03	P	A	1.00	35,064	1.00	35,064
EDN200/GJ	6/1/2012	57804	OFFICE ASSISTANT III	N	SR08	03	P	A	1.00	35,064	1.00	35,064
EDN100/AA	6/1/2012	41379	SCHOOL CUSTODIAN III	N	WS02	01	P	A	1.00	35,544	1.00	35,544
EDN150/FA	6/1/2012	27681	EDUC ASST III	Y	SR12	03	P	A	1.00	37,135	1.00	35,570
EDN400/MD	6/1/2012	9840	SCHOOL BAKER	N	BC06	01	P	A			1.00	38,436

<u>Prog ID/Org</u>	<u>Separation Date</u>	<u>Position Number</u>	<u>Position Title</u>	<u>Exempt (Y/N)</u>	<u>SR Level</u>	<u>BU Code</u>	<u>T/P</u>	<u>MOF</u>	<u>Budgeted FTE</u>	<u>Budgeted Salary</u>	<u>Actual FTE</u>	<u>Actual Salary</u>
EDN400/MD	6/1/2012	9404	SCHOOL BAKER	N	BC06	01	P	A			1.00	38,436
EDN400/MD	6/1/2012	11573	SCHOOL COOK II	N	BC06	01	P	A			1.00	38,436
EDN400/MD	6/1/2012	14631	SCHOOL BAKER	N	BC06	01	P	A			1.00	38,436
EDN400/MD	6/1/2012	55575	SCHOOL BAKER	N	BC06	01	P	A	1.00	38,436	1.00	38,436
EDN100/AA	6/1/2012	31742	SCHOOL ADM SERVICES ASST III	Certificated	SR16	04	P	A	1.00	44,412	1.00	44,412
EDN150/SA	6/1/2012	30438	SPEECH PATHOLOGIST IV	Y	SR22	13	P	A	1.00	57,999	1.00	45,576
EDN100/AA	6/1/2012	63948	ELEM TEACHER	Certificated	T03	05	P	A	1.00	68,351	1.00	45,909
EDN100/AA	6/1/2012	73193	SECONDARY TEACHER	Certificated	T03	05	T	A	1.00	32,713	1.00	45,909
EDN100/AA	6/1/2012	68076	ELEM TEACHER	Certificated	T03	05	P	A	1.00	46,609	1.00	45,909
EDN150/FA	6/1/2012	601042	SPEC ED TEACHER	Certificated	T03	05	P	A			1.00	45,909
EDN100/AA	6/1/2012	60322	SECONDARY TEACHER	Certificated	T02	05	P	A	1.00	32,713	1.00	46,451
EDN100/AA	6/1/2012	65207	SECONDARY TEACHER	Certificated	T02	05	P	A	1.00	47,159	1.00	46,451
EDN400/MD	6/1/2012	27303	SCHOOL FOOD SERVICES MGR III	N	F206	02	P	A	1.00	48,429	1.00	47,160
EDN100/AA	6/1/2012	69724	SECONDARY TEACHER	Certificated	T02	05	P	A	1.00	49,619	1.00	47,845
EDN150/FA	6/1/2012	67197	SPEC ED TEACHER	Certificated	T03	05	P	A	1.00	49,448	1.00	48,706
EDN100/AA	6/1/2012	67205	SECONDARY TEACHER	Certificated	T03	05	P	A	1.00	50,931	1.00	50,167
EDN150/FA	6/1/2012	68453	GEN EDUC/ARTICLE VI TCHR	Certificated	T03	05	P	A	1.00	50,931	1.00	50,167
EDN100/AA	6/1/2012	69912	ELEM TEACHER	Certificated	T03	05	P	A	1.00	50,931	1.00	50,167
EDN100/AA	6/1/2012	72683	ELEM TEACHER	Certificated	T02	05	P	A	1.00	51,532	1.00	50,759
EDN100/AA	6/1/2012	72550	SECONDARY TEACHER	Certificated	T02	05	P	A	1.00	51,532	1.00	50,759
EDN150/FA	6/1/2012	63741	GEN EDUC/ARTICLE VI TCHR	Certificated	T03	05	P	A	1.00	53,505	1.00	51,673
EDN100/AA	6/1/2012	66119	SECONDARY TEACHER	Certificated	T04	05	P	A	1.00	45,785	1.00	52,173
EDN150/FA	6/1/2012	72234	SPEC ED TEACHER	Certificated	T04	05	P	A	1.00	52,968	1.00	52,173
EDN150/FA	6/1/2012	73255	SPEC ED TEACHER	Certificated	T04	05	P	A	1.00	52,968	1.00	52,173
EDN100/AA	6/1/2012	63384	ELEM TEACHER	Certificated	T02	05	P	A	1.00	53,077	1.00	52,280
EDN100/AA	6/1/2012	67533	ELEM TEACHER	Certificated	T05	05	T	A	1.00	51,426	1.00	52,680
EDN100/AA	6/1/2012	600684	ELEM TEACHER	Certificated	T05	05	T	A			1.00	52,680
EDN100/AA	6/1/2012	65016	ELEM TEACHER	Certificated	T02	05	P	A	1.00	54,669	1.00	53,848
EDN100/AA	6/1/2012	74496	SECONDARY TEACHER	Certificated	T05	05	P	A	1.00	55,087	1.00	54,260
EDN100/AA	6/1/2012	65502	ELEM TEACHER	Certificated	T05	05	P	A	1.00	46,609	1.00	54,260
EDN100/BB	6/1/2012	68441	SECONDARY TEACHER	Certificated	T06	05	P	A	1.00	55,622	1.00	54,787
EDN100/AA	6/1/2012	71604	ELEM TEACHER	Certificated	T02	05	P	A	1.00	56,310	1.00	55,465
EDN100/AA	6/1/2012	62898	ELEM TEACHER	Certificated	T05	05	P	A	1.00	56,740	1.00	55,888
EDN100/AA	6/1/2012	69594	ELEM TEACHER	Certificated	T06	05	P	A	1.00	57,291	1.00	56,431
EDN100/AA	6/1/2012	63461	ELEM TEACHER	Certificated	T06	05	P	A	1.00	57,291	1.00	56,431
EDN150/FA	6/1/2012	71864	SPEC ED TEACHER	Certificated	T06	05	P	A	1.00	57,291	1.00	56,431
EDN100/AA	6/1/2012	67141	ELEM TEACHER	Certificated	T02	05	P	A	1.00	57,999	1.00	57,129
EDN100/AA	6/1/2012	65258	SECONDARY TEACHER	Certificated	T06	05	P	A	1.00	59,010	1.00	58,124
EDN100/AA	6/1/2012	61225	ELEM TEACHER	Certificated	T06	05	P	A	1.00	59,010	1.00	58,124
EDN150/FA	6/1/2012	73227	SPEC ED TEACHER	Certificated	T03	05	P	A	1.00	59,043	1.00	58,157
EDN100/AA	6/1/2012	72547	ELEM TEACHER	Certificated	T04	05	P	A	1.00	59,617	1.00	58,722
EDN100/AA	6/1/2012	66410	SECONDARY TEACHER	Certificated	T04	05	P	A	1.00	59,617	1.00	58,722
EDN150/FA	6/1/2012	73481	SPEC ED TEACHER	Certificated	T04	05	P	A	1.00	54,528	1.00	58,722
EDN150/FA	6/1/2012	73872	SPEC ED TEACHER	Certificated	T07	05	T	A	1.00	60,729	1.00	59,818
EDN150/FA	6/1/2012	75855	SPEC ED TEACHER	Certificated	T07	05	P	A	1.00	60,729	1.00	59,818

<u>Prog ID/Org</u>	<u>Separation Date</u>	<u>Position Number</u>	<u>Position Title</u>	<u>Exempt (Y/N)</u>	<u>SR Level</u>	<u>BU Code</u>	<u>T/P</u>	<u>MOF</u>	<u>Budgeted FTE</u>	<u>Budgeted Salary</u>	<u>Actual FTE</u>	<u>Actual Salary</u>
EDN150/FA	6/1/2012	64236	SPEC ED TEACHER	Certificated	T07	05	P	A	1.00	60,729	1.00	59,818
EDN100/AA	6/1/2012	64585	SECONDARY TEACHER	Certificated	T07	05	P	A	1.00	60,729	1.00	59,818
EDN100/AA	6/1/2012	60427	SECONDARY TEACHER	Certificated	T07	05	P	A	1.00	60,729	1.00	59,818
EDN100/AA	6/1/2012	73607	ELEM TEACHER	Certificated	T07	05	P	A	1.00	60,729	1.00	59,818
EDN100/AA	6/1/2012	68046	COUNSELOR	Certificated	T04	05	P	A	1.00	61,405	1.00	60,483
EDN150/FA	6/1/2012	71126	SPEC ED TEACHER	Certificated	T02	05	P	A	1.00	61,479	1.00	60,556
EDN150/FA	6/1/2012	71313	GEN EDUC/ARTICLE VI TCHR	Certificated	T05	05	T	A	1.00	62,002	1.00	61,071
EDN150/FA	6/1/2012	65483	GEN EDUC/ARTICLE VI TCHR	Certificated	T05	05	P	A	1.00	62,002	1.00	61,071
EDN100/AA	6/1/2012	71556	ELEM TEACHER	Certificated	T07	05	P	A	1.00	48,474	1.00	61,611
EDN200/GN	6/1/2012	75083	COMPLEX AREA TEACHER	Certificated	T07	05	P	A	1.00	56,195	1.00	61,611
EDN100/AA	6/1/2012	64040	ELEM TEACHER	Certificated	T07	05	P	A	1.00	62,550	1.00	61,611
EDN100/AA	6/1/2012	68434	COUNSELOR	Certificated	T06	05	P	A	1.00	62,603	1.00	61,663
EDN100/AA	6/1/2012	72534	SECONDARY TEACHER	Certificated	T03	05	P	A	1.00	66,389	1.00	61,699
EDN100/AA	6/1/2012	67258	ELEM TEACHER	Certificated	T04	05	P	A	1.00	64,293	1.00	62,299
EDN100/AA	6/1/2012	71602	ELEM TEACHER	Certificated	T05	05	P	A	1.00	63,861	1.00	62,903
EDN100/AA	6/1/2012	66361	ELEM TEACHER	Certificated	T07	05	P	A	1.00	64,427	1.00	63,460
EDN100/AA	6/1/2012	74677	SECONDARY TEACHER	Certificated	T07	05	P	A	1.00	69,427	1.00	63,460
EDN100/AA	6/1/2012	66252	ELEM TEACHER	Certificated	T06	05	P	A	1.00	64,482	1.00	63,514
EDN100/AA	6/1/2012	62183	SECONDARY TEACHER	Certificated	T06	05	P	A	1.00	65,777	1.00	63,514
EDN100/AA	6/1/2012	60407	ELEM TEACHER	Certificated	T06	05	P	A	1.00	65,527	1.00	63,514
EDN100/AA	6/1/2012	74137	12-MONTH REGISTRAR	Certificated	T04	05	P	A	1.00	78,174	1.00	64,167
EDN100/AA	6/1/2012	68651	ELEM TEACHER	Certificated	T05	05	P	A	1.00	67,073	1.00	64,791
EDN100/AA	6/1/2012	67850	ELEM TEACHER	Certificated	T07	05	P	A	1.00	67,404	1.00	65,363
EDN100/AA	6/1/2012	600112	ELEM TEACHER	Certificated	T03	05	T	A			1.00	65,401
EDN100/AA	6/1/2012	63774	SECONDARY TEACHER	Certificated	T03	05	T	A	1.00	67,442	1.00	65,401
EDN100/AA	6/1/2012	71121	ELEM TEACHER	Certificated	T05	05	P	A	1.00	67,750	1.00	66,733
EDN100/AA	6/1/2012	68386	COUNSELOR	Certificated	T05	05	P	A	1.00	67,750	1.00	66,733
EDN100/AA	6/1/2012	65340	ELEM TEACHER	Certificated	T07	05	P	A	1.00	68,351	1.00	67,325
EDN100/AA	6/1/2012	62468	SECONDARY TEACHER	Certificated	T07	05	P	A	1.00	68,351	1.00	67,325
EDN100/AA	6/1/2012	60127	ELEM TEACHER	Certificated	T07	05	P	A	1.00	74,646	1.00	67,325
EDN100/AA	6/1/2012	63871	ELEM TEACHER	Certificated	T07	05	P	A	1.00	68,351	1.00	67,325
EDN100/AA	6/1/2012	68534	SECONDARY TEACHER	Certificated	T07	05	P	A	1.00	69,396	1.00	67,325
EDN150/FA	6/1/2012	67163	GEN EDUC/ARTICLE VI TCHR	Certificated	T07	05	P	A	1.00	68,351	1.00	67,325
EDN100/AA	6/1/2012	67603	ELEM TEACHER	Certificated	T07	05	T	A	1.00	48,008	1.00	67,325
EDN100/AA	6/1/2012	74242	SECONDARY TEACHER	Certificated	T07	05	P	A	1.00	68,351	1.00	67,325
EDN100/AA	6/1/2012	64637	LIBRARIAN	Certificated	T07	05	P	A	1.00	69,646	1.00	67,325
EDN100/AA	6/1/2012	67183	ELEM TEACHER	Certificated	T07	05	P	A	1.00	69,396	1.00	67,325
EDN150/FA	6/1/2012	71351	SPEC ED TEACHER	Certificated	T07	05	P	A	1.00	68,351	1.00	67,325
EDN150/FA	6/1/2012	600099	SPEC ED TEACHER	Certificated	T06	05	T	A			1.00	67,381
EDN150/SA	6/1/2012	30442	SPEECH PATHOLOGIST IV	Y	SR22	13	P	A	1.00	69,305	1.00	67,488
EDN150/SA	6/1/2012	43766	SPEECH PATHOLOGIST IV	Y	SR22	13	P	A	1.00	69,305	1.00	67,488
EDN100/AA	6/1/2012	71345	SECONDARY TEACHER	Certificated	T04	05	P	A	1.00	70,099	1.00	68,018
EDN150/FA	6/1/2012	67184	SPEC ED TEACHER	Certificated	T04	05	P	A	1.00	69,054	1.00	68,018
EDN100/AA	6/1/2012	65592	SECONDARY TEACHER	Certificated	T04	05	P	A	1.00	69,054	1.00	68,018
EDN100/AA	6/1/2012	72680	ELEM TEACHER	Certificated	T04	05	P	A	1.00	69,054	1.00	68,018

<u>Prog ID/Org</u>	<u>Separation Date</u>	<u>Position Number</u>	<u>Position Title</u>	<u>Exempt (Y/N)</u>	<u>SR Level</u>	<u>BU Code</u>	<u>T/P</u>	<u>MOF</u>	<u>Budgeted FTE</u>	<u>Budgeted Salary</u>	<u>Actual FTE</u>	<u>Actual Salary</u>
EDN100/AA	6/1/2012	61134	SECONDARY TEACHER	Certificated	T04	05	P	A	1.00	69,054	1.00	68,018
EDN100/AA	6/1/2012	69939	ELEM TEACHER	Certificated	T07	05	P	A	1.00	70,400	1.00	69,344
EDN100/AA	6/1/2012	69624	ELEM TEACHER	Certificated	T07	05	P	A	1.00	70,400	1.00	69,344
EDN100/AA	6/1/2012	68653	SECONDARY TEACHER	Certificated	T07	05	P	A	1.00	71,445	1.00	69,344
EDN100/AA	6/1/2012	61535	LIBRARIAN	Certificated	T07	05	P	A	1.00	71,695	1.00	69,344
EDN100/AA	6/1/2012	61590	ELEM TEACHER	Certificated	T07	05	P	A	1.00	70,400	1.00	69,344
EDN100/AA	6/1/2012	64245	ELEM TEACHER	Certificated	T07	05	P	A	1.00	45,785	1.00	69,344
EDN100/AA	6/1/2012	66500	ELEM TEACHER	Certificated	T05	05	P	A	1.00	71,815	1.00	70,737
EDN100/AA	6/1/2012	65506	ELEM TEACHER	Certificated	T07	05	P	A	1.00	72,513	1.00	71,425
EDN100/AA	6/1/2012	66042	LIBRARIAN	Certificated	T07	05	P	A	1.00	73,808	1.00	71,425
EDN100/AA	6/1/2012	72001	SECONDARY TEACHER	Certificated	T07	05	P	A	1.00	72,513	1.00	71,425
EDN150/FA	6/1/2012	75875	SPEC ED TEACHER	Certificated	T07	05	P	A	1.00	72,513	1.00	71,425
EDN100/AA	6/1/2012	63953	SECONDARY TEACHER	Certificated	T07	05	P	A	1.00	72,513	1.00	71,425
EDN100/AA	6/1/2012	61354	ELEM TEACHER	Certificated	T07	05	P	A	1.00	72,513	1.00	71,425
EDN100/AA	6/1/2012	63568	ELEM TEACHER	Certificated	T07	05	P	A	1.00	72,513	1.00	71,425
EDN100/AA	6/1/2012	68971	ELEM TEACHER	Certificated	T07	05	P	A	1.00	72,513	1.00	71,425
EDN100/AA	6/1/2012	62140	ELEM TEACHER	Certificated	T07	05	P	A	1.00	72,513	1.00	71,425
EDN100/AA	6/1/2012	73682	SECONDARY TEACHER	Certificated	T07	05	P	A	1.00	72,513	1.00	71,425
EDN100/AA	6/1/2012	66634	COUNSELOR	Certificated	T07	05	P	A	1.00	72,513	1.00	71,425
EDN100/AA	6/1/2012	69886	ELEM TEACHER	Certificated	T06	05	P	A	1.00	75,983	1.00	73,567
EDN100/AA	6/1/2012	65053	LIBRARIAN	Certificated	T07	05	P	A	1.00	75,983	1.00	73,567
EDN100/AA	6/1/2012	65503	ELEM TEACHER	Certificated	T07	05	P	A	1.00	75,983	1.00	73,567
EDN100/AA	6/1/2012	65463	SECONDARY TEACHER	Certificated	T07	05	P	A	1.00	74,688	1.00	73,567
EDN100/AA	6/1/2012	75318	COUNSELOR/HIGH RISK	Certificated	T07	05	T	A			1.00	73,567
EDN100/AA	6/1/2012	62371	LIBRARIAN	Certificated	T07	05	P	A	1.00	75,983	1.00	73,567
EDN150/FA	6/1/2012	63165	SPEC ED TEACHER	Certificated	T07	05	P	A	1.00	74,688	1.00	73,567
EDN100/AA	6/1/2012	73474	ELEM TEACHER	Certificated	T07	05	P	A	1.00	74,688	1.00	73,567
EDN100/AA	6/1/2012	69759	SECONDARY TEACHER	Certificated	T07	05	P	A	1.00	74,688	1.00	73,567
EDN100/AA	6/1/2012	61424	ELEM TEACHER	Certificated	T07	05	P	A	1.00	74,688	1.00	73,567
EDN150/FA	6/1/2012	64191	SPEC ED TEACHER	Certificated	T06	05	P	A	1.00	74,688	1.00	73,567
EDN100/AA	6/1/2012	69120	ELEM TEACHER	Certificated	T07	05	P	A	1.00	46,609	1.00	73,567
EDN100/AA	6/1/2012	69198	ELEM TEACHER	Certificated	T07	05	P	A	1.00	74,688	1.00	73,567
EDN150/FA	6/1/2012	63102	SPEC ED TEACHER	Certificated	T07	05	P	A	1.00	74,688	1.00	73,567
EDN100/AA	6/1/2012	69401	ELEM TEACHER	Certificated	T06	05	P	A	1.00	74,688	1.00	73,567
EDN100/AA	6/1/2012	62974	ELEM TEACHER	Certificated	T07	05	P	A	1.00	80,215	1.00	77,982
EDN100/AA	6/1/2012	63854	SECONDARY TEACHER	Certificated	T07	05	P	A	1.00	80,215	1.00	77,982
EDN100/AA	6/1/2012	65886	SECONDARY TEACHER	Certificated	T07	05	P	A	1.00	79,170	1.00	77,982
EDN100/DB	6/1/2012	75096	DIST OFF TCHR	Certificated	T07	05	T	T			1.00	77,982
EDN150/FA	6/1/2012	66203	SPEC ED TEACHER	Certificated	T07	05	P	A	1.00	79,170	1.00	77,982
EDN100/AA	6/1/2012	62334	SECONDARY TEACHER	Certificated	T07	05	P	A	1.00	79,170	1.00	77,982
EDN100/AA	6/1/2012	66266	SECONDARY TEACHER	Certificated	T07	05	P	A	1.00	79,170	1.00	77,982
EDN100/AA	6/1/2012	60872	ELEM TEACHER	Certificated	T07	05	P	A	1.00	79,170	1.00	77,982
EDN100/AA	6/1/2012	73080	SECONDARY TEACHER	Certificated	T07	05	P	A	1.00	79,170	1.00	77,982
EDN100/AA	6/1/2012	71749	ELEM TEACHER	Certificated	T07	05	P	A	1.00	80,215	1.00	77,982
EDN150/FA	6/1/2012	66695	SPEC ED TEACHER	Certificated	T07	05	P	A	1.00	79,170	1.00	77,982

Department of Education
Personnel Separations

Table 15

<u>Prog ID/Org</u>	<u>Separation Date</u>	<u>Position Number</u>	<u>Position Title</u>	<u>Exempt (Y/N)</u>	<u>SR Level</u>	<u>BU Code</u>	<u>T/P</u>	<u>MOF</u>	<u>Budgeted FTE</u>	<u>Budgeted Salary</u>	<u>Actual FTE</u>	<u>Actual Salary</u>
EDN100/AA	6/1/2012	68650	SECONDARY TEACHER	Certificated	T07	05	P	A	1.00	80,465	1.00	77,982
EDN100/AA	6/1/2012	62913	SECONDARY TEACHER	Certificated	T07	05	P	A	1.00	79,170	1.00	77,982
EDN100/AA	6/1/2012	61785	ELEM TEACHER	Certificated	T07	05	P	A	1.00	80,215	1.00	77,982
EDN150/FA	6/1/2012	68359	SPEC ED TEACHER	Certificated	T07	05	P	A	1.00	79,170	1.00	77,982
EDN150/FA	6/1/2012	67534	GEN EDUC/ARTICLE VI TCHR	Certificated	T07	05	P	A	1.00	79,170	1.00	77,982
EDN100/AA	6/1/2012	74249	SECONDARY TEACHER	Certificated	T07	05	P	A	1.00	79,170	1.00	77,982
EDN100/BJ	6/1/2012	73022	SECONDARY TEACHER	Certificated	T07	05	P	A	1.00	79,170	1.00	77,982
EDN100/AA	6/1/2012	60409	SECONDARY TEACHER	Certificated	T07	05	P	A	1.00	53,483	1.00	77,982
EDN100/AA	6/1/2012	61658	SECONDARY TEACHER	Certificated	T07	05	P	A	1.00	79,170	1.00	77,982
EDN100/BB	6/1/2012	67765	SECONDARY TEACHER	Certificated	T07	05	P	A	1.00	79,170	1.00	77,982
EDN100/AA	6/1/2012	600103	VICE PRINCIPAL I	Certificated	E03	06	T	A			1.00	79,404
EDN100/AA	6/1/2012	67794	VICE PRINCIPAL I	Certificated	E03	06	P	A	1.00	86,837	1.00	80,514
EDN100/BS	6/1/2012	73395	ROTC INSTRUCTOR	Certificated	ROTC	05	T	A	1.00	72,396	1.00	83,793
EDN100/DB	6/1/2012	79191	PERSONNEL SPECIALIST III	Certificated	E08	06	T	N			1.00	103,196
EDN100/AA	6/1/2012	65498	12-MO ELEM PRIN III	Certificated	E07	06	P	A	1.00	108,527	1.00	108,527
EDN400/MD	6/2/2012	59850	CAFETERIA HELPER	N	BC02	01	P	A			0.50	16,614
EDN100/AA	6/2/2012	19059	ACCOUNT CLERK II	N	SR08	03	P	A	1.00	27,756	1.00	27,756
EDN150/FA	6/2/2012	602420	SPEC ED TEACHER	Certificated	T02	05	T	A			1.00	32,222
EDN150/FA	6/7/2012	71295	SPEC ED TEACHER	Certificated	T03	05	P	A	1.00	49,448	1.00	45,909
EDN200/GN	6/9/2012	58052	OFFICE ASSISTANT III	N	SR08	03	P	A	1.00	31,212	1.00	31,212
EDN100/AA	6/9/2012	69748	ELEM TEACHER	Certificated	T02	05	P	A	1.00	63,898	1.00	42,509
EDN100/BS	6/15/2012	72056	ROTC INSTRUCTOR	Certificated	ROTC	05	T	A	1.00	76,968	1.00	81,314
EDN200/GN	6/16/2012	801957	OFFICE ASSISTANT III	N	SR08	03	T	A			0.50	12,834
EDN100/BM	6/16/2012	52450	ATHLETIC HLTH CARE TRAINER	Y	SR22	13	P	A	1.00	45,576	1.00	45,576
EDN100/AA	6/16/2012	68965	ELEM TEACHER	Certificated	T03	05	P	A	1.00	46,609	1.00	45,909
EDN100/AA	6/16/2012	62989	12-MO ELEM PRIN II	Certificated	E06	06	P	A	1.00	126,460	1.00	126,460
EDN150/FA	6/19/2012	64365	GEN EDUC/ARTICLE VI TCHR	Certificated	T03	05	P	A	1.00	50,493	1.00	48,706
EDN100/AA	6/20/2012	40512	OFFICE ASSISTANT II	N	SR06	03	P	A	1.00	23,688	1.00	23,688
EDN150/YG	6/20/2012	801522	EDUC ASST III	Y	SR12	03	T	A			1.00	25,030
EDN150/SA	6/20/2012	56309	OCC THERAPIST IV	N	SR22	13	P	A	1.00	56,388	1.00	45,576
EDN100/AA	6/20/2012	71934	12-MO HS PRIN V	Certificated	E08	06	P	A	1.00	114,733	1.00	114,733
EDN150/FA	6/21/2012	74848	GEN EDUC/ARTICLE VI TCHR	Certificated	T02	05	P	A	1.00	43,157	1.00	42,509
EDN100/AA	6/22/2012	801344	LIBRARY ASSISTANT III	N	SR07	03	T	A	1.00	24,648	1.00	24,648
EDN100/AA	6/22/2012	61718	SECONDARY TEACHER	Certificated	T04	05	P	A	1.00	49,448	1.00	50,654
EDN150/FA	6/23/2012	56740	EDUC ASST II	Y	SR10	03	P	A	0.75	19,599	0.75	17,348
EDN100/AA	6/27/2012	72625	ELEM TEACHER	Certificated	T02	05	P	A	1.00	49,448	1.00	42,509
EDN100/AA	6/28/2012	61287	SECONDARY TEACHER	Certificated	T02	05	P	A	1.00	63,959	1.00	42,509
EDN100/AA	6/29/2012	16276	SCHOOL CUSTODIAN III	N	WS02	01	P	A	1.00	35,544	1.00	35,544
EDN100/AA	6/30/2012	54479	EDUC ASST II	Y	SR10	03	P	A	0.50	13,066	0.50	11,565
EDN150/FA	6/30/2012	55744	EDUC ASST III	Y	SR12	03	T	A	0.50	13,066	0.50	12,515
EDN150/FA	6/30/2012	55549	EDUC ASST III	Y	SR12	03	P	A	0.50	13,066	0.50	12,515
EDN150/FA	6/30/2012	53167	EDUC ASST III	Y	SR12	03	P	A	0.50	14,104	0.50	13,510
EDN150/FA	6/30/2012	51566	EDUC ASST III	Y	SR12	03	P	A	0.50	14,104	0.50	13,510
EDN100/AA	6/30/2012	55866	EDUC ASST III	Y	SR12	03	T	A	0.50	14,104	0.50	13,510
EDN100/AA	6/30/2012	56072	OFFICE ASSISTANT III	N	SR08	03	T	A	0.50	14,418	0.50	14,418

Department of Education
Personnel Separations

Table 15

<u>Prog ID/Org</u>	<u>Separation Date</u>	<u>Position Number</u>	<u>Position Title</u>	<u>Exempt (Y/N)</u>	<u>SR Level</u>	<u>BU Code</u>	<u>T/P</u>	<u>MOF</u>	<u>Budgeted FTE</u>	<u>Budgeted Salary</u>	<u>Actual FTE</u>	<u>Actual Salary</u>
EDN150/FA	6/30/2012	57410	EDUC ASST II	Y	SR10	03	P	A	0.62	16,332	0.63	14,456
EDN100/AA	6/30/2012	41721	OFFICE ASSISTANT III	N	SR08	03	P	A	0.50	12,834	0.50	15,018
EDN100/AA	6/30/2012	56073	OFFICE ASSISTANT III	N	SR08	03	T	A			0.50	15,018
EDN150/FA	6/30/2012	52522	EDUC ASST III	Y	SR12	03	P	A	0.50	15,885	0.50	15,215
EDN100/AA	6/30/2012	59744	SCHOOL SECURITY ATTENDANT	N	SR07	03	T	A	0.75	16,748	0.75	16,043
EDN200/GN	6/30/2012	48834	BILINGUAL/BICULTURAL S/H ASST	Y	SR11	03	T	A	0.50	16,212	0.50	16,212
EDN100/AA	6/30/2012	47009	SCHOOL CUSTODIAN II	N	BC02	01	P	A	0.50	16,614	0.50	16,614
EDN400/MD	6/30/2012	59511	CAFETERIA HELPER	N	BC02	01	T	N			0.50	16,614
EDN100/AA	6/30/2012	801065	SCHOOL CUSTODIAN II	N	BC02	01	T	A	0.50	16,614	0.50	16,614
EDN150/FA	6/30/2012	55383	EDUC ASST II	Y	SR10	03	P	A	0.75	19,599	0.75	17,348
EDN150/NB	6/30/2012	801751	EDUC ASST II	Y	SR10	03	T	N			0.75	17,348
EDN150/FA	6/30/2012	54832	EDUC ASST II	Y	SR10	03	T	A	0.75	19,599	0.75	17,348
EDN150/FA	6/30/2012	57669	EDUC ASST II	Y	SR10	03	T	A	1.00	30,506	0.75	17,348
EDN150/FA	6/30/2012	56119	EDUC ASST II	Y	SR10	03	P	A	0.75	19,599	0.75	17,348
EDN150/FA	6/30/2012	55446	EDUC ASST II	Y	SR10	03	P	A	0.75	19,599	0.75	17,348
EDN150/FA	6/30/2012	56125	EDUC ASST I	Y	SR08	03	P	A	0.75	21,157	0.75	17,348
EDN100/AA	6/30/2012	29373	SCHOOL HEALTH AIDE	N	SR09	03	P	A	1.00	21,231	1.00	18,078
EDN100/AA	6/30/2012	802226	EDUC ASST III	Y	SR12	03	T	A			0.75	18,773
EDN150/FA	6/30/2012	55305	EDUC ASST III	Y	SR12	03	P	A	0.75	19,599	0.75	18,773
EDN150/FA	6/30/2012	28474	EDUC ASST III	Y	SR12	03	P	A	0.75	19,599	0.75	18,773
EDN100/AA	6/30/2012	801386	EDUC ASST III	Y	SR12	03	T	A			0.75	18,773
EDN150/FA	6/30/2012	57565	EDUC ASST III	Y	SR12	03	T	A	0.75	20,366	0.75	18,773
EDN150/FA	6/30/2012	57558	EDUC ASST III	Y	SR12	03	T	A	0.75	19,599	0.75	18,773
EDN150/FA	6/30/2012	57215	EDUC ASST III	Y	SR12	03	T	A	0.75	19,599	0.75	18,773
EDN150/FA	6/30/2012	58877	EDUC ASST III	Y	SR12	03	T	A	0.75	19,599	0.75	18,773
EDN150/FA	6/30/2012	57421	EDUC ASST III	Y	SR12	03	T	A	0.75	20,366	0.75	19,508
EDN150/FA	6/30/2012	56730	EDUC ASST III	Y	SR12	03	T	A	0.75	20,366	0.75	19,508
EDN400/YA	6/30/2012	59163	BUS DRIVER	N	BC07	01	P	A	0.50	19,986	0.50	19,986
EDN400/YA	6/30/2012	59164	BUS DRIVER	N	BC07	01	P	A	0.50	19,986	0.50	19,986
EDN150/FA	6/30/2012	800153	EDUC ASST II	Y	SR10	03	T	A	0.88	23,760	0.88	20,239
EDN150/FA	6/30/2012	57508	EDUC ASST III	Y	SR12	03	T	A	0.75	19,599	0.75	20,265
EDN150/FA	6/30/2012	57625	EDUC ASST III	Y	SR12	03	T	A	0.75	21,157	0.75	20,265
EDN150/FA	6/30/2012	57634	EDUC ASST III	Y	SR12	03	T	A	0.75	21,157	0.75	20,265
EDN150/FA	6/30/2012	57262	EDUC ASST III	Y	SR12	03	T	A	0.75	22,026	0.75	21,097
EDN100/AA	6/30/2012	29317	SCHOOL HEALTH AIDE	N	SR09	03	P	A	1.00	22,063	1.00	21,133
EDN150/FA	6/30/2012	53127	EDUC ASST III	Y	SR12	03	T	A	0.87	22,865	0.88	21,901
EDN150/FA	6/30/2012	57399	EDUC ASST III	Y	SR12	03	T	A	0.75	22,879	0.75	21,915
EDN150/FA	6/30/2012	57624	EDUC ASST III	Y	SR12	03	T	A	0.75	22,879	0.75	21,915
EDN150/FA	6/30/2012	57628	EDUC ASST III	Y	SR12	03	T	A	0.75	22,879	0.75	21,915
EDN150/FA	6/30/2012	57629	EDUC ASST III	Y	SR12	03	T	A	0.75	22,879	0.75	21,915
EDN150/FA	6/30/2012	57416	EDUC ASST III	Y	SR12	03	P	A	0.75	22,879	0.75	21,915
EDN150/FA	6/30/2012	55132	EDUC ASST III	Y	SR12	03	T	A	0.75	22,879	0.75	21,915
EDN200/GH	6/30/2012	801609	OFFICE ASSISTANT I	N	SR04	03	T	B			1.00	21,948
EDN100/AA	6/30/2012	29388	SCHOOL HEALTH AIDE	N	SR09	03	P	A	1.00	22,919	1.00	21,953
EDN100/AA	6/30/2012	33049	SCHOOL SECURITY ATTENDANT	N	SR07	03	P	A	1.00	23,229	1.00	22,250

Department of Education
Personnel Separations

Table 15

<u>Prog ID/Org</u>	<u>Separation Date</u>	<u>Position Number</u>	<u>Position Title</u>	<u>Exempt (Y/N)</u>	<u>SR Level</u>	<u>BU Code</u>	<u>T/P</u>	<u>MOF</u>	<u>Budgeted FTE</u>	<u>Budgeted Salary</u>	<u>Actual FTE</u>	<u>Actual Salary</u>
EDN150/FA	6/30/2012	57154	EDUC ASST II	Y	SR10	03	T	A	1.00	26,131	1.00	23,130
EDN150/YG	6/30/2012	802284	EDUC ASST II	Y	SR10	03	T	A			1.00	23,130
EDN150/NB	6/30/2012	56843	EDUC ASST II	Y	SR10	03	T	N			1.00	23,130
EDN100/AA	6/30/2012	802323	EDUC ASST II	Y	SR10	03	T	A			1.00	23,130
EDN100/AA	6/30/2012	801551	EDUC ASST II	Y	SR10	03	T	A			1.00	23,130
EDN150/FA	6/30/2012	801468	EDUC ASST II	Y	SR10	03	T	A	1.00	26,131	1.00	23,130
EDN150/FA	6/30/2012	53012	EDUC ASST III	Y	SR12	03	P	A	0.88	24,683	0.88	23,642
EDN150/FA	6/30/2012	52938	EDUC ASST III	Y	SR12	03	P	A	0.88	26,693	0.88	23,642
EDN100/AA	6/30/2012	802175	OFFICE ASSISTANT II	N	SR06	03	T	A			1.00	23,688
EDN150/FA	6/30/2012	56960	EDUC ASST II	Y	SR10	03	T	A	1.00	27,154	1.00	24,030
EDN100/AA	6/30/2012	16708	SCHOOL CUSTODIAN II	N	BC02	01	P	A	0.75	24,921	0.75	24,921
EDN150/FA	6/30/2012	800197	EDUC ASST III	Y	SR12	03	P	A	1.00	26,131	1.00	25,030
EDN150/YG	6/30/2012	801526	EDUC ASST III	Y	SR12	03	T	A			1.00	25,030
EDN150/YG	6/30/2012	801732	EDUC ASST III	Y	SR12	03	T	A			1.00	25,030
EDN150/FA	6/30/2012	800397	EDUC ASST III	Y	SR12	03	T	A	1.00	26,131	1.00	25,030
EDN100/AA	6/30/2012	801360	EDUC ASST III	Y	SR12	03	T	A	0.75	19,599	1.00	25,030
EDN150/FA	6/30/2012	800167	EDUC ASST III	Y	SR12	03	T	A	1.00	26,131	1.00	25,030
EDN150/FA	6/30/2012	56903	EDUC ASST III	Y	SR12	03	T	A	0.75	19,599	1.00	25,030
EDN150/FA	6/30/2012	800583	EDUC ASST III	Y	SR12	03	T	A	1.00	26,131	1.00	25,030
EDN150/FA	6/30/2012	56849	EDUC ASST III	Y	SR12	03	T	A	1.00	27,154	1.00	25,030
EDN150/FA	6/30/2012	801258	EDUC ASST III	Y	SR12	03	T	A	1.00	26,131	1.00	25,030
EDN150/FA	6/30/2012	802352	EDUC ASST III	Y	SR12	03	T	A			1.00	25,030
EDN150/FA	6/30/2012	801287	EDUC ASST III	Y	SR12	03	T	A	1.00	26,131	1.00	25,030
EDN150/FA	6/30/2012	801283	EDUC ASST III	Y	SR12	03	T	A	1.00	26,131	1.00	25,030
EDN150/FA	6/30/2012	800771	EDUC ASST III	Y	SR12	03	T	A	1.00	26,131	1.00	25,030
EDN150/FA	6/30/2012	58811	EDUC ASST III	Y	SR12	03	T	A	1.00	26,131	1.00	25,030
EDN150/FA	6/30/2012	56927	EDUC ASST III	Y	SR12	03	T	A	1.00	26,131	1.00	25,030
EDN150/FA	6/30/2012	802343	EDUC ASST III	Y	SR12	03	T	A			1.00	25,030
EDN150/NB	6/30/2012	801554	EDUC ASST III	Y	SR12	03	T	N			1.00	25,030
EDN150/NB	6/30/2012	800627	EDUC ASST III	Y	SR12	03	T	N			1.00	25,030
EDN150/FA	6/30/2012	57417	EDUC ASST III	Y	SR12	03	T	A	0.87	26,693	0.88	25,568
EDN100/AA	6/30/2012	800684	OFFICE ASSISTANT III	N	SR08	03	T	A	1.00	25,668	1.00	25,668
EDN100/AA	6/30/2012	801086	OFFICE ASSISTANT III	N	SR08	03	T	A	1.00	25,668	1.00	25,668
EDN100/AA	6/30/2012	800686	OFFICE ASSISTANT III	N	SR08	03	T	A	1.00	25,668	1.00	25,668
EDN100/AA	6/30/2012	802293	LIBRARY ASSISTANT II	N	SR05	03	T	A			1.00	25,668
EDN150/FA	6/30/2012	54726	EDUC ASST III	Y	SR12	03	P	A	1.00	27,154	1.00	26,010
EDN150/FA	6/30/2012	800587	EDUC ASST III	Y	SR12	03	T	A	1.00	27,154	1.00	26,010
EDN150/FA	6/30/2012	801285	EDUC ASST III	Y	SR12	03	T	A	1.00	29,368	1.00	28,130
EDN150/FA	6/30/2012	57168	EDUC ASST III	Y	SR12	03	T	A	1.00	29,368	1.00	28,130
EDN100/AA	6/30/2012	55782	EDUC ASST III	Y	SR12	03	P	A	1.00	30,506	1.00	29,220
EDN100/AA	6/30/2012	55276	OFFICE ASSISTANT III	N	SR08	03	T	A	1.00	30,036	1.00	30,036
EDN100/AA	6/30/2012	800009	EDUC ASST III	Y	SR12	03	T	A	1.00	30,036	1.00	30,036
EDN100/AA	6/30/2012	802395	EDUC ASST III	Y	SR12	03	T	A			1.00	30,036
EDN150/FA	6/30/2012	56040	EDUC ASST III	Y	SR12	03	T	A	1.00	31,212	1.00	31,212
EDN300/KO	6/30/2012	51563	PERSONNEL CLERK V	N	SR13	03	T	A			1.00	31,212

<u>Prog ID/Org</u>	<u>Separation Date</u>	<u>Position Number</u>	<u>Position Title</u>	<u>Exempt (Y/N)</u>	<u>SR Level</u>	<u>BU Code</u>	<u>T/P</u>	<u>MOF</u>	<u>Budgeted FTE</u>	<u>Budgeted Salary</u>	<u>Actual FTE</u>	<u>Actual Salary</u>
EDN150/FA	6/30/2012	34304	EDUC ASST III	Y	SR12	03	P	A	1.00	33,032	1.00	31,640
EDN100/AA	6/30/2012	45424	EDUC ASST III	Y	SR12	03	T	A	1.00	33,032	1.00	31,640
EDN100/CB	6/30/2012	801393	LEGAL CLERK	N	SR14	03	T	W			1.00	32,424
EDN150/FA	6/30/2012	54452	EDUC ASST III	Y	SR12	03	P	A	1.00	34,347	1.00	32,900
EDN100/AA	6/30/2012	16327	SCHOOL CUSTODIAN II	N	BC02	01	P	A	1.00	33,228	1.00	33,228
EDN400/MD	6/30/2012	9839	CAFETERIA HELPER	N	BC02	01	P	A			1.00	33,228
EDN100/AA	6/30/2012	54933	SCHOOL CUSTODIAN II	N	BC02	01	P	A	1.00	33,228	1.00	33,228
EDN100/AA	6/30/2012	35205	SCHOOL CUSTODIAN II	N	BC02	01	P	A	1.00	33,228	1.00	33,228
EDN100/AA	6/30/2012	16368	SCHOOL CUSTODIAN II	N	BC02	01	P	A	1.00	33,228	1.00	33,228
EDN100/AA	6/30/2012	16175	SCHOOL CUSTODIAN II	N	BC02	01	P	A	1.00	33,228	1.00	33,228
EDN100/AA	6/30/2012	14716	OFFICE ASSISTANT III	N	SR08	03	P	A	1.00	33,756	1.00	33,756
EDN100/AA	6/30/2012	16100	SCHOOL CUSTODIAN III	N	WS02	01	P	A	1.00	35,544	1.00	35,544
EDN400/MD	6/30/2012	10838	SCHOOL COOK II	N	BC06	01	P	A			1.00	38,436
EDN100/AA	6/30/2012	16150	SCHOOL CUSTODIAN V	N	F202	02	P	A	1.00	39,036	1.00	39,036
EDN150/YG	6/30/2012	801532	BEHAVIORAL HLTH SPCLT III	N	SR20	13	T	A			1.00	40,020
EDN100/AA	6/30/2012	60468	ELEM TEACHER	Certificated	T02	05	P	A	1.00	68,351	1.00	42,509
EDN100/AA	6/30/2012	62387	ELEM TEACHER	Certificated	T02	05	P	A	1.00	46,609	1.00	42,509
EDN200/GN	6/30/2012	801439	DISTRICT PCNC ASSISTANT	N	SR15	03	T	A			1.00	44,412
EDN100/DB	6/30/2012	79729	SECONDARY TEACHER	Certificated	T02	05	T	N			1.00	45,098
EDN150/SA	6/30/2012	56370	SPEECH PATHOLOGIST IV	Y	SR22	13	P	A	1.00	58,563	1.00	45,576
EDN100/AA	6/30/2012	800653	GEN PROF IV	N	SR22	13	T	A	1.00	45,576	1.00	45,576
EDN100/AA	6/30/2012	60365	SECONDARY TEACHER	Certificated	T03	05	P	A	1.00	68,351	1.00	45,909
EDN150/FA	6/30/2012	75865	SPEC ED TEACHER	Certificated	T03	05	P	A	1.00	79,170	1.00	45,909
EDN100/AA	6/30/2012	69610	SECONDARY TEACHER	Certificated	T04	05	P	A	1.00	44,452	1.00	47,746
EDN150/YC	6/30/2012	29155	SCHOOL PSYCHOLOGIST	Y	SR24	13	P	A	1.00	58,716	1.00	48,744
EDN400/MD	6/30/2012	9652	SCHOOL FOOD SERVICES MGR III	N	F206	02	P	A	1.00	50,376	1.00	49,056
EDN100/AA	6/30/2012	60329	ELEM TEACHER	Certificated	T04	05	P	A	1.00	40,567	1.00	49,179
EDN200/GN	6/30/2012	57947	ADMINISTRATIVE SERVICES ASST	N	SR22	13	P	A	1.00	49,332	1.00	49,332
EDN100/AA	6/30/2012	3838	SCHOOL ADM SERVICES ASST III	Certificated	SR16	04	P	A	1.00	49,932	1.00	49,932
EDN100/AA	6/30/2012	1885	SCHOOL ADM SERVICES ASST III	Certificated	SR16	04	P	A	1.00	49,932	1.00	49,932
EDN100/AA	6/30/2012	800681	ADMINISTRATIVE SERVICES ASST	N	SR22	13	T	A	1.00	51,312	1.00	51,312
EDN100/CB	6/30/2012	801026	PRGM SPCLT V	N	SR24	13	T	W			1.00	51,312
EDN100/AA	6/30/2012	1892	SCHOOL ADM SERVICES ASST IV	Certificated	SR18	04	P	A	1.00	54,012	1.00	54,012
EDN150/SA	6/30/2012	28717	OCC THERAPIST IV	N	SR22	13	P	A	1.00	63,648	1.00	55,500
EDN150/YC	6/30/2012	58409	BEHAVIORAL SPECIALIST IV	N	SR22	13	P	A	1.00	57,708	1.00	57,708
EDN100/AA	6/30/2012	61629	ELEM TEACHER	Certificated	T07	05	P	A	1.00	58,959	1.00	58,074
EDN150/SA	6/30/2012	33115	SPEECH PATHOLOGIST IV	Y	SR22	13	P	A	1.00	69,236	1.00	64,920
EDN100/AA	7/1/2012	52946	EDUC ASST II	Y	SR10	03	P	A	0.50	14,341	0.50	13,510
EDN100/AA	7/1/2012	45337	ACCOUNT CLERK II	N	SR08	03	P	A	0.50	14,418	0.50	14,418
EDN150/YG	7/1/2012	801524	EDUC ASST II	Y	SR10	03	T	A			1.00	23,130
EDN100/AA	7/1/2012	62023	COUNSELOR/ALIENATION	Certificated	T05	05	P	A	0.50	26,674	0.50	27,944
EDN100/AA	7/1/2012	72549	SECONDARY TEACHER	Certificated	T07	05	P	A	0.50	29,405	0.50	30,806
EDN150/FA	7/1/2012	67506	GEN EDUC/ARTICLE VI TCHR	Certificated	T02	05	P	A	1.00	44,813	1.00	32,222
EDN100/AA	7/1/2012	44131	LIBRARY ASSISTANT III	N	SR07	03	P	A	1.00	32,424	1.00	32,424
EDN150/FA	7/1/2012	76167	SPEC ED TEACHER	Certificated	T02	05	P	A	1.00	40,157	1.00	42,509

<u>Prog ID/Org</u>	<u>Separation Date</u>	<u>Position Number</u>	<u>Position Title</u>	<u>Exempt (Y/N)</u>	<u>SR Level</u>	<u>BU Code</u>	<u>T/P</u>	<u>MOF</u>	<u>Budgeted FTE</u>	<u>Budgeted Salary</u>	<u>Actual FTE</u>	<u>Actual Salary</u>
EDN150/FA	7/1/2012	74682	GEN EDUC/ARTICLE VI TCHR	Certificated	T02	05	P	A	1.00	40,285	1.00	42,509
EDN150/FA	7/1/2012	63335	SPEC ED TEACHER	Certificated	T02	05	P	A	1.00	40,157	1.00	42,509
EDN150/FA	7/1/2012	73922	SPEC ED TEACHER	Certificated	T02	05	P	A	1.00	46,011	1.00	42,509
EDN100/AA	7/1/2012	76259	ELEM TEACHER	Certificated	T02	05	P	A	1.00	44,030	1.00	42,509
EDN150/FA	7/1/2012	64063	SPEC ED TEACHER	Certificated	T02	05	P	A	1.00	42,602	1.00	42,509
EDN100/AA	7/1/2012	68490	SECONDARY TEACHER	Certificated	T02	05	P	A	1.00	40,577	1.00	42,509
EDN150/FA	7/1/2012	601753	SPEC ED TEACHER	Certificated	T02	05	T	A			1.00	42,509
EDN100/AA	7/1/2012	71879	ELEM TEACHER	Certificated	T02	05	P	A	1.00	43,822	1.00	42,509
EDN150/YG	7/1/2012	75390	12-MO DIST OFF TCHR	Certificated	T02	05	T	A	1.00	47,780	1.00	45,098
EDN150/FA	7/1/2012	74126	SPEC ED TEACHER	Certificated	T03	05	P	A	1.00	43,369	1.00	45,909
EDN150/FA	7/1/2012	600027	SPEC ED TEACHER	Certificated	T03	05	T	A			1.00	45,909
EDN150/FA	7/1/2012	67268	SPEC ED TEACHER	Certificated	T03	05	P	A	1.00	43,369	1.00	45,909
EDN150/FA	7/1/2012	74682	GEN EDUC/ARTICLE VI TCHR	Certificated	T03	05	P	A	1.00	40,285	1.00	45,909
EDN150/FA	7/1/2012	72113	SPEC ED TCHR/PRE-SCHOOL	Certificated	T03	05	P	A	1.00	52,960	1.00	45,909
EDN150/FA	7/1/2012	601886	SPEC ED TEACHER	Certificated	T03	05	T	A			1.00	45,909
EDN150/YG	7/1/2012	75418	12-MO DIST OFF TCHR	Certificated	T03	05	T	A	1.00	53,152	1.00	47,287
EDN150/FA	7/1/2012	69879	SPEC ED TEACHER	Certificated	T03	05	P	A	1.00	44,671	1.00	47,287
EDN150/FA	7/1/2012	65832	GEN EDUC/ARTICLE VI TCHR	Certificated	T03	05	P	A	1.00	48,003	1.00	48,706
EDN100/AA	7/1/2012	72666	SECONDARY TEACHER	Certificated	T03	05	P	A	1.00	46,492	1.00	48,706
EDN100/AA	7/1/2012	61298	SECONDARY TEACHER	Certificated	T03	05	P	A	1.00	46,492	1.00	48,706
EDN100/AA	7/1/2012	72280	SECONDARY TEACHER	Certificated	T03	05	T	A	1.00	46,492	1.00	48,706
EDN150/FA	7/1/2012	74566	SPEC ED TEACHER	Certificated	T03	05	P	A	1.00	46,011	1.00	48,706
EDN150/FA	7/1/2012	63392	12-MO SPEC ED TEACHER	Certificated	T03	05	P	A	1.00	55,213	1.00	48,706
EDN100/AA	7/1/2012	67272	SECONDARY TEACHER	Certificated	T03	05	P	A	1.00	46,492	1.00	48,706
EDN100/AA	7/1/2012	67931	SECONDARY TEACHER	Certificated	T04	05	P	A	1.00	41,794	1.00	49,179
EDN150/FA	7/1/2012	76061	SPEC ED TEACHER	Certificated	T03	05	P	A	1.00	48,813	1.00	51,673
EDN150/YG	7/1/2012	600984	DIST OFF TCHR	Certificated	T05	05	T	A			1.00	52,680
EDN100/AA	7/1/2012	74487	ELEM TEACHER	Certificated	T06	05	P	A	1.00	53,279	1.00	54,787
EDN100/AA	7/1/2012	62494	COUNSELOR	Certificated	T06	05	T	A	1.00	46,609	1.00	54,787
EDN100/AA	7/1/2012	71578	ELEM TEACHER	Certificated	T03	05	P	A	1.00	52,326	1.00	54,819
EDN400/OB	7/1/2012	60008	ASST SUPT,BUSINESS SVCS	N	E00	06	P	A	1.00	98,849	1.00	56,011
EDN150/FA	7/1/2012	61469	SPEC ED TEACHER	Certificated	T06	05	P	A	1.00	53,308	1.00	56,431
EDN100/AA	7/1/2012	63571	ELEM TEACHER	Certificated	T07	05	P	A	1.00	55,434	1.00	58,074
EDN150/NB	7/1/2012	79374	DIST OFF TCHR	Certificated	T06	05	T	N			1.00	58,124
EDN100/AA	7/1/2012	62016	ELEM TEACHER	Certificated	T05	05	P	A	1.00	58,295	1.00	61,071
EDN100/AA	7/1/2012	63789	12-MONTH REGISTRAR	Certificated	T04	05	P	A	1.00	75,898	1.00	62,299
EDN100/AA	7/1/2012	66596	ELEM TEACHER	Certificated	T07	05	P	A	1.00	61,557	1.00	63,460
EDN150/FA	7/1/2012	65566	GEN EDUC/ARTICLE VI TCHR	Certificated	T07	05	P	A	1.00	60,139	1.00	63,460
EDN100/AA	7/1/2012	65353	ELEM TEACHER	Certificated	T06	05	T	A	1.00	60,627	1.00	63,514
EDN100/AA	7/1/2012	63834	ELEM TEACHER	Certificated	T05	05	T	A	1.00	61,845	1.00	64,791
EDN100/AA	7/1/2012	62886	SECONDARY TEACHER	Certificated	T07	05	P	A	1.00	62,391	1.00	65,363
EDN100/AA	7/1/2012	601375	10-MO STUDENT SVCS COORD	Certificated	T05	05	T	A			1.00	66,733
EDN100/AA	7/1/2012	63845	ELEM TEACHER	Certificated	T07	05	P	A	1.00	65,247	1.00	67,325
EDN100/AA	7/1/2012	61488	ELEM TEACHER	Certificated	T07	05	P	A	1.00	64,264	1.00	67,325
EDN100/AA	7/1/2012	63671	ELEM TEACHER	Certificated	T07	05	P	A	1.00	66,191	1.00	69,344

<u>Prog ID/Org</u>	<u>Separation Date</u>	<u>Position Number</u>	<u>Position Title</u>	<u>Exempt (Y/N)</u>	<u>SR Level</u>	<u>BU Code</u>	<u>T/P</u>	<u>MOF</u>	<u>Budgeted FTE</u>	<u>Budgeted Salary</u>	<u>Actual FTE</u>	<u>Actual Salary</u>
EDN150/FA	7/1/2012	75600	GEN EDUC/ARTICLE VI TCHR	Certificated	T07	05	P	A	1.00	40,285	1.00	69,344
EDN100/AA	7/1/2012	61334	ELEM TEACHER	Certificated	T07	05	P	A	1.00	66,191	1.00	69,344
EDN100/AA	7/1/2012	63628	ELEM TEACHER	Certificated	T07	05	P	A	1.00	68,177	1.00	71,425
EDN100/AA	7/1/2012	62838	ELEM TEACHER	Certificated	T07	05	P	A	1.00	68,177	1.00	71,425
EDN100/AA	7/1/2012	64604	ELEM TEACHER	Certificated	T07	05	P	A	1.00	68,177	1.00	71,425
EDN100/AA	7/1/2012	63539	SECONDARY TEACHER	Certificated	T07	05	P	A	1.00	68,177	1.00	71,425
EDN100/AA	7/1/2012	601781	VICE PRINCIPAL I	Certificated	E03	06	T	A			1.00	72,040
EDN150/FA	7/1/2012	60778	SPEC ED TEACHER	Certificated	T06	05	P	A	1.00	69,496	1.00	73,567
EDN100/AA	7/1/2012	64971	SECONDARY TEACHER	Certificated	T06	05	P	A	1.00	70,222	1.00	73,567
EDN100/AA	7/1/2012	71247	ELEM TEACHER	Certificated	T07	05	P	A	1.00	70,222	1.00	73,567
EDN150/FA	7/1/2012	67430	SPEC ED TEACHER	Certificated	T07	05	P	A	1.00	69,496	1.00	73,567
EDN100/AA	7/1/2012	65935	SCH ATHLETIC DIR II	Certificated	E02	06	P	A	1.00	72,898	1.00	76,004
EDN100/AA	7/1/2012	71850	12-MONTH REGISTRAR	Certificated	T07	05	P	A	1.00	95,004	1.00	77,982
EDN100/AA	7/1/2012	66315	SECONDARY TEACHER	Certificated	T07	05	P	A	1.00	79,138	1.00	77,982
EDN100/AA	7/1/2012	68708	ELEM TEACHER	Certificated	T07	05	P	A	1.00	74,436	1.00	77,982
EDN100/AA	7/1/2012	66393	12-MO SECONDARY TEACHER	Certificated	T07	05	T	A	1.00	95,004	1.00	77,982
EDN150/YC	7/1/2012	601169	12-MO DIST OFF TCHR	Certificated	T07	05	T	A			1.00	77,982
EDN150/NB	7/1/2012	79825	12-MO DIST OFF TCHR	Certificated	T07	05	T	N			1.00	77,982
EDN100/DB	7/1/2012	600713	SECONDARY TEACHER	Certificated	T07	05	T	N			1.00	77,982
EDN100/AA	7/1/2012	64554	LIBRARIAN	Certificated	T07	05	P	A	1.00	80,465	1.00	77,982
EDN100/AA	7/1/2012	68301	COUNSELOR	Certificated	T07	05	P	A	1.00	79,170	1.00	77,982
EDN100/AA	7/1/2012	64460	SECONDARY TEACHER	Certificated	T07	05	P	A	1.00	79,138	1.00	77,982
EDN200/GN	7/1/2012	76295	DISTRICT EDUC SPEC II	Certificated	E07	06	T	A			1.00	83,772
EDN200/GN	7/1/2012	60084	COMPLX SCH RENEW SPEC II	Certificated	E07	06	P	A	1.00	93,739	1.00	83,772
EDN300/KF	7/1/2012	66414	ACCTG OPERATION SPEC III	Certificated	E08	06	P	A	1.00	72,207	1.00	87,340
EDN100/AA	7/1/2012	63441	VICE PRINCIPAL I	Certificated	E03	06	P	A	1.00	97,053	1.00	89,986
EDN100/AA	7/1/2012	65241	12-MO ELEM PRIN II	Certificated	E06	06	P	A	1.00	101,240	1.00	101,240
EDN100/BS	7/1/2012	73964	ROTC INSTRUCTOR	Certificated	ROTC	05	T	A	1.00	87,050	1.00	106,448
EDN200/GD	7/1/2012	74953F	EDUCATIONAL SPEC II	Certificated	E07	06	P	A	1.00	99,286	1.00	107,591
EDN150/NB	7/1/2012	600922	DISTRICT EDUC SPEC II	Certificated	E08	06	T	N			1.00	121,294
EDN100/DB	7/1/2012	60048	EDUC ADMIN SVCS DIRECTOR	Certificated	E10	06	T	A			1.00	123,642
EDN100/AA	7/1/2012	65878	12-MO HS PRIN VIII	Certificated	E11	06	P	A	1.00	135,564	1.00	135,564
EDN100/AA	7/1/2012	73628	12-MO MT INTER PRIN VII	Certificated	E10	06	P	A	1.00	164,359	1.00	149,417
EDN100/AA	7/1/2012	66200	12-MO HS PRIN VIII	Certificated	E11	06	P	A	1.00	149,417	1.00	149,417
EDN100/AA	7/3/2012	603023	SECONDARY TEACHER	Certificated	T03	05	T	A			0.50	23,643
EDN100/AA	7/4/2012	602509	ELEM TEACHER	Certificated	T03	05	T	A			1.00	45,909
EDN100/AA	7/6/2012	59989	OFFICE ASSISTANT II	N	SR06	03	T	A			1.00	12,301
EDN150/YG	7/7/2012	801525	EDUC ASST III	Y	SR12	03	T	A			1.00	25,030
EDN150/YC	7/10/2012	59940	BEHAVIORAL HLTH SPCLT IV	N	SR22	13	P	A	1.00	42,066	1.00	47,412
EDN100/AA	7/10/2012	73050	SECONDARY TEACHER	Certificated	T07	05	P	A	1.00	57,098	1.00	59,818
EDN100/AA	7/11/2012	71736	ELEM TEACHER	Certificated	T02	05	P	A	1.00	46,492	1.00	42,509
EDN150/FA	7/11/2012	73918	SPEC ED TEACHER	Certificated	T02	05	P	A	1.00	30,439	1.00	42,509
EDN150/SA	7/12/2012	801328	EDUCATIONAL INTERPRETER II	N	SR14	03	P	A	1.00	26,733	1.00	32,424
EDN100/AA	7/14/2012	18132	SCHOOL CUSTODIAN II	N	BC02	01	P	A	0.50	16,614	0.50	16,614
EDN100/AA	7/14/2012	18815	SCHOOL CUSTODIAN II	N	BC02	01	P	A	0.50	16,614	0.50	16,614

Prog ID/Org	Separation Date	Position Number	Position Title	Exempt (Y/N)	SR Level	BU Code	T/P	MOF	Budgeted FTE	Budgeted Salary	Actual FTE	Actual Salary
EDN150/FA	7/14/2012	56066	EDUC ASST III	Y	SR12	03	P	A	1.00	27,326	1.00	28,130
EDN150/FA	7/14/2012	57437	EDUC ASST III	Y	SR12	03	T	A	1.00	28,385	1.00	29,220
EDN400/MB	7/14/2012	36219	ACCOUNT CLERK IV	N	SR13	03	T	N	1.00	41,040	1.00	31,212
EDN100/BM	7/14/2012	800258	ATHLETIC HLTH CARE TRAINER	Y	SR22	13	P	A	1.00	42,073	1.00	45,576
EDN100/AA	7/14/2012	602309	SECONDARY TEACHER	Certificated	T03	05	T	A			1.00	45,909
EDN150/YC	7/14/2012	800430	SCHOOL PSYCHOLOGIST	Y	SR24	13	P	A	1.00	54,194	1.00	51,312
EDN150/YC	7/14/2012	29130	SCH PSYCH (DISTRICT-BASED)	Y	SR26	13	P	A	1.00	61,534	1.00	64,920
EDN150/FA	7/16/2012	72432	SPEC ED TEACHER	Certificated	T02	05	P	A	1.00	43,881	1.00	46,451
EDN200/GH	7/16/2012	64780	SECONDARY TEACHER	Certificated	T02	05	P	A	1.00	45,670	1.00	47,845
EDN150/FA	7/16/2012	69456	SPEC ED TEACHER	Certificated	T05	05	P	A	1.00	49,765	1.00	52,680
EDN150/YG	7/17/2012	800471	EDUC ASST III	Y	SR12	03	P	A	1.00	28,145	1.00	29,220
EDN100/AA	7/17/2012	61156	ELEM TEACHER	Certificated	T03	05	P	A	1.00	43,822	1.00	45,909
EDN150/YG	7/17/2012	600985	12-MO DIST OFF TCHR	Certificated	T03	05	P	A			1.00	47,287
EDN150/YC	7/17/2012	58508	BEHAVIORAL SPECIALIST IV	N	SR22	13	T	A	1.00	49,243	1.00	53,352
EDN150/YC	7/17/2012	58501	BEHAVIORAL HLTH SPCLT IV	N	SR22	13	P	A	1.00	53,264	1.00	57,708
EDN150/FA	7/18/2012	63974	SPEC ED TEACHER	Certificated	T03	05	P	A	1.00	46,011	1.00	47,287
EDN150/YC	7/19/2012	59148	BEHAVIORAL HLTH SPCLT IV	N	SR22	13	P	A	1.00	42,066	1.00	45,576
EDN100/AA	7/19/2012	69884	ELEM TEACHER	Certificated	T03	05	P	A	1.00	45,138	1.00	48,706
EDN400/OC	7/20/2012	18559	TRACTOR OPERATOR	N	BC04	01	P	A	1.00	34,971	1.00	35,544
EDN150/FA	7/20/2012	72127	SPEC ED TEACHER	Certificated	T02	05	P	A	1.00	41,362	1.00	37,893
EDN400/MD	7/20/2012	9780	SCHOOL FOOD SERVICES MGR II	N	F106	02	P	B			1.00	44,304
EDN100/AA	7/21/2012	29495	SCHOOL HEALTH AIDE	N	SR09	03	P	A	1.00	22,852	1.00	18,078
EDN150/NB	7/21/2012	58723	EDUC ASST III	Y	SR12	03	T	N			1.00	25,030
EDN100/AA	7/21/2012	59787	SCHOOL CUSTODIAN II	N	BC02	01	T	A	1.00	33,228	1.00	33,228
EDN100/DB	7/21/2012	79609	SECONDARY TEACHER	Certificated	T02	05	T	N			1.00	42,509
EDN150/YC	7/21/2012	58452	BEHAVIORAL HLTH SPCLT IV	N	SR22	13	P	A	1.00	42,066	1.00	45,576
EDN150/YG	7/21/2012	600919	12-MO DIST OFF TCHR	Certificated	T03	05	T	A			1.00	45,909
EDN100/AA	7/21/2012	64067	SECONDARY TEACHER	Certificated	T03	05	P	A	1.00	43,048	1.00	45,909
EDN100/AA	7/21/2012	74282	SECONDARY TEACHER	Certificated	T03	05	T	A	1.00	46,492	1.00	47,287
EDN150/FA	7/23/2012	74669	SPEC ED TEACHER	Certificated	T04	05	P	A	1.00	45,104	1.00	47,746
EDN150/FA	7/24/2012	800600	EDUC ASST III	Y	SR12	03	T	A	0.50	12,158	0.50	12,515
EDN150/FA	7/24/2012	57525	EDUC ASST III	Y	SR12	03	T	A	0.50	13,663	0.50	14,065
EDN150/FA	7/24/2012	56679	EDUC ASST II	Y	SR10	03	P	A	0.75	18,237	0.75	17,348
EDN150/FA	7/24/2012	800045	EDUC ASST II	Y	SR10	03	P	A			0.75	17,348
EDN100/AA	7/24/2012	29793	SCHOOL HEALTH AIDE	N	SR09	03	P	A	1.00	22,852	1.00	18,078
EDN150/FA	7/24/2012	58683	EDUC ASST III	Y	SR12	03	T	A	0.75	18,237	0.75	18,773
EDN150/FA	7/24/2012	800043	EDUC ASST III	Y	SR12	03	T	A	0.75	18,237	0.75	18,773
EDN150/FA	7/24/2012	57221	EDUC ASST III	Y	SR12	03	P	A	0.75	18,950	0.75	19,508
EDN100/AA	7/24/2012	801299	SCHOOL SECURITY ATTENDANT	N	SR07	03	T	A	1.00	21,444	1.00	20,540
EDN150/FA	7/24/2012	47139	EDUC ASST III	Y	SR12	03	P	A	0.75	20,495	0.75	21,097
EDN150/YG	7/24/2012	801859	EDUC ASST II	Y	SR10	03	T	A			1.00	23,130
EDN150/FA	7/24/2012	801864	EDUC ASST II	Y	SR10	03	T	A			1.00	23,130
EDN150/SA	7/24/2012	50751	HUMAN SVCS PROF IV	N	SR22	13	P	A	0.50	22,488	0.50	23,706
EDN150/YG	7/24/2012	801853	EDUC ASST III	Y	SR12	03	T	A			1.00	25,030
EDN150/YG	7/24/2012	800276	EDUC ASST III	Y	SR12	03	P	A	1.00	24,109	1.00	25,030

<u>Prog ID/Org</u>	<u>Separation Date</u>	<u>Position Number</u>	<u>Position Title</u>	<u>Exempt (Y/N)</u>	<u>SR Level</u>	<u>BU Code</u>	<u>T/P</u>	<u>MOF</u>	<u>Budgeted FTE</u>	<u>Budgeted Salary</u>	<u>Actual FTE</u>	<u>Actual Salary</u>
EDN150/FA	7/24/2012	801212	EDUC ASST III	Y	SR12	03	P	A	1.00	24,314	1.00	25,030
EDN150/FA	7/24/2012	56026	EDUC ASST III	Y	SR12	03	P	A	1.00	27,326	1.00	25,030
EDN150/FA	7/24/2012	57171	EDUC ASST III	Y	SR12	03	P	A	1.00	24,314	1.00	25,030
EDN150/YG	7/24/2012	801731	EDUC ASST III	Y	SR12	03	T	A			1.00	25,030
EDN150/FA	7/24/2012	801450	EDUC ASST III	Y	SR12	03	P	A	1.00	24,314	1.00	26,010
EDN150/YG	7/24/2012	800479	EDUC ASST III	Y	SR12	03	P	A	1.00	25,053	1.00	26,010
EDN150/FA	7/24/2012	800498	EDUC ASST III	Y	SR12	03	T	A	1.00	26,248	1.00	27,020
EDN150/FA	7/24/2012	57808	EDUC ASST III	Y	SR12	03	P	A	1.00	26,248	1.00	27,020
EDN150/FA	7/24/2012	29659	EDUC ASST II	Y	SR10	03	P	A	1.00	28,385	1.00	27,020
EDN150/FA	7/24/2012	53118	EDUC ASST III	Y	SR12	03	P	A	1.00	28,385	1.00	29,220
EDN150/FA	7/24/2012	57016	EDUC ASST III	Y	SR12	03	P	A	1.00	28,385	1.00	29,220
EDN200/GN	7/24/2012	58666	BILINGUAL/BICULTURAL S/H ASST	Y	SR11	03	T	A	1.00	29,453	1.00	32,424
EDN400/MD	7/24/2012	9426	SCHOOL BAKER	N	BC06	01	P	B	1.00	12,012	1.00	38,436
EDN100/AA	7/24/2012	67567	ELEM TEACHER	Certificated	T02	05	P	A	1.00	45,138	1.00	42,509
EDN150/FA	7/24/2012	71220	SPEC ED TEACHER	Certificated	T02	05	P	A	1.00	51,258	1.00	42,509
EDN100/AA	7/24/2012	65862	ELEM TEACHER	Certificated	T02	05	P	A	1.00	40,577	1.00	42,509
EDN150/FA	7/24/2012	62269	SPEC ED TCHR/PRE-SCHOOL	Certificated	T02	05	P	A	1.00	42,602	1.00	42,509
EDN100/AA	7/24/2012	68510	ELEM TEACHER	Certificated	T02	05	T	A	1.00	45,138	1.00	42,509
EDN100/AA	7/24/2012	61952	ELEM TEACHER	Certificated	T02	05	P	A	1.00	46,492	1.00	42,509
EDN150/FA	7/24/2012	75553	GEN EDUC/ARTICLE VI TCHR	Certificated	T02	05	T	A	1.00	58,387	1.00	42,509
EDN100/AA	7/24/2012	69616	ELEM TEACHER	Certificated	T02	05	P	A	1.00	70,222	1.00	42,509
EDN100/AA	7/24/2012	60522	ELEM TEACHER	Certificated	T02	05	P	A	1.00	64,264	1.00	42,509
EDN150/FA	7/24/2012	68517	GEN EDUC/ARTICLE VI TCHR	Certificated	T02	05	T	A	1.00	44,813	1.00	42,509
EDN100/AA	7/24/2012	71257	ELEM TEACHER	Certificated	T02	05	P	A	1.00	45,138	1.00	42,509
EDN150/FA	7/24/2012	63178	SPEC ED TEACHER	Certificated	T02	05	P	A	1.00	41,362	1.00	43,785
EDN150/FA	7/24/2012	601847	GEN EDUC/ARTICLE VI TCHR	Certificated	T02	05	T	A			1.00	43,785
EDN150/FA	7/24/2012	68786	SPEC ED TEACHER	Certificated	T02	05	P	A	1.00	46,011	1.00	43,785
EDN100/AA	7/24/2012	67562	SECONDARY TEACHER	Certificated	T02	05	T	A	1.00	43,048	1.00	45,098
EDN100/AA	7/24/2012	66740	SECONDARY TEACHER	Certificated	T02	05	P	A	1.00	43,048	1.00	45,098
EDN150/SA	7/24/2012	30414	SPEECH PATHOLOGIST IV	Y	SR22	13	P	A	1.00	63,937	1.00	45,576
EDN150/YG	7/24/2012	800948	BEHAVIORAL HLTH SPCLT IV	N	SR22	13	P	A	1.00	42,049	1.00	45,576
EDN150/SA	7/24/2012	33093	SPEECH PATHOLOGIST IV	Y	SR22	13	P	A	1.00	51,891	1.00	45,576
EDN150/SA	7/24/2012	800335	SPEECH PATHOLOGIST IV	Y	SR22	13	P	A	1.00	51,891	1.00	45,576
EDN150/SA	7/24/2012	46780	SPEECH PATHOLOGIST IV	Y	SR22	13	P	A	1.00	51,891	1.00	45,576
EDN100/AA	7/24/2012	600088	ELEM TEACHER	Certificated	T03	05	T	A			1.00	45,909
EDN150/FA	7/24/2012	74428	SPEC ED TEACHER	Certificated	T03	05	P	A	1.00	56,507	1.00	45,909
EDN150/FA	7/24/2012	74566	SPEC ED TEACHER	Certificated	T03	05	P	A	1.00	46,011	1.00	45,909
EDN100/AA	7/24/2012	602120	ELEM TEACHER	Certificated	T03	05	T	A			1.00	45,909
EDN150/FA	7/24/2012	69121	SPEC ED TEACHER	Certificated	T03	05	P	A	1.00	43,369	1.00	45,909
EDN150/FA	7/24/2012	75802	GEN EDUC/ARTICLE VI TCHR	Certificated	T03	05	P	A	1.00	42,738	1.00	45,909
EDN100/AA	7/24/2012	74149	SECONDARY TEACHER	Certificated	T03	05	T	A	1.00	44,452	1.00	45,909
EDN150/FA	7/24/2012	63828	SPEC ED TEACHER	Certificated	T03	05	P	A	1.00	30,439	1.00	45,909
EDN100/AA	7/24/2012	601235	ELEM TEACHER	Certificated	T03	05	T	A			1.00	45,909
EDN100/AA	7/24/2012	61364	ELEM TEACHER	Certificated	T03	05	P	A	1.00	66,191	1.00	45,909
EDN150/FA	7/24/2012	600521	GEN EDUC/ARTICLE VI TCHR	Certificated	T03	05	T	A			1.00	45,909

Department of Education
Personnel Separations

Table 15

Prog ID/Org	Separation Date	Position Number	Position Title	Exempt (Y/N)	SR Level	BU Code	T/P	MOF	Budgeted FTE	Budgeted Salary	Actual FTE	Actual Salary
EDN100/AA	7/24/2012	69390	SECONDARY TEACHER	Certificated	T03	05	P	A	1.00	43,822	1.00	45,909
EDN100/AA	7/24/2012	60253	COUNSELOR	Certificated	T03	05	P	A	1.00	70,400	1.00	45,909
EDN100/AA	7/24/2012	65897	SECONDARY TEACHER	Certificated	T03	05	P	A	1.00	43,822	1.00	45,909
EDN150/FA	7/24/2012	600159	SPEC ED TEACHER	Certificated	T03	05	T	A			1.00	45,909
EDN150/FA	7/24/2012	74101	SPEC ED TEACHER	Certificated	T03	05	P	A	1.00	46,011	1.00	47,287
EDN150/FA	7/24/2012	600787	SPEC ED TEACHER	Certificated	T03	05	T	A			1.00	47,287
EDN150/FA	7/24/2012	76166	SPEC ED TCHR/PRE-SCHOOL	Certificated	T03	05	P	A	1.00	70,468	1.00	47,287
EDN150/FA	7/24/2012	62858	GEN EDUC/ARTICLE VI TCHR	Certificated	T03	05	P	A	1.00	44,813	1.00	47,287
EDN100/AA	7/24/2012	75077	SECONDARY TEACHER	Certificated	T03	05	P	A	1.00	57,098	1.00	47,287
EDN150/FA	7/24/2012	74572	SPEC ED TEACHER	Certificated	T03	05	P	A	1.00	44,671	1.00	47,287
EDN150/SA	7/24/2012	30418	SPEECH PATHOLOGIST IV	Y	SR22	13	P	A	1.00	58,113	1.00	47,412
EDN100/AA	7/24/2012	74792	ELEM TEACHER	Certificated	T04	05	P	A	1.00	40,577	1.00	47,746
EDN150/FA	7/24/2012	62843	GEN EDUC/ARTICLE VI TCHR	Certificated	T04	05	P	A	1.00	45,248	1.00	47,746
EDN100/AA	7/24/2012	66973	SECONDARY TEACHER	Certificated	T03	05	P	A	1.00	46,492	1.00	48,706
EDN100/AA	7/24/2012	71342	ELEM TEACHER	Certificated	T03	05	P	A	1.00	46,492	1.00	48,706
EDN150/FA	7/24/2012	71961	SPEC ED TEACHER	Certificated	T04	05	P	A			1.00	50,654
EDN100/DB	7/24/2012	600202	ELEM TEACHER	Certificated	T05	05	T	N			1.00	52,680
EDN100/AA	7/24/2012	73233	SECONDARY TEACHER	Certificated	T05	05	T	A	1.00	40,577	1.00	52,680
EDN100/AA	7/24/2012	71730	ELEM TEACHER	Certificated	T05	05	P	A	1.00	49,334	1.00	52,680
EDN150/FA	7/24/2012	602090	GEN EDUC/ARTICLE VI TCHR	Certificated	T05	05	T	A			1.00	52,680
EDN150/FA	7/24/2012	63273	GEN EDUC/ARTICLE VI TCHR	Certificated	T06	05	T	A	1.00	46,605	1.00	53,191
EDN150/SA	7/24/2012	27262	SPEECH PATHOLOGIST IV	Y	SR22	13	P	A	1.00	60,973	1.00	53,352
EDN100/AA	7/24/2012	65698	ELEM TEACHER	Certificated	T06	05	P	A	1.00	46,492	1.00	54,787
EDN100/AA	7/24/2012	61628	ELEM TEACHER	Certificated	T07	05	P	A	1.00	57,098	1.00	59,818
EDN150/SA	7/25/2012	51213	COMMUNICATION AIDE	Y	SR12	03	P	A	0.50	12,525	0.50	12,515
EDN150/FA	7/25/2012	57242	EDUC ASST III	Y	SR12	03	T	A	0.75	18,237	0.75	18,773
EDN150/FA	7/25/2012	30137	EDUC ASST III	Y	SR12	03	P	A	0.75	21,289	0.75	18,773
EDN150/FA	7/25/2012	57229	EDUC ASST III	Y	SR12	03	T	A	0.75	18,237	0.75	18,773
EDN150/FA	7/25/2012	40840	EDUC ASST III	Y	SR12	03	P	A	0.75	24,917	0.75	18,773
EDN150/FA	7/25/2012	800928	EDUC ASST III	Y	SR12	03	T	A	0.75	18,237	0.75	18,773
EDN150/NB	7/25/2012	800674	EDUC ASST III	Y	SR12	03	T	N			0.75	19,508
EDN150/FA	7/25/2012	48794	EDUC ASST II	Y	SR10	03	T	A	1.00	28,385	1.00	23,130
EDN150/FA	7/25/2012	57147	EDUC ASST II	Y	SR10	03	T	A			1.00	23,130
EDN100/AA	7/25/2012	76284	SECONDARY TEACHER	Certificated	T03	05	T	A	1.00	33,217	0.50	23,643
EDN150/FA	7/25/2012	800662	EDUC ASST III	Y	SR12	03	P	A	1.00	24,314	1.00	23,780
EDN150/FA	7/25/2012	801887	EDUC ASST III	Y	SR12	03	T	A			1.00	25,030
EDN150/FA	7/25/2012	47132	EDUC ASST III	Y	SR12	03	P	A	1.00	24,314	1.00	25,030
EDN150/FA	7/25/2012	56957	EDUC ASST III	Y	SR12	03	T	A	1.00	24,314	1.00	25,030
EDN100/AA	7/25/2012	55788	EDUC ASST III	Y	SR12	03	P	A	1.00	30,506	1.00	25,030
EDN100/AA	7/25/2012	33150	SCHOOL SECURITY ATTENDANT	N	SR07	03	P	A	1.00	28,209	1.00	25,670
EDN150/FA	7/25/2012	55152	EDUC ASST III	Y	SR12	03	P	A	1.00	26,248	1.00	27,020
EDN150/FA	7/25/2012	42036	EDUC ASST III	Y	SR12	03	P	A	1.00	29,561	1.00	30,430
EDN100/AA	7/25/2012	600736	SECONDARY TEACHER	Certificated	T02	05	T	A			1.00	32,222
EDN150/FB	7/25/2012	602861	SPECIAL SCH TEACHER	Certificated	T02	05	P	A			1.00	37,893
EDN100/DB	7/25/2012	801087	DATA PROCSSG SYSTS ANAL II	N	SR18	13	T	N			1.00	38,988

<u>Prog ID/Org</u>	<u>Separation Date</u>	<u>Position Number</u>	<u>Position Title</u>	<u>Exempt (Y/N)</u>	<u>SR Level</u>	<u>BU Code</u>	<u>T/P</u>	<u>MOF</u>	<u>Budgeted FTE</u>	<u>Budgeted Salary</u>	<u>Actual FTE</u>	<u>Actual Salary</u>
EDN150/FA	7/25/2012	63536	SPEC ED TEACHER	Certificated	T02	05	T	A	1.00	40,157	1.00	42,509
EDN150/FA	7/25/2012	69259	SPEC ED TEACHER	Certificated	T02	05	P	A	1.00	40,157	1.00	42,509
EDN150/FA	7/25/2012	62115	SPEC ED TEACHER	Certificated	T02	05	P	A			1.00	42,509
EDN150/FA	7/25/2012	68455	GEN EDUC/ARTICLE VI TCHR	Certificated	T02	05	P	A	1.00	37,867	1.00	42,509
EDN100/AA	7/25/2012	66548	ELEM TEACHER	Certificated	T02	05	P	A	1.00	53,348	1.00	42,509
EDN150/FA	7/25/2012	74181	SPEC ED TEACHER	Certificated	T02	05	P	A	1.00	43,369	1.00	42,509
EDN100/AA	7/25/2012	62264	ELEM TEACHER	Certificated	T02	05	P	A	1.00	41,794	1.00	43,785
EDN150/SA	7/25/2012	12065	SOCIAL WORKER IV	N	SR22	13	P	A	1.00	43,235	1.00	45,576
EDN150/FA	7/25/2012	71902	SPEC ED TEACHER	Certificated	T03	05	P	A	1.00	30,439	1.00	45,909
EDN100/AA	7/25/2012	63182	SECONDARY TEACHER	Certificated	T03	05	P	A	1.00	43,822	1.00	45,909
EDN150/FA	7/25/2012	76325	SPEC ED TEACHER	Certificated	T03	05	P	A	1.00	37,747	1.00	45,909
EDN150/FA	7/25/2012	68485	SPEC ED TEACHER	Certificated	T03	05	P	A	1.00	37,747	1.00	45,909
EDN100/AA	7/25/2012	62520	SECONDARY TEACHER	Certificated	T03	05	P	A	1.00	50,285	1.00	48,706
EDN100/AA	7/25/2012	72361	SECONDARY TEACHER	Certificated	T03	05	P	A	1.00	46,492	1.00	48,706
EDN100/AA	7/25/2012	60331	ELEM TEACHER	Certificated	T04	05	P	A	1.00	45,138	1.00	50,654
EDN100/AA	7/25/2012	60609	ELEM TEACHER	Certificated	T06	05	P	A	1.00	43,822	1.00	56,431
EDN150/FA	7/25/2012	68140	SPEC ED TEACHER	Certificated	T07	05	P	A	1.00	54,860	1.00	58,074
EDN100/AA	7/26/2012	63175	SECONDARY TEACHER	Certificated	T02	05	P	A	1.00	46,492	0.50	16,111
EDN150/FA	7/26/2012	57415	EDUC ASST II	Y	SR10	03	P	A	0.75	18,237	0.75	17,348
EDN100/AA	7/26/2012	602400	SECONDARY TEACHER	Certificated	T03	05	T	A			0.50	17,400
EDN100/AA	7/26/2012	602431	ELEM TEACHER	Certificated	T02	05	T	A			0.50	21,255
EDN100/AA	7/26/2012	600416	ELEM TEACHER	Certificated	T03	05	T	A			0.50	22,955
EDN100/AA	7/26/2012	602463	COUNSELOR	Certificated	T03	05	T	A			0.50	22,955
EDN100/AA	7/26/2012	69467	SECONDARY TEACHER	Certificated	T03	05	P	A	0.50	22,569	0.50	23,643
EDN100/AA	7/26/2012	66033	ELEM TEACHER	Certificated	T03	05	P	A	1.00	58,716	0.50	23,643
EDN150/FA	7/26/2012	72159	SPEC ED TCHR/PRE-SCHOOL	Certificated	T01	05	P	A	1.00	54,860	1.00	29,662
EDN100/AA	7/26/2012	61037	ELEM TEACHER	Certificated	T07	05	P	A	1.00	50,285	0.50	29,909
EDN150/FA	7/26/2012	71035	SPEC ED TEACHER	Certificated	T02	05	P	A	1.00	30,439	1.00	32,222
EDN100/AA	7/26/2012	68450	SECONDARY TEACHER	Certificated	T02	05	P	A	1.00	45,138	1.00	32,222
EDN150/FA	7/26/2012	72252	SPEC ED TEACHER	Certificated	T02	05	P	A	1.00	44,671	1.00	32,222
EDN150/FA	7/26/2012	62720	SPEC ED TEACHER	Certificated	T02	05	P	A	1.00	37,747	1.00	32,222
EDN150/FA	7/26/2012	75902	GEN EDUC/ARTICLE VI TCHR	Certificated	T02	05	P	A	1.00	48,313	1.00	32,222
EDN100/AA	7/26/2012	67191	SECONDARY TEACHER	Certificated	T02	05	P	A	1.00	43,822	1.00	32,222
EDN100/AA	7/26/2012	66842	SECONDARY TEACHER	Certificated	T02	05	T	A	1.00	38,142	1.00	32,222
EDN150/FA	7/26/2012	61465	SPEC ED TEACHER	Certificated	T02	05	P	A	1.00	46,011	1.00	32,222
EDN150/FA	7/26/2012	66994	SPEC ED TEACHER	Certificated	T02	05	P	A	1.00	46,011	1.00	32,222
EDN150/FA	7/26/2012	62337	SPEC ED TEACHER	Certificated	T02	05	P	A	1.00	43,369	1.00	32,222
EDN100/BV	7/26/2012	65378	ELEM TEACHER	Certificated	T02	05	T	A			1.00	32,222
EDN150/FA	7/26/2012	602342	SPEC ED TEACHER	Certificated	T02	05	T	A			1.00	32,222
EDN100/AA	7/26/2012	62855	SECONDARY TEACHER	Certificated	T02	05	P	A	1.00	58,316	1.00	32,222
EDN150/FA	7/26/2012	68797	SPEC ED TEACHER	Certificated	T02	05	P	A	1.00	33,967	1.00	32,222
EDN100/AA	7/26/2012	64629	SECONDARY TEACHER	Certificated	T02	05	P	A	1.00	30,757	1.00	32,222
EDN100/AA	7/26/2012	602393	SPEC ED TEACHER	Certificated	T02	05	T	A			1.00	32,222
EDN150/FA	7/26/2012	62510	SPEC ED TEACHER	Certificated	T02	05	P	A	1.00	59,999	1.00	32,222
EDN100/AA	7/26/2012	68788	SECONDARY TEACHER	Certificated	T02	05	P	A	1.00	50,285	1.00	32,222

Department of Education
Personnel Separations

Table 15

<u>Prog ID/Org</u>	<u>Separation Date</u>	<u>Position Number</u>	<u>Position Title</u>	<u>Exempt (Y/N)</u>	<u>SR Level</u>	<u>BU Code</u>	<u>T/P</u>	<u>MOF</u>	<u>Budgeted FTE</u>	<u>Budgeted Salary</u>	<u>Actual FTE</u>	<u>Actual Salary</u>
EDN150/FA	7/26/2012	71499	SPEC ED TCHR/PRE-SCHOOL	Certificated	T02	05	P	A	1.00	54,860	1.00	32,222
EDN150/FA	7/26/2012	76046	SPEC ED TEACHER	Certificated	T02	05	P	A	1.00	46,011	1.00	32,222
EDN100/AA	7/26/2012	69555	SECONDARY TEACHER	Certificated	T02	05	T	A	1.00	48,351	1.00	32,222
EDN150/FA	7/26/2012	63200	SPEC ED TEACHER	Certificated	T02	05	P	A	1.00	43,369	1.00	32,222
EDN150/FA	7/26/2012	600191	SPEC ED TEACHER	Certificated	T02	05	T	A			1.00	32,222
EDN150/FA	7/26/2012	73738	SPEC ED TEACHER	Certificated	T02	05	P	A	1.00	37,747	1.00	32,222
EDN150/FA	7/26/2012	68309	SPEC ED TEACHER	Certificated	T02	05	P	A			1.00	32,222
EDN100/AA	7/26/2012	73053	COUNSELOR	Certificated	T02	05	P	A	1.00	48,008	1.00	32,222
EDN150/NB	7/26/2012	600606	DIST OFF TCHR	Certificated	T02	05	T	N			1.00	32,222
EDN150/FA	7/26/2012	64326	SPEC ED TEACHER	Certificated	T02	05	P	A	1.00	46,011	1.00	32,222
EDN100/AA	7/26/2012	601437	SECONDARY TEACHER	Certificated	T02	05	T	A			1.00	32,222
EDN100/AA	7/26/2012	66805	SECONDARY TEACHER	Certificated	T02	05	P	A	1.00	33,217	1.00	32,222
EDN100/AA	7/26/2012	66723	SECONDARY TEACHER	Certificated	T02	05	P	A	1.00	30,757	1.00	32,222
EDN150/FA	7/26/2012	66937	SPEC ED TCHR/PRE-SCHOOL	Certificated	T02	05	P	A	1.00	41,362	1.00	32,222
EDN100/AA	7/26/2012	64778	SECONDARY TEACHER	Certificated	T02	05	P	A	1.00	47,398	1.00	32,222
EDN100/AA	7/26/2012	69001	SECONDARY TEACHER	Certificated	T02	05	P	A	1.00	40,577	1.00	32,222
EDN150/FA	7/26/2012	71940	SPEC ED TEACHER	Certificated	T02	05	P	A	1.00	30,439	1.00	32,222
EDN100/AA	7/26/2012	63817	SECONDARY TEACHER	Certificated	T02	05	P	A	1.00	40,577	1.00	32,222
EDN150/FA	7/26/2012	73209	SPEC ED TEACHER	Certificated	T02	05	P	A	1.00	51,970	1.00	32,222
EDN100/AA	7/26/2012	601717	SECONDARY TEACHER	Certificated	T02	05	T	A			1.00	32,222
EDN100/AA	7/26/2012	63023	SECONDARY TEACHER	Certificated	T02	05	P	A	1.00	51,400	1.00	32,222
EDN100/BJ	7/26/2012	73082	SPECIAL SCH TEACHER	Certificated	T02	05	P	A	1.00	30,072	1.00	32,222
EDN100/AA	7/26/2012	63067	SECONDARY TEACHER	Certificated	T02	05	P	A	1.00	66,143	1.00	32,222
EDN150/FA	7/26/2012	74107	SPEC ED TCHR/PRE-SCHOOL	Certificated	T02	05	P	A			1.00	32,222
EDN150/FA	7/26/2012	64006	SPEC ED TEACHER	Certificated	T02	05	P	A	1.00	49,286	1.00	32,222
EDN150/FA	7/26/2012	65943	GEN EDUC/ARTICLE VI TCHR	Certificated	T02	05	P	A	1.00	43,507	1.00	32,222
EDN100/BX	7/26/2012	73011	TEACHER/DORMITORY	Certificated	T02	05	P	A	1.00	42,380	1.00	32,222
EDN100/AA	7/26/2012	602243	SECONDARY TEACHER	Certificated	T02	05	T	A			1.00	32,222
EDN100/AA	7/26/2012	602408	10-MONTH SAC TEACHER	Certificated	T02	05	T	A			1.00	32,222
EDN150/FA	7/26/2012	74653	SPEC ED TEACHER	Certificated	T02	05	P	A	1.00	48,363	1.00	32,222
EDN150/FA	7/26/2012	65253	GEN EDUC/ARTICLE VI TCHR	Certificated	T02	05	P	A	1.00	43,713	1.00	32,222
EDN100/AA	7/26/2012	63410	SECONDARY TEACHER	Certificated	T02	05	P	A	1.00	53,897	1.00	32,222
EDN100/AA	7/26/2012	63669	SECONDARY TEACHER	Certificated	T02	05	P	A	1.00	46,492	1.00	32,222
EDN150/FA	7/26/2012	76321	SPEC ED TCHR/PRE-SCHOOL	Certificated	T03	05	P	A	1.00	56,507	1.00	34,799
EDN150/FA	7/26/2012	75583	GEN EDUC/ARTICLE VI TCHR	Certificated	T03	05	T	A			1.00	34,799
EDN100/AA	7/26/2012	600327	SECONDARY TEACHER	Certificated	T03	05	T	A			1.00	34,799
EDN100/AA	7/26/2012	63159	SECONDARY TEACHER	Certificated	T03	05	T	A	1.00	43,157	1.00	34,799
EDN150/FA	7/26/2012	69052	SPEC ED TEACHER	Certificated	T02	05	P	A	1.00	47,851	1.00	39,958
EDN100/AA	7/26/2012	600140	SECONDARY TEACHER	Certificated	T02	05	T	A			1.00	39,958
EDN100/AA	7/26/2012	62313	SECONDARY TEACHER	Certificated	T02	05	P	A	1.00	60,627	1.00	39,958
EDN100/AA	7/26/2012	63869	ELEM TEACHER	Certificated	T02	05	P	A	1.00	54,419	1.00	39,958
EDN100/AA	7/26/2012	62455	SECONDARY TEACHER	Certificated	T02	05	P	A	1.00	48,351	1.00	39,958
EDN100/AA	7/26/2012	64937	SECONDARY TEACHER	Certificated	T02	05	P	A	1.00	43,822	1.00	39,958
EDN100/AA	7/26/2012	72022	SECONDARY TEACHER	Certificated	T02	05	P	A	1.00	38,142	1.00	39,958
EDN150/FA	7/26/2012	64165	GEN EDUC/ARTICLE VI TCHR	Certificated	T02	05	P	A	1.00	43,507	1.00	39,958

<u>Prog ID/Org</u>	<u>Separation Date</u>	<u>Position Number</u>	<u>Position Title</u>	<u>Exempt (Y/N)</u>	<u>SR Level</u>	<u>BU Code</u>	<u>T/P</u>	<u>MOF</u>	<u>Budgeted FTE</u>	<u>Budgeted Salary</u>	<u>Actual FTE</u>	<u>Actual Salary</u>
EDN100/AA	7/26/2012	71128	ELEM TEACHER	Certificated	T02	05	P	A	1.00	48,820	1.00	39,958
EDN150/FA	7/26/2012	64480	GEN EDUC/ARTICLE VI TCHR	Certificated	T02	05	T	A	1.00	42,738	1.00	39,958
EDN100/AA	7/26/2012	69226	SECONDARY TEACHER	Certificated	T02	05	T	A	1.00	53,514	1.00	39,958
EDN100/AA	7/26/2012	66515	SECONDARY TEACHER	Certificated	T02	05	P	A	1.00	50,285	1.00	39,958
EDN100/AA	7/26/2012	65247	ELEM TEACHER	Certificated	T02	05	P	A	1.00	52,776	1.00	39,958
EDN150/FA	7/26/2012	67250	SPEC ED TEACHER	Certificated	T02	05	T	A	1.00	40,157	1.00	39,958
EDN100/AA	7/26/2012	601852	ELEM TEACHER	Certificated	T02	05	T	A			1.00	39,958
EDN100/AA	7/26/2012	73712	SECONDARY TEACHER	Certificated	T02	05	P	A	1.00	64,264	1.00	39,958
EDN150/FA	7/26/2012	75661	SPEC ED TEACHER	Certificated	T02	05	T	A	1.00	40,157	1.00	39,958
EDN150/FA	7/26/2012	73942	SPEC ED TEACHER	Certificated	T02	05	P	A			1.00	39,958
EDN100/AA	7/26/2012	602251	SECONDARY TEACHER	Certificated	T02	05	T	A			1.00	39,958
EDN100/AA	7/26/2012	600432	ELEM TEACHER	Certificated	T02	05	T	A			1.00	39,958
EDN100/AA	7/26/2012	71955	SECONDARY TEACHER	Certificated	T02	05	P	A	1.00	40,577	1.00	39,958
EDN150/FA	7/26/2012	73408	SPEC ED TEACHER	Certificated	T02	05	P	A	1.00	40,157	1.00	42,509
EDN150/FA	7/26/2012	66236	SPEC ED TEACHER	Certificated	T02	05	P	A	1.00	41,362	1.00	42,509
EDN100/AA	7/26/2012	74297	SECONDARY TEACHER	Certificated	T02	05	P	A	1.00	41,794	1.00	42,509
EDN100/AA	7/26/2012	601427	SECONDARY TEACHER	Certificated	T02	05	T	A			1.00	42,509
EDN150/FA	7/26/2012	66439	GEN EDUC/ARTICLE VI TCHR	Certificated	T02	05	P	A	1.00	48,003	1.00	42,509
EDN150/FA	7/26/2012	61017	SPEC ED TEACHER	Certificated	T02	05	P	A	1.00	43,507	1.00	42,509
EDN150/FA	7/26/2012	602460	GEN EDUC/ARTICLE VI TCHR	Certificated	T02	05	T	A			1.00	42,509
EDN150/FA	7/26/2012	69196	SPEC ED TEACHER	Certificated	T02	05	P	A	1.00	40,157	1.00	42,509
EDN150/FA	7/26/2012	602345	GEN EDUC/ARTICLE VI TCHR	Certificated	T02	05	T	A			1.00	42,509
EDN150/FA	7/26/2012	73975	SPEC ED TEACHER	Certificated	T02	05	T	A	1.00	43,369	1.00	42,509
EDN150/FA	7/26/2012	72812	SPEC ED TEACHER	Certificated	T02	05	P	A	1.00	30,439	1.00	42,509
EDN150/FA	7/26/2012	60117	GEN EDUC/ARTICLE VI TCHR	Certificated	T02	05	P	A	1.00	41,260	1.00	42,509
EDN100/AA	7/26/2012	60192	ELEM TEACHER	Certificated	T02	05	P	A	1.00	62,391	1.00	42,509
EDN150/FA	7/26/2012	73906	SPEC ED TEACHER	Certificated	T02	05	P	A	1.00	40,157	1.00	42,509
EDN100/AA	7/26/2012	600844	SECONDARY TEACHER	Certificated	T02	05	T	A			1.00	42,509
EDN100/AA	7/26/2012	62897	SECONDARY TEACHER	Certificated	T02	05	P	A	1.00	43,822	1.00	42,509
EDN100/AA	7/26/2012	60155	ELEM TEACHER	Certificated	T02	05	P	A	1.00	65,247	1.00	42,509
EDN100/AA	7/26/2012	72266	ELEM TEACHER	Certificated	T02	05	P	A	1.00	43,048	1.00	42,509
EDN100/AA	7/26/2012	68461	SECONDARY TEACHER	Certificated	T02	05	P	A	1.00	47,039	1.00	42,509
EDN100/DB	7/26/2012	79804	ELEM TEACHER	Certificated	T02	05	T	N			1.00	42,509
EDN150/FA	7/26/2012	601233	SPEC ED TCHR/PRE-SCHOOL	Certificated	T02	05	T	A			1.00	42,509
EDN150/FB	7/26/2012	75020	SPECIAL SCH TEACHER	Certificated	T02	05	P	A	1.00	39,795	1.00	42,509
EDN150/FA	7/26/2012	72305	SPEC ED TEACHER	Certificated	T02	05	T	A	1.00	44,671	1.00	42,509
EDN150/FA	7/26/2012	73891	SPEC ED TCHR/PRE-SCHOOL	Certificated	T02	05	P	A	1.00	43,369	1.00	42,509
EDN100/AA	7/26/2012	602468	ELEM TEACHER	Certificated	T02	05	T	A			1.00	42,509
EDN150/FA	7/26/2012	74421	SPEC ED TEACHER	Certificated	T02	05	T	A	1.00	40,157	1.00	42,509
EDN150/FA	7/26/2012	61613	SPEC ED TEACHER	Certificated	T02	05	P	A	1.00	59,999	1.00	42,509
EDN100/AA	7/26/2012	600325	SECONDARY TEACHER	Certificated	T02	05	T	A			1.00	42,509
EDN100/AA	7/26/2012	66174	SECONDARY TEACHER	Certificated	T02	05	P	A	1.00	40,577	1.00	42,509
EDN100/AA	7/26/2012	600090	ELEM TEACHER	Certificated	T02	05	T	A			1.00	42,509
EDN100/AA	7/26/2012	601927	ELEM TEACHER	Certificated	T02	05	T	A			1.00	42,509
EDN100/AA	7/26/2012	61853	ELEM TEACHER	Certificated	T02	05	T	A	1.00	43,822	1.00	42,509

<u>Prog ID/Org</u>	<u>Separation Date</u>	<u>Position Number</u>	<u>Position Title</u>	<u>Exempt (Y/N)</u>	<u>SR Level</u>	<u>BU Code</u>	<u>T/P</u>	<u>MOF</u>	<u>Budgeted FTE</u>	<u>Budgeted Salary</u>	<u>Actual FTE</u>	<u>Actual Salary</u>
EDN100/AA	7/26/2012	65650	SECONDARY TEACHER	Certificated	T02	05	T	A	1.00	46,492	1.00	42,509
EDN150/FA	7/26/2012	73794	SPEC ED TEACHER	Certificated	T02	05	P	A	1.00	46,011	1.00	42,509
EDN150/FA	7/26/2012	71151	SPEC ED TEACHER	Certificated	T02	05	P	A	1.00	40,157	1.00	42,509
EDN100/AA	7/26/2012	63241	SECONDARY TEACHER	Certificated	T02	05	P	A	1.00	57,145	1.00	42,509
EDN150/FA	7/26/2012	72762	SPEC ED TEACHER	Certificated	T02	05	P	A	1.00	43,369	1.00	42,509
EDN150/FA	7/26/2012	73938	SPEC ED TEACHER	Certificated	T02	05	P	A	1.00	40,157	1.00	42,509
EDN150/FA	7/26/2012	63857	SPEC ED TEACHER	Certificated	T02	05	P	A	1.00	40,157	1.00	42,509
EDN100/AA	7/26/2012	66382	SECONDARY TEACHER	Certificated	T02	05	P	A	1.00	40,577	1.00	42,509
EDN150/FA	7/26/2012	73093	SPEC ED TEACHER	Certificated	T02	05	P	A	1.00	40,157	1.00	42,509
EDN100/AA	7/26/2012	63648	SECONDARY TEACHER	Certificated	T02	05	P	A	1.00	56,416	1.00	42,509
EDN150/FA	7/26/2012	76329	SPEC ED TCHR/PRE-SCHOOL	Certificated	T02	05	P	A	1.00	41,362	1.00	42,509
EDN150/FA	7/26/2012	76330	SPEC ED TEACHER	Certificated	T02	05	P	A	1.00	40,157	1.00	42,509
EDN100/AA	7/26/2012	65244	SECONDARY TEACHER	Certificated	T02	05	P	A	1.00	38,142	1.00	42,509
EDN100/AA	7/26/2012	73767	SECONDARY TEACHER	Certificated	T02	05	P	A	1.00	40,577	1.00	42,509
EDN100/AA	7/26/2012	602392	ELEM TEACHER	Certificated	T02	05	T	A			1.00	42,509
EDN150/FA	7/26/2012	71992	SPEC ED TEACHER	Certificated	T02	05	P	A	1.00	40,157	1.00	42,509
EDN100/AA	7/26/2012	601436	SECONDARY TEACHER	Certificated	T02	05	T	A			1.00	42,509
EDN100/AA	7/26/2012	64594	SECONDARY TEACHER	Certificated	T02	05	P	A	1.00	53,514	1.00	42,509
EDN150/FA	7/26/2012	601946	GEN EDUC/ARTICLE VI TCHR	Certificated	T02	05	T	A			1.00	42,509
EDN150/NB	7/26/2012	79449	DIST OFF TCHR	Certificated	T02	05	T	N			1.00	42,509
EDN150/FA	7/26/2012	63990	SPEC ED TEACHER	Certificated	T02	05	P	A	1.00	44,341	1.00	42,509
EDN100/AA	7/26/2012	63806	ELEM TEACHER	Certificated	T02	05	P	A	1.00	58,810	1.00	42,509
EDN150/FA	7/26/2012	60386	SPEC ED TCHR/PRE-SCHOOL	Certificated	T02	05	T	A	1.00	40,157	1.00	42,509
EDN150/FA	7/26/2012	63913	GEN EDUC/ARTICLE VI TCHR	Certificated	T02	05	P	A	1.00	40,285	1.00	42,509
EDN100/AA	7/26/2012	64646	ELEM TEACHER	Certificated	T02	05	T	A	1.00	43,822	1.00	42,509
EDN150/FA	7/26/2012	72337	SPEC ED TEACHER	Certificated	T02	05	P	A	1.00	47,133	1.00	42,509
EDN150/FA	7/26/2012	73210	SPEC ED TEACHER	Certificated	T02	05	P	A	1.00	42,602	1.00	42,509
EDN100/AA	7/26/2012	64804	SECONDARY TEACHER	Certificated	T02	05	P	A	1.00	70,222	1.00	42,509
EDN150/FA	7/26/2012	601891	SPEC ED TEACHER	Certificated	T02	05	T	A			1.00	42,509
EDN150/FA	7/26/2012	69857	GEN EDUC/ARTICLE VI TCHR	Certificated	T02	05	P	A	1.00	50,927	1.00	42,509
EDN150/FA	7/26/2012	601294	SPEC ED TEACHER	Certificated	T02	05	T	A			1.00	42,509
EDN150/FA	7/26/2012	68854	SPEC ED TEACHER	Certificated	T02	05	P	A	1.00	40,157	1.00	42,509
EDN150/NB	7/26/2012	602355	SPEC ED TEACHER	Certificated	T02	05	T	N			1.00	42,509
EDN100/AA	7/26/2012	69872	ELEM TEACHER	Certificated	T02	05	P	A	1.00	46,492	1.00	42,509
EDN100/AA	7/26/2012	65819	SECONDARY TEACHER	Certificated	T02	05	P	A	1.00	74,436	1.00	42,509
EDN100/AA	7/26/2012	67755	SECONDARY TEACHER	Certificated	T02	05	P	A	1.00	45,793	1.00	42,509
EDN100/AA	7/26/2012	600711	SECONDARY TEACHER	Certificated	T02	05	T	A			1.00	42,509
EDN150/FA	7/26/2012	64346	SPEC ED TEACHER	Certificated	T02	05	T	A	1.00	56,065	1.00	42,509
EDN150/FA	7/26/2012	73680	SPEC ED TEACHER	Certificated	T02	05	P	A	1.00	48,813	1.00	42,509
EDN150/FA	7/26/2012	64805	SPEC ED TEACHER	Certificated	T02	05	T	A	1.00	40,157	1.00	42,509
EDN150/FA	7/26/2012	65101	SPEC ED TEACHER	Certificated	T02	05	P	A	1.00	42,602	1.00	42,509
EDN150/FA	7/26/2012	63222	SPEC ED TEACHER	Certificated	T02	05	P	A	1.00	42,602	1.00	42,509
EDN100/AA	7/26/2012	61379	ELEM TEACHER	Certificated	T02	05	P	A	1.00	46,943	1.00	42,509
EDN150/FA	7/26/2012	62594	GEN EDUC/ARTICLE VI TCHR	Certificated	T02	05	P	A	1.00	46,157	1.00	43,785
EDN100/DB	7/26/2012	71022	ELEM TEACHER	Certificated	T02	05	T	N			1.00	43,785

<u>Prog ID/Org</u>	<u>Separation Date</u>	<u>Position Number</u>	<u>Position Title</u>	<u>Exempt (Y/N)</u>	<u>SR Level</u>	<u>BU Code</u>	<u>T/P</u>	<u>MOF</u>	<u>Budgeted FTE</u>	<u>Budgeted Salary</u>	<u>Actual FTE</u>	<u>Actual Salary</u>
EDN100/AA	7/26/2012	62950	ELEM TEACHER	Certificated	T02	05	P	A	1.00	43,012	1.00	43,785
EDN150/FA	7/26/2012	68270	SPEC ED TEACHER	Certificated	T02	05	P	A	1.00	42,334	1.00	43,785
EDN150/FA	7/26/2012	62415	SPEC ED TEACHER	Certificated	T02	05	P	A	1.00	40,157	1.00	43,785
EDN100/AA	7/26/2012	66295	SECONDARY TEACHER	Certificated	T02	05	P	A	1.00	45,670	1.00	43,785
EDN150/FA	7/26/2012	74843	GEN EDUC/ARTICLE VI TCHR	Certificated	T02	05	P	A	1.00	41,494	1.00	45,098
EDN100/AA	7/26/2012	602258	SPEC ED TEACHER	Certificated	T02	05	T	A			1.00	45,098
EDN150/FA	7/26/2012	76127	GEN EDUC/ARTICLE VI TCHR	Certificated	T02	05	P	A	1.00	43,507	1.00	45,098
EDN100/AA	7/26/2012	63283	SECONDARY TEACHER	Certificated	T02	05	P	A	1.00	43,048	1.00	45,098
EDN100/AA	7/26/2012	61447	ELEM TEACHER	Certificated	T02	05	P	A	1.00	43,048	1.00	45,098
EDN100/AA	7/26/2012	600745	ELEM TEACHER	Certificated	T02	05	T	A			1.00	45,098
EDN150/FA	7/26/2012	73497	SPEC ED TEACHER	Certificated	T02	05	P	A	1.00	42,602	1.00	45,098
EDN100/AA	7/26/2012	69893	SECONDARY TEACHER	Certificated	T02	05	P	A	1.00	43,048	1.00	45,098
EDN150/FA	7/26/2012	72224	SPEC ED TEACHER	Certificated	T02	05	P	A	1.00	42,602	1.00	45,098
EDN150/FA	7/26/2012	75741	GEN EDUC/ARTICLE VI TCHR	Certificated	T02	05	P	A	1.00	43,947	1.00	45,098
EDN150/YC	7/26/2012	58482	BEHAVIORAL HLTH SPCLT IV	N	SR22	13	T	A	1.00	42,066	1.00	45,576
EDN100/AA	7/26/2012	69195	SECONDARY TEACHER	Certificated	T03	05	P	A	1.00	43,157	1.00	45,909
EDN100/AA	7/26/2012	73879	SECONDARY TEACHER	Certificated	T03	05	P	A	1.00	48,351	1.00	45,909
EDN100/AA	7/26/2012	602286	ELEM TEACHER	Certificated	T03	05	T	A			1.00	45,909
EDN150/FA	7/26/2012	73570	SPEC ED TEACHER	Certificated	T03	05	P	A	1.00	49,286	1.00	45,909
EDN100/AA	7/26/2012	601465	ELEM TEACHER	Certificated	T03	05	T	A			1.00	45,909
EDN150/FA	7/26/2012	76057	SPEC ED TEACHER	Certificated	T03	05	P	A	1.00	43,369	1.00	45,909
EDN150/FA	7/26/2012	601825	SPEC ED TEACHER	Certificated	T03	05	T	A			1.00	45,909
EDN150/FA	7/26/2012	602023	SPEC ED TEACHER	Certificated	T03	05	T	A			1.00	45,909
EDN150/FA	7/26/2012	62273	SPEC ED TEACHER	Certificated	T03	05	P	A	1.00	52,728	1.00	45,909
EDN100/AA	7/26/2012	600402	SECONDARY TEACHER	Certificated	T03	05	T	A			1.00	45,909
EDN100/AA	7/26/2012	69178	SECONDARY TEACHER	Certificated	T03	05	P	A	1.00	43,822	1.00	45,909
EDN100/AA	7/26/2012	65138	SECONDARY TEACHER	Certificated	T03	05	P	A	1.00	43,822	1.00	45,909
EDN100/AA	7/26/2012	601697	SECONDARY TEACHER	Certificated	T03	05	T	A			1.00	45,909
EDN100/AA	7/26/2012	602433	ELEM TEACHER	Certificated	T03	05	T	A			1.00	45,909
EDN100/BV	7/26/2012	74849	SECONDARY TEACHER	Certificated	T03	05	T	A	1.00	42,955	1.00	45,909
EDN100/AA	7/26/2012	73184	ELEM TEACHER	Certificated	T03	05	T	A	1.00	45,138	1.00	45,909
EDN150/FA	7/26/2012	72342	SPEC ED TEACHER	Certificated	T03	05	P	A	1.00	46,011	1.00	45,909
EDN100/AA	7/26/2012	68618	SECONDARY TEACHER	Certificated	T03	05	P	A	1.00	38,142	1.00	45,909
EDN100/DB	7/26/2012	601162	SECONDARY TEACHER	Certificated	T03	05	T	N			1.00	45,909
EDN150/NB	7/26/2012	600607	DIST OFF TCHR	Certificated	T03	05	T	N			1.00	45,909
EDN100/AA	7/26/2012	61608	ELEM TEACHER	Certificated	T03	05	P	A	1.00	45,138	1.00	45,909
EDN100/AA	7/26/2012	73597	SECONDARY TEACHER	Certificated	T03	05	T	A	1.00	30,757	1.00	45,909
EDN150/FA	7/26/2012	602292	GEN EDUC/ARTICLE VI TCHR	Certificated	T03	05	T	A			1.00	45,909
EDN100/AA	7/26/2012	602516	ELEM TEACHER	Certificated	T03	05	T	A			1.00	45,909
EDN150/FA	7/26/2012	64388	GEN EDUC/ARTICLE VI TCHR	Certificated	T03	05	P	A	1.00	43,507	1.00	45,909
EDN100/AA	7/26/2012	63327	SPEC ED TEACHER	Certificated	T03	05	P	A			1.00	45,909
EDN150/FA	7/26/2012	66214	SPEC ED TEACHER	Certificated	T03	05	P	A	1.00	43,369	1.00	45,909
EDN100/AA	7/26/2012	72504	SECONDARY TEACHER	Certificated	T03	05	P	A	1.00	47,886	1.00	45,909
EDN100/AA	7/26/2012	600806	SECONDARY TEACHER	Certificated	T03	05	T	A			1.00	45,909
EDN100/DB	7/26/2012	600717	SECONDARY TEACHER	Certificated	T03	05	T	N			1.00	45,909

Department of Education
Personnel Separations

Table 15

<u>Prog ID/Org</u>	<u>Separation Date</u>	<u>Position Number</u>	<u>Position Title</u>	<u>Exempt (Y/N)</u>	<u>SR Level</u>	<u>BU Code</u>	<u>T/P</u>	<u>MOF</u>	<u>Budgeted FTE</u>	<u>Budgeted Salary</u>	<u>Actual FTE</u>	<u>Actual Salary</u>
EDN100/AA	7/26/2012	67561	SECONDARY TEACHER	Certificated	T03	05	P	A	1.00	64,264	1.00	45,909
EDN100/BJ	7/26/2012	73104	SECONDARY TEACHER	Certificated	T03	05	T	A			1.00	45,909
EDN100/AA	7/26/2012	67171	ELEM TEACHER	Certificated	T03	05	P	A	1.00	43,048	1.00	45,909
EDN100/AA	7/26/2012	74264	SECONDARY TEACHER	Certificated	T03	05	T	A	0.50	20,289	1.00	45,909
EDN150/FA	7/26/2012	66674	SPEC ED TEACHER	Certificated	T03	05	T	A	1.00	40,157	1.00	45,909
EDN150/FA	7/26/2012	71707	SPEC ED TCHR/PRE-SCHOOL	Certificated	T03	05	P	A	1.00	43,369	1.00	45,909
EDN100/AA	7/26/2012	63368	ELEM TEACHER	Certificated	T03	05	P	A	1.00	51,793	1.00	45,909
EDN100/AA	7/26/2012	68940	ELEM TEACHER	Certificated	T03	05	P	A	1.00	52,296	1.00	45,909
EDN150/FA	7/26/2012	75501	SPEC ED TEACHER	Certificated	T03	05	T	A	1.00	73,666	1.00	45,909
EDN100/AA	7/26/2012	71118	ELEM TEACHER	Certificated	T03	05	P	A	1.00	46,492	1.00	45,909
EDN100/AA	7/26/2012	72190	ELEM TEACHER	Certificated	T03	05	P	A	1.00	48,351	1.00	45,909
EDN150/FA	7/26/2012	60342	SPEC ED TEACHER	Certificated	T03	05	P	A	1.00	41,362	1.00	45,909
EDN150/FA	7/26/2012	63950	SPEC ED TCHR/PRE-SCHOOL	Certificated	T03	05	P	A	1.00	67,472	1.00	45,909
EDN100/AA	7/26/2012	69147	SECONDARY TEACHER	Certificated	T03	05	P	A	1.00	38,142	1.00	45,909
EDN100/AA	7/26/2012	602250	COUNSELOR	Certificated	T03	05	T	A			1.00	45,909
EDN100/AA	7/26/2012	69389	SECONDARY TEACHER	Certificated	T03	05	T	A	1.00	43,822	1.00	45,909
EDN150/FA	7/26/2012	65735	SPEC ED TEACHER	Certificated	T03	05	P	A	1.00	42,602	1.00	45,909
EDN150/FA	7/26/2012	68720	SPEC ED TEACHER	Certificated	T03	05	P	A	1.00	43,369	1.00	45,909
EDN100/AA	7/26/2012	600446	SECONDARY TEACHER	Certificated	T03	05	T	A			1.00	45,909
EDN100/AA	7/26/2012	66752	SECONDARY TEACHER	Certificated	T03	05	P	A	1.00	43,822	1.00	45,909
EDN150/FA	7/26/2012	602154	GEN EDUC/ARTICLE VI TCHR	Certificated	T03	05	T	A			1.00	45,909
EDN100/AA	7/26/2012	69822	COUNSELOR	Certificated	T03	05	P	A	1.00	46,609	1.00	45,909
EDN150/FA	7/26/2012	75563	SPEC ED TEACHER	Certificated	T03	05	T	A	1.00	43,369	1.00	45,909
EDN100/AA	7/26/2012	67298	SECONDARY TEACHER	Certificated	T03	05	P	A	1.00	43,822	1.00	45,909
EDN150/FA	7/26/2012	602481	SPEC ED TEACHER	Certificated	T03	05	T	A			1.00	45,909
EDN100/AA	7/26/2012	602066	ELEM TEACHER	Certificated	T03	05	P	A			1.00	45,909
EDN100/AA	7/26/2012	60585	ELEM TEACHER	Certificated	T03	05	P	A	1.00	48,351	1.00	45,909
EDN150/FA	7/26/2012	60905	SPEC ED TEACHER	Certificated	T03	05	P	A	1.00	43,369	1.00	45,909
EDN150/FA	7/26/2012	63640	SPEC ED TEACHER	Certificated	T03	05	T	A	1.00	30,439	1.00	45,909
EDN100/AA	7/26/2012	73772	SECONDARY TEACHER	Certificated	T03	05	P	A	1.00	43,822	1.00	45,909
EDN100/AA	7/26/2012	62753	ELEM TEACHER	Certificated	T03	05	P	A	1.00	55,434	1.00	45,909
EDN150/FA	7/26/2012	71762	SPEC ED TEACHER	Certificated	T03	05	P	A			1.00	45,909
EDN150/FA	7/26/2012	73673	SPEC ED TEACHER	Certificated	T03	05	T	A	1.00	41,362	1.00	45,909
EDN100/AA	7/26/2012	74243	SECONDARY TEACHER	Certificated	T03	05	P	A	1.00	30,757	1.00	45,909
EDN100/AA	7/26/2012	60125	ELEM TEACHER	Certificated	T03	05	P	A	1.00	43,822	1.00	45,909
EDN100/AA	7/26/2012	69349	ELEM TEACHER	Certificated	T03	05	T	A	1.00	43,822	1.00	45,909
EDN100/AA	7/26/2012	66456	ELEM TEACHER	Certificated	T03	05	P	A	1.00	47,709	1.00	45,909
EDN150/FA	7/26/2012	66324	SPEC ED TEACHER	Certificated	T03	05	P	A	1.00	37,747	1.00	45,909
EDN100/AA	7/26/2012	62730	ELEM TEACHER	Certificated	T03	05	T	A	1.00	43,822	1.00	45,909
EDN150/FA	7/26/2012	75694	SPEC ED TEACHER	Certificated	T03	05	T	A	1.00	30,439	1.00	45,909
EDN150/FA	7/26/2012	601841	SPEC ED TEACHER	Certificated	T03	05	T	A			1.00	45,909
EDN150/FA	7/26/2012	600062	SPEC ED TEACHER	Certificated	T03	05	T	A			1.00	45,909
EDN150/FA	7/26/2012	65453	GEN EDUC/ARTICLE VI TCHR	Certificated	T03	05	P	A	1.00	73,901	1.00	45,909
EDN100/AA	7/26/2012	62797	ELEM TEACHER	Certificated	T03	05	T	A	1.00	41,559	1.00	45,909
EDN100/AA	7/26/2012	602389	ELEM TEACHER	Certificated	T03	05	T	A			1.00	45,909

Department of Education
Personnel Separations

Table 15

<u>Prog ID/Org</u>	<u>Separation Date</u>	<u>Position Number</u>	<u>Position Title</u>	<u>Exempt (Y/N)</u>	<u>SR Level</u>	<u>BU Code</u>	<u>T/P</u>	<u>MOF</u>	<u>Budgeted FTE</u>	<u>Budgeted Salary</u>	<u>Actual FTE</u>	<u>Actual Salary</u>
EDN100/AA	7/26/2012	68265	ELEM TEACHER	Certificated	T03	05	P	A	1.00	78,098	1.00	45,909
EDN100/AA	7/26/2012	62485	ELEM TEACHER	Certificated	T03	05	P	A	1.00	47,886	1.00	45,909
EDN150/FA	7/26/2012	64317	GEN EDUC/ARTICLE VI TCHR	Certificated	T03	05	P	A	1.00	43,507	1.00	45,909
EDN100/AA	7/26/2012	601633	ELEM TEACHER	Certificated	T03	05	T	A			1.00	45,909
EDN100/AA	7/26/2012	62938	ELEM TEACHER	Certificated	T03	05	P	A	1.00	55,434	1.00	45,909
EDN150/NB	7/26/2012	79501	DIST OFF TCHR	Certificated	T03	05	T	N			1.00	45,909
EDN150/FA	7/26/2012	75848	SPEC ED TEACHER	Certificated	T03	05	T	A	1.00	40,157	1.00	45,909
EDN100/AA	7/26/2012	66631	SECONDARY TEACHER	Certificated	T03	05	P	A	1.00	57,098	1.00	45,909
EDN100/AA	7/26/2012	64611	SECONDARY TEACHER	Certificated	T03	05	P	A	1.00	43,048	1.00	45,909
EDN150/FA	7/26/2012	72410	SPEC ED TEACHER	Certificated	T03	05	P	A	1.00	55,833	1.00	45,909
EDN150/FA	7/26/2012	74376	SPEC ED TEACHER	Certificated	T03	05	P	A	1.00	61,781	1.00	45,909
EDN150/FA	7/26/2012	601044	SPEC ED TCHR/PRE-SCHOOL	Certificated	T03	05	P	A			1.00	45,909
EDN150/FA	7/26/2012	71161	SPEC ED TEACHER	Certificated	T03	05	P	A	1.00	46,011	1.00	45,909
EDN150/FA	7/26/2012	68805	GEN EDUC/ARTICLE VI TCHR	Certificated	T03	05	P	A	1.00	43,507	1.00	45,909
EDN100/AA	7/26/2012	63238	ELEM TEACHER	Certificated	T03	05	T	A	1.00	51,426	1.00	45,909
EDN150/FA	7/26/2012	60077	SPEC ED TEACHER	Certificated	T03	05	P	A	1.00	44,671	1.00	45,909
EDN150/FA	7/26/2012	64512	SPEC ED TEACHER	Certificated	T03	05	T	A	1.00	37,747	1.00	45,909
EDN100/AA	7/26/2012	67708	ELEM TEACHER	Certificated	T03	05	P	A	1.00	40,577	1.00	45,909
EDN100/AA	7/26/2012	72105	SECONDARY TEACHER	Certificated	T03	05	P	A	1.00	43,822	1.00	45,909
EDN100/AA	7/26/2012	65911	ELEM TEACHER	Certificated	T03	05	P	A	1.00	40,577	1.00	45,909
EDN150/FA	7/26/2012	74327	SPEC ED TEACHER	Certificated	T03	05	P	A	1.00	43,369	1.00	45,909
EDN100/AA	7/26/2012	69595	ELEM TEACHER	Certificated	T03	05	P	A	1.00	63,374	1.00	45,909
EDN150/FA	7/26/2012	66134	SPEC ED TEACHER	Certificated	T03	05	T	A	1.00	43,369	1.00	45,909
EDN150/FA	7/26/2012	65480	SPEC ED TEACHER	Certificated	T03	05	P	A	1.00	66,711	1.00	45,909
EDN100/AA	7/26/2012	67203	ELEM TEACHER	Certificated	T03	05	P	A	1.00	44,265	1.00	45,909
EDN100/AA	7/26/2012	60578	SECONDARY TEACHER	Certificated	T03	05	P	A	1.00	53,866	1.00	45,909
EDN150/FA	7/26/2012	73121	SPEC ED TCHR/PRE-SCHOOL	Certificated	T03	05	P	A	1.00	56,507	1.00	45,909
EDN100/AA	7/26/2012	600037	SECONDARY TEACHER	Certificated	T03	05	T	A			1.00	45,909
EDN100/AA	7/26/2012	602268	ELEM TEACHER	Certificated	T03	05	T	A			1.00	45,909
EDN150/FA	7/26/2012	601305	SPEC ED TEACHER	Certificated	T03	05	T	A			1.00	45,909
EDN100/DB	7/26/2012	79413	ELEM TEACHER	Certificated	T03	05	T	N			1.00	45,909
EDN150/FA	7/26/2012	600989	SPEC ED TEACHER	Certificated	T03	05	T	A			1.00	45,909
EDN100/AA	7/26/2012	64793	SECONDARY TEACHER	Certificated	T03	05	P	A	1.00	59,466	1.00	45,909
EDN100/AA	7/26/2012	601570	ELEM TEACHER	Certificated	T03	05	T	A			1.00	45,909
EDN100/AA	7/26/2012	65959	ELEM TEACHER	Certificated	T03	05	P	A	1.00	67,521	1.00	45,909
EDN150/FA	7/26/2012	68235	SPEC ED TEACHER	Certificated	T03	05	P	A	1.00	37,747	1.00	45,909
EDN100/AA	7/26/2012	601732	SECONDARY TEACHER	Certificated	T03	05	T	A			1.00	45,909
EDN150/FA	7/26/2012	73685	SPEC ED TEACHER	Certificated	T03	05	T	A	1.00	40,157	1.00	45,909
EDN100/AA	7/26/2012	602404	ELEM TEACHER	Certificated	T03	05	T	A			1.00	45,909
EDN100/AA	7/26/2012	65305	COUNSELOR	Certificated	T03	05	P	A	1.00	46,609	1.00	45,909
EDN150/FA	7/26/2012	64805	SPEC ED TEACHER	Certificated	T03	05	T	A	1.00	40,157	1.00	45,909
EDN100/AA	7/26/2012	73374	COUNSELOR	Certificated	T03	05	P	A	1.00	53,483	1.00	45,909
EDN100/AA	7/26/2012	71778	SECONDARY TEACHER	Certificated	T03	05	T	A	1.00	46,492	1.00	45,909
EDN100/AA	7/26/2012	62693	COUNSELOR	Certificated	T03	05	P	A	1.00	58,959	1.00	45,909
EDN100/AA	7/26/2012	65771	COUNSELOR	Certificated	T03	05	P	A	1.00	43,157	1.00	45,909

Department of Education
Personnel Separations

Table 15

<u>Prog ID/Org</u>	<u>Separation Date</u>	<u>Position Number</u>	<u>Position Title</u>	<u>Exempt (Y/N)</u>	<u>SR Level</u>	<u>BU Code</u>	<u>T/P</u>	<u>MOF</u>	<u>Budgeted FTE</u>	<u>Budgeted Salary</u>	<u>Actual FTE</u>	<u>Actual Salary</u>
EDN100/AA	7/26/2012	65788	SECONDARY TEACHER	Certificated	T03	05	P	A	1.00	50,285	1.00	45,909
EDN150/FA	7/26/2012	602044	SPEC ED TEACHER	Certificated	T03	05	T	A			1.00	45,909
EDN100/AA	7/26/2012	600822	ELEM TEACHER	Certificated	T03	05	T	A			1.00	45,909
EDN150/FA	7/26/2012	68473	SPEC ED TEACHER	Certificated	T03	05	P	A	1.00	43,369	1.00	45,909
EDN100/AA	7/26/2012	601637	ELEM TEACHER	Certificated	T03	05	T	A			1.00	45,909
EDN150/FA	7/26/2012	74335	SPEC ED TEACHER	Certificated	T03	05	P	A	1.00	37,747	1.00	45,909
EDN150/FA	7/26/2012	73335	SPEC ED TEACHER	Certificated	T03	05	P	A	1.00	40,157	1.00	45,909
EDN100/AA	7/26/2012	75010	COUNSELOR/HIGH RISK	Certificated	T03	05	P	A	1.00	55,622	1.00	45,909
EDN100/AA	7/26/2012	68079	ELEM TEACHER	Certificated	T03	05	P	A	1.00	51,296	1.00	45,909
EDN100/AA	7/26/2012	67905	COUNSELOR	Certificated	T03	05	P	A	1.00	60,729	1.00	45,909
EDN100/AA	7/26/2012	72676	LIBRARIAN	Certificated	T03	05	P	A	1.00	58,035	1.00	45,909
EDN150/FA	7/26/2012	63401	SPEC ED TEACHER	Certificated	T03	05	P	A	1.00	37,747	1.00	45,909
EDN150/FA	7/26/2012	61728	SPEC ED TCHR/PRE-SCHOOL	Certificated	T03	05	P	A	1.00	30,439	1.00	45,909
EDN100/AA	7/26/2012	601723	ELEM TEACHER	Certificated	T03	05	T	A			1.00	45,909
EDN100/AA	7/26/2012	601892	SPEC ED TEACHER	Certificated	T03	05	T	A			1.00	45,909
EDN100/AA	7/26/2012	62892	ELEM TEACHER	Certificated	T02	05	P	A	1.00	44,339	1.00	46,451
EDN100/AA	7/26/2012	73151	COUNSELOR	Certificated	T03	05	P	A	1.00	48,008	1.00	47,287
EDN100/AA	7/26/2012	69771	SECONDARY TEACHER	Certificated	T03	05	P	A	1.00	46,120	1.00	47,287
EDN100/DB	7/26/2012	602328	SECONDARY TEACHER	Certificated	T03	05	T	N			1.00	47,287
EDN150/FA	7/26/2012	600437	SPEC ED TEACHER	Certificated	T03	05	T	A			1.00	47,287
EDN150/FB	7/26/2012	60268	SPECIAL SCH TEACHER	Certificated	T03	05	P	A	1.00	44,268	1.00	47,287
EDN100/AA	7/26/2012	601441	ELEM TEACHER	Certificated	T03	05	T	A			1.00	47,287
EDN100/AA	7/26/2012	63017	SECONDARY TEACHER	Certificated	T03	05	P	A	1.00	49,448	1.00	47,287
EDN100/AA	7/26/2012	71922	SECONDARY TEACHER	Certificated	T03	05	T	A	1.00	45,138	1.00	47,287
EDN100/AA	7/26/2012	63603	ELEM TEACHER	Certificated	T03	05	P	A	1.00	43,822	1.00	47,287
EDN100/AA	7/26/2012	602441	SECONDARY TEACHER	Certificated	T03	05	T	A			1.00	47,287
EDN100/AA	7/26/2012	600135	ELEM TEACHER	Certificated	T03	05	T	A			1.00	47,287
EDN100/AA	7/26/2012	600447	COUNSELOR	Certificated	T03	05	T	A			1.00	47,287
EDN100/AA	7/26/2012	69603	SECONDARY TEACHER	Certificated	T03	05	P	A	1.00	58,081	1.00	47,287
EDN100/BB	7/26/2012	65814	SECONDARY TEACHER	Certificated	T03	05	P	A	1.00	45,178	1.00	47,287
EDN150/FA	7/26/2012	75266	SPEC ED TEACHER	Certificated	T03	05	P	A	1.00	49,765	1.00	47,287
EDN100/AA	7/26/2012	71642	SECONDARY TEACHER	Certificated	T03	05	P	A	1.00	45,138	1.00	47,287
EDN100/AA	7/26/2012	62340	SECONDARY TEACHER	Certificated	T03	05	P	A	1.00	45,138	1.00	47,287
EDN150/FA	7/26/2012	61083	GEN EDUC/ARTICLE VI TCHR	Certificated	T03	05	P	A	1.00	41,494	1.00	47,287
EDN150/FA	7/26/2012	73269	SPEC ED TEACHER	Certificated	T03	05	P	A	1.00	46,011	1.00	47,287
EDN100/AA	7/26/2012	72285	SECONDARY TEACHER	Certificated	T03	05	P	A	1.00	45,138	1.00	47,287
EDN100/AA	7/26/2012	61937	SECONDARY TEACHER	Certificated	T03	05	P	A	1.00	53,348	1.00	47,287
EDN150/FA	7/26/2012	72174	SPEC ED TEACHER	Certificated	T03	05	P	A	1.00	44,671	1.00	47,287
EDN100/AA	7/26/2012	71960	SECONDARY TEACHER	Certificated	T03	05	T	A	1.00	48,008	1.00	47,287
EDN100/AA	7/26/2012	600944	ELEM TEACHER	Certificated	T03	05	T	A			1.00	47,287
EDN100/AA	7/26/2012	61765	ELEM TEACHER	Certificated	T03	05	T	A	1.00	49,904	1.00	47,287
EDN100/AA	7/26/2012	74121	ELEM TEACHER	Certificated	T03	05	P	A	1.00	44,805	1.00	47,287
EDN150/FA	7/26/2012	68196	SPEC ED TEACHER	Certificated	T03	05	P	A	1.00	44,671	1.00	47,287
EDN150/FA	7/26/2012	67167	SPEC ED TCHR/PRE-SCHOOL	Certificated	T03	05	P	A	1.00	43,369	1.00	47,287
EDN100/AA	7/26/2012	60731	SECONDARY TEACHER	Certificated	T03	05	P	A	1.00	46,492	1.00	47,287

<u>Prog ID/Org</u>	<u>Separation Date</u>	<u>Position Number</u>	<u>Position Title</u>	<u>Exempt (Y/N)</u>	<u>SR Level</u>	<u>BU Code</u>	<u>T/P</u>	<u>MOF</u>	<u>Budgeted FTE</u>	<u>Budgeted Salary</u>	<u>Actual FTE</u>	<u>Actual Salary</u>
EDN100/AA	7/26/2012	65075	SECONDARY TEACHER	Certificated	T03	05	P	A	1.00	54,330	1.00	47,287
EDN100/AA	7/26/2012	67680	SECONDARY TEACHER	Certificated	T03	05	P	A	1.00	53,348	1.00	47,287
EDN150/FA	7/26/2012	71327	SPEC ED TEACHER	Certificated	T03	05	P	A	1.00	54,860	1.00	47,287
EDN100/AA	7/26/2012	68882	COUNSELOR	Certificated	T03	05	P	A	1.00	49,448	1.00	47,287
EDN150/FA	7/26/2012	65081	SPEC ED TEACHER	Certificated	T03	05	P	A	1.00	44,671	1.00	47,287
EDN100/AA	7/26/2012	75334	COUNSELOR/HIGH RISK	Certificated	T04	05	T	A	1.00	53,483	1.00	47,746
EDN150/FA	7/26/2012	73321	SPEC ED TEACHER	Certificated	T04	05	P	A	1.00	40,157	1.00	47,746
EDN100/AA	7/26/2012	68689	SECONDARY TEACHER	Certificated	T04	05	T	A	1.00	38,142	1.00	47,746
EDN100/AA	7/26/2012	71714	SECONDARY TEACHER	Certificated	T04	05	T	A	1.00	45,576	1.00	47,746
EDN100/AA	7/26/2012	69839	SECONDARY TEACHER	Certificated	T02	05	P	A	1.00	41,794	1.00	47,845
EDN100/AA	7/26/2012	66194	SECONDARY TEACHER	Certificated	T03	05	P	A	1.00	46,492	1.00	48,706
EDN100/AA	7/26/2012	61166	COUNSELOR	Certificated	T03	05	P	A	1.00	49,448	1.00	48,706
EDN100/AA	7/26/2012	71137	ELEM TEACHER	Certificated	T03	05	P	A	1.00	46,492	1.00	48,706
EDN100/AA	7/26/2012	66124	ELEM TEACHER	Certificated	T03	05	P	A	1.00	46,492	1.00	48,706
EDN100/AA	7/26/2012	75152	ELEM TEACHER	Certificated	T03	05	T	A	1.00	46,492	1.00	48,706
EDN150/FA	7/26/2012	63071	SPEC ED TEACHER	Certificated	T03	05	P	A	1.00	41,494	1.00	48,706
EDN150/FA	7/26/2012	68341	GEN EDUC/ARTICLE VI TCHR	Certificated	T03	05	P	A	1.00	47,366	1.00	48,706
EDN150/FA	7/26/2012	65744	SPEC ED TEACHER	Certificated	T03	05	P	A	1.00	46,011	1.00	48,706
EDN150/FA	7/26/2012	75702	GEN EDUC/ARTICLE VI TCHR	Certificated	T03	05	P	A	1.00	46,157	1.00	48,706
EDN100/AA	7/26/2012	61887	ELEM TEACHER	Certificated	T03	05	P	A	1.00	46,492	1.00	48,706
EDN100/AA	7/26/2012	68118	ELEM TEACHER	Certificated	T03	05	P	A	1.00	43,048	1.00	48,706
EDN100/AA	7/26/2012	73153	COUNSELOR	Certificated	T03	05	P	A	1.00	49,448	1.00	48,706
EDN100/AA	7/26/2012	71811	SECONDARY TEACHER	Certificated	T03	05	P	A	1.00	64,264	1.00	48,706
EDN100/AA	7/26/2012	62197	ELEM TEACHER	Certificated	T04	05	T	A	1.00	41,794	1.00	49,179
EDN150/FA	7/26/2012	75895	GEN EDUC/ARTICLE VI TCHR	Certificated	T04	05	P	A	1.00	46,605	1.00	49,179
EDN100/AA	7/26/2012	68325	SECONDARY TEACHER	Certificated	T05	05	P	A	1.00	43,822	1.00	49,655
EDN100/BO	7/26/2012	71312	SECONDARY TEACHER	Certificated	T03	05	T	A			1.00	50,167
EDN100/AA	7/26/2012	69102	ELEM TEACHER	Certificated	T03	05	P	A	1.00	47,886	1.00	50,167
EDN100/AA	7/26/2012	62485	ELEM TEACHER	Certificated	T03	05	P	A	1.00	47,886	1.00	50,167
EDN150/FA	7/26/2012	65671	GEN EDUC/ARTICLE VI TCHR	Certificated	T03	05	P	A	1.00	44,813	1.00	50,167
EDN150/NB	7/26/2012	79374	DIST OFF TCHR	Certificated	T04	05	T	N			1.00	50,654
EDN100/AA	7/26/2012	74109	ELEM TEACHER	Certificated	T04	05	P	A	1.00	48,351	1.00	50,654
EDN100/AA	7/26/2012	64277	ELEM TEACHER	Certificated	T04	05	P	A	1.00	48,351	1.00	50,654
EDN100/AA	7/26/2012	72651	SECONDARY TEACHER	Certificated	T04	05	P	A	1.00	46,492	1.00	50,654
EDN100/AA	7/26/2012	67738	COUNSELOR	Certificated	T04	05	T	A	1.00	51,426	1.00	50,654
EDN150/FA	7/26/2012	71338	SPEC ED TEACHER	Certificated	T04	05	P	A	1.00	47,851	1.00	50,654
EDN150/FA	7/26/2012	69436	SPEC ED TEACHER	Certificated	T04	05	P	A	1.00	48,003	1.00	50,654
EDN100/AA	7/26/2012	68151	ELEM TEACHER	Certificated	T04	05	P	A	1.00	48,351	1.00	50,654
EDN100/AA	7/26/2012	61082	ELEM TEACHER	Certificated	T04	05	P	A	1.00	40,577	1.00	50,654
EDN100/AA	7/26/2012	60585	ELEM TEACHER	Certificated	T04	05	P	A	1.00	48,351	1.00	50,654
EDN100/AA	7/26/2012	72218	ELEM TEACHER	Certificated	T04	05	T	A	1.00	46,492	1.00	50,654
EDN100/AA	7/26/2012	68642	ELEM TEACHER	Certificated	T02	05	P	A	1.00	48,451	1.00	50,759
EDN150/FA	7/26/2012	73796	SPEC ED TCHR/PRE-SCHOOL	Certificated	T05	05	P	A	1.00	54,860	1.00	51,146
EDN100/AA	7/26/2012	72106	SECONDARY TEACHER	Certificated	T06	05	P	A	1.00	43,822	1.00	51,642
EDN100/AA	7/26/2012	60813	ELEM TEACHER	Certificated	T03	05	P	A	1.00	49,323	1.00	51,673

Department of Education
Personnel Separations

Table 15

<u>Prog ID/Org</u>	<u>Separation Date</u>	<u>Position Number</u>	<u>Position Title</u>	<u>Exempt (Y/N)</u>	<u>SR Level</u>	<u>BU Code</u>	<u>T/P</u>	<u>MOF</u>	<u>Budgeted FTE</u>	<u>Budgeted Salary</u>	<u>Actual FTE</u>	<u>Actual Salary</u>
EDN100/AA	7/26/2012	68538	ELEM TEACHER	Certificated	T04	05	P	A	1.00	49,801	1.00	52,173
EDN150/FA	7/26/2012	76122	GEN EDUC/ARTICLE VI TCHR	Certificated	T04	05	P	A	1.00	49,443	1.00	52,173
EDN100/BB	7/26/2012	63065	SECONDARY TEACHER	Certificated	T05	05	P	A	1.00	50,221	1.00	52,680
EDN100/AA	7/26/2012	62598	SECONDARY TEACHER	Certificated	T05	05	P	A	1.00	47,886	1.00	52,680
EDN150/FA	7/26/2012	76051	SPEC ED TEACHER	Certificated	T05	05	P	A	1.00	47,216	1.00	52,680
EDN100/AA	7/26/2012	66926	ELEM TEACHER	Certificated	T05	05	P	A	1.00	50,285	1.00	52,680
EDN100/AA	7/26/2012	60429	ELEM TEACHER	Certificated	T05	05	P	A	1.00	50,285	1.00	52,680
EDN150/FA	7/26/2012	60481	SPEC ED TEACHER	Certificated	T05	05	P	A	1.00	49,765	1.00	52,680
EDN150/FA	7/26/2012	71797	SPEC ED TEACHER	Certificated	T05	05	P	A	1.00	49,765	1.00	52,680
EDN100/AA	7/26/2012	62405	ELEM TEACHER	Certificated	T05	05	P	A	1.00	51,268	1.00	52,680
EDN100/AA	7/26/2012	68788	SECONDARY TEACHER	Certificated	T05	05	P	A	1.00	50,285	1.00	52,680
EDN100/AA	7/26/2012	71231	ELEM TEACHER	Certificated	T04	05	P	A	1.00	51,296	1.00	53,739
EDN150/FA	7/26/2012	63682	GEN EDUC/ARTICLE VI TCHR	Certificated	T04	05	P	A	1.00	50,927	1.00	53,739
EDN100/DB	7/26/2012	79535	SECONDARY TEACHER	Certificated	T05	05	T	N			1.00	54,260
EDN100/AA	7/26/2012	63479	ELEM TEACHER	Certificated	T06	05	P	A	1.00	74,436	1.00	54,787
EDN100/AA	7/26/2012	66770	SECONDARY TEACHER	Certificated	T06	05	P	A	1.00	52,296	1.00	54,787
EDN100/AA	7/26/2012	65283X	SECONDARY TEACHER	Certificated	T06	05	T	A	1.00	55,622	1.00	54,787
EDN100/AA	7/26/2012	65680	SECONDARY TEACHER	Certificated	T06	05	P	A	1.00	57,098	1.00	54,787
EDN100/AA	7/26/2012	68827	SECONDARY TEACHER	Certificated	T06	05	P	A	1.00	47,886	1.00	54,787
EDN100/AA	7/26/2012	68909	ELEM TEACHER	Certificated	T04	05	P	A	1.00	52,835	1.00	55,352
EDN150/FA	7/26/2012	65377	SPEC ED TCHR/PRE-SCHOOL	Certificated	T05	05	P	A	1.00	52,796	1.00	55,888
EDN100/AA	7/26/2012	63484	ELEM TEACHER	Certificated	T06	05	P	A	0.50	26,933	1.00	56,431
EDN100/AA	7/26/2012	66173	SECONDARY TEACHER	Certificated	T07	05	P	A	1.00	40,577	1.00	58,074
EDN100/AA	7/26/2012	74251	ELEM TEACHER	Certificated	T07	05	T	A	1.00	52,296	1.00	58,074
EDN100/AA	7/26/2012	60206	ELEM TEACHER	Certificated	T07	05	P	A	1.00	44,265	1.00	58,074
EDN100/AA	7/26/2012	74871	ELEM TEACHER	Certificated	T07	05	P	A	1.00	53,514	1.00	58,074
EDN100/BV	7/26/2012	74252	SECONDARY TEACHER	Certificated	T07	05	T	A	1.00	54,337	1.00	58,074
EDN100/AA	7/26/2012	63109	SECONDARY TEACHER	Certificated	T07	05	P	A	1.00	55,434	1.00	58,074
EDN150/FA	7/26/2012	73915	SPEC ED TEACHER	Certificated	T07	05	P	A	1.00	41,362	1.00	58,074
EDN100/AA	7/26/2012	600397	ELEM TEACHER	Certificated	T07	05	T	A			1.00	58,074
EDN100/AA	7/26/2012	74247	SECONDARY TEACHER	Certificated	T06	05	P	A	1.00	55,482	1.00	58,124
EDN150/FA	7/26/2012	75753	GEN EDUC/ARTICLE VI TCHR	Certificated	T07	05	T	A	1.00	56,687	1.00	59,818
EDN100/AA	7/26/2012	66045	ELEM TEACHER	Certificated	T07	05	P	A	1.00	46,492	1.00	59,818
EDN100/AA	7/26/2012	63298	ELEM TEACHER	Certificated	T07	05	T	A	1.00	52,471	1.00	59,818
EDN100/AA	7/26/2012	72712	ELEM TEACHER	Certificated	T07	05	P	A	1.00	57,098	1.00	59,818
EDN100/AA	7/26/2012	62152	ELEM TEACHER	Certificated	T07	05	P	A	1.00	57,098	1.00	59,818
EDN100/AA	7/26/2012	62943	ELEM TEACHER	Certificated	T07	05	P	A	1.00	57,098	1.00	59,818
EDN100/AA	7/26/2012	66896	ELEM TEACHER	Certificated	T07	05	P	A	1.00	58,810	1.00	61,611
EDN150/FA	7/26/2012	68282	ELEM TEACHER	Certificated	T06	05	P	A	1.00	60,627	1.00	63,514
EDN150/FA	7/26/2012	67128	SPEC ED TEACHER	Certificated	T07	05	P	A	1.00	61,746	1.00	65,363
EDN400/MD	7/27/2012	42812	CAFETERIA HELPER	N	BC02	01	T	B			0.50	16,614
EDN150/YG	7/27/2012	801528	EDUC ASST III	Y	SR12	03	T	A			1.00	25,030
EDN150/YC	7/27/2012	58084	HUMAN SVCS PROF IV	N	SR22	13	P	A	1.00	42,066	1.00	45,576
EDN150/FA	7/27/2012	61004	SPEC ED TEACHER	Certificated	T03	05	P	A			1.00	48,706
EDN100/AA	7/28/2012	800717	OFFICE ASSISTANT III	N	SR08	03	T	A			1.00	13,327

Prog ID/Org	Separation Date	Position Number	Position Title	Exempt (Y/N)	SR Level	BU Code	T/P	MOF	Budgeted FTE	Budgeted Salary	Actual FTE	Actual Salary
EDN400/MD	7/28/2012	59917	CAFETERIA HELPER	N	BC02	01	T	B			0.50	16,614
EDN150/FA	7/28/2012	55735	EDUC ASST III	Y	SR12	03	P	A	0.75	20,495	0.75	21,097
EDN100/AA	7/28/2012	61555	ELEM TEACHER	Certificated	T02	05	T	A	1.00	55,434	1.00	37,893
EDN100/AA	7/28/2012	64301	SECONDARY TEACHER	Certificated	T04	05	P	A	1.00	43,822	1.00	57,835
EDN100/AA	7/28/2012	602511	VICE PRINCIPAL II	Certificated	E03	06	T	A			1.00	65,362
EDN100/AA	7/28/2012	75203	VICE PRINCIPAL III	Certificated	E05	06	P	A	1.00	75,569	1.00	70,066
EDN100/AA	7/28/2012	71436	VICE PRINCIPAL I	Certificated	E03	06	T	A	1.00	75,569	1.00	70,066
EDN100/CB	7/31/2012	59996	OFFICE ASSISTANT III	N	SR08	03	T	A	1.00	23,666	1.00	25,668
EDN150/FA	8/1/2012	802569	EDUC ASST III	Y	SR12	03	P	A			0.50	14,065
EDN200/GN	8/1/2012	29998	BILINGUAL/BICULTURAL S/H ASST	Y	SR11	03	T	A	1.00	35,862	0.50	14,418
EDN150/FA	8/1/2012	58941	EDUC ASST III	Y	SR12	03	P	A	0.50	14,193	0.50	14,610
EDN400/MD	8/1/2012	42853	CAFETERIA HELPER	N	BC02	01	T	B			0.50	16,614
EDN400/MD	8/1/2012	801918	CAFETERIA HELPER	N	BC02	01	T	B			0.50	16,614
EDN100/AA	8/1/2012	29330	SCHOOL HEALTH AIDE	N	SR09	03	P	A	1.00	17,401	1.00	18,078
EDN150/FA	8/1/2012	58062	EDUC ASST III	Y	SR12	03	P	A	0.75	20,495	0.75	21,097
EDN150/YG	8/1/2012	801836	EDUC ASST II	Y	SR10	03	T	A			1.00	27,756
EDN150/FA	8/1/2012	43852	EDUC ASST III	Y	SR12	03	P	A	0.87	27,965	0.88	28,787
EDN150/FA	8/1/2012	57062	EDUC ASST III	Y	SR12	03	P	A	1.00	28,385	1.00	29,220
EDN100/AA	8/1/2012	37539	EDUC ASST III	Y	SR12	03	P	A	1.00	31,769	1.00	30,430
EDN400/MD	8/1/2012	9232	CAFETERIA HELPER	N	BC02	01	P	B	1.00	10,385	1.00	33,228
EDN100/AA	8/1/2012	65743	LIBRARIAN	Certificated	T05	05	T	A	0.50	33,067	0.50	33,366
EDN100/AA	8/1/2012	38951	OFFICE ASSISTANT II	N	SR06	03	P	A	1.00	30,036	1.00	33,756
EDN400/OC	8/1/2012	10127	SECRETARY IV	N	SR18	03	P	W			1.00	37,968
EDN100/AA	8/1/2012	16509	SCHOOL CUSTODIAN IV	N	F102	02	P	A	1.00	38,160	1.00	38,160
EDN150/SA	8/1/2012	30709	SCH BASED OCC THRPY ASST (FP)	N	HE10	10	P	A	1.00	41,613	1.00	45,108
EDN400/OC	8/1/2012	59831	SECRETARY II	N	SR14	03	P	A	1.00	28,281	1.00	46,176
EDN150/YC	8/1/2012	58364	BEHAVIORAL HLTH SPCLT IV	N	SR22	13	T	A	1.00	43,761	1.00	47,412
EDN400/MD	8/1/2012	2072	SCHOOL FOOD SERVICES MGR III	N	F206	02	P	A	1.00	39,336	1.00	48,096
EDN150/FA	8/1/2012	74383	SPEC ED TEACHER	Certificated	T03	05	P	A	1.00	46,011	1.00	48,706
EDN400/MD	8/1/2012	9819	SCHOOL FOOD SERVICES MGR III	N	F206	02	P	A	1.00	40,925	1.00	50,040
EDN400/MD	8/1/2012	1971	SCHOOL FOOD SERVICES MGR III	N	F206	02	P	B			1.00	50,040
EDN150/FA	8/1/2012	75942	GEN EDUC/ARTICLE VI TCHR	Certificated	T03	05	P	A	1.00	47,541	1.00	50,167
EDN100/AA	8/1/2012	69443	ELEM TEACHER	Certificated	T03	05	P	A	1.00	49,323	1.00	51,673
EDN100/DB	8/1/2012	601988	12-MO STATE OFF TCHR	Certificated	T05	05	T	N			1.00	52,680
EDN150/YC	8/1/2012	58359	BEHAVIORAL SPECIALIST IV	N	SR22	13	P	A	1.00	49,243	1.00	53,352
EDN100/AA	8/1/2012	601471	SECONDARY TEACHER	Certificated	T06	05	T	A			1.00	54,787
EDN150/YC	8/1/2012	58347	BEHAVIORAL HLTH SPCLT IV	N	SR22	13	P	A	1.00	51,226	1.00	55,500
EDN100/AA	8/1/2012	71317	ELEM TEACHER	Certificated	T05	05	P	A	1.00	56,740	1.00	55,888
EDN100/AA	8/1/2012	68773	SECONDARY TEACHER	Certificated	T07	05	P	A	1.00	31,679	1.00	56,384
EDN150/YC	8/1/2012	58497	BEHAVIORAL HLTH SPCLT IV	N	SR22	13	P	A	1.00	53,264	1.00	57,708
EDN150/YC	8/1/2012	58516	BEHAVIORAL SPECIALIST IV	N	SR22	13	P	A	1.00	53,264	1.00	57,708
EDN100/AA	8/1/2012	601918	ELEM TEACHER	Certificated	T07	05	T	A			1.00	58,074
EDN100/AA	8/1/2012	65906	SECONDARY TEACHER	Certificated	T03	05	P	A	1.00	55,513	1.00	58,157
EDN100/AA	8/1/2012	74312	SECONDARY TEACHER	Certificated	T06	05	P	A	1.00	59,617	1.00	63,514
EDN150/SA	8/1/2012	30441	SPEECH PATHOLOGIST IV	Y	SR22	13	P	A	1.00	63,874	1.00	64,920

Department of Education
Personnel Separations

Table 15

Prog ID/Org	Separation Date	Position Number	Position Title	Exempt (Y/N)	SR Level	BU Code	T/P	MOF	Budgeted FTE	Budgeted Salary	Actual FTE	Actual Salary
EDN150/FA	8/1/2012	73471	SPEC ED TEACHER	Certificated	T07	05	P	A	1.00	54,939	1.00	65,363
EDN150/FA	8/1/2012	60325	SPEC ED TCHR/PRE-SCHOOL	Certificated	T06	05	P	A	1.00	61,799	1.00	65,419
EDN100/AA	8/1/2012	66226	ELEM TEACHER	Certificated	T07	05	P	A	1.00	64,264	1.00	67,325
EDN100/AA	8/1/2012	601576	ELEM TEACHER	Certificated	T07	05	T	A			1.00	67,325
EDN100/AA	8/1/2012	62165	SECONDARY TEACHER	Certificated	T07	05	P	A	1.00	64,264	1.00	67,325
EDN100/AA	8/1/2012	66963	ELEM TEACHER	Certificated	T07	05	P	A	1.00	65,247	1.00	67,325
EDN100/AA	8/1/2012	63704	ELEM TEACHER	Certificated	T07	05	T	A	1.00	64,264	1.00	67,325
EDN100/AA	8/1/2012	69489	ELEM TEACHER	Certificated	T07	05	P	A	1.00	66,191	1.00	69,344
EDN100/AA	8/1/2012	72316	SECONDARY TEACHER	Certificated	T07	05	P	A	1.00	66,191	1.00	69,344
EDN100/AA	8/1/2012	66137	ELEM TEACHER	Certificated	T04	05	P	A	1.00	61,405	1.00	71,129
EDN100/AA	8/1/2012	66343	ELEM TEACHER	Certificated	T07	05	P	A	1.00	68,177	1.00	71,425
EDN100/BB	8/1/2012	64425	SECONDARY TEACHER	Certificated	T07	05	P	A	1.00	67,748	1.00	71,425
EDN100/AA	8/1/2012	66232	ELEM TEACHER	Certificated	T07	05	T	A	1.00	43,822	1.00	72,455
EDN100/AA	8/1/2012	74475	SECONDARY TEACHER	Certificated	T07	05	P	A	1.00	75,419	1.00	77,982
EDN100/AA	8/1/2012	67602	COUNSELOR	Certificated	T07	05	P	A	1.00	79,170	1.00	77,982
EDN100/AA	8/1/2012	71202	SECONDARY TEACHER	Certificated	T07	05	P	A	1.00	60,627	1.00	77,982
EDN100/AA	8/1/2012	68873	ELEM TEACHER	Certificated	T07	05	P	A	1.00	75,419	1.00	77,982
EDN150/YG	8/1/2012	75732	DISTRICT EDUC SPEC II	Certificated	E07	06	P	A	1.00	78,373	1.00	84,947
EDN400/OC	8/1/2012	17077	ENGINEER VI	N	SR28	13	P	A	1.00	81,119	1.00	88,848
EDN100/AA	8/1/2012	64361	12-MO ELEM PRIN I	Certificated	E05	06	P	A	1.00	93,136	1.00	93,136
EDN200/GC	8/1/2012	60033	EDUCATIONAL SPEC II	Certificated	E07	06	P	A	1.00	83,849	1.00	93,626
EDN100/AA	8/2/2012	56456	OFFICE ASSISTANT III	N	SR08	03	P	A	0.50	12,834	0.50	12,834
EDN150/FA	8/2/2012	47592	EDUC ASST III	Y	SR12	03	P	A	1.00	28,385	1.00	29,220
EDN100/AA	8/2/2012	67438	ELEM TEACHER	Certificated	T03	05	P	A	1.00	46,492	1.00	48,706
EDN100/AA	8/3/2012	64009	ELEM TEACHER	Certificated	T02	05	P	A	1.00	55,482	1.00	42,509
EDN150/FA	8/4/2012	57340	EDUC ASST III	Y	SR12	03	T	A	0.75	18,237	0.75	18,773
EDN150/FA	8/4/2012	57287	EDUC ASST III	Y	SR12	03	T	A	0.75	20,495	0.75	21,097
EDN100/AA	8/4/2012	802224	DP USER SUPPORT TECH I	N	SR13	03	T	A			1.00	31,212
EDN100/AA	8/4/2012	66106	12-MO SECONDARY TEACHER	Certificated	T02	05	P	A	1.00	53,420	1.00	45,098
EDN150/YC	8/4/2012	58746	BEHAVIORAL HLTH SPCLT IV	N	SR22	13	P	A	1.00	42,066	1.00	45,576
EDN100/AA	8/4/2012	600319	ELEM TEACHER	Certificated	T03	05	T	A			1.00	45,909
EDN100/AA	8/4/2012	69390	SECONDARY TEACHER	Certificated	T03	05	P	A	1.00	43,822	1.00	45,909
EDN100/AA	8/7/2012	601291	10-MO STUDENT SVCS COORD	Certificated	T03	05	T	A			0.50	22,955
EDN400/MB	8/8/2012	801555	ACCOUNTANT III	N	SR20	13	T	N			1.00	42,132
EDN150/FA	8/8/2012	66937	SPEC ED TCHR/PRE-SCHOOL	Certificated	T03	05	P	A	1.00	41,362	1.00	53,990
EDN150/NB	8/8/2012	79311	EDUCATIONAL SPEC II	Certificated	E07	06	T	N	1.00	80,350	1.00	80,350
EDN150/FA	8/9/2012	601716	SPEC ED TEACHER	Certificated	T03	05	T	A			1.00	45,909
EDN100/AA	8/9/2012	73191	ELEM TEACHER	Certificated	T04	05	T	A	1.00	49,569	1.00	50,654
EDN150/FA	8/9/2012	69920	SPEC ED TEACHER	Certificated	T07	05	P	A	1.00	70,701	1.00	58,074
EDN150/FA	8/10/2012	58964	EDUC ASST II	Y	SR10	03	P	A	0.75	18,237	0.75	17,348
EDN150/YG	8/10/2012	59559	BEHAVIORAL HLTH SPCLT III	N	SR20	13	P	A	1.00	42,049	1.00	42,132
EDN150/FA	8/10/2012	69324	GEN EDUC/ARTICLE VI TCHR	Certificated	T03	05	P	A	1.00	40,285	1.00	48,706
EDN150/FA	8/11/2012	802363	EDUC ASST III	Y	SR12	03	P	A			0.50	12,515
EDN150/FA	8/11/2012	57217	EDUC ASST I	Y	SR08	03	T	A	0.75	18,237	0.75	16,043
EDN150/YG	8/11/2012	800826	EDUC ASST II	Y	SR10	03	P	A	1.00	25,053	1.00	24,030

Department of Education
Personnel Separations

Table 15

Prog ID/Org	Separation Date	Position Number	Position Title	Exempt (Y/N)	SR Level	BU Code	T/P	MOF	Budgeted FTE	Budgeted Salary	Actual FTE	Actual Salary
EDN150/FA	8/11/2012	64930	SPEC ED TEACHER	Certificated	T03	05	P	A	1.00	30,439	1.00	45,909
EDN150/FA	8/11/2012	602067	GEN EDUC/ARTICLE VI TCHR	Certificated	T03	05	T	A			1.00	45,909
EDN150/FA	8/11/2012	601617	SPEC ED TEACHER	Certificated	T03	05	T	A			1.00	45,909
EDN150/YC	8/11/2012	58491	BEHAVIORAL HLTH SPCLT IV	N	SR22	13	T	A	1.00	42,066	1.00	47,412
EDN150/FA	8/11/2012	75926	GEN EDUC/ARTICLE VI TCHR	Certificated	T03	05	P	A	1.00	46,157	1.00	48,706
EDN150/FA	8/14/2012	71630	SPEC ED TEACHER	Certificated	T03	05	P	A			1.00	53,990
EDN150/FA	8/15/2012	58783	EDUC ASST II	Y	SR10	03	P	A	1.00	24,314	1.00	23,130
EDN150/SA	8/15/2012	30935	COMMUNICATION AIDE	Y	SR12	03	P	A	1.00	26,024	1.00	25,030
EDN100/AA	8/15/2012	9914	SCHOOL ADM SERVICES ASST II	Certificated	SR14	04	P	A	1.00	36,516	1.00	36,516
EDN150/FA	8/16/2012	57030	EDUC ASST III	Y	SR12	03	T	A			0.75	18,773
EDN300/KO	8/16/2012	12176	PERSONNEL CLERK IV	N	SR11	03	P	A	1.00	30,193	1.00	33,756
EDN100/DB	8/16/2012	600716	SECONDARY TEACHER	Certificated	T05	05	T	N			1.00	52,680
EDN300/KD	8/16/2012	15713	AUDITOR V	N	SR24	13	P	A	1.00	46,131	1.00	57,708
EDN150/YG	8/17/2012	801871	EDUC ASST III	Y	SR12	03	T	A			1.00	25,030
EDN150/NB	8/17/2012	800361	EDUC ASST III	Y	SR12	03	T	N			1.00	27,020
EDN400/MB	8/17/2012	59553	ACCOUNTANT IV	N	SR22	13	T	N	1.00	45,576	1.00	51,312
EDN100/AA	8/17/2012	64946	ELEM TEACHER	Certificated	T02	05	P	A	1.00	43,048	1.00	53,036
EDN150/FA	8/18/2012	601255	SPEC ED TEACHER	Certificated	T03	05	T	A			1.00	45,909
EDN150/FA	8/18/2012	60967	SPEC ED TEACHER	Certificated	T03	05	P	A	1.00	46,011	1.00	48,706
EDN100/BJ	8/18/2012	69878	VICE PRINCIPAL III	Certificated	E05	06	P	A	1.00	69,707	1.00	69,097
EDN100/AA	8/18/2012	602876	10-MONTH SAC TEACHER	Certificated	T07	05	T	A			1.00	79,175
EDN150/NB	8/21/2012	32303	SECRETARY II	N	SR14	03	T	N	1.00	33,756	1.00	32,424
EDN100/AA	8/21/2012	71736	ELEM TEACHER	Certificated	T03	05	P	A	1.00	46,492	1.00	45,909
EDN100/AA	8/22/2012	603035	COUNSELOR	Certificated	T03	05	T	A			1.00	57,279
EDN300/KF	8/23/2012	35480	PRE AUDIT CLERK II	N	SR13	03	P	A	1.00	35,479	1.00	39,480
EDN150/FA	8/23/2012	74419	SPEC ED TEACHER	Certificated	T03	05	P	A	1.00	48,813	1.00	60,768
EDN150/FA	8/23/2012	63281	SPEC ED TEACHER	Certificated	T06	05	P	A	1.00	51,755	1.00	64,430
EDN100/AA	8/25/2012	55850	EDUC ASST II	Y	SR10	03	P	A	0.50	13,066	0.50	11,565
EDN150/FA	8/25/2012	43959	EDUC ASST II	Y	SR10	03	P	A	1.00	24,314	1.00	21,970
EDN150/FA	8/25/2012	802346	EDUC ASST III	Y	SR12	03	T	A			1.00	25,030
EDN150/SA	8/25/2012	30465	COMMUNICATION AIDE	Y	SR12	03	P	A	1.00	27,093	1.00	28,130
EDN150/FA	8/28/2012	55341	EDUC ASST II	Y	SR10	03	P	A	0.50	13,663	0.50	13,005
EDN100/AA	8/28/2012	800677	GEN PROF IV	N	SR22	13	T	A	1.00	52,182	1.00	55,500
EDN100/AA	8/29/2012	36596	SCHOOL HEALTH AIDE	N	SR09	03	P	A	1.00	18,793	1.00	19,524
EDN150/FA	8/29/2012	67382	SPEC ED TEACHER	Certificated	T03	05	P	A	1.00	73,666	1.00	45,909
EDN100/AA	8/29/2012	75806	SECONDARY TEACHER	Certificated	T02	05	T	A	1.00	44,339	1.00	46,451
EDN150/FA	8/31/2012	52942	EDUC ASST II	Y	SR10	03	P	A	0.75	18,237	0.75	17,348
EDN400/MD	9/1/2012	9511	CAFETERIA HELPER	N	BC02	01	P	B	1.00	10,385	0.50	16,614
EDN100/AA	9/1/2012	31267	SCHOOL CUSTODIAN II	N	BC02	01	P	A	0.50	16,614	0.50	16,614
EDN400/MD	9/1/2012	9413	CAFETERIA HELPER	N	BC02	01	P	B	0.50	5,192	0.50	16,614
EDN400/MD	9/1/2012	9882	CAFETERIA HELPER	N	BC02	01	T	B			0.50	16,614
EDN100/AA	9/1/2012	29496	SCHOOL HEALTH AIDE	N	SR09	03	P	A	1.00	26,747	1.00	18,078
EDN150/FA	9/1/2012	56716	EDUC ASST III	Y	SR12	03	P	A	0.75	20,495	0.75	21,097
EDN100/AA	9/1/2012	29300	SCHOOL HEALTH AIDE	N	SR09	03	P	A	1.00	26,747	1.00	27,787
EDN150/FA	9/1/2012	55201	EDUC ASST III	Y	SR12	03	P	A	1.00	27,326	1.00	28,130

<u>Prog ID/Org</u>	<u>Separation Date</u>	<u>Position Number</u>	<u>Position Title</u>	<u>Exempt (Y/N)</u>	<u>SR Level</u>	<u>BU Code</u>	<u>T/P</u>	<u>MOF</u>	<u>Budgeted FTE</u>	<u>Budgeted Salary</u>	<u>Actual FTE</u>	<u>Actual Salary</u>
EDN150/FA	9/1/2012	55388	EDUC ASST III	Y	SR12	03	P	A	1.00	27,326	1.00	28,130
EDN150/YG	9/1/2012	801837	EDUC ASST III	Y	SR12	03	T	A			1.00	30,036
EDN100/AA	9/1/2012	16660	SCHOOL CUSTODIAN II	N	BC02	01	P	A	1.00	33,228	1.00	33,228
EDN100/AA	9/1/2012	21878	SCHOOL CUSTODIAN II	N	BC02	01	P	A	1.00	33,228	1.00	33,228
EDN400/OC	9/1/2012	17198	GENERAL LABORER II	N	BC03	01	P	A	1.00	30,682	1.00	34,164
EDN200/GN	9/1/2012	58098	OFFICE ASSISTANT III	N	SR08	03	P	A	1.00	31,851	1.00	35,064
EDN100/AA	9/1/2012	1847	SCHOOL ADM SERVICES ASST II	Certificated	SR14	04	P	A	1.00	39,480	1.00	39,480
EDN100/AA	9/1/2012	601427	SECONDARY TEACHER	Certificated	T03	05	T	A			1.00	45,909
EDN400/OC	9/1/2012	17151	PLUMBER II	N	WS10	01	P	A	1.00	46,740	1.00	48,960
EDN150/YC	9/1/2012	800440	SCHOOL PSYCHOLOGIST	Y	SR24	13	P	A	1.00	54,194	1.00	51,312
EDN150/YC	9/1/2012	31503	SCHOOL PSYCHOLOGIST	Y	SR24	13	P	A	1.00	54,194	1.00	51,312
EDN150/YG	9/1/2012	76107	DIST OFF TCHR	Certificated	T05	05	T	A			1.00	54,260
EDN150/YC	9/1/2012	58289	CLINICAL PSYCHOLOGIST VI	N	SR26	13	P	A	1.00	60,939	1.00	55,500
EDN100/AA	9/1/2012	69023	ELEM TEACHER	Certificated	T06	05	P	A	1.00	59,010	1.00	58,124
EDN100/AA	9/1/2012	65835	ELEM TEACHER	Certificated	T07	05	T	A	1.00	47,474	1.00	59,818
EDN100/AA	9/1/2012	67186	SECONDARY TEACHER	Certificated	T06	05	P	A	1.00	60,627	1.00	63,514
EDN200/GN	9/1/2012	76195	COMPLEX AREA TEACHER	Certificated	T07	05	T	A	1.00	62,087	1.00	67,325
EDN100/BJ	9/1/2012	65942	SECONDARY TEACHER	Certificated	T07	05	T	A			1.00	73,567
EDN100/AA	9/1/2012	66573	ELEM TEACHER	Certificated	T07	05	P	A	1.00	70,222	1.00	73,567
EDN150/FA	9/1/2012	66774	GEN EDUC/ARTICLE VI TCHR	Certificated	T07	05	P	A	1.00	74,876	1.00	77,982
EDN200/GN	9/1/2012	60083	COMPLX SCH RENEW SPEC II	Certificated	E07	06	P	A	1.00	89,910	1.00	98,980
EDN200/GB	9/1/2012	67118	ASST SUPT,CURR/INST	N	E00	06	P	A	1.00	103,124	1.00	115,000
EDN100/AA	9/4/2012	39008	OFFICE ASSISTANT III	N	SR08	03	P	A	1.00	33,756	1.00	25,668
EDN100/AA	9/4/2012	75806	SECONDARY TEACHER	Certificated	T02	05	T	A	1.00	44,339	1.00	32,222
EDN100/AA	9/4/2012	66056	SECONDARY TEACHER	Certificated	T03	05	T	A	1.00	44,030	1.00	48,706
EDN400/MD	9/5/2012	54661	CAFETERIA HELPER	N	BC02	01	T	B	0.50	5,192	0.50	16,614
EDN100/AA	9/5/2012	68344	ELEM TEACHER	Certificated	T02	05	P	A	1.00	41,794	1.00	49,991
EDN200/GC	9/5/2012	60054	VOC/TECH EDUC SPEC II	Certificated	E07	06	P	A	1.00	96,355	1.00	107,591
EDN150/FA	9/6/2012	52653	EDUC ASST III	Y	SR12	03	P	A	1.00	30,736	1.00	31,640
EDN150/YC	9/6/2012	800432	SCHOOL PSYCHOLOGIST	Y	SR24	13	P	A	1.00	62,235	1.00	60,024
EDN150/FA	9/7/2012	52612	EDUC ASST III	Y	SR12	03	P	A	0.50	12,633	0.50	13,005
EDN150/FA	9/8/2012	800492	EDUC ASST III	Y	SR12	03	P	A	1.00	24,314	1.00	25,030
EDN150/YG	9/8/2012	801795	EDUC ASST III	Y	SR12	03	T	A			1.00	30,036
EDN100/AA	9/8/2012	45218	SCHOOL CUSTODIAN II	N	BC02	01	P	A	1.00	33,228	1.00	33,228
EDN100/AA	9/8/2012	69655	ELEM TEACHER	Certificated	T02	05	P	A	1.00	60,028	1.00	45,098
EDN150/FA	9/8/2012	603366	GEN EDUC/ARTICLE VI TCHR	Certificated	T03	05	T	A			1.00	45,909
EDN150/YC	9/8/2012	58519	BEHAVIORAL HLTH SPCLT IV	N	SR22	13	P	A	1.00	42,066	1.00	47,412
EDN100/AA	9/8/2012	72332	VICE PRINCIPAL II	Certificated	E04	06	P	A	1.00	74,523	1.00	66,273
EDN400/OC	9/11/2012	43544	BUILDING MAINTENANCE WORKER I	N	BC09	01	P	A	1.00	40,004	1.00	23,134
EDN100/AA	9/11/2012	62254	12-MO ELEM PRIN IV	Certificated	E08	06	P	A	1.00	137,459	1.00	137,459
EDN100/AA	9/12/2012	68910	ELEM TEACHER	Certificated	T02	05	T	A	1.00	40,577	1.00	42,509
EDN150/FB	9/13/2012	61236	SPECIAL SCH TEACHER	Certificated	T03	05	P	A	1.00	46,559	1.00	57,279
EDN400/MD	9/15/2012	55712	CAFETERIA HELPER	N	BC02	01	T	B	0.50	5,192	0.50	16,614
EDN150/FA	9/15/2012	37501	EDUC ASST III	Y	SR12	03	P	A	1.00	25,266	1.00	26,010
EDN100/AA	9/15/2012	602687	SECONDARY TEACHER	Certificated	T02	05	T	A			1.00	32,222

Prog ID/Org	Separation Date	Position Number	Position Title	Exempt (Y/N)	SR Level	BU Code	T/P	MOF	Budgeted FTE	Budgeted Salary	Actual FTE	Actual Salary
EDN150/YC	9/15/2012	58078	HUMAN SVCS PROF II	N	SR18	13	P	A	1.00	42,066	1.00	38,988
EDN150/FA	9/15/2012	62287	SPEC ED TEACHER	Certificated	T02	05	P	A	1.00	49,056	1.00	43,785
EDN100/AA	9/15/2012	68898	SECONDARY TEACHER	Certificated	T03	05	P	A	1.00	45,138	1.00	45,909
EDN100/AA	9/15/2012	64175	SECONDARY TEACHER	Certificated	T05	05	P	A	1.00	45,138	1.00	51,146
EDN150/YC	9/15/2012	58745	CLINICAL PSYCHOLOGIST VI	N	SR26	13	P	A	1.00	61,748	1.00	55,500
EDN100/AA	9/18/2012	802166	OFFICE ASSISTANT III	N	SR08	03	T	A			0.50	12,834
EDN150/FA	9/18/2012	60204	GEN EDUC/ARTICLE VI TCHR	Certificated	T02	05	P	A	1.00	63,802	1.00	42,509
EDN100/AA	9/18/2012	71247	ELEM TEACHER	Certificated	T03	05	P	A	1.00	70,222	1.00	45,909
EDN150/YC	9/20/2012	801826	BEHAVIORAL HLTH SPCLT III	N	SR20	13	P	A			1.00	42,132
EDN150/FA	9/20/2012	602976	SPEC ED TCHR/PRE-SCHOOL	Certificated	T02	05	T	A			1.00	42,509
EDN150/FA	9/20/2012	71992	SPEC ED TEACHER	Certificated	T02	05	P	A	1.00	40,157	1.00	42,509
EDN300/UA	9/20/2012	42580	AUTOMATED SYSTS EQUIP TECH I	N	BC14	01	P	A	1.00	47,704	1.00	53,532
EDN100/AA	9/20/2012	63647	ELEM TEACHER	Certificated	T07	05	P	A	1.00	66,191	1.00	69,344
EDN100/DB	9/22/2012	802052	ACCOUNT CLERK II	N	SR08	03	T	N			0.50	12,834
EDN100/AA	9/22/2012	16110	SCHOOL CUSTODIAN II	N	BC02	01	P	A	0.50	16,614	0.50	16,614
EDN150/YG	9/22/2012	801831	EDUC ASST III	Y	SR12	03	T	A			1.00	30,036
EDN100/AA	9/22/2012	16426	SCHOOL CUSTODIAN II	N	BC02	01	P	A	1.00	33,228	1.00	33,228
EDN100/DB	9/22/2012	79857	TITLE I LINKER TEACHER	Certificated	T03	05	T	N			1.00	45,909
EDN100/BS	9/22/2012	73414	ROTC INSTRUCTOR	Certificated	ROTC	05	T	A	1.00	79,667	1.00	83,882
EDN100/AA	9/26/2012	56514	OFFICE ASSISTANT III	N	SR08	03	P	A	0.50	14,418	0.50	12,834
EDN300/KF	9/27/2012	37315	PRE AUDIT CLERK II	N	SR13	03	P	A	1.00	30,335	1.00	31,212
EDN150/FB	9/28/2012	57889	EDUC ASST III	Y	SR12	03	P	A	1.00	24,095	1.00	25,030
EDN150/FB	9/28/2012	72899F	SPEC ED TEACHER	Certificated	T03	05	P	A	1.00	39,795	1.00	55,611
EDN150/FA	9/28/2012	67917	GEN EDUC/ARTICLE VI TCHR	Certificated	T07	05	P	A	1.00	59,363	1.00	61,611
EDN100/AA	9/29/2012	801300	OFFICE ASSISTANT III	N	SR08	03	P	A	0.50	12,834	0.50	12,834
EDN400/MD	9/29/2012	11207	CAFETERIA HELPER	N	BC02	01	P	B	0.50	5,192	0.50	16,614
EDN400/MD	9/29/2012	26846	CAFETERIA HELPER	N	BC02	01	P	B	0.50	5,192	0.50	16,614
EDN400/MD	9/29/2012	41865	CAFETERIA HELPER	N	BC02	01	T	B	0.50	5,192	0.50	16,614
EDN400/OD	9/29/2012	37392	SCHOOL CUSTODIAN II	N	BC02	01	P	A	0.50	14,922	0.50	16,614
EDN400/MD	9/29/2012	59680	CAFETERIA HELPER	N	BC02	01	T	B			0.50	16,614
EDN100/AA	9/29/2012	802205	EDUC ASST III	Y	SR12	03	T	A			0.88	21,901
EDN100/DB	9/29/2012	59798	PERSONNEL CLERK III	N	SR09	03	T	N			1.00	27,756
EDN150/FA	9/29/2012	52549	EDUC ASST III	Y	SR12	03	P	A	1.00	29,561	1.00	30,430
EDN100/AA	9/29/2012	16339	SCHOOL CUSTODIAN II	N	BC02	01	P	A	1.00	33,228	1.00	33,228
EDN400/MD	9/29/2012	50894	CAFETERIA HELPER	N	BC02	01	P	B	1.00	10,385	1.00	33,228
EDN100/AA	9/29/2012	18583	SCHOOL CUSTODIAN II	N	BC02	01	P	A	1.00	36,072	1.00	33,228
EDN400/OC	9/29/2012	25213	TRACTOR OPERATOR	N	BC04	01	P	A	1.00	31,922	1.00	35,544
EDN300/KO	9/29/2012	58576	PERSONNEL CLERK V	N	SR13	03	P	A	1.00	33,961	1.00	37,968
EDN400/MD	9/29/2012	21271	SCHOOL COOK II	N	BC06	01	P	B	1.00	12,012	1.00	38,436
EDN100/AA	9/29/2012	14681	OFFICE ASSISTANT III	N	SR08	03	P	A	1.00	27,756	1.00	39,480
EDN100/AA	9/29/2012	61218	ELEM TEACHER	Certificated	T02	05	P	A	1.00	45,138	1.00	42,509
EDN150/FA	9/29/2012	72565	SPEC ED TEACHER	Certificated	T03	05	P	A	1.00	48,595	1.00	45,909
EDN100/AA	9/29/2012	63479	ELEM TEACHER	Certificated	T03	05	P	A	1.00	74,436	1.00	45,909
EDN100/AA	9/29/2012	63690	ELEM TEACHER	Certificated	T03	05	P	A	1.00	46,492	1.00	48,706
EDN400/MD	9/29/2012	12531	SCHOOL FOOD SERVICES MGR III	N	F206	02	P	B			1.00	50,040

Department of Education
Personnel Separations

Table 15

<u>Prog ID/Org</u>	<u>Separation Date</u>	<u>Position Number</u>	<u>Position Title</u>	<u>Exempt (Y/N)</u>	<u>SR Level</u>	<u>BU Code</u>	<u>T/P</u>	<u>MOF</u>	<u>Budgeted FTE</u>	<u>Budgeted Salary</u>	<u>Actual FTE</u>	<u>Actual Salary</u>
EDN100/AA	9/29/2012	63715X	ELEM TEACHER	Certificated	T07	05	T	A	1.00	57,197	1.00	58,074
EDN100/AA	9/29/2012	62576	COUNSELOR	Certificated	T06	05	P	A	1.00	66,416	1.00	65,419
EDN150/FA	10/1/2012	29641	EDUC ASST III	Y	SR12	03	P	A	1.00	33,223	1.00	34,200
EDN100/AA	10/1/2012	600368	COUNSELOR	Certificated	T05	05	T	A			1.00	52,680
EDN150/FA	10/1/2012	71171	GEN EDUC/ARTICLE VI TCHR	Certificated	T05	05	P	A	1.00	52,964	1.00	55,888
EDN100/AA	10/1/2012	73058	ELEM TEACHER	Certificated	T06	05	T	A	1.00	53,866	1.00	56,431
EDN100/BB	10/1/2012	65595	SECONDARY TEACHER	Certificated	T07	05	P	A	1.00	55,932	1.00	59,818
EDN150/FA	10/1/2012	67861	SPEC ED TEACHER	Certificated	T07	05	P	A	1.00	58,202	1.00	61,611
EDN100/AA	10/1/2012	72743	SECONDARY TEACHER	Certificated	T07	05	P	A	1.00	60,575	1.00	63,460
EDN100/AA	10/1/2012	71549	ELEM TEACHER	Certificated	T07	05	P	A	1.00	64,264	1.00	67,325
EDN100/AA	10/1/2012	71700	SECONDARY TEACHER	Certificated	T07	05	P	A	1.00	68,177	1.00	71,425
EDN100/AA	10/1/2012	63022	SECONDARY TEACHER	Certificated	T07	05	P	A	1.00	68,177	1.00	71,425
EDN100/AA	10/1/2012	71854	12-MONTH REGISTRAR	Certificated	T07	05	P	A	1.00	89,626	1.00	73,567
EDN100/AA	10/1/2012	63350	ELEM TEACHER	Certificated	T07	05	P	A	1.00	74,436	1.00	77,982
EDN200/GN	10/1/2012	601086	COMPLEX AREA PERSONNEL SPECIALIST II	Certificated	E07	06	T	A			1.00	98,980
EDN200/GM	10/1/2012	60031	ADV TECH EDUC SPEC II	Certificated	E07	06	P	A	1.00	95,541	1.00	106,105
EDN300/KO	10/1/2012	60100	PERS REGIONAL OFFICER II	Certificated	E07	06	P	A	1.00	97,584	1.00	109,099
EDN200/GN	10/1/2012	600470	COMPLX SCH RENEW SPEC II	Certificated	E07	06	T	A			1.00	143,317
EDN100/DB	10/3/2012	600775	SECONDARY TEACHER	Certificated	T05	05	T	N			1.00	52,680
EDN150/FA	10/6/2012	53134	EDUC ASST III	Y	SR12	03	P	A	0.75	18,237	0.75	18,773
EDN150/SA	10/6/2012	30469	COMMUNICATION AIDE	Y	SR12	03	P	A	1.00	27,093	1.00	28,130
EDN100/AA	10/6/2012	14701	OFFICE ASSISTANT III	N	SR08	03	P	A	1.00	33,756	1.00	33,756
EDN150/FA	10/6/2012	74145	SPEC ED TEACHER	Certificated	T03	05	P	A	1.00	42,602	1.00	45,909
EDN150/SA	10/6/2012	800422	SCHOOL PSYCHOLOGIST	Y	SR24	13	P	A	1.00	62,235	1.00	60,024
EDN150/YG	10/9/2012	801876	EDUC ASST II	Y	SR10	03	T	A			1.00	23,130
EDN100/AA	10/9/2012	53180	OFFICE ASSISTANT III	N	SR08	03	P	A	1.00	25,668	1.00	25,668
EDN150/FA	10/9/2012	74426	SPEC ED TEACHER	Certificated	T03	05	P	A	1.00	41,362	1.00	45,909
EDN100/AA	10/10/2012	71784	ELEM TEACHER	Certificated	T02	05	T	A	1.00	41,794	1.00	42,509
EDN100/AA	10/10/2012	600435	ELEM TEACHER	Certificated	T05	05	T	A			1.00	52,680
EDN100/AA	10/11/2012	29473	SCHOOL HEALTH AIDE	N	SR09	03	P	A	1.00	17,401	1.00	18,078
EDN150/FA	10/11/2012	603558	GEN EDUC/ARTICLE VI TCHR	Certificated	T05	05	T	A			1.00	52,680
EDN100/DB	10/13/2012	802482	DISTRICT PCNC ASSISTANT	N	SR15	03	T	N			0.50	8,764
EDN150/FA	10/13/2012	800277	EDUC ASST II	Y	SR10	03	P	A	0.50	13,663	0.50	13,005
EDN150/FA	10/13/2012	57264	EDUC ASST III	Y	SR12	03	T	A	0.75	18,237	0.75	18,773
EDN100/AA	10/13/2012	72712	ELEM TEACHER	Certificated	T02	05	P	A	1.00	57,098	1.00	32,222
EDN150/FA	10/13/2012	21623	EDUC ASST III	Y	SR12	03	P	A	1.00	30,736	1.00	32,900
EDN150/FA	10/13/2012	63042	SPEC ED TEACHER	Certificated	T03	05	T	A	1.00	40,157	1.00	45,909
EDN150/FA	10/13/2012	73643	SPEC ED TEACHER	Certificated	T04	05	P	A	1.00	47,851	1.00	50,654
EDN100/AA	10/13/2012	64078	SECONDARY TEACHER	Certificated	T03	05	P	A	1.00	45,138	1.00	53,990
EDN150/FA	10/16/2012	56133	EDUC ASST III	Y	SR12	03	P	A	0.75	18,237	0.75	18,773
EDN150/YG	10/16/2012	800261	EDUC ASST III	Y	SR12	03	P	A	1.00	24,109	1.00	25,030
EDN200/GN	10/16/2012	58095	OFFICE ASSISTANT III	N	SR08	03	P	A	1.00	25,213	1.00	27,756
EDN100/AA	10/17/2012	66856	ELEM TEACHER	Certificated	T02	05	P	A	1.00	57,098	1.00	42,509
EDN100/BJ	10/18/2012	73044	SPECIAL SCH TEACHER	Certificated	T03	05	P	A	1.00	44,133	1.00	47,287
EDN150/YC	10/18/2012	32092	SCHOOL PSYCHOLOGIST	Y	SR24	13	P	A	1.00	54,194	1.00	51,312

<u>Prog ID/Org</u>	<u>Separation Date</u>	<u>Position Number</u>	<u>Position Title</u>	<u>Exempt (Y/N)</u>	<u>SR Level</u>	<u>BU Code</u>	<u>T/P</u>	<u>MOF</u>	<u>Budgeted FTE</u>	<u>Budgeted Salary</u>	<u>Actual FTE</u>	<u>Actual Salary</u>
EDN150/FA	10/19/2012	24889	EDUC ASST II	Y	SR10	03	P	A	1.00	24,314	1.00	23,130
EDN150/FA	10/20/2012	57493	EDUC ASST III	Y	SR12	03	T	A	0.75	18,237	0.75	18,773
EDN150/FA	10/20/2012	57498	EDUC ASST III	Y	SR12	03	T	A	0.75	18,950	0.75	19,508
EDN150/FA	10/20/2012	57495	EDUC ASST III	Y	SR12	03	T	A	0.75	18,950	0.75	19,508
EDN150/YG	10/20/2012	801737	EDUC ASST III	Y	SR12	03	T	A			1.00	25,030
EDN100/AA	10/20/2012	55868	EDUC ASST III	Y	SR12	03	T	A	1.00	30,506	1.00	29,220
EDN150/FA	10/20/2012	65279	GEN EDUC/ARTICLE VI TCHR	Certificated	T03	05	P	A	1.00	42,738	1.00	47,287
EDN150/FA	10/20/2012	68736	SPEC ED TEACHER	Certificated	T03	05	P	A			1.00	55,611
EDN400/OC	10/20/2012	17077	ENGINEER VI	N	SR28	13	P	A	1.00	81,119	1.00	62,424
EDN200/GN	10/23/2012	58053	OFFICE ASSISTANT III	N	SR08	03	P	A	1.00	24,253	1.00	26,700
EDN100/AA	10/24/2012	54907	SCHOOL CUSTODIAN II	N	BC02	01	P	A	1.00	33,228	1.00	33,228
EDN150/FA	10/24/2012	75722	SPEC ED TEACHER	Certificated	T02	05	T	A	1.00	40,157	1.00	49,991
EDN150/YG	10/26/2012	800824	EDUC ASST III	Y	SR12	03	P	A	1.00	25,053	1.00	26,010
EDN400/MB	10/27/2012	801150	OFFICE ASSISTANT III	N	SR08	03	T	N	1.00	25,668	1.00	13,327
EDN150/YG	10/27/2012	801855	EDUC ASST III	Y	SR12	03	T	A			1.00	25,030
EDN100/AA	10/27/2012	19093	SCHOOL CUSTODIAN II	N	BC02	01	P	A	1.00	33,228	1.00	33,228
EDN100/AA	10/27/2012	65652	SECONDARY TEACHER	Certificated	T02	05	P	A	1.00	50,285	1.00	42,509
EDN100/BM	10/27/2012	52462	ATHLETIC HLTH CARE TRAINER	Y	SR22	13	P	A	1.00	42,073	1.00	45,576
EDN150/FA	10/27/2012	64394	GEN EDUC/ARTICLE VI TCHR	Certificated	T03	05	P	A	1.00	40,285	1.00	45,909
EDN100/AA	10/30/2012	600859	ELEM TEACHER	Certificated	T02	05	T	A			1.00	42,509
EDN100/AA	10/31/2012	33122	SCHOOL SECURITY ATTENDANT	N	SR07	03	P	A	1.00	24,148	1.00	22,250
EDN100/AA	11/1/2012	800345	EDUC ASST II	Y	SR10	03	P	A	0.50	15,885	0.50	14,065
EDN100/AA	11/1/2012	26413	SCHOOL CUSTODIAN II	N	BC02	01	P	A	0.50	16,614	0.50	16,614
EDN400/MD	11/1/2012	55387	CAFETERIA HELPER	N	BC02	01	T	B	0.50	5,192	0.50	16,614
EDN150/YG	11/1/2012	801880	EDUC ASST III	Y	SR12	03	T	A			1.00	25,030
EDN150/SA	11/1/2012	56231	SOCIAL WORKER IV	N	SR22	13	P	A	0.50	24,337	0.50	25,656
EDN400/OC	11/1/2012	44200	POWER MOWER OPERATOR I	N	BC03	01	P	A	1.00	30,682	1.00	34,164
EDN150/FA	11/1/2012	54451	EDUC ASST III	Y	SR12	03	P	A	1.00	33,223	1.00	34,200
EDN400/MD	11/1/2012	11408	SCHOOL COOK I	N	BC04	01	P	B	1.00	11,108	1.00	35,544
EDN400/MD	11/1/2012	10112	SCHOOL COOK II	N	BC06	01	P	B	1.00	12,012	1.00	38,436
EDN150/FA	11/1/2012	60992	SPEC ED TEACHER	Certificated	T03	05	P	A	1.00	43,369	1.00	45,909
EDN150/FA	11/1/2012	60278	SPEC ED TEACHER	Certificated	T03	05	P	A	1.00	46,011	1.00	48,706
EDN400/OC	11/1/2012	17111	MASON II	N	WS10	01	P	A	1.00	43,970	1.00	48,960
EDN150/YC	11/1/2012	58448	BEHAVIORAL HLTH SPCLT IV	N	SR22	13	P	A	1.00	51,226	1.00	55,500
EDN150/FA	11/1/2012	61242	SPEC ED TEACHER	Certificated	T07	05	P	A	1.00	54,860	1.00	58,074
EDN100/AA	11/1/2012	600430	ELEM TEACHER	Certificated	T07	05	T	A			1.00	63,460
EDN100/AA	11/1/2012	72298	ELEM TEACHER	Certificated	T07	05	P	A	1.00	65,247	1.00	67,325
EDN100/AA	11/1/2012	66102	ELEM TEACHER	Certificated	T05	05	P	A	1.00	67,521	1.00	70,737
EDN200/GD	11/1/2012	60273	STATE OFFICE TEACHER	Certificated	T07	05	P	A	1.00	66,916	1.00	71,425
EDN200/GG	11/1/2012	69973	SCH LIBRARY SVCS SPEC II	Certificated	E07	06	P	A	1.00	72,181	1.00	80,350
EDN100/AA	11/2/2012	58587	EDUC ASST III	Y	SR12	03	P	A	1.00	27,612	1.00	30,430
EDN100/AA	11/3/2012	16409	SCHOOL CUSTODIAN II	N	BC02	01	P	A	0.50	16,614	0.50	16,614
EDN150/FA	11/3/2012	76154	SPEC ED TEACHER	Certificated	T02	05	P	A	1.00	40,157	1.00	32,222
EDN100/AA	11/3/2012	63139	SECONDARY TEACHER	Certificated	T03	05	P	A	1.00	54,565	1.00	34,799
EDN100/AA	11/3/2012	60884	ELEM TEACHER	Certificated	T02	05	P	A	1.00	56,416	1.00	42,509

<u>Prog ID/Org</u>	<u>Separation Date</u>	<u>Position Number</u>	<u>Position Title</u>	<u>Exempt (Y/N)</u>	<u>SR Level</u>	<u>BU Code</u>	<u>T/P</u>	<u>MOF</u>	<u>Budgeted FTE</u>	<u>Budgeted Salary</u>	<u>Actual FTE</u>	<u>Actual Salary</u>
EDN150/FA	11/3/2012	602718	GEN EDUC/ARTICLE VI TCHR	Certificated	T02	05	T	A			1.00	42,509
EDN400/OC	11/6/2012	34313	ENGINEER V	N	SR26	13	P	A	1.00	63,026	1.00	28,814
EDN100/AA	11/7/2012	16636	SCHOOL CUSTODIAN II	N	BC02	01	P	A	0.50	16,614	0.50	16,614
EDN100/AA	11/8/2012	30629	SCHOOL SECURITY ATTENDANT	N	SR07	03	P	A	1.00	22,331	1.00	21,390
EDN200/GN	11/10/2012	801957	OFFICE ASSISTANT III	N	SR08	03	T	A			0.50	12,834
EDN400/MD	11/10/2012	59062	CAFETERIA HELPER	N	BC02	01	T	B			0.50	16,614
EDN100/AA	11/10/2012	16301	SCHOOL CUSTODIAN III	N	WS02	01	P	A	1.00	35,544	1.00	35,544
EDN150/YC	11/10/2012	58476	BEHAVIORAL HLTH SPCLT IV	N	SR22	13	T	A	1.00	42,066	1.00	45,576
EDN100/AA	11/14/2012	801636	SCHOOL SAFETY AND SECURITY OFFICER	Certificated	SR13	04	T	A			1.00	31,212
EDN400/MD	11/15/2012	41060	CAFETERIA HELPER	N	BC02	01	T	B	0.50	5,192	0.50	8,629
EDN400/MD	11/15/2012	28143	CAFETERIA HELPER	N	BC02	01	T	B			0.50	16,614
EDN400/MD	11/15/2012	52508	CAFETERIA HELPER	N	BC02	01	T	B			0.50	16,614
EDN400/MD	11/15/2012	31648	CAFETERIA HELPER	N	BC02	01	T	B			0.50	16,614
EDN400/MD	11/15/2012	27696	CAFETERIA HELPER	N	BC02	01	T	B	0.50	5,192	0.50	16,614
EDN400/MD	11/15/2012	59894	CAFETERIA HELPER	N	BC02	01	T	B			0.50	16,614
EDN400/MD	11/15/2012	59896	CAFETERIA HELPER	N	BC02	01	T	B			0.50	16,614
EDN100/AA	11/15/2012	41719	CLERK TYPIST II	N	SR08	03	P	A	1.00	26,700	1.00	26,700
EDN400/MD	11/15/2012	9889	CAFETERIA HELPER	N	BC02	01	T	B	1.00	12,012	1.00	33,228
EDN150/YC	11/15/2012	58208	CLINICAL PSYCHOLOGIST VI	N	SR26	13	P	A	1.00	60,939	1.00	55,500
EDN150/YC	11/16/2012	59135	OFFICE ASSISTANT III	N	SR08	03	T	A	0.50	11,846	0.50	6,664
EDN150/YC	11/16/2012	59130	OFFICE ASSISTANT III	N	SR08	03	T	A	0.50	12,809	0.50	6,664
EDN150/FA	11/16/2012	58941	EDUC ASST I	Y	SR08	03	P	A	0.50	14,193	0.50	10,695
EDN150/YG	11/16/2012	59573	BEHAVIORAL HLTH SPCLT IV	N	SR22	13	P	A	1.00	42,049	1.00	45,576
EDN100/AA	11/16/2012	64245	ELEM TEACHER	Certificated	T03	05	P	A	1.00	43,048	1.00	47,287
EDN300/KF	11/16/2012	22467	ACCOUNTANT IV	N	SR22	13	P	A	1.00	47,945	1.00	53,352
EDN300/KD	11/16/2012	59881	AUDITOR V	N	SR24	13	P	A	1.00	46,131	1.00	60,024
EDN400/MD	11/17/2012	51653	CAFETERIA HELPER	N	BC02	01	P	B	0.50	5,192	0.50	16,614
EDN300/UA	11/17/2012	59057	DP USER SUPPORT TECH II	N	SR15	03	P	N			1.00	36,516
EDN300/KO	11/17/2012	8762	PERSONNEL TECHNICIAN VI	N	SR15	03	P	A	1.00	30,193	1.00	36,516
EDN150/YC	11/17/2012	58347	BEHAVIORAL HLTH SPCLT III	N	SR20	13	P	A	1.00	51,226	1.00	42,132
EDN100/AA	11/17/2012	65710	VICE PRINCIPAL II	Certificated	E04	06	T	A	1.00	72,480	1.00	67,202
EDN150/FA	11/20/2012	800963	EDUC ASST III	Y	SR12	03	P	A	0.50	12,158	0.50	12,515
EDN400/MD	11/20/2012	44430	CAFETERIA HELPER	N	BC02	01	T	B			1.00	33,228
EDN100/AA	11/22/2012	67814	SECONDARY TEACHER	Certificated	T03	05	P	A	1.00	46,120	1.00	47,287
EDN150/FA	11/24/2012	74516	GEN EDUC/ARTICLE VI TCHR	Certificated	T03	05	P	A	1.00	47,366	1.00	48,706
EDN100/AA	11/24/2012	603644	ELEM TEACHER	Certificated	T03	05	T	A			1.00	53,990
EDN100/AA	11/24/2012	71582	ELEM TEACHER	Certificated	T06	05	P	A	1.00	52,296	1.00	54,787
EDN100/AA	11/27/2012	59980	SCHOOL CUSTODIAN II	N	BC02	01	P	A	0.50	16,614	0.50	16,614
EDN150/FA	11/27/2012	32026	EDUC ASST III	Y	SR12	03	P	A	0.87	23,911	0.88	24,614
EDN150/FA	11/27/2012	800085	EDUC ASST II	Y	SR10	03	T	A	1.00	26,248	1.00	25,030
EDN100/AA	11/27/2012	61229	ELEM TEACHER	Certificated	T02	05	T	A	1.00	43,048	1.00	45,098
EDN100/AA	11/27/2012	602816	SECONDARY TEACHER	Certificated	T07	05	T	A			1.00	61,611
EDN100/AA	11/28/2012	29441	SCHOOL HEALTH AIDE	N	SR09	03	P	A	1.00	19,575	1.00	20,336
EDN100/AA	11/28/2012	30674	SCHOOL SECURITY ATTENDANT	N	SR07	03	P	A	1.00	23,229	1.00	22,250
EDN150/FA	11/28/2012	71961	SPEC ED TEACHER	Certificated	T03	05	P	A			1.00	45,909

Department of Education
Personnel Separations

Table 15

Prog ID/Org	Separation Date	Position Number	Position Title	Exempt (Y/N)	SR Level	BU Code	T/P	MOF	Budgeted FTE	Budgeted Salary	Actual FTE	Actual Salary
EDN100/AA	11/29/2012	55269	CLERK III	N	SR08	03	T	A	0.50	12,834	0.50	12,834
EDN100/AA	11/29/2012	802202	EDUC ASST III	Y	SR12	03	T	A			0.75	18,773
EDN150/FA	12/1/2012	56846	EDUC ASST III	Y	SR12	03	T	A	0.50	14,193	0.50	14,610
EDN150/NB	12/1/2012	59684	OFFICE ASSISTANT II	N	SR06	03	T	N			0.50	16,878
EDN100/AA	12/1/2012	55617	SCHOOL SECURITY ATTENDANT	N	SR07	03	P	A	1.00	25,087	1.00	24,030
EDN100/AA	12/1/2012	18035	OFFICE ASSISTANT III	N	SR08	03	P	A	1.00	26,700	1.00	26,700
EDN400/OC	12/1/2012	55076	ENGINEER V	N	SR26	13	P	A	1.00	63,026	1.00	28,814
EDN150/FA	12/1/2012	57138	EDUC ASST III	Y	SR12	03	P	A	1.00	28,385	1.00	29,220
EDN150/NB	12/1/2012	43843	ACCOUNT CLERK III	N	SR11	03	T	N			1.00	30,036
EDN100/AA	12/1/2012	14712	OFFICE ASSISTANT III	N	SR08	03	P	A	1.00	32,424	1.00	32,424
EDN400/MD	12/1/2012	12172	CAFETERIA HELPER	N	BC02	01	P	B	1.00	10,385	1.00	33,228
EDN100/AA	12/1/2012	28379	SCHOOL CUSTODIAN II	N	BC02	01	P	A	1.00	33,228	1.00	33,228
EDN100/AA	12/1/2012	45112	LIBRARY ASSISTANT III	N	SR07	03	P	A	1.00	35,064	1.00	35,064
EDN100/AA	12/1/2012	14699	OFFICE ASSISTANT III	N	SR08	03	P	A	1.00	35,064	1.00	35,064
EDN100/AA	12/1/2012	16596	SCHOOL CUSTODIAN III	N	WS02	01	P	A	1.00	35,544	1.00	35,544
EDN100/AA	12/1/2012	60475	ELEM TEACHER	Certificated	T02	05	P	A	1.00	43,048	1.00	45,098
EDN400/OC	12/1/2012	10169	SECRETARY II	N	SR14	03	P	W			1.00	49,932
EDN200/GN	12/1/2012	57934	ADMINISTRATIVE SERVICES ASST	N	SR22	13	P	A	1.00	46,947	1.00	51,312
EDN400/OC	12/1/2012	59887	ENERGY CONSERVATION COORD	N	SR24	13	P	A	1.00	36,756	1.00	51,312
EDN100/AA	12/1/2012	65298	SECONDARY TEACHER	Certificated	T06	05	P	A	1.00	55,482	1.00	58,124
EDN300/KF	12/1/2012	1813	ACCOUNTANT V	N	SR24	13	P	A	1.00	63,107	1.00	70,224
EDN100/AA	12/4/2012	63927	SECONDARY TEACHER	Certificated	T03	05	P	A	1.00	74,436	0.50	23,643
EDN100/AA	12/4/2012	45204	OFFICE ASSISTANT III	N	SR08	03	P	A	1.00	27,756	1.00	27,756
EDN400/MD	12/7/2012	802417	CAFETERIA HELPER	N	BC02	01	T	B			0.50	16,614
EDN150/FA	12/7/2012	57467	EDUC ASST III	Y	SR12	03	T	A	0.75	20,495	0.75	21,097
EDN150/YC	12/7/2012	800861	BEHAVIORAL HLTH SPCLT IV	N	SR22	13	T	A	1.00	42,066	1.00	45,576
EDN150/FA	12/8/2012	55659	EDUC ASST III	Y	SR12	03	P	A	0.50	12,158	0.50	12,515
EDN150/NB	12/8/2012	802222	EDUC ASST III	Y	SR12	03	T	N			1.00	25,030
EDN100/AA	12/8/2012	800669	GEN PROF IV	N	SR22	13	T	A	1.00	45,576	1.00	45,576
EDN150/FA	12/8/2012	63852	SPEC ED TCHR/PRE-SCHOOL	Certificated	T03	05	P	A	1.00	42,602	1.00	45,909
EDN150/YG	12/11/2012	801817	SOCIAL WORKER IV	N	SR22	13	P	A			1.00	23,663
EDN100/AA	12/13/2012	72548	ELEM TEACHER	Certificated	T03	05	P	A	1.00	41,794	1.00	47,287
EDN300/KO	12/15/2012	800126	EDUC ASST I	Y	SR08	03	T	A			1.00	13,327
EDN400/MD	12/15/2012	39598	CAFETERIA HELPER	N	BC02	01	P	B			0.50	16,614
EDN150/NB	12/15/2012	802449	EDUC ASST II	Y	SR10	03	T	N			1.00	23,130
EDN100/AA	12/15/2012	40086	OFFICE ASSISTANT III	N	SR08	03	P	A	1.00	33,756	1.00	33,756
EDN100/AA	12/15/2012	61067	LIBRARIAN	Certificated	T03	05	T	A	1.00	56,382	1.00	34,799
EDN150/FA	12/15/2012	65993	SPEC ED TEACHER	Certificated	T03	05	P	A	1.00	51,755	1.00	45,909
EDN100/AA	12/15/2012	602684	ELEM TEACHER	Certificated	T04	05	T	A			1.00	47,746
EDN100/AA	12/18/2012	55594	OFFICE ASSISTANT III	N	SR08	03	P	A	1.00	28,836	1.00	25,668
EDN150/YC	12/18/2012	59637	SCHOOL PSYCHOLOGIST	Y	SR24	13	T	A	1.00	47,360	1.00	26,644
EDN150/SA	12/19/2012	56309	OCC THERAPIST IV	N	SR22	13	P	A	1.00	52,019	1.00	23,663
EDN100/BM	12/25/2012	801113	ATHLETIC HLTH CARE TRAINER	Y	SR22	13	P	A	1.00	43,768	1.00	47,412
EDN100/AA	12/25/2012	61775	ELEM TEACHER	Certificated	T03	05	P	A	1.00	47,886	1.00	50,167
EDN100/AA	12/28/2012	58843	SCHOOL CUSTODIAN II	N	BC02	01	P	A	0.50	16,614	0.50	16,614

Prog ID/Org	Separation Date	Position Number	Position Title	Exempt (Y/N)	SR Level	BU Code	T/P	MOF	Budgeted FTE	Budgeted Salary	Actual FTE	Actual Salary
EDN400/MD	12/29/2012	32454	CAFETERIA HELPER	N	BC02	01	P	B			0.50	16,614
EDN100/AA	12/29/2012	16543	SCHOOL CUSTODIAN II	N	BC02	01	P	A	0.50	16,614	0.50	16,614
EDN100/AA	12/29/2012	55005	SCHOOL CUSTODIAN II	N	BC02	01	P	A	0.50	16,614	0.50	16,614
EDN150/FA	12/29/2012	50786	EDUC ASST III	Y	SR12	03	T	A	0.75	20,495	0.75	21,097
EDN150/FA	12/29/2012	54831	EDUC ASST III	Y	SR12	03	P	A	0.75	21,289	0.75	21,915
EDN100/AA	12/29/2012	29329	SCHOOL HEALTH AIDE	N	SR09	03	P	A	1.00	22,852	1.00	23,741
EDN100/AA	12/29/2012	29516	SCHOOL HEALTH AIDE	N	SR09	03	P	A	1.00	23,798	1.00	24,724
EDN150/FA	12/29/2012	55518	EDUC ASST III	Y	SR12	03	P	A	1.00	25,266	1.00	26,010
EDN100/AA	12/29/2012	4956	OFFICE ASSISTANT III	N	SR08	03	P	A	1.00	28,836	1.00	28,836
EDN100/AA	12/29/2012	45208	OFFICE ASSISTANT III	N	SR08	03	P	A	1.00	28,836	1.00	28,836
EDN100/AA	12/29/2012	41762	OFFICE ASSISTANT III	N	SR08	03	P	A	1.00	28,836	1.00	28,836
EDN100/AA	12/29/2012	33156	SCHOOL SECURITY ATTENDANT	N	SR07	03	P	A	1.00	30,506	1.00	29,220
EDN150/SA	12/29/2012	54663	SPEECH PATHOLOGIST IV	Y	SR22	13	P	A	0.50	31,876	0.50	30,012
EDN150/FA	12/29/2012	32044	EDUC ASST III	Y	SR12	03	P	A	1.00	30,736	1.00	31,640
EDN100/AA	12/29/2012	56503	OFFICE ASSISTANT III	N	SR08	03	P	A	1.00	32,424	1.00	32,424
EDN100/AA	12/29/2012	23586	OFFICE ASSISTANT III	N	SR08	03	P	A	1.00	32,424	1.00	32,424
EDN150/FA	12/29/2012	52709	EDUC ASST III	Y	SR12	03	P	A	1.00	31,959	1.00	32,900
EDN150/FA	12/29/2012	39113	TEACHING ASST I	Y	SR12	03	P	A	1.00	31,959	1.00	32,900
EDN150/FA	12/29/2012	32157	EDUC ASST III	Y	SR12	03	P	A	1.00	31,959	1.00	32,900
EDN100/AA	12/29/2012	16607	SCHOOL CUSTODIAN II	N	BC02	01	P	A	1.00	33,228	1.00	33,228
EDN100/AA	12/29/2012	26548	SCHOOL CUSTODIAN II	N	BC02	01	P	A	1.00	33,228	1.00	33,228
EDN100/AA	12/29/2012	19255	SCHOOL CUSTODIAN II	N	BC02	01	P	A	1.00	33,228	1.00	33,228
EDN100/AA	12/29/2012	16557	SCHOOL CUSTODIAN II	N	BC02	01	P	A	1.00	33,228	1.00	33,228
EDN400/MD	12/29/2012	1942	CAFETERIA HELPER	N	BC02	01	P	B			1.00	33,228
EDN100/AA	12/29/2012	25821	SCHOOL CUSTODIAN II	N	BC02	01	P	A	1.00	33,228	1.00	33,228
EDN400/MD	12/29/2012	59666	CAFETERIA HELPER	N	BC02	01	P	B	1.00	10,385	1.00	33,228
EDN100/AA	12/29/2012	48304	SCHOOL CUSTODIAN II	N	BC02	01	P	A	1.00	33,228	1.00	33,228
EDN400/OC	12/29/2012	14195	OFFICE ASSISTANT I	N	SR04	03	P	A	1.00	25,117	1.00	33,756
EDN100/AA	12/29/2012	56619	ACCOUNT CLERK III	N	SR11	03	P	A	1.00	33,756	1.00	33,756
EDN100/AA	12/29/2012	19061	OFFICE ASSISTANT III	N	SR08	03	P	A	1.00	33,756	1.00	33,756
EDN400/OC	12/29/2012	16803	POWER MOWER OPERATOR I	N	BC03	01	P	A	1.00	30,682	1.00	34,164
EDN150/FA	12/29/2012	37026	EDUC ASST III	Y	SR12	03	P	A	1.00	33,223	1.00	34,200
EDN400/OD	12/29/2012	16394	SCHOOL CUSTODIAN III	N	WS02	01	P	A	1.00	35,544	1.00	35,544
EDN100/AA	12/29/2012	59823	SCHOOL CUSTODIAN III	N	WS02	01	P	A	1.00	35,544	1.00	35,544
EDN100/AA	12/29/2012	16482	SCHOOL CUSTODIAN III	N	WS02	01	P	A	1.00	35,544	1.00	35,544
EDN100/AA	12/29/2012	16078	SCHOOL CUSTODIAN III	N	WS02	01	P	A	1.00	35,544	1.00	35,544
EDN150/FA	12/29/2012	29642	EDUC ASST III	Y	SR12	03	P	A	1.00	34,554	1.00	35,570
EDN400/MD	12/29/2012	13638	SCHOOL COOK II	N	BC06	01	P	B	1.00	12,012	1.00	38,436
EDN400/MD	12/29/2012	9307	SCHOOL BAKER	N	BC06	01	P	B			1.00	38,436
EDN400/MD	12/29/2012	14643	SCHOOL BAKER	N	BC06	01	P	B	1.00	12,012	1.00	38,436
EDN400/MD	12/29/2012	9252	SCHOOL COOK II	N	BC06	01	P	B	1.00	12,012	1.00	38,436
EDN400/MD	12/29/2012	9284	SCHOOL COOK II	N	BC06	01	P	B	1.00	12,012	1.00	38,436
EDN100/AA	12/29/2012	18073	SCHOOL CUSTODIAN IV	N	F102	02	P	A	1.00	42,192	1.00	38,928
EDN200/GN	12/29/2012	29996	BILINGUAL/BICULTURAL S/H ASST	Y	SR11	03	T	A	1.00	35,862	1.00	39,480
EDN100/AA	12/29/2012	16626	SCHOOL CUSTODIAN IV	N	F102	02	P	A	1.00	40,500	1.00	40,500

Prog ID/Org	Separation Date	Position Number	Position Title	Exempt (Y/N)	SR Level	BU Code	T/P	MOF	Budgeted FTE	Budgeted Salary	Actual FTE	Actual Salary
EDN100/AA	12/29/2012	68450	SECONDARY TEACHER	Certificated	T02	05	P	A	1.00	45,138	1.00	42,509
EDN400/OC	12/29/2012	43534	BUILDING MAINTENANCE WORKER I	N	BC09	01	P	A	1.00	40,004	1.00	44,544
EDN400/YA	12/29/2012	17247	SCHOOL BUS TRANSP OFFCR III	N	SR18	03	P	A	1.00	39,995	1.00	48,048
EDN100/AA	12/29/2012	3954	SCHOOL ADM SERVICES ASST III	Certificated	SR16	04	P	A	1.00	48,048	1.00	48,048
EDN400/MD	12/29/2012	17409	SCHOOL FOOD SERVICES MGR III	N	F206	02	P	B			1.00	50,040
EDN150/SA	12/29/2012	30843	HUMAN SVCS PROF IV	N	SR22	13	P	A	1.00	48,677	1.00	51,312
EDN150/SA	12/29/2012	28718	OCC THERAPIST IV	N	SR22	13	P	A	1.00	56,680	1.00	51,312
EDN150/SA	12/29/2012	50478	SOCIAL WORKER IV	N	SR22	13	P	A	1.00	50,612	1.00	53,352
EDN150/SA	12/29/2012	31329	SOCIAL WORKER IV	N	SR22	13	P	A	1.00	52,649	1.00	55,500
EDN300/KO	12/29/2012	59125	PERSONNEL MGMT SPECIALIST V	N	SR24	13	P	A	1.00	49,642	1.00	55,500
EDN200/GN	12/29/2012	57936	ADMINISTRATIVE SERVICES ASST	N	SR22	13	P	A	1.00	59,398	1.00	64,920
EDN150/SA	12/29/2012	30415	SPEECH PATHOLOGIST IV	Y	SR22	13	P	A	1.00	63,937	1.00	67,488
EDN100/AA	12/29/2012	800670	GEN PROF V	N	SR24	13	T	A	1.00	75,960	1.00	75,960
EDN400/OC	12/30/2012	52482	POWER MOWER OPERATOR I	N	BC03	01	P	A	1.00	30,682	1.00	34,164
EDN100/AA	12/31/2012	60501	ELEM TEACHER	Certificated	T07	05	P	A	0.50	31,275	0.50	30,806
EDN200/GN	12/31/2012	603675	COMPLEX AREA TEACHER	Certificated	T07	05	T	A			0.50	35,712
EDN150/FA	12/31/2012	34893	EDUC ASST III	Y	SR12	03	P	A	1.00	35,952	1.00	37,010
EDN150/FB	12/31/2012	11390	HEAD HSEARENT FOR DEAF/BLIND	N	HE07	10	P	A	1.00	34,346	1.00	37,248
EDN100/AA	12/31/2012	61729	SECONDARY TEACHER	Certificated	T02	05	P	A	1.00	47,039	1.00	49,279
EDN150/NB	12/31/2012	32931	SECRETARY II	N	SR14	03	T	N			1.00	49,932
EDN100/AA	12/31/2012	68888	ELEM TEACHER	Certificated	T04	05	P	A	1.00	48,351	1.00	50,654
EDN150/FA	12/31/2012	60994	SPEC ED TEACHER	Certificated	T04	05	P	A	1.00	47,851	1.00	50,654
EDN150/FA	12/31/2012	603157	SPEC ED TEACHER	Certificated	T03	05	T	A			1.00	51,673
EDN150/FA	12/31/2012	64712	SPEC ED TEACHER	Certificated	T04	05	P	A	1.00	69,496	1.00	52,173
EDN100/AA	12/31/2012	75367	12-MO STUDENT SVCS COORD	Certificated	T05	05	T	A			1.00	54,260
EDN100/AA	12/31/2012	61731	SECONDARY TEACHER	Certificated	T04	05	P	A	1.00	53,818	1.00	55,352
EDN100/AA	12/31/2012	75292	12-MO STUDENT SVCS COORD	Certificated	T06	05	T	A	1.00	68,749	1.00	56,431
EDN100/AA	12/31/2012	69559	ELEM TEACHER	Certificated	T05	05	T	A	1.00	55,930	1.00	57,565
EDN150/FA	12/31/2012	73670	SPEC ED TEACHER	Certificated	T07	05	P	A	1.00	54,860	1.00	58,074
EDN100/AA	12/31/2012	71177	ELEM TEACHER	Certificated	T07	05	P	A	1.00	57,098	1.00	59,818
EDN100/AA	12/31/2012	63119	ELEM TEACHER	Certificated	T06	05	P	A	1.00	57,145	1.00	59,867
EDN100/AA	12/31/2012	601771	10-MO STUDENT SVCS COORD	Certificated	T07	05	T	A			1.00	61,611
EDN100/AA	12/31/2012	68623	SECONDARY TEACHER	Certificated	T03	05	P	A	1.00	58,295	1.00	62,590
EDN100/AA	12/31/2012	64114	ELEM TEACHER	Certificated	T05	05	P	A	1.00	61,025	1.00	62,903
EDN100/AA	12/31/2012	63237	ELEM TEACHER	Certificated	T05	05	P	A	1.00	63,861	1.00	62,903
EDN100/AA	12/31/2012	66679	ELEM TEACHER	Certificated	T02	05	P	A	1.00	51,400	1.00	63,326
EDN100/AA	12/31/2012	66762	ELEM TEACHER	Certificated	T07	05	P	A	1.00	61,793	1.00	63,460
EDN100/AA	12/31/2012	63266	ELEM TEACHER	Certificated	T05	05	P	A	1.00	61,845	1.00	64,791
EDN100/AA	12/31/2012	74620	VICE PRINCIPAL I	Certificated	E03	06	P	A	1.00	71,478	1.00	66,273
EDN100/AA	12/31/2012	71033	ELEM TEACHER	Certificated	T07	05	P	A	1.00	64,264	1.00	67,325
EDN100/AA	12/31/2012	603415	ELEM TEACHER	Certificated	T07	05	T	A			1.00	67,325
EDN100/AA	12/31/2012	67912	ELEM TEACHER	Certificated	T07	05	P	A	1.00	65,482	1.00	67,325
EDN100/AA	12/31/2012	63146	ELEM TEACHER	Certificated	T07	05	P	A	1.00	64,264	1.00	67,325
EDN100/AA	12/31/2012	601747	ELEM TEACHER	Certificated	T07	05	T	A			1.00	67,325
EDN100/AA	12/31/2012	69949	SECONDARY TEACHER	Certificated	T07	05	T	A	1.00	64,264	1.00	67,325

<u>Prog ID/Org</u>	<u>Separation Date</u>	<u>Position Number</u>	<u>Position Title</u>	<u>Exempt (Y/N)</u>	<u>SR Level</u>	<u>BU Code</u>	<u>T/P</u>	<u>MOF</u>	<u>Budgeted FTE</u>	<u>Budgeted Salary</u>	<u>Actual FTE</u>	<u>Actual Salary</u>
EDN100/AA	12/31/2012	600088	ELEM TEACHER	Certificated	T07	05	T	A			1.00	67,325
EDN100/AA	12/31/2012	67380	ELEM TEACHER	Certificated	T07	05	P	A	1.00	66,191	1.00	69,344
EDN200/GN	12/31/2012	72461	COMPLEX AREA TEACHER	Certificated	T07	05	P	A	1.00	49,558	1.00	69,344
EDN100/AA	12/31/2012	72558	ELEM TEACHER	Certificated	T07	05	P	A	1.00	70,400	1.00	69,344
EDN100/AA	12/31/2012	71062	ELEM TEACHER	Certificated	T07	05	P	A	1.00	66,191	1.00	69,344
EDN100/AA	12/31/2012	71198	ELEM TEACHER	Certificated	T07	05	P	A	1.00	68,936	1.00	69,344
EDN100/AA	12/31/2012	62257	ELEM TEACHER	Certificated	T07	05	P	A	1.00	66,191	1.00	69,344
EDN100/AA	12/31/2012	74555	ELEM TEACHER	Certificated	T07	05	P	A	1.00	66,191	1.00	69,344
EDN150/FA	12/31/2012	66715	SPEC ED TEACHER	Certificated	T07	05	P	A	1.00	65,506	1.00	69,344
EDN150/FA	12/31/2012	602554	SPEC ED TCHR/PRE-SCHOOL	Certificated	T07	05	T	A			1.00	69,344
EDN100/AA	12/31/2012	67503	12-MO ELEM TEACHER	Certificated	T07	05	P	A	1.00	79,429	1.00	69,344
EDN150/FA	12/31/2012	64291	GEN EDUC/ARTICLE VI TCHR	Certificated	T07	05	P	A			1.00	69,344
EDN100/AA	12/31/2012	73192	12-MONTH REGISTRAR	Certificated	T06	05	P	A	1.00	84,553	1.00	69,404
EDN100/AA	12/31/2012	67254	12-MONTH REGISTRAR	Certificated	T05	05	P	A	1.00	86,178	1.00	70,737
EDN150/FA	12/31/2012	69760	SPEC ED TEACHER	Certificated	T07	05	P	A	1.00	67,472	1.00	71,425
EDN100/AA	12/31/2012	61290	ELEM TEACHER	Certificated	T07	05	P	A	1.00	69,160	1.00	71,425
EDN100/AA	12/31/2012	67047	ELEM TEACHER	Certificated	T07	05	P	A	1.00	68,177	1.00	71,425
EDN100/AA	12/31/2012	62212	ELEM TEACHER	Certificated	T07	05	T	A	1.00	68,177	1.00	71,425
EDN150/FA	12/31/2012	64310	SPEC ED TCHR/PRE-SCHOOL	Certificated	T07	05	P	A	1.00	63,653	1.00	71,425
EDN100/AA	12/31/2012	68470	COUNSELOR	Certificated	T07	05	P	A	1.00	72,513	1.00	71,425
EDN100/AA	12/31/2012	60244	12-MO SECONDARY TEACHER	Certificated	T07	05	P	A	1.00	81,813	1.00	71,425
EDN100/DB	12/31/2012	75095	DIST OFF TCHR	Certificated	T07	05	T	N			1.00	73,567
EDN100/AA	12/31/2012	62573	SECONDARY TEACHER	Certificated	T06	05	P	A	1.00	70,222	1.00	73,567
EDN100/DE	12/31/2012	79320	STATE OFFICE TEACHER	Certificated	T07	05	T	N			1.00	73,567
EDN150/NB	12/31/2012	79905	12-MO STATE OFF TCHR	Certificated	T07	05	T	N	1.00	89,626	1.00	73,567
EDN150/FA	12/31/2012	74780	SPEC ED TEACHER	Certificated	T07	05	P	A	1.00	69,496	1.00	73,567
EDN100/AA	12/31/2012	63403	SECONDARY TEACHER	Certificated	T06	05	P	A	1.00	60,627	1.00	74,693
EDN100/AA	12/31/2012	72424	SECONDARY TEACHER	Certificated	T07	05	P	A	1.00	74,436	1.00	77,982
EDN100/AA	12/31/2012	65507	ELEM TEACHER	Certificated	T07	05	P	A	1.00	74,436	1.00	77,982
EDN100/AA	12/31/2012	66704	SECONDARY TEACHER	Certificated	T07	05	P	A	1.00	74,436	1.00	77,982
EDN100/AA	12/31/2012	62941	ELEM TEACHER	Certificated	T07	05	P	A	1.00	74,436	1.00	77,982
EDN150/FA	12/31/2012	72582	SPEC ED TEACHER	Certificated	T07	05	P	A	1.00	73,666	1.00	77,982
EDN100/AA	12/31/2012	73158	COUNSELOR	Certificated	T07	05	P	A	1.00	79,170	1.00	77,982
EDN100/AA	12/31/2012	62711	COUNSELOR/ALIENATION	Certificated	T07	05	P	A	1.00	74,436	1.00	77,982
EDN100/AA	12/31/2012	68317	SECONDARY TEACHER	Certificated	T07	05	P	A	1.00	74,436	1.00	77,982
EDN100/AA	12/31/2012	75217	12-MO STUDENT SVCS COORD	Certificated	T07	05	T	A			1.00	77,982
EDN100/AA	12/31/2012	69073	ELEM TEACHER	Certificated	T07	05	P	A	1.00	75,419	1.00	77,982
EDN100/AA	12/31/2012	74614	VICE PRINCIPAL III	Certificated	E05	06	P	A	1.00	86,837	1.00	80,514
EDN100/AA	12/31/2012	62556	SCH ATHLETIC DIR III	Certificated	E03	06	P	A	1.00	82,616	1.00	82,616
EDN500/PC	12/31/2012	601021	COMM SCH VICE PRIN III	Certificated	E05	06	T	A	1.00	90,930	1.00	88,746
EDN100/AA	12/31/2012	64912	VICE PRINCIPAL IV	Certificated	E06	06	P	A	1.00	77,698	1.00	91,247
EDN100/AA	12/31/2012	61653	SCH ATHLETIC DIR III	Certificated	E03	06	P	A	1.00	92,334	1.00	92,334
EDN200/GP	12/31/2012	60019	TEST DEV & ADM SPEC III	Certificated	E08	06	P	A	1.00	86,014	1.00	96,267
EDN100/AA	12/31/2012	65462	12-MO INTER PRIN V	Certificated	E08	06	P	A	1.00	113,147	1.00	113,147
EDN100/AA	12/31/2012	69585	12-MO ELEM PRIN III	Certificated	E07	06	P	A	1.00	116,338	1.00	116,338

Department of Education
Personnel Separations

Table 15

<u>Prog ID/Org</u>	<u>Separation Date</u>	<u>Position Number</u>	<u>Position Title</u>	<u>Exempt (Y/N)</u>	<u>SR Level</u>	<u>BU Code</u>	<u>T/P</u>	<u>MOF</u>	<u>Budgeted FTE</u>	<u>Budgeted Salary</u>	<u>Actual FTE</u>	<u>Actual Salary</u>
EDN100/AA	12/31/2012	61570	12-MO ELEM PRIN III	Certificated	E07	06	P	A	1.00	119,617	1.00	119,617
EDN100/AA	12/31/2012	60490	12-MO ELEM PRIN II	Certificated	E06	06	P	A	1.00	97,103	1.00	122,991
EDN100/AA	12/31/2012	61103	12-MO ELEM PRIN III	Certificated	E07	06	P	A	1.00	124,714	1.00	124,714
EDN100/AA	12/31/2012	62328	12-MO HS PRIN VII	Certificated	E10	06	P	A	1.00	137,459	1.00	137,459
EDN150/FA	1/1/2013	57443	EDUC ASST III	Y	SR12	03	T	A	0.50	14,193	0.50	14,610
EDN400/MD	1/1/2013	11479	CAFETERIA HELPER	N	BC02	01	P	B	0.50	5,192	0.50	16,614
EDN150/FA	1/1/2013	55130	EDUC ASST III	Y	SR12	03	P	A	0.75	19,686	0.75	18,773
EDN150/FA	1/1/2013	57335	EDUC ASST III	Y	SR12	03	P	A	0.75	20,495	0.75	21,097
EDN150/FA	1/1/2013	55741	EDUC ASST III	Y	SR12	03	T	A	1.00	25,266	1.00	25,030
EDN100/AA	1/1/2013	36388	OFFICE ASSISTANT III	N	SR08	03	P	A	1.00	37,968	1.00	28,836
EDN400/MD	1/1/2013	801558	FOOD SERVICES DRIVER	N	BC03	01	T	B			1.00	34,164
EDN400/MD	1/1/2013	11379	SCHOOL BAKER	N	BC06	01	P	B	1.00	12,012	1.00	38,436
EDN100/AA	1/1/2013	61035	SECONDARY TEACHER	Certificated	T02	05	P	A	1.00	48,351	1.00	42,509
EDN150/FA	1/1/2013	73008	SPEC ED TEACHER	Certificated	T02	05	P	A	1.00	40,157	1.00	42,509
EDN150/FA	1/1/2013	75567	GEN EDUC/ARTICLE VI TCHR	Certificated	T02	05	T	A	1.00	40,285	1.00	42,509
EDN150/YC	1/1/2013	58635	BEHAVIORAL HLTH SPLCT IV	N	SR22	13	P	A	1.00	42,066	1.00	45,576
EDN150/SA	1/1/2013	56275	SPEECH PATHOLOGIST IV	Y	SR22	13	P	A	1.00	54,027	1.00	45,576
EDN100/AA	1/1/2013	67916	COUNSELOR	Certificated	T03	05	P	A	1.00	52,460	1.00	45,909
EDN100/AA	1/1/2013	68351	ELEM TEACHER	Certificated	T03	05	T	A	1.00	46,492	1.00	48,706
EDN100/AA	1/1/2013	63629	SECONDARY TEACHER	Certificated	T04	05	P	A	1.00	75,419	1.00	50,654
EDN100/AA	1/1/2013	60222	SECONDARY TEACHER	Certificated	T07	05	P	A	1.00	58,959	1.00	54,741
EDN150/FA	1/1/2013	75985	GEN EDUC/ARTICLE VI TCHR	Certificated	T04	05	P	A	1.00	46,157	1.00	59,570
EDN300/KD	1/1/2013	74635	PROG SUPP & DEV DIRECTOR	Certificated	E10	06	P	A	1.00	105,062	1.00	116,952
EDN100/AA	1/2/2013	800941	OFFICE ASSISTANT II	N	SR06	03	T	A			0.50	11,844
EDN100/AA	1/2/2013	56794	OFFICE ASSISTANT III	N	SR08	03	T	A	0.50	12,834	0.50	12,834
EDN100/BJ	1/2/2013	69479	SECONDARY TEACHER	Certificated	T03	05	T	A			1.00	45,909
EDN100/AA	1/2/2013	64362	COUNSELOR	Certificated	T03	05	P	A	1.00	48,008	1.00	45,909
EDN300/KF	1/2/2013	1790	ACCOUNTANT V	N	SR24	13	P	A	1.00	60,648	1.00	67,488
EDN150/FA	1/3/2013	800356	EDUC ASST III	Y	SR12	03	P	A	0.50	12,158	0.50	12,515
EDN150/FA	1/3/2013	58933	EDUC ASST III	Y	SR12	03	P	A	0.75	18,237	0.75	18,773
EDN150/FA	1/3/2013	603212	SPEC ED TEACHER	Certificated	T02	05	T	A			1.00	32,222
EDN150/FA	1/3/2013	72252	SPEC ED TEACHER	Certificated	T02	05	P	A	1.00	44,671	1.00	32,222
EDN100/AA	1/3/2013	74666	ELEM TEACHER	Certificated	T02	05	T	A	1.00	47,398	1.00	42,509
EDN150/FA	1/3/2013	64394	GEN EDUC/ARTICLE VI TCHR	Certificated	T02	05	P	A	1.00	40,285	1.00	42,509
EDN100/AA	1/3/2013	65061	SECONDARY TEACHER	Certificated	T02	05	T	A	1.00	40,577	1.00	42,509
EDN100/AA	1/3/2013	61771	ELEM TEACHER	Certificated	T02	05	T	A	1.00	40,577	1.00	42,509
EDN150/FA	1/3/2013	65480	SPEC ED TEACHER	Certificated	T02	05	P	A	1.00	66,711	1.00	42,509
EDN100/AA	1/3/2013	63034	SECONDARY TEACHER	Certificated	T02	05	P	A	1.00	51,296	1.00	42,509
EDN100/AA	1/3/2013	60319	SECONDARY TEACHER	Certificated	T02	05	P	A	1.00	43,048	1.00	45,098
EDN100/AA	1/3/2013	63738	ELEM TEACHER	Certificated	T02	05	P	A	1.00	44,030	1.00	45,098
EDN100/BJ	1/3/2013	63850	SPECIAL SCH TEACHER	Certificated	T02	05	P	A	1.00	48,103	1.00	45,098
EDN100/AA	1/3/2013	72835	SECONDARY TEACHER	Certificated	T03	05	P	A	1.00	43,048	1.00	45,909
EDN100/AA	1/3/2013	602550	SECONDARY TEACHER	Certificated	T03	05	T	A			1.00	45,909
EDN100/AA	1/3/2013	63366	ELEM TEACHER	Certificated	T03	05	P	A	1.00	45,138	1.00	45,909
EDN100/AA	1/3/2013	67191	SECONDARY TEACHER	Certificated	T03	05	P	A	1.00	43,822	1.00	45,909

<u>Prog ID/Org</u>	<u>Separation Date</u>	<u>Position Number</u>	<u>Position Title</u>	<u>Exempt (Y/N)</u>	<u>SR Level</u>	<u>BU Code</u>	<u>T/P</u>	<u>MOF</u>	<u>Budgeted FTE</u>	<u>Budgeted Salary</u>	<u>Actual FTE</u>	<u>Actual Salary</u>
EDN150/FA	1/3/2013	64047	SPEC ED TEACHER	Certificated	T03	05	P	A	1.00	54,908	1.00	45,909
EDN150/YG	1/3/2013	600540	12-MO DIST OFF TCHR	Certificated	T03	05	T	A			1.00	45,909
EDN150/FA	1/3/2013	600157	SPEC ED TEACHER	Certificated	T03	05	T	A			1.00	45,909
EDN100/AA	1/3/2013	65962	ELEM TEACHER	Certificated	T03	05	P	A	1.00	46,492	1.00	45,909
EDN100/AA	1/3/2013	65151	ELEM TEACHER	Certificated	T03	05	P	A	1.00	46,492	1.00	45,909
EDN150/FA	1/3/2013	65023	GEN EDUC/ARTICLE VI TCHR	Certificated	T03	05	P	A	1.00	60,014	1.00	45,909
EDN100/AA	1/3/2013	74838	SECONDARY TEACHER	Certificated	T03	05	T	A	1.00	62,391	1.00	48,706
EDN100/AA	1/3/2013	68899	SECONDARY TEACHER	Certificated	T04	05	P	A	1.00	49,334	1.00	50,654
EDN100/AA	1/3/2013	603452	ELEM TEACHER	Certificated	T04	05	T	A			1.00	50,654
EDN100/AA	1/3/2013	63139	SECONDARY TEACHER	Certificated	T07	05	P	A	1.00	54,565	1.00	58,074
EDN100/AA	1/3/2013	63668	SECONDARY TEACHER	Certificated	T07	05	P	A	1.00	58,810	1.00	61,611
EDN150/FA	1/4/2013	68345	GEN EDUC/ARTICLE VI TCHR	Certificated	T06	05	T	A	1.00	48,003	1.00	54,787
EDN100/AA	1/4/2013	67391	COUNSELOR	Certificated	T07	05	P	A	1.00	62,024	1.00	59,818
EDN150/FA	1/5/2013	57232	EDUC ASST III	Y	SR12	03	P	A	0.75	19,686	0.75	18,773
EDN100/AA	1/5/2013	29360	SCHOOL HEALTH AIDE	N	SR09	03	P	A	1.00	22,852	1.00	23,741
EDN100/AA	1/5/2013	603404	SECONDARY TEACHER	Certificated	T02	05	T	A			1.00	32,222
EDN150/FA	1/5/2013	63712	SPEC ED TEACHER	Certificated	T02	05	P	A	1.00	40,157	1.00	37,893
EDN100/AA	1/5/2013	66665	ELEM TEACHER	Certificated	T02	05	T	A	1.00	63,374	1.00	42,509
EDN150/FA	1/5/2013	67845	GEN EDUC/ARTICLE VI TCHR	Certificated	T02	05	P	A	1.00	55,035	1.00	42,509
EDN100/AA	1/5/2013	71778	SECONDARY TEACHER	Certificated	T04	05	T	A	1.00	46,492	1.00	50,654
EDN100/BB	1/5/2013	61976	SECONDARY TEACHER	Certificated	T05	05	P	A	1.00	39,748	1.00	52,680
EDN150/FA	1/5/2013	73214	SPEC ED TCHR/PRE-SCHOOL	Certificated	T06	05	P	A	1.00	47,851	1.00	54,787
EDN150/YC	1/10/2013	58084	HUMAN SVCS PROF IV	N	SR22	13	P	A	1.00	42,066	1.00	23,663
EDN100/CN	1/10/2013	59815	PERSONNEL CLERK IV	N	SR11	03	T	A			1.00	28,836
EDN100/AA	1/10/2013	62407	LIBRARIAN	Certificated	T06	05	P	A	1.00	56,917	1.00	54,787
EDN150/FA	1/11/2013	64481	SPEC ED TEACHER	Certificated	T02	05	P	A	1.00	42,567	1.00	49,991
EDN100/AA	1/12/2013	34198	SCHOOL CUSTODIAN II	N	BC02	01	P	A	1.00	33,228	1.00	33,228
EDN150/FA	1/12/2013	67941	SPEC ED TEACHER	Certificated	T02	05	P	A	1.00	43,369	1.00	42,509
EDN150/FA	1/15/2013	55070	EDUC ASST III	Y	SR12	03	P	A	1.00	24,314	1.00	25,030
EDN200/GH	1/16/2013	57916	OFFICE ASSISTANT IV	N	SR10	03	P	B	1.00	29,635	1.00	31,212
EDN100/AA	1/16/2013	67307	SECONDARY TEACHER	Certificated	T06	05	T	A	1.00	40,577	1.00	64,430
EDN150/FA	1/17/2013	602311	SPEC ED TEACHER	Certificated	T02	05	T	A			1.00	42,509
EDN100/AA	1/17/2013	71711	ELEM TEACHER	Certificated	T04	05	P	A	1.00	50,541	1.00	59,570
EDN150/SA	1/19/2013	46661	SPEECH PATHOLOGIST IV	Y	SR22	13	P	A	1.00	54,027	1.00	45,576
EDN150/FA	1/19/2013	601233	SPEC ED TCHR/PRE-SCHOOL	Certificated	T03	05	T	A			1.00	53,990
EDN150/FA	1/22/2013	56969	EDUC ASST III	Y	SR12	03	P	A	1.00	28,385	1.00	29,220
EDN500/PC	1/23/2013	802681	OFFICE ASSISTANT III	N	SR08	03	T	A			1.00	13,327
EDN150/YG	1/23/2013	800275	EDUC ASST III	Y	SR12	03	P	A	1.00	24,109	1.00	25,030
EDN150/YC	1/23/2013	800436	SCHOOL PSYCHOLOGIST	Y	SR24	13	P	A	1.00	62,235	1.00	60,024
EDN150/YC	1/25/2013	58406	BEHAVIORAL HLTH SPCLT IV	N	SR22	13	P	A	1.00	53,264	1.00	49,332
EDN150/FA	1/26/2013	52561	EDUC ASST III	Y	SR12	03	P	A	1.00	26,248	1.00	27,020
EDN150/FA	1/26/2013	57039	EDUC ASST III	Y	SR12	03	P	A	1.00	28,385	1.00	29,220
EDN100/AA	1/26/2013	602802	SECONDARY TEACHER	Certificated	T03	05	T	A			1.00	45,909
EDN300/UA	1/26/2013	79144	DOE DECISION SUPP SPEC I	Certificated	E06	06	T	N			1.00	73,921
EDN100/AA	1/29/2013	55187	SCHOOL CUSTODIAN II	N	BC02	01	P	A	1.00	33,228	1.00	33,228

Prog ID/Org	Separation Date	Position Number	Position Title	Exempt (Y/N)	SR Level	BU Code	T/P	MOF	Budgeted FTE	Budgeted Salary	Actual FTE	Actual Salary
EDN100/AA	1/30/2013	602449	ELEM TEACHER	Certificated	T02	05	T	A			1.00	42,509
EDN100/AA	2/1/2013	59777	LIBRARY ASSISTANT III	N	SR07	03	T	A	0.50	12,324	0.50	12,324
EDN100/AA	2/1/2013	55721	OFFICE ASSISTANT III	N	SR08	03	P	A	0.50	12,834	0.50	12,834
EDN100/AA	2/1/2013	28174	SCHOOL CUSTODIAN II	N	BC02	01	P	A	0.50	16,614	0.50	16,614
EDN100/AA	2/1/2013	802208	EDUC ASST II	Y	SR10	03	T	A			0.75	17,348
EDN150/FA	2/1/2013	57030	EDUC ASST III	Y	SR12	03	T	A			0.75	18,773
EDN150/YG	2/1/2013	801848	EDUC ASST III	Y	SR12	03	T	A			1.00	25,030
EDN100/AA	2/1/2013	27302	OFFICE ASSISTANT III	N	SR08	03	P	A	1.00	28,836	1.00	25,668
EDN100/DB	2/1/2013	23369	EDUC ASST III	Y	SR12	03	T	N			1.00	29,220
EDN100/AA	2/1/2013	55344	OFFICE ASSISTANT III	N	SR08	03	T	A	1.00	32,424	1.00	32,424
EDN100/AA	2/1/2013	16582	SCHOOL CUSTODIAN II	N	BC02	01	P	A	1.00	33,228	1.00	33,228
EDN100/AA	2/1/2013	25029	SCHOOL CUSTODIAN II	N	BC02	01	P	A	1.00	33,228	1.00	33,228
EDN100/AA	2/1/2013	23876	SCHOOL CUSTODIAN III	N	WS02	01	P	A	1.00	35,544	1.00	35,544
EDN400/MD	2/1/2013	9398	SCHOOL BAKER	N	BC06	01	P	B	1.00	12,012	1.00	38,436
EDN100/AA	2/1/2013	14721	SCHOOL ADM SERVICES ASST II	Certificated	SR14	04	P	A	1.00	44,412	1.00	44,412
EDN150/SA	2/1/2013	46665	SPEECH PATHOLOGIST IV	Y	SR22	13	P	A	1.00	62,996	1.00	57,708
EDN100/AA	2/1/2013	65774	ELEM TEACHER	Certificated	T07	05	P	A	1.00	53,866	1.00	59,818
EDN150/FA	2/2/2013	56749	EDUC ASST III	Y	SR12	03	T	A	0.75	18,237	0.75	18,773
EDN150/SA	2/2/2013	56289	SPEECH PATHOLOGIST IV	Y	SR22	13	P	A	1.00	51,891	1.00	45,576
EDN150/FA	2/2/2013	66236	SPEC ED TEACHER	Certificated	T03	05	P	A	1.00	41,362	1.00	47,287
EDN100/AA	2/2/2013	67416	SECONDARY TEACHER	Certificated	T04	05	P	A	1.00	43,822	1.00	47,746
EDN100/AA	2/2/2013	74062	COUNSELOR	Certificated	T03	05	T	A	1.00	49,448	1.00	48,706
EDN150/FA	2/5/2013	601028	GEN EDUC/ARTICLE VI TCHR	Certificated	T02	05	T	A			1.00	42,509
EDN100/CB	2/7/2013	45068	SCHOOL HEALTH AIDE	N	SR09	03	P	A	1.00	17,401	1.00	18,078
EDN150/YG	2/7/2013	801071	EDUC ASST III	Y	SR12	03	P	A			1.00	30,036
EDN150/FA	2/8/2013	29640	EDUC ASST II	Y	SR10	03	P	A	0.50	14,781	0.50	11,565
EDN100/AA	2/8/2013	26563	SCHOOL CUSTODIAN II	N	BC02	01	P	A	1.00	33,228	1.00	33,228
EDN100/AA	2/8/2013	16710	SCHOOL CUSTODIAN IV	N	F102	02	P	A	1.00	38,160	1.00	36,684
EDN150/NB	2/9/2013	802483	EDUC ASST III	Y	SR12	03	T	N			1.00	25,030
EDN150/FA	2/9/2013	75487	SPEC ED TEACHER	Certificated	T02	05	T	A			1.00	45,098
EDN150/FA	2/9/2013	71013	SPEC ED TEACHER	Certificated	T03	05	P	A	1.00	41,362	1.00	47,287
EDN100/AA	2/9/2013	65654	ELEM TEACHER	Certificated	T03	05	P	A	1.00	46,492	1.00	48,706
EDN100/AA	2/12/2013	56401	OFFICE ASSISTANT III	N	SR08	03	P	A	1.00	26,700	1.00	26,700
EDN400/OC	2/15/2013	24786	CARPENTER I	N	BC09	01	P	A	1.00	43,194	1.00	23,134
EDN400/OC	2/16/2013	45351	OFFICE ASSISTANT III	N	SR08	03	P	A	1.00	26,951	1.00	13,327
EDN150/FA	2/16/2013	57348	EDUC ASST III	Y	SR12	03	P	A	0.75	18,950	0.75	19,508
EDN150/FA	2/16/2013	58008	EDUC ASST III	Y	SR12	03	T	A	0.75	20,495	0.75	21,097
EDN150/YG	2/16/2013	801381	CLERK TYPIST II	N	SR08	03	P	A	1.00	23,682	1.00	32,424
EDN100/BB	2/19/2013	63329	SECONDARY TEACHER	Certificated	T02	05	P	A	1.00	40,899	1.00	42,509
EDN150/ND	2/19/2013	79579	DIST OFF TCHR	Certificated	T07	05	T	N			1.00	58,074
EDN150/FA	2/20/2013	41365	EDUC ASST III	Y	SR12	03	P	A	1.00	28,385	1.00	29,220
EDN200/GN	2/20/2013	57962	PROFESSIONAL TRAINEE I	N	SR16	13	P	A	1.00	41,699	1.00	36,024
EDN150/FB	2/21/2013	52603	EDUC ASST III	Y	SR12	03	P	A	1.00	24,095	1.00	25,030
EDN300/KF	2/21/2013	6608	PRE AUDIT CLERK II	N	SR13	03	P	A	1.00	30,335	1.00	33,756
EDN400/MD	2/21/2013	11013	SCHOOL COOK II	N	BC06	01	P	B	1.00	12,012	1.00	38,436

Department of Education
Personnel Separations

Table 15

Prog ID/Org	Separation Date	Position Number	Position Title	Exempt (Y/N)	SR Level	BU Code	T/P	MOF	Budgeted FTE	Budgeted Salary	Actual FTE	Actual Salary
EDN100/AA	2/23/2013	110654	SCHOOL HEALTH AIDE	N	SR09	03	P	A	1.00	20,342	1.00	21,133
EDN150/FA	2/23/2013	57064	EDUC ASST III	Y	SR12	03	T	A	1.00	24,314	1.00	25,030
EDN100/BM	2/23/2013	800799	ATHLETIC HLTH CARE TRAINER	Y	SR22	13	P	A	1.00	42,073	1.00	45,576
EDN100/BJ	2/23/2013	75344	COUNSELOR	Certificated	T04	05	T	A	1.00	43,597	1.00	47,746
EDN150/YC	2/23/2013	59827	BEHAVIORAL HLTH SPCLT IV	N	SR22	13	P	A	1.00	47,360	1.00	51,312
EDN100/AA	2/23/2013	69787	COUNSELOR	Certificated	T04	05	P	A	1.00	54,358	1.00	52,173
EDN100/BS	2/23/2013	72057	ROTC INSTRUCTOR	Certificated	ROTC	05	T	A	1.00	74,050	1.00	92,916
EDN100/AA	2/26/2013	14692	OFFICE ASSISTANT III	N	SR08	03	P	A	1.00	25,668	1.00	25,668
EDN150/FA	2/26/2013	603636	SPEC ED TEACHER	Certificated	T02	05	T	A			1.00	32,222
EDN100/AA	2/27/2013	51943	OFFICE ASSISTANT III	N	SR08	03	P	A	1.00	27,756	1.00	27,756
EDN150/FA	2/27/2013	73891	SPEC ED TCHR/PRE-SCHOOL	Certificated	T03	05	P	A	1.00	43,369	1.00	45,909
EDN400/MD	3/1/2013	2075	CAFETERIA HELPER	N	BC02	01	T	B			0.50	8,629
EDN100/AA	3/1/2013	18132	SCHOOL CUSTODIAN II	N	BC02	01	P	A	0.50	16,614	0.50	8,629
EDN100/AA	3/1/2013	22652	SCHOOL CUSTODIAN II	N	BC02	01	P	A	0.50	16,614	0.50	16,614
EDN150/FA	3/1/2013	52627	EDUC ASST III	Y	SR12	03	P	A	0.75	22,171	0.75	22,823
EDN100/AA	3/1/2013	802176	OFFICE ASSISTANT III	N	SR08	03	T	A			1.00	25,668
EDN150/FA	3/1/2013	58037	EDUC ASST III	Y	SR12	03	P	A	1.00	26,248	1.00	27,020
EDN100/AA	3/1/2013	45146	OFFICE ASSISTANT II	N	SR06	03	P	A	1.00	32,424	1.00	32,424
EDN500/PC	3/1/2013	24997	OFFICE ASSISTANT III	N	SR08	03	T	A	1.00	30,803	1.00	32,424
EDN100/AA	3/1/2013	45156	OFFICE ASSISTANT II	N	SR06	03	P	A	1.00	32,424	1.00	32,424
EDN100/AA	3/1/2013	603269	ELEM TEACHER	Certificated	T07	05	T	A			0.50	32,682
EDN400/MD	3/1/2013	21302	CAFETERIA HELPER	N	BC02	01	P	B	1.00	10,385	1.00	33,228
EDN100/AA	3/1/2013	602335	COUNSELOR	Certificated	T07	05	T	A			0.50	33,663
EDN400/OC	3/1/2013	49606	TRACTOR OPERATOR	N	BC04	01	P	A	1.00	31,922	1.00	35,544
EDN400/MD	3/1/2013	41911	SCHOOL COOK II	N	BC06	01	P	B	1.00	12,012	1.00	38,436
EDN150/FA	3/1/2013	69457	SPEC ED TEACHER	Certificated	T02	05	P	A	1.00	44,813	1.00	42,509
EDN400/OC	3/1/2013	17186	BUILDING MAINTENANCE WORKER I	N	BC09	01	P	A	1.00	40,004	1.00	44,544
EDN150/YC	3/1/2013	58404	BEHAVIORAL HLTH SPCLT IV	N	SR22	13	P	A	1.00	45,533	1.00	47,412
EDN100/AA	3/1/2013	1910	SCHOOL ADM SERVICES ASST IV	Certificated	SR18	04	P	A	1.00	48,048	1.00	48,048
EDN100/AA	3/1/2013	65120	ELEM TEACHER	Certificated	T03	05	P	A	1.00	49,323	1.00	51,673
EDN100/AA	3/1/2013	68000	SECONDARY TEACHER	Certificated	T05	05	P	A	1.00	59,466	1.00	62,903
EDN100/AA	3/1/2013	71508	ELEM TEACHER	Certificated	T07	05	P	A	1.00	64,264	1.00	67,325
EDN100/BB	3/1/2013	68474	DIST OFF TCHR	Certificated	T07	05	P	A	1.00	66,785	1.00	71,425
EDN150/FA	3/1/2013	600986	SPEC ED TEACHER	Certificated	T07	05	T	A			1.00	77,982
EDN150/FA	3/2/2013	58173	EDUC ASST III	Y	SR12	03	P	A	0.75	19,686	0.75	20,265
EDN150/FA	3/2/2013	56715	EDUC ASST III	Y	SR12	03	T	A	1.00	24,314	1.00	25,030
EDN100/AA	3/2/2013	74312	SECONDARY TEACHER	Certificated	T03	05	P	A	1.00	59,617	1.00	45,909
EDN150/YC	3/2/2013	58420	BEHAVIORAL HLTH SPCLT IV	N	SR22	13	P	A	1.00	53,264	1.00	47,412
EDN150/YC	3/6/2013	59132	OFFICE ASSISTANT III	N	SR08	03	T	A	0.50	13,861	0.50	6,664
EDN100/AA	3/6/2013	603438	SPEC ED TEACHER	Certificated	T02	05	T	A			1.00	42,509
EDN100/AA	3/7/2013	25383	SCHOOL CUSTODIAN II	N	BC02	01	P	A	0.50	16,614	0.50	16,614
EDN100/AA	3/7/2013	30666	SCHOOL SECURITY ATTENDANT	N	SR07	03	P	A	1.00	22,331	1.00	21,390
EDN100/AA	3/7/2013	30668	SCHOOL SECURITY ATTENDANT	N	SR07	03	P	A	1.00	24,148	1.00	23,130
EDN400/OC	3/7/2013	18709	TRACTOR OPERATOR	N	BC04	01	P	A	1.00	31,922	1.00	35,544
EDN400/MD	3/8/2013	59643	CAFETERIA HELPER	N	BC02	01	T	B	0.50	5,192	0.50	16,614

<u>Prog ID/Org</u>	<u>Separation Date</u>	<u>Position Number</u>	<u>Position Title</u>	<u>Exempt (Y/N)</u>	<u>SR Level</u>	<u>BU Code</u>	<u>T/P</u>	<u>MOF</u>	<u>Budgeted FTE</u>	<u>Budgeted Salary</u>	<u>Actual FTE</u>	<u>Actual Salary</u>
EDN150/FA	3/8/2013	52594	EDUC ASST III	Y	SR12	03	P	A	0.75	18,237	0.75	18,773
EDN100/AA	3/8/2013	71198	ELEM TEACHER	Certificated	T02	05	P	A	1.00	68,936	1.00	42,509
EDN100/AA	3/8/2013	1830	SCHOOL ADM SERVICES ASST III	Certificated	SR16	04	P	A	1.00	42,684	1.00	42,684
EDN100/AA	3/8/2013	69449	ELEM TEACHER	Certificated	T06	05	P	A	1.00	50,285	1.00	54,787
EDN100/AA	3/9/2013	28447	SCHOOL CUSTODIAN II	N	BC02	01	P	A	0.50	16,614	0.50	16,614
EDN150/FA	3/9/2013	47129	EDUC ASST III	Y	SR12	03	P	A	1.00	24,314	1.00	25,030
EDN150/FA	3/12/2013	602351	GEN EDUC/ARTICLE VI TCHR	Certificated	T04	05	T	A			1.00	47,746
EDN150/YC	3/12/2013	58289	CLINICAL PSYCHOLOGIST V	N	SR24	13	P	A	1.00	60,939	1.00	51,312
EDN150/FB	3/13/2013	76175	12-MO HS PRIN V	Certificated	E08	06	P	A	1.00	101,472	1.00	110,046
EDN150/FA	3/15/2013	74070	SPEC ED TEACHER	Certificated	T02	05	P	A	1.00	30,536	1.00	32,222
EDN150/YG	3/16/2013	801873	EDUC ASST II	Y	SR10	03	T	A			1.00	23,130
EDN150/FA	3/16/2013	603341	SPEC ED TCHR/PRE-SCHOOL	Certificated	T02	05	T	A			1.00	42,509
EDN150/YC	3/16/2013	58093	SOCIAL WORKER IV	N	SR22	13	P	A	1.00	45,533	1.00	45,576
EDN100/AA	3/16/2013	69596	ELEM TEACHER	Certificated	T03	05	P	A	1.00	49,904	1.00	45,909
EDN100/DR	3/16/2013	79195	EVALUATION SPEC II	Certificated	E07	06	T	N			1.00	93,626
EDN100/AA	3/19/2013	800735	SCHOOL CUSTODIAN II	N	BC02	01	P	A			1.00	33,228
EDN100/AA	3/22/2013	29310	SCHOOL HEALTH AIDE	N	SR09	03	P	A	1.00	17,401	1.00	18,078
EDN100/AA	3/22/2013	54884	OFFICE ASSISTANT III	N	SR08	03	T	A	1.00	25,668	1.00	25,668
EDN100/AA	3/23/2013	52438	EDUC ASST III	Y	SR12	03	P	A	0.50	15,253	0.50	14,610
EDN150/SA	3/23/2013	30424	SPEECH PATHOLOGIST IV	Y	SR22	13	P	A	1.00	51,891	1.00	45,576
EDN150/FA	3/26/2013	52547	EDUC ASST III	Y	SR12	03	P	A	1.00	28,385	1.00	25,030
EDN400/MB	3/26/2013	801148	OFFICE ASSISTANT III	N	SR08	03	P	N	1.00	25,668	1.00	25,668
EDN100/AA	3/27/2013	603389	SECONDARY TEACHER	Certificated	T02	05	T	A			1.00	42,509
EDN150/FA	3/27/2013	67360	SPEC ED TEACHER	Certificated	T02	05	P	A			1.00	42,509
EDN100/AA	3/27/2013	74536	ELEM TEACHER	Certificated	T03	05	P	A	1.00	64,264	1.00	45,909
EDN100/AA	3/29/2013	801298	SCHOOL SECURITY ATTENDANT	N	SR07	03	T	A	1.00	21,444	1.00	20,540
EDN100/AA	3/29/2013	30581	SCHOOL SECURITY ATTENDANT	N	SR07	03	P	A	1.00	23,229	1.00	22,250
EDN100/AA	3/29/2013	801699	EDUC ASST II	Y	SR10	03	T	A			1.00	23,130
EDN150/FA	3/29/2013	801445	EDUC ASST III	Y	SR12	03	T	A			1.00	25,030
EDN150/FA	3/29/2013	29651	EDUC ASST III	Y	SR12	03	P	A	1.00	26,248	1.00	27,020
EDN100/AA	3/29/2013	69076	SECONDARY TEACHER	Certificated	T02	05	P	A	1.00	43,822	1.00	42,509
EDN100/AA	3/29/2013	71716	ELEM TEACHER	Certificated	T02	05	P	A	1.00	65,482	1.00	53,036
EDN150/YC	3/30/2013	59137	OFFICE ASSISTANT III	N	SR08	03	T	A	0.50	11,846	0.50	12,834
EDN150/YC	3/30/2013	59140	OFFICE ASSISTANT III	N	SR08	03	T	A	0.50	12,322	0.50	12,834
EDN400/OD	3/30/2013	48827	SCHOOL CUSTODIAN II	N	BC02	01	P	A	0.50	14,922	0.50	16,614
EDN400/MD	3/30/2013	801267	CAFETERIA HELPER	N	BC02	01	T	B			0.50	16,614
EDN150/YC	3/30/2013	58332	BEHAVIORAL HLTH SPCLT III	N	SR20	13	T	A	0.50	22,766	0.50	21,066
EDN100/AA	3/30/2013	27093	OFFICE ASSISTANT III	N	SR08	03	P	A	1.00	32,424	1.00	25,668
EDN150/YG	3/30/2013	800827	EDUC ASST III	Y	SR12	03	P	A	1.00	25,053	1.00	26,010
EDN100/AA	3/30/2013	16575	SCHOOL CUSTODIAN II	N	BC02	01	P	A	1.00	33,228	1.00	33,228
EDN200/GG	3/30/2013	47002	ACCOUNT CLERK III	N	SR11	03	P	A	1.00	32,804	1.00	36,516
EDN100/AA	3/30/2013	55170	OFFICE ASSISTANT III	N	SR08	03	P	A	1.00	37,968	1.00	37,968
EDN300/KF	3/30/2013	16262	PRE AUDIT CLERK II	N	SR13	03	P	A	1.00	36,881	1.00	41,040
EDN100/AA	3/30/2013	62552	SECONDARY TEACHER	Certificated	T02	05	P	A	1.00	44,339	1.00	46,451
EDN150/FA	3/30/2013	73670	SPEC ED TEACHER	Certificated	T03	05	P	A	1.00	54,860	1.00	48,706

Prog ID/Org	Separation Date	Position Number	Position Title	Exempt (Y/N)	SR Level	BU Code	T/P	MOF	Budgeted FTE	Budgeted Salary	Actual FTE	Actual Salary
EDN400/MD	3/30/2013	2054	SCHOOL FOOD SERVICES MGR III	N	F206	02	P	A	1.00	40,925	1.00	50,040
EDN100/AA	3/30/2013	1864	SCHOOL ADM SERVICES ASST III	Certificated	SR16	04	P	A	1.00	54,012	1.00	54,012
EDN150/FA	3/30/2013	74682	GEN EDUC/ARTICLE VI TCHR	Certificated	T07	05	P	A	1.00	40,285	1.00	59,818
EDN200/GD	3/30/2013	44553	AUDIOLOGIST IV	N	SR22	13	P	A	1.00	56,883	1.00	60,024
EDN200/GN	3/30/2013	800843	BUSINESS MGMT OFFICER I	N	EM05	13	P	A	1.00	65,656	1.00	71,760
EDN300/KO	3/30/2013	58571	PERSONNEL PROGRAM MGR	N	EM05	13	P	A	1.00	66,966	1.00	74,868
EDN150/FA	4/1/2013	72590	SPEC ED TEACHER	Certificated	T04	05	P	A	1.00	47,851	1.00	50,654
EDN100/AA	4/1/2013	71632	ELEM TEACHER	Certificated	T04	05	P	A	1.00	52,835	1.00	55,352
EDN100/AA	4/1/2013	69410	SECONDARY TEACHER	Certificated	T07	05	P	A	1.00	64,264	1.00	67,325
EDN100/AA	4/1/2013	65479	ELEM TEACHER	Certificated	T07	05	P	A	1.00	68,177	1.00	71,425
EDN100/AA	4/1/2013	69364	ELEM TEACHER	Certificated	T07	05	P	A	1.00	68,177	1.00	71,425
EDN200/GJ	4/2/2013	57804	OFFICE ASSISTANT III	N	SR08	03	P	A	1.00	32,192	1.00	25,668
EDN300/KO	4/2/2013	74633	PERSONNEL SPECIALIST II	Certificated	E07	06	P	A	1.00	73,191	1.00	81,475
EDN150/FA	4/4/2013	63852	SPEC ED TCHR/PRE-SCHOOL	Certificated	T02	05	P	A	1.00	42,602	1.00	42,509
EDN100/AA	4/4/2013	74485	SECONDARY TEACHER	Certificated	T02	05	T	A	1.00	38,142	1.00	42,509
EDN150/YG	4/6/2013	801200	BEHAVIORAL HLTH SPCLT IV	N	SR22	13	P	A	1.00	42,049	1.00	45,576
EDN150/YC	4/6/2013	58747	BEHAVIORAL HLTH SPCLT IV	N	SR22	13	P	A	1.00	43,761	1.00	47,412
EDN150/YG	4/6/2013	75732	DISTRICT EDUC SPEC II	Certificated	E07	06	P	A	1.00	78,373	1.00	77,069
EDN100/AA	4/10/2013	601362	ELEM TEACHER	Certificated	T02	05	T	A			1.00	43,785
EDN150/FA	4/11/2013	57121	EDUC ASST III	Y	SR12	03	P	A	0.50	13,663	0.50	14,065
EDN150/FA	4/11/2013	72421	GEN EDUC/ARTICLE VI TCHR	Certificated	T02	05	P	A	1.00	41,494	1.00	43,785
EDN150/FA	4/13/2013	74420	SPEC ED TEACHER	Certificated	T04	05	P	A	1.00	49,286	1.00	52,173
EDN100/BS	4/13/2013	76087	ROTC INSTRUCTOR	Certificated	ROTC	05	P	A	1.00	56,878	1.00	74,924
EDN300/KF	4/13/2013	60005	ACCOUNTING DIRECTOR	Certificated	E10	06	P	A	1.00	95,351	1.00	106,105
EDN150/FA	4/16/2013	53164	EDUC ASST III	Y	SR12	03	P	A	0.50	14,193	0.50	14,610
EDN500/PC	4/16/2013	8267	OFFICE ASSISTANT III	N	SR08	03	P	A	1.00	37,506	1.00	25,668
EDN100/AA	4/16/2013	23338	OFFICE ASSISTANT III	N	SR08	03	P	A	1.00	32,424	1.00	32,424
EDN400/MD	4/16/2013	9476	CAFETERIA HELPER	N	BC02	01	P	B	1.00	10,385	1.00	33,228
EDN100/AA	4/18/2013	64427	SECONDARY TEACHER	Certificated	T06	05	P	A	1.00	58,567	1.00	56,431
EDN100/AA	4/20/2013	65659	SECONDARY TEACHER	Certificated	T02	05	P	A	1.00	45,138	1.00	32,222
EDN100/AA	4/20/2013	603391	SECONDARY TEACHER	Certificated	T03	05	T	A			1.00	48,706
EDN100/CB	4/20/2013	59992	PRGM SPCLT V	N	SR24	13	T	W			1.00	51,312
EDN100/AA	4/20/2013	60863	ELEM TEACHER	Certificated	T03	05	P	A	1.00	53,897	1.00	56,464
EDN100/AA	4/21/2013	68358	ELEM TEACHER	Certificated	T07	05	P	A	1.00	66,191	1.00	69,344
EDN150/YC	4/24/2013	58526	BEHAVIORAL HLTH SPCLT III	N	SR20	13	T	A	1.00	43,761	1.00	21,881
EDN150/FA	4/24/2013	47122	EDUC ASST III	Y	SR12	03	P	A	1.00	28,385	1.00	25,030
EDN100/AA	4/25/2013	801547	SCHOOL CUSTODIAN II	N	BC02	01	T	A			0.50	16,614
EDN100/AA	4/27/2013	16764	SCHOOL CUSTODIAN II	N	BC02	01	P	A	1.00	33,228	1.00	33,228
EDN100/AA	4/27/2013	1821	SCHOOL ADM SERVICES ASST II	Certificated	SR14	04	P	A	1.00	32,424	1.00	41,040
EDN150/FA	4/27/2013	602718	GEN EDUC/ARTICLE VI TCHR	Certificated	T02	05	T	A			1.00	42,509
EDN150/NB	4/27/2013	79203	DIST OFF TCHR	Certificated	T03	05	T	N			1.00	45,909
EDN400/OC	4/27/2013	105	PLANNER V	N	SR24	13	P	W			1.00	51,312
EDN100/AA	4/30/2013	29382	SCHOOL HEALTH AIDE	N	SR09	03	P	A	1.00	20,342	1.00	21,133
EDN100/AA	5/1/2013	33304	OFFICE ASSISTANT III	N	SR08	03	P	A	0.50	12,834	0.50	12,834
EDN100/AA	5/1/2013	16493	SCHOOL CUSTODIAN II	N	BC02	01	P	A	0.50	16,614	0.50	16,614

Department of Education
Personnel Separations

Table 15

Prog ID/Org	Separation Date	Position Number	Position Title	Exempt (Y/N)	SR Level	BU Code	T/P	MOF	Budgeted FTE	Budgeted Salary	Actual FTE	Actual Salary
EDN400/OC	5/1/2013	17198	GENERAL LABORER II	N	BC03	01	P	A	1.00	30,682	1.00	17,744
EDN150/FA	5/1/2013	57420	EDUC ASST III	Y	SR12	03	P	A	0.75	20,495	0.75	21,097
EDN150/NB	5/1/2013	802451	EDUC ASST II	Y	SR10	03	T	N			1.00	23,130
EDN150/YG	5/1/2013	801729	EDUC ASST III	Y	SR12	03	T	A			1.00	25,030
EDN100/AA	5/1/2013	801545	OFFICE ASSISTANT III	N	SR08	03	T	A			1.00	25,668
EDN100/AA	5/1/2013	801139	OFFICE ASSISTANT III	N	SR08	03	T	A	0.50	11,844	1.00	25,668
EDN150/FA	5/1/2013	44961	EDUC ASST III	Y	SR12	03	P	A	1.00	28,385	1.00	29,220
EDN100/AA	5/1/2013	16621	SCHOOL CUSTODIAN II	N	BC02	01	P	A	1.00	33,228	1.00	33,228
EDN300/KF	5/1/2013	21917	PRE AUDIT CLERK II	N	SR13	03	P	A	1.00	30,335	1.00	33,756
EDN400/MD	5/1/2013	11543	SCHOOL BAKER	N	BC06	01	P	B	1.00	12,012	1.00	38,436
EDN400/OC	5/1/2013	17076	CARPENTER I	N	BC09	01	P	A	1.00	43,194	1.00	44,544
EDN100/CB	5/1/2013	801024	PRGM SPCLT V	N	SR24	13	T	W			1.00	51,312
EDN150/YC	5/3/2013	800384	SCHOOL PSYCHOLOGIST	Y	SR24	13	P	A	1.00	54,194	1.00	51,312
EDN150/NB	5/4/2013	58598	EDUC ASST II	Y	SR10	03	T	N			1.00	23,130
EDN100/AA	5/4/2013	75259	12-MO STUDENT SVCS COORD	Certificated	T03	05	T	A	1.00	59,338	1.00	45,909
EDN150/FA	5/4/2013	76332	SPEC ED TEACHER	Certificated	T02	05	P	A	1.00	46,011	1.00	49,991
EDN150/FA	5/4/2013	67443	SPEC ED TEACHER	Certificated	T05	05	P	A	1.00	49,765	1.00	61,953
EDN100/AA	5/9/2013	29402	SCHOOL HEALTH AIDE	N	SR09	03	P	A	1.00	20,342	1.00	21,133
EDN150/FA	5/11/2013	58934	EDUC ASST III	Y	SR12	03	P	A	0.50	12,158	0.50	12,515
EDN150/FA	5/11/2013	52632	EDUC ASST III	Y	SR12	03	P	A	0.50	13,124	0.50	13,510
EDN150/YG	5/11/2013	800820	EDUC ASST III	Y	SR12	03	P	A	1.00	25,053	1.00	26,010
EDN150/YG	5/11/2013	800946	BEHAVIORAL HLTH SPCLT IV	N	SR22	13	P	A	1.00	49,223	1.00	47,412
EDN150/YC	5/11/2013	58421	BEHAVIORAL HLTH SPCLT IV	N	SR22	13	T	A	1.00	45,533	1.00	49,332
EDN200/GN	5/16/2013	33118	ACCOUNT CLERK III	N	SR11	03	P	A	0.50	14,176	0.50	14,418
EDN100/AA	5/16/2013	801380	SCHOOL CUSTODIAN II	N	BC02	01	T	A	0.50	16,614	0.50	16,614
EDN150/FA	5/17/2013	800062	EDUC ASST III	Y	SR12	03	T	A	1.00	27,326	1.00	25,030
EDN150/FA	5/17/2013	72565	SPEC ED TEACHER	Certificated	T02	05	P	A	1.00	48,595	1.00	42,509
EDN400/MD	5/18/2013	57873	CAFETERIA HELPER	N	BC02	01	T	B			0.50	16,614
EDN400/MD	5/18/2013	52990	CAFETERIA HELPER	N	BC02	01	T	B	0.50	5,192	0.50	16,614
EDN400/OC	5/21/2013	34313	ENGINEER III	N	SR22	13	P	A	1.00	63,026	1.00	23,663
EDN150/FA	5/24/2013	73916	SPEC ED TEACHER	Certificated	T04	05	P	A	1.00	46,011	1.00	50,654
EDN150/FA	5/25/2013	58933	EDUC ASST I	Y	SR08	03	P	A	0.75	18,237	0.75	9,995
EDN100/AA	5/25/2013	55911	OFFICE ASSISTANT III	N	SR08	03	P	A	0.50	12,834	0.50	12,834
EDN100/AA	5/25/2013	802477	DP USER SUPPORT TECH II	N	SR15	03	T	A			1.00	17,528
EDN150/YC	5/25/2013	59636	BEHAVIORAL HLTH SPCLT III	N	SR20	13	T	A	1.00	42,066	1.00	21,881
EDN100/AA	5/25/2013	65743	LIBRARIAN	Certificated	T04	05	T	A	0.50	33,067	0.50	23,873
EDN100/AA	5/25/2013	53283	EDUC ASST III	Y	SR12	03	P	A	1.00	26,131	1.00	25,030
EDN150/FA	5/25/2013	53025	EDUC ASST III	Y	SR12	03	P	A	1.00	26,248	1.00	27,020
EDN100/AA	5/25/2013	64906	SECONDARY TEACHER	Certificated	T02	05	P	A	1.00	61,821	1.00	32,222
EDN100/AA	5/25/2013	68471	SECONDARY TEACHER	Certificated	T02	05	P	A	1.00	61,567	1.00	32,222
EDN100/AA	5/25/2013	61427	ELEM TEACHER	Certificated	T02	05	P	A	1.00	41,794	1.00	32,222
EDN150/FA	5/25/2013	603502	GEN EDUC/ARTICLE VI TCHR	Certificated	T02	05	T	A			1.00	42,509
EDN100/AA	5/25/2013	600641	ELEM TEACHER	Certificated	T03	05	T	A			1.00	45,909
EDN100/AA	5/25/2013	602665	ELEM TEACHER	Certificated	T03	05	T	A			1.00	45,909
EDN150/FA	5/25/2013	603702	SPEC ED TEACHER	Certificated	T03	05	T	A			1.00	45,909

<u>Prog ID/Org</u>	<u>Separation Date</u>	<u>Position Number</u>	<u>Position Title</u>	<u>Exempt (Y/N)</u>	<u>SR Level</u>	<u>BU Code</u>	<u>T/P</u>	<u>MOF</u>	<u>Budgeted FTE</u>	<u>Budgeted Salary</u>	<u>Actual FTE</u>	<u>Actual Salary</u>
EDN100/AA	5/25/2013	602968	ELEM TEACHER	Certificated	T03	05	T	A			1.00	45,909
EDN100/AA	5/25/2013	66993	SECONDARY TEACHER	Certificated	T04	05	P	A	1.00	48,351	1.00	50,654
EDN100/AA	5/25/2013	60211	SECONDARY TEACHER	Certificated	T05	05	P	A	1.00	51,268	1.00	52,680
EDN100/AA	5/28/2013	61256	ELEM TEACHER	Certificated	T02	05	P	A	1.00	62,391	1.00	42,509
EDN100/AA	5/28/2013	61354	ELEM TEACHER	Certificated	T02	05	P	A	1.00	68,177	1.00	42,509
EDN100/AA	5/28/2013	603595	ELEM TEACHER	Certificated	T02	05	T	A			1.00	42,509
EDN100/AA	5/28/2013	60274	ELEM TEACHER	Certificated	T02	05	P	A	1.00	48,351	1.00	42,509
EDN100/AA	5/28/2013	62601	ELEM TEACHER	Certificated	T02	05	P	A	1.00	52,279	1.00	42,509
EDN100/AA	5/28/2013	602426	ELEM TEACHER	Certificated	T02	05	T	A			1.00	42,509
EDN150/FA	5/28/2013	72572	SPEC ED TEACHER	Certificated	T02	05	P	A	1.00	48,813	1.00	42,509
EDN150/FA	5/28/2013	603229	SPEC ED TEACHER	Certificated	T02	05	T	A			1.00	42,509
EDN150/FA	5/28/2013	75942	GEN EDUC/ARTICLE VI TCHR	Certificated	T03	05	P	A	1.00	47,541	1.00	45,909
EDN150/FA	5/28/2013	60662	SPEC ED TEACHER	Certificated	T03	05	P	A	1.00	30,439	1.00	45,909
EDN100/AA	5/28/2013	61387	ELEM TEACHER	Certificated	T03	05	P	A	1.00	64,264	1.00	45,909
EDN100/AA	5/28/2013	61946	SECONDARY TEACHER	Certificated	T03	05	P	A	1.00	64,264	1.00	45,909
EDN100/AA	5/28/2013	73879	SECONDARY TEACHER	Certificated	T03	05	P	A	1.00	48,351	1.00	45,909
EDN150/FA	5/28/2013	61476	SPEC ED TEACHER	Certificated	T03	05	P	A	1.00	43,369	1.00	45,909
EDN150/FA	5/28/2013	62188	SPEC ED TEACHER	Certificated	T03	05	P	A	1.00	44,671	1.00	47,287
EDN150/FA	5/28/2013	62427	GEN EDUC/ARTICLE VI TCHR	Certificated	T07	05	P	A	1.00	52,396	1.00	54,741
EDN150/FA	5/29/2013	57249	EDUC ASST III	Y	SR12	03	P	A	0.50	14,781	0.50	15,215
EDN100/AA	5/29/2013	18563	SCHOOL CUSTODIAN II	N	BC02	01	P	A	0.50	16,614	0.50	16,614
EDN400/MD	5/29/2013	58692	CAFETERIA HELPER	N	BC02	01	T	B	0.50	5,192	0.50	16,614
EDN150/FA	5/29/2013	57357	EDUC ASST II	Y	SR10	03	T	A	0.75	18,237	0.75	17,348
EDN150/FA	5/29/2013	801896	EDUC ASST III	Y	SR12	03	T	A			0.75	18,773
EDN150/YG	5/29/2013	800836	EDUC ASST II	Y	SR10	03	P	A	1.00	24,109	1.00	23,130
EDN150/NB	5/29/2013	800361	EDUC ASST II	Y	SR10	03	T	N			1.00	23,130
EDN100/AA	5/29/2013	801449	EDUC ASST II	Y	SR10	03	P	A			1.00	23,130
EDN150/YG	5/29/2013	801703	EDUC ASST III	Y	SR12	03	T	A			1.00	25,030
EDN150/NB	5/29/2013	802631	EDUC ASST III	Y	SR12	03	T	N			1.00	25,030
EDN100/AA	5/29/2013	61104	ELEM TEACHER	Certificated	T07	05	T	A	0.50	29,405	0.50	30,806
EDN150/FA	5/29/2013	66643	SPEC ED TEACHER	Certificated	T02	05	P	A	1.00	44,671	1.00	32,222
EDN150/FA	5/29/2013	62415	SPEC ED TEACHER	Certificated	T02	05	P	A	1.00	40,157	1.00	42,509
EDN100/AA	5/29/2013	601378	SECONDARY TEACHER	Certificated	T02	05	T	A			1.00	42,509
EDN150/FA	5/29/2013	73878	SPEC ED TEACHER	Certificated	T02	05	P	A	1.00	44,671	1.00	42,509
EDN150/FA	5/29/2013	66868	SPEC ED TEACHER	Certificated	T02	05	P	A	1.00	40,157	1.00	42,509
EDN150/FA	5/29/2013	74872	GEN EDUC/ARTICLE VI TCHR	Certificated	T02	05	P	A	1.00	44,813	1.00	42,509
EDN100/AA	5/29/2013	72658	ELEM TEACHER	Certificated	T02	05	P	A	1.00	74,436	1.00	42,509
EDN150/FA	5/29/2013	68341	GEN EDUC/ARTICLE VI TCHR	Certificated	T02	05	P	A	1.00	47,366	1.00	42,509
EDN100/AA	5/29/2013	74666	ELEM TEACHER	Certificated	T02	05	T	A	1.00	47,398	1.00	42,509
EDN150/FA	5/29/2013	73724	SPEC ED TEACHER	Certificated	T02	05	P	A	1.00	40,157	1.00	42,509
EDN100/AA	5/29/2013	600144	SECONDARY TEACHER	Certificated	T02	05	T	A			1.00	42,509
EDN100/AA	5/29/2013	66094	ELEM TEACHER	Certificated	T03	05	P	A	1.00	43,822	1.00	45,909
EDN100/AA	5/29/2013	67814	SECONDARY TEACHER	Certificated	T03	05	P	A	1.00	46,120	1.00	45,909
EDN100/AA	5/29/2013	601437	SECONDARY TEACHER	Certificated	T03	05	T	A			1.00	45,909
EDN150/FA	5/29/2013	76061	SPEC ED TEACHER	Certificated	T03	05	P	A	1.00	48,813	1.00	45,909

Prog ID/Org	Separation Date	Position Number	Position Title	Exempt (Y/N)	SR Level	BU Code	T/P	MOF	Budgeted FTE	Budgeted Salary	Actual FTE	Actual Salary
EDN100/AA	5/29/2013	68630	SECONDARY TEACHER	Certificated	T03	05	P	A	1.00	38,142	1.00	45,909
EDN100/AA	5/29/2013	66861	SECONDARY TEACHER	Certificated	T03	05	P	A	1.00	43,048	1.00	45,909
EDN100/AA	5/29/2013	603626	ELEM TEACHER	Certificated	T03	05	T	A			1.00	45,909
EDN100/AA	5/29/2013	64127	SECONDARY TEACHER	Certificated	T03	05	P	A	1.00	43,822	1.00	45,909
EDN100/AA	5/29/2013	68316	SECONDARY TEACHER	Certificated	T03	05	P	A	1.00	46,492	1.00	45,909
EDN150/FA	5/29/2013	75590	SPEC ED TEACHER	Certificated	T03	05	T	A	1.00	54,860	1.00	45,909
EDN100/AA	5/29/2013	67476	ELEM TEACHER	Certificated	T03	05	T	A	1.00	55,482	1.00	45,909
EDN100/AA	5/29/2013	66632	SECONDARY TEACHER	Certificated	T03	05	P	A	1.00	43,822	1.00	45,909
EDN150/FA	5/29/2013	602486	GEN EDUC/ARTICLE VI TCHR	Certificated	T03	05	T	A			1.00	47,287
EDN150/FA	5/29/2013	64394	GEN EDUC/ARTICLE VI TCHR	Certificated	T03	05	P	A	1.00	40,285	1.00	47,287
EDN100/AA	5/29/2013	60326	SECONDARY TEACHER	Certificated	T04	05	P	A	1.00	43,822	1.00	47,746
EDN150/NB	5/29/2013	79613	DIST OFF TCHR	Certificated	T07	05	T	N			1.00	58,074
EDN150/FA	5/31/2013	33259	EDUC ASST III	Y	SR12	03	P	A	1.00	28,385	1.00	29,220
EDN100/DB	5/31/2013	600350	ELEM TEACHER	Certificated	T02	05	T	N			1.00	49,991
EDN100/AA	5/31/2013	67464	ELEM TEACHER	Certificated	T02	05	P	A	1.00	43,048	1.00	53,036
EDN100/AA	5/31/2013	71257	ELEM TEACHER	Certificated	T03	05	P	A	1.00	45,138	1.00	53,990
EDN100/AA	5/31/2013	66548	ELEM TEACHER	Certificated	T03	05	P	A	1.00	53,348	1.00	53,990
EDN100/DB	5/31/2013	79831	ELEM TEACHER	Certificated	T03	05	T	N			1.00	55,611
EDN400/MD	6/1/2013	57926	CAFETERIA HELPER	N	BC02	01	P	B	0.50	5,192	0.50	16,614
EDN400/MD	6/1/2013	59907	CAFETERIA HELPER	N	BC02	01	T	B			0.50	16,614
EDN400/OD	6/1/2013	47012	SCHOOL CUSTODIAN II	N	BC02	01	P	A	0.50	14,922	0.50	16,614
EDN100/AA	6/1/2013	29387	SCHOOL HEALTH AIDE	N	SR09	03	P	A	1.00	19,575	1.00	20,336
EDN150/FA	6/1/2013	800048	EDUC ASST III	Y	SR12	03	P	A	0.75	20,495	0.75	21,097
EDN150/FA	6/1/2013	53120	EDUC ASST III	Y	SR12	03	P	A	0.75	20,495	0.75	21,097
EDN100/AA	6/1/2013	29431	SCHOOL HEALTH AIDE	N	SR09	03	P	A	1.00	20,342	1.00	21,133
EDN100/AA	6/1/2013	30586	SCHOOL SECURITY ATTENDANT	N	SR07	03	P	A	1.00	24,148	1.00	23,130
EDN150/FA	6/1/2013	31339	EDUC ASST III	Y	SR12	03	P	A	0.75	23,970	0.75	24,675
EDN150/SA	6/1/2013	30498	COMMUNICATION AIDE	Y	SR12	03	P	A	0.75	23,766	0.75	24,675
EDN150/SA	6/1/2013	34624	COMMUNICATION AIDE	Y	SR12	03	P	A	0.75	24,705	0.75	25,650
EDN100/AA	6/1/2013	29313	SCHOOL HEALTH AIDE	N	SR09	03	P	A	1.00	25,730	1.00	26,731
EDN400/OC	6/1/2013	17063	OFFICE ASSISTANT IV	N	SR10	03	P	A	1.00	25,897	1.00	27,756
EDN150/FA	6/1/2013	56946	EDUC ASST III	Y	SR12	03	P	A	1.00	28,385	1.00	29,220
EDN100/AA	6/1/2013	33202	SCHOOL SECURITY ATTENDANT	N	SR07	03	P	A	1.00	30,506	1.00	29,220
EDN100/AA	6/1/2013	33052	SCHOOL SECURITY ATTENDANT	N	SR07	03	P	A	1.00	30,506	1.00	29,220
EDN150/FA	6/1/2013	37675	EDUC ASST III	Y	SR12	03	P	A	1.00	28,385	1.00	29,220
EDN100/AA	6/1/2013	38884	OFFICE ASSISTANT III	N	SR08	03	P	A	1.00	30,036	1.00	30,036
EDN100/AA	6/1/2013	55898	OFFICE ASSISTANT III	N	SR08	03	P	A	0.50	15,018	1.00	30,036
EDN150/FA	6/1/2013	45193	EDUC ASST III	Y	SR12	03	P	A	1.00	29,561	1.00	30,430
EDN150/FA	6/1/2013	53257	EDUC ASST III	Y	SR12	03	P	A	1.00	33,032	1.00	31,640
EDN150/FA	6/1/2013	41342	EDUC ASST III	Y	SR12	03	P	A	1.00	31,959	1.00	32,900
EDN400/MD	6/1/2013	34953	CAFETERIA HELPER	N	BC02	01	P	B	1.00	10,385	1.00	33,228
EDN100/AA	6/1/2013	29288	SCHOOL CUSTODIAN II	N	BC02	01	P	A	1.00	33,228	1.00	33,228
EDN400/MD	6/1/2013	9347	CAFETERIA HELPER	N	BC02	01	P	B	1.00	10,385	1.00	33,228
EDN100/AA	6/1/2013	54935	SCHOOL CUSTODIAN II	N	BC02	01	P	A	1.00	33,228	1.00	33,228
EDN150/FA	6/1/2013	30984	EDUC ASST III	Y	SR12	03	P	A	1.00	33,223	1.00	34,200

<u>Prog ID/Org</u>	<u>Separation Date</u>	<u>Position Number</u>	<u>Position Title</u>	<u>Exempt (Y/N)</u>	<u>SR Level</u>	<u>BU Code</u>	<u>T/P</u>	<u>MOF</u>	<u>Budgeted FTE</u>	<u>Budgeted Salary</u>	<u>Actual FTE</u>	<u>Actual Salary</u>
EDN150/FA	6/1/2013	30042	EDUC ASST III	Y	SR12	03	P	A	1.00	33,223	1.00	34,200
EDN400/OC	6/1/2013	18831	TRACTOR OPERATOR	N	BC04	01	P	A	1.00	33,905	1.00	35,544
EDN400/MD	6/1/2013	54718	SCHOOL BAKER	N	BC06	01	P	B			1.00	38,436
EDN100/AA	6/1/2013	63048	ELEM TEACHER	Certificated	T03	05	P	A	1.00	53,866	1.00	45,909
EDN100/AA	6/1/2013	68149	ELEM TEACHER	Certificated	T03	05	P	A	1.00	43,822	1.00	45,909
EDN150/FA	6/1/2013	603373	GEN EDUC/ARTICLE VI TCHR	Certificated	T03	05	T	A			1.00	45,909
EDN100/AA	6/1/2013	603583	ELEM TEACHER	Certificated	T03	05	T	A			1.00	45,909
EDN100/AA	6/1/2013	60322	SECONDARY TEACHER	Certificated	T03	05	P	A	1.00	30,757	1.00	45,909
EDN100/AA	6/1/2013	64153	ELEM TEACHER	Certificated	T03	05	P	A	1.00	43,822	1.00	45,909
EDN150/FA	6/1/2013	60099	SPEC ED TEACHER	Certificated	T03	05	P	A	1.00	47,851	1.00	45,909
EDN100/AA	6/1/2013	64962	SECONDARY TEACHER	Certificated	T02	05	P	A	1.00	44,339	1.00	46,451
EDN150/SA	6/1/2013	30715	SCH BASED OCC THRPY ASST (FP)	N	HE10	10	P	A	1.00	41,613	1.00	46,548
EDN150/SA	6/1/2013	30710	SCH BASED OCC THRPY ASST (FP)	N	HE10	10	P	A	1.00	41,613	1.00	46,548
EDN100/AA	6/1/2013	600053	ELEM TEACHER	Certificated	T03	05	T	A			1.00	47,287
EDN150/FA	6/1/2013	69243	SPEC ED TEACHER	Certificated	T04	05	P	A	1.00	43,369	1.00	47,746
EDN150/FA	6/1/2013	63636	SPEC ED TEACHER	Certificated	T03	05	P	A	1.00	46,011	1.00	48,706
EDN150/FA	6/1/2013	71025	SPEC ED TEACHER	Certificated	T03	05	P	A	1.00	46,011	1.00	48,706
EDN100/AA	6/1/2013	73710	SECONDARY TEACHER	Certificated	T03	05	T	A	1.00	46,492	1.00	48,706
EDN150/FA	6/1/2013	68512	SPEC ED TEACHER	Certificated	T03	05	P	A	1.00	46,011	1.00	48,706
EDN100/AA	6/1/2013	69846	SECONDARY TEACHER	Certificated	T03	05	P	A	1.00	47,886	1.00	50,167
EDN150/FA	6/1/2013	66733	GEN EDUC/ARTICLE VI TCHR	Certificated	T04	05	P	A	1.00	52,396	1.00	50,654
EDN100/AA	6/1/2013	64736	ELEM TEACHER	Certificated	T04	05	P	A	1.00	51,426	1.00	50,654
EDN400/MC	6/1/2013	801539	PRGM SPCLT V	N	SR24	13	T	N			1.00	51,312
EDN100/AA	6/1/2013	68111	SECONDARY TEACHER	Certificated	T02	05	P	A	1.00	49,904	1.00	52,280
EDN100/AA	6/1/2013	67147	COUNSELOR	Certificated	T05	05	P	A	1.00	53,483	1.00	52,680
EDN150/YC	6/1/2013	58512	BEHAVIORAL HLTH SPCLT IV	N	SR22	13	P	A	1.00	49,243	1.00	53,352
EDN100/AA	6/1/2013	69856	ELEM TEACHER	Certificated	T04	05	P	A	1.00	51,296	1.00	53,739
EDN100/AA	6/1/2013	60234	SECONDARY TEACHER	Certificated	T04	05	P	A	1.00	51,296	1.00	53,739
EDN150/FB	6/1/2013	75020	SPECIAL SCH TEACHER	Certificated	T03	05	P	A	1.00	39,795	1.00	53,990
EDN150/FA	6/1/2013	75945	GEN EDUC/ARTICLE VI TCHR	Certificated	T03	05	P	A	1.00	40,285	1.00	53,990
EDN100/AA	6/1/2013	63752	SECONDARY TEACHER	Certificated	T03	05	P	A	1.00	45,138	1.00	53,990
EDN150/FA	6/1/2013	73942	SPEC ED TEACHER	Certificated	T03	05	P	A			1.00	53,990
EDN100/AA	6/1/2013	600246	ELEM TEACHER	Certificated	T05	05	T	A			1.00	54,260
EDN100/AA	6/1/2013	71051	SECONDARY TEACHER	Certificated	T05	05	P	A	1.00	51,793	1.00	54,260
EDN100/AA	6/1/2013	69488	ELEM TEACHER	Certificated	T05	05	P	A	1.00	52,514	1.00	55,888
EDN150/FA	6/1/2013	69206	SPEC ED TEACHER	Certificated	T02	05	P	A	1.00	53,967	1.00	57,129
EDN100/AA	6/1/2013	60167	ELEM TEACHER	Certificated	T05	05	P	A	1.00	54,948	1.00	57,565
EDN150/SA	6/1/2013	54420	SOCIAL WORKER IV	N	SR22	13	P	A	1.00	54,744	1.00	57,708
EDN100/AA	6/1/2013	64028	ELEM TEACHER	Certificated	T07	05	P	A	1.00	56,651	1.00	58,074
EDN150/FA	6/1/2013	67853	SPEC ED TEACHER	Certificated	T06	05	P	A	1.00	54,908	1.00	58,124
EDN100/AA	6/1/2013	71222	ELEM TEACHER	Certificated	T06	05	P	A	1.00	55,482	1.00	58,124
EDN100/AA	6/1/2013	65022	ELEM TEACHER	Certificated	T03	05	P	A	1.00	56,495	1.00	58,157
EDN100/AA	6/1/2013	601631	SECONDARY TEACHER	Certificated	T04	05	T	A			1.00	58,722
EDN150/FA	6/1/2013	60525	SPEC ED TCHR/PRE-SCHOOL	Certificated	T07	05	P	A	1.00	56,507	1.00	59,818
EDN100/AA	6/1/2013	73005	COUNSELOR	Certificated	T07	05	P	A	1.00	60,729	1.00	59,818

Department of Education
Personnel Separations

Table 15

<u>Prog ID/Org</u>	<u>Separation Date</u>	<u>Position Number</u>	<u>Position Title</u>	<u>Exempt (Y/N)</u>	<u>SR Level</u>	<u>BU Code</u>	<u>T/P</u>	<u>MOF</u>	<u>Budgeted FTE</u>	<u>Budgeted Salary</u>	<u>Actual FTE</u>	<u>Actual Salary</u>
EDN100/AA	6/1/2013	61661	SECONDARY TEACHER	Certificated	T07	05	P	A	1.00	57,098	1.00	59,818
EDN150/FA	6/1/2013	76049	SPEC ED TEACHER	Certificated	T07	05	P	A	1.00	56,507	1.00	59,818
EDN100/AA	6/1/2013	67198	SECONDARY TEACHER	Certificated	T06	05	P	A	1.00	57,145	1.00	59,867
EDN100/AA	6/1/2013	62624	ELEM TEACHER	Certificated	T04	05	P	A	1.00	57,734	1.00	60,483
EDN100/AA	6/1/2013	66168	SECONDARY TEACHER	Certificated	T04	05	P	A	1.00	57,734	1.00	60,483
EDN100/AA	6/1/2013	64703	ELEM TEACHER	Certificated	T05	05	P	A	1.00	58,295	1.00	61,071
EDN100/AA	6/1/2013	65702	ELEM TEACHER	Certificated	T05	05	P	A	1.00	58,295	1.00	61,071
EDN100/DB	6/1/2013	79235	ELEM TEACHER	Certificated	T02	05	T	N			1.00	61,482
EDN100/AA	6/1/2013	64903	SECONDARY TEACHER	Certificated	T07	05	P	A	1.00	58,810	1.00	61,611
EDN100/AA	6/1/2013	71821	ELEM TEACHER	Certificated	T07	05	P	A	1.00	59,793	1.00	61,611
EDN100/AA	6/1/2013	66722	SECONDARY TEACHER	Certificated	T07	05	P	A	1.00	58,810	1.00	61,611
EDN100/AA	6/1/2013	68942	ELEM TEACHER	Certificated	T05	05	P	A	1.00	61,025	1.00	62,903
EDN100/AA	6/1/2013	64105	SECONDARY TEACHER	Certificated	T07	05	P	A	1.00	60,575	1.00	63,460
EDN100/AA	6/1/2013	62208	COUNSELOR	Certificated	T07	05	P	A	1.00	64,427	1.00	63,460
EDN150/FA	6/1/2013	67805	SPEC ED TEACHER	Certificated	T07	05	P	A	1.00	60,921	1.00	63,460
EDN100/AA	6/1/2013	61208	ELEM TEACHER	Certificated	T07	05	P	A	1.00	61,557	1.00	63,460
EDN200/GN	6/1/2013	72564	COMPLEX AREA TEACHER	Certificated	T07	05	P	A	1.00	58,523	1.00	63,460
EDN100/AA	6/1/2013	71401	VICE PRINCIPAL I	Certificated	E03	06	P	A	1.00	74,523	1.00	63,568
EDN150/SA	6/1/2013	33046	SPEECH PATHOLOGIST IV	Y	SR22	13	P	A	1.00	63,874	1.00	64,920
EDN150/SA	6/1/2013	30429	SPEECH PATHOLOGIST IV	Y	SR22	13	P	A	1.00	63,874	1.00	64,920
EDN100/AA	6/1/2013	61755	ELEM TEACHER	Certificated	T07	05	P	A	1.00	63,374	1.00	65,363
EDN100/AA	6/1/2013	63367	COUNSELOR	Certificated	T07	05	P	A	1.00	66,359	1.00	65,363
EDN100/AA	6/1/2013	60187	ELEM TEACHER	Certificated	T06	05	P	A	1.00	63,428	1.00	65,419
EDN100/AA	6/1/2013	63359	ELEM TEACHER	Certificated	T06	05	P	A	1.00	63,428	1.00	65,419
EDN100/AA	6/1/2013	65299	SECONDARY TEACHER	Certificated	T06	05	P	A	1.00	64,264	1.00	65,419
EDN100/AA	6/1/2013	603103	ELEM TEACHER	Certificated	T06	05	T	A			1.00	66,364
EDN100/AA	6/1/2013	60175	ELEM TEACHER	Certificated	T07	05	P	A	1.00	64,264	1.00	67,325
EDN100/AA	6/1/2013	69237	ELEM TEACHER	Certificated	T07	05	P	A	1.00	65,247	1.00	67,325
EDN100/AA	6/1/2013	61268	ELEM TEACHER	Certificated	T07	05	P	A	1.00	65,247	1.00	67,325
EDN100/DB	6/1/2013	603565	DIST OFF TCHR	Certificated	T07	05	T	N			1.00	67,325
EDN100/AA	6/1/2013	72537	ELEM TEACHER	Certificated	T06	05	P	A	1.00	64,318	1.00	67,381
EDN150/FA	6/1/2013	60330	GEN EDUC/ARTICLE VI TCHR	Certificated	T06	05	P	A	1.00	63,855	1.00	67,381
EDN100/AA	6/1/2013	63260	ELEM TEACHER	Certificated	T03	05	P	A	1.00	55,513	1.00	68,393
EDN100/AA	6/1/2013	67035	SECONDARY TEACHER	Certificated	T04	05	P	A	1.00	56,053	1.00	69,058
EDN100/AA	6/1/2013	66998	SECONDARY TEACHER	Certificated	T07	05	P	A	1.00	66,191	1.00	69,344
EDN100/AA	6/1/2013	61050	ELEM TEACHER	Certificated	T07	05	P	A	1.00	67,408	1.00	69,344
EDN100/AA	6/1/2013	71106	ELEM TEACHER	Certificated	T07	05	P	A	1.00	66,191	1.00	69,344
EDN200/GN	6/1/2013	76382	COMPLEX AREA TEACHER	Certificated	T07	05	T	A	1.00	63,949	1.00	69,344
EDN150/FA	6/1/2013	61392	SPEC ED TEACHER	Certificated	T07	05	P	A	1.00	65,506	1.00	69,344
EDN150/FA	6/1/2013	66306	SPEC ED TCHR/PRE-SCHOOL	Certificated	T07	05	P	A	1.00	65,506	1.00	69,344
EDN100/AA	6/1/2013	73453	ELEM TEACHER	Certificated	T07	05	P	A	1.00	70,400	1.00	69,344
EDN100/AA	6/1/2013	72290	SECONDARY TEACHER	Certificated	T07	05	P	A	1.00	68,295	1.00	69,344
EDN100/AA	6/1/2013	68795	ELEM TEACHER	Certificated	T07	05	P	A	1.00	66,191	1.00	69,344
EDN100/AA	6/1/2013	66509	ELEM TEACHER	Certificated	T07	05	P	A	1.00	66,191	1.00	69,344
EDN100/AA	6/1/2013	63415	ELEM TEACHER	Certificated	T07	05	P	A	1.00	67,408	1.00	69,344

Department of Education
Personnel Separations

Table 15

<u>Prog ID/Org</u>	<u>Separation Date</u>	<u>Position Number</u>	<u>Position Title</u>	<u>Exempt (Y/N)</u>	<u>SR Level</u>	<u>BU Code</u>	<u>T/P</u>	<u>MOF</u>	<u>Budgeted FTE</u>	<u>Budgeted Salary</u>	<u>Actual FTE</u>	<u>Actual Salary</u>
EDN100/AA	6/1/2013	71092	ELEM TEACHER	Certificated	T07	05	T	A	1.00	67,173	1.00	69,344
EDN300/KO	6/1/2013	73533	12-MO STATE OFF TCHR	Certificated	T07	05	P	A	1.00	76,052	1.00	69,344
EDN100/AA	6/1/2013	60594	ELEM TEACHER	Certificated	T07	05	P	A	1.00	70,400	1.00	69,344
EDN100/AA	6/1/2013	62491	SECONDARY TEACHER	Certificated	T06	05	P	A	1.00	66,248	1.00	69,404
EDN100/AA	6/1/2013	62873	ELEM TEACHER	Certificated	T05	05	P	A	1.00	67,521	1.00	70,737
EDN100/AA	6/1/2013	63619	ELEM TEACHER	Certificated	T04	05	T	A	1.00	46,492	1.00	71,129
EDN100/AA	6/1/2013	67997	ELEM TEACHER	Certificated	T04	05	P	A	1.00	58,716	1.00	71,129
EDN100/AA	6/1/2013	65168	ELEM TEACHER	Certificated	T07	05	P	A	1.00	68,177	1.00	71,425
EDN150/NB	6/1/2013	79261	DIST OFF TCHR	Certificated	T07	05	T	N			1.00	71,425
EDN100/AA	6/1/2013	76253	ELEM TEACHER	Certificated	T07	05	P	A	1.00	68,177	1.00	71,425
EDN100/AA	6/1/2013	72346	ELEM TEACHER	Certificated	T07	05	P	A	1.00	68,177	1.00	71,425
EDN100/AA	6/1/2013	69367	ELEM TEACHER	Certificated	T07	05	P	A	1.00	68,177	1.00	71,425
EDN100/AA	6/1/2013	61241	SECONDARY TEACHER	Certificated	T07	05	P	A	1.00	72,513	1.00	71,425
EDN100/AA	6/1/2013	64045	LIBRARIAN	Certificated	T07	05	P	A	1.00	73,808	1.00	71,425
EDN100/AA	6/1/2013	76334	COMPLEX AREA TEACHER	Certificated	T07	05	T	A	0.50	36,257	1.00	71,425
EDN100/AA	6/1/2013	63918	ELEM TEACHER	Certificated	T07	05	P	A	1.00	68,177	1.00	71,425
EDN100/AA	6/1/2013	71612	ELEM TEACHER	Certificated	T07	05	P	A	1.00	58,810	1.00	72,455
EDN150/FA	6/1/2013	65493	GEN EDUC/ARTICLE VI TCHR	Certificated	T07	05	P	A	1.00	58,387	1.00	72,455
EDN100/AA	6/1/2013	65032	ELEM TEACHER	Certificated	T07	05	P	A	1.00	58,810	1.00	72,455
EDN100/AA	6/1/2013	74370	COUNSELOR	Certificated	T06	05	P	A	1.00	49,448	1.00	72,517
EDN150/FA	6/1/2013	72133	SPEC ED TEACHER	Certificated	T07	05	P	A	1.00	69,496	1.00	73,567
EDN100/AA	6/1/2013	66900	ELEM TEACHER	Certificated	T07	05	P	A	1.00	70,222	1.00	73,567
EDN150/FA	6/1/2013	76006	SPEC ED TEACHER	Certificated	T07	05	P	A	1.00	69,496	1.00	73,567
EDN150/FA	6/1/2013	64073	SPEC ED TEACHER	Certificated	T07	05	P	A	1.00	70,701	1.00	73,567
EDN150/FA	6/1/2013	71290	SPEC ED TEACHER	Certificated	T07	05	P	A	1.00	69,496	1.00	73,567
EDN100/AA	6/1/2013	68297	SECONDARY TEACHER	Certificated	T06	05	P	A	1.00	70,222	1.00	73,567
EDN100/BB	6/1/2013	64090	SECONDARY TEACHER	Certificated	T07	05	P	A	1.00	69,981	1.00	73,567
EDN100/AA	6/1/2013	72017	SECONDARY TEACHER	Certificated	T07	05	P	A	1.00	70,222	1.00	73,567
EDN150/FA	6/1/2013	73278	SPEC ED TCHR/PRE-SCHOOL	Certificated	T07	05	P	A	1.00	69,496	1.00	73,567
EDN100/AA	6/1/2013	74272	SECONDARY TEACHER	Certificated	T06	05	P	A	1.00	70,222	1.00	73,567
EDN100/AA	6/1/2013	600450	VICE PRINCIPAL I	Certificated	E03	06	T	A			1.00	75,108
EDN100/AA	6/1/2013	62180	SECONDARY TEACHER	Certificated	T07	05	P	A	1.00	76,199	1.00	77,982
EDN100/AA	6/1/2013	65146	ELEM TEACHER	Certificated	T07	05	P	A	1.00	74,436	1.00	77,982
EDN100/AA	6/1/2013	64401	ELEM TEACHER	Certificated	T07	05	P	A	1.00	74,436	1.00	77,982
EDN100/AA	6/1/2013	61111	SECONDARY TEACHER	Certificated	T07	05	P	A	1.00	74,436	1.00	77,982
EDN100/AA	6/1/2013	66880	ELEM TEACHER	Certificated	T07	05	P	A	1.00	74,436	1.00	77,982
EDN100/AA	6/1/2013	68616	SECONDARY TEACHER	Certificated	T07	05	P	A	1.00	74,436	1.00	77,982
EDN100/AA	6/1/2013	63504	SECONDARY TEACHER	Certificated	T07	05	P	A	1.00	30,757	1.00	77,982
EDN100/AA	6/1/2013	63812	ELEM TEACHER	Certificated	T07	05	P	A	1.00	75,654	1.00	77,982
EDN100/AA	6/1/2013	66919	LIBRARIAN	Certificated	T07	05	P	A	1.00	80,465	1.00	77,982
EDN100/DB	6/1/2013	79145	DIST OFF TCHR	Certificated	T07	05	T	N			1.00	77,982
EDN100/AA	6/1/2013	60975	COUNSELOR/ALIENATION	Certificated	T07	05	P	A	1.00	79,170	1.00	77,982
EDN100/AA	6/1/2013	67058	SECONDARY TEACHER	Certificated	T07	05	P	A	1.00	74,436	1.00	77,982
EDN100/AA	6/1/2013	67489	SECONDARY TEACHER	Certificated	T07	05	P	A	1.00	74,436	1.00	77,982
EDN100/AA	6/1/2013	601449	10-MO STUDENT SVCS COORD	Certificated	T07	05	T	A			1.00	77,982

Department of Education
Personnel Separations

Table 15

Prog ID/Org	Separation Date	Position Number	Position Title	Exempt (Y/N)	SR Level	BU Code	T/P	MOF	Budgeted FTE	Budgeted Salary	Actual FTE	Actual Salary
EDN100/AA	6/1/2013	62754	ELEM TEACHER	Certificated	T07	05	P	A	1.00	75,654	1.00	77,982
EDN150/FA	6/1/2013	69361	SPEC ED TEACHER	Certificated	T07	05	P	A	1.00	74,639	1.00	77,982
EDN100/AA	6/1/2013	62028	SECONDARY TEACHER	Certificated	T07	05	P	A	1.00	74,436	1.00	77,982
EDN100/AA	6/1/2013	65679	ELEM TEACHER	Certificated	T07	05	P	A	1.00	75,419	1.00	77,982
EDN100/AA	6/1/2013	68123	ELEM TEACHER	Certificated	T07	05	P	A	1.00	74,436	1.00	77,982
EDN100/AA	6/1/2013	66827	SECONDARY TEACHER	Certificated	T07	05	P	A	1.00	74,436	1.00	77,982
EDN100/AA	6/1/2013	68039	SECONDARY TEACHER	Certificated	T07	05	P	A	1.00	74,436	1.00	77,982
EDN100/AA	6/1/2013	67676	ELEM TEACHER	Certificated	T07	05	P	A	1.00	75,419	1.00	77,982
EDN100/AA	6/1/2013	71474	VICE PRINCIPAL IV	Certificated	E06	06	P	A	1.00	85,640	1.00	79,404
EDN100/AA	6/1/2013	71424	VICE PRINCIPAL III	Certificated	E05	06	P	A	1.00	85,640	1.00	82,786
EDN100/AA	6/1/2013	75249	12-MO STUDENT SVCS COORD	Certificated	T04	05	T	A	1.00	73,686	1.00	82,863
EDN100/AA	6/1/2013	64967	SECONDARY TEACHER	Certificated	T07	05	P	A	1.00	70,222	1.00	86,516
EDN100/AA	6/1/2013	68048	VICE PRINCIPAL IV	Certificated	E06	06	P	A	1.00	95,716	1.00	88,746
EDN100/AA	6/1/2013	68770	ELEM TEACHER	Certificated	T07	05	P	A	1.00	74,436	1.00	91,707
EDN100/AA	6/1/2013	65811	12-MO HS PRIN VI	Certificated	E09	06	P	A	1.00	121,294	1.00	121,294
EDN100/AA	6/4/2013	16523	SCHOOL CUSTODIAN II	N	BC02	01	P	A	1.00	33,228	1.00	33,228
EDN150/FA	6/4/2013	603684	SPEC ED TEACHER	Certificated	T02	05	T	A			1.00	42,509
EDN100/AA	6/4/2013	63684	SECONDARY TEACHER	Certificated	T02	05	T	A	1.00	40,567	1.00	43,785
EDN200/GN	6/6/2013	58053	OFFICE ASSISTANT III	N	SR08	03	P	A	1.00	24,253	1.00	13,327
EDN150/FA	6/6/2013	603471	SPEC ED TCHR/PRE-SCHOOL	Certificated	T02	05	T	A			1.00	42,509
EDN100/AA	6/8/2013	30597	SCHOOL SECURITY ATTENDANT	N	SR07	03	P	A	1.00	24,148	1.00	20,540
EDN100/AA	6/8/2013	36296	OFFICE ASSISTANT III	N	SR08	03	P	A	1.00	28,836	1.00	25,668
EDN100/AA	6/8/2013	64291X	ELEM TEACHER	Certificated	T03	05	T	A	1.00	46,609	1.00	45,909
EDN150/YC	6/8/2013	58465	BEHAVIORAL HLTH SPCLT IV	N	SR22	13	P	A	1.00	53,264	1.00	57,708
EDN100/AA	6/11/2013	67498	SECONDARY TEACHER	Certificated	T02	05	P	A	1.00	43,048	1.00	45,098
EDN150/YG	6/12/2013	800271	EDUC ASST III	Y	SR12	03	P	A	1.00	24,109	1.00	25,030
EDN100/AA	6/14/2013	56803	SCHOOL CUSTODIAN II	N	BC02	01	P	A	0.50	16,614	0.50	16,614
EDN100/AA	6/14/2013	61156	ELEM TEACHER	Certificated	T02	05	P	A	1.00	43,822	1.00	45,098
EDN150/NB	6/15/2013	801771	EDUC ASST III	Y	SR12	03	T	N			0.75	18,773
EDN400/OC	6/15/2013	24786	CARPENTER I	N	BC09	01	P	A	1.00	43,194	1.00	23,134
EDN100/BM	6/15/2013	801114	ATHLETIC HLTH CARE TRAINER	Y	SR22	13	P	A	1.00	42,073	1.00	45,576
EDN150/FA	6/15/2013	62115	SPEC ED TEACHER	Certificated	T02	05	P	A			1.00	49,991
EDN150/YC	6/15/2013	58668	CLINICAL PSYCHOLOGIST VI	N	SR26	13	P	A	1.00	60,939	1.00	55,500
EDN100/AA	6/15/2013	69120	ELEM TEACHER	Certificated	T07	05	P	A	1.00	43,822	1.00	72,455
EDN100/AA	6/18/2013	14692	OFFICE ASSISTANT III	N	SR08	03	P	A	1.00	25,668	1.00	25,668
EDN100/AA	6/20/2013	60494	ELEM TEACHER	Certificated	T05	05	P	A	1.00	53,348	1.00	55,888
EDN150/FA	6/21/2013	56701	EDUC ASST III	Y	SR12	03	T	A	0.75	19,686	0.75	20,265
EDN100/AA	6/21/2013	603696	ELEM TEACHER	Certificated	T03	05	T	A			1.00	45,909
EDN150/YC	6/21/2013	58499	BEHAVIORAL HLTH SPCLT IV	N	SR22	13	P	A	1.00	49,243	1.00	53,352
EDN100/BS	6/21/2013	72058	ROTC INSTRUCTOR	Certificated	ROTC	05	T	A	1.00	79,276	1.00	85,024
EDN400/MC	6/26/2013	800731	PRGM SPCLT VI	N	SR26	13	T	N	1.00	55,500	1.00	55,500
EDN150/FA	6/27/2013	67192	SPEC ED TEACHER	Certificated	T02	05	P	A	1.00	52,796	1.00	42,509
EDN100/AA	6/28/2013	601189	ELEM TEACHER	Certificated	T02	05	T	A			1.00	42,509
EDN100/DB	6/29/2013	802678	DISTRICT PCNC ASSISTANT	N	SR15	03	T	N			0.50	8,764
EDN100/AA	6/29/2013	37534	EDUC ASST III	Y	SR12	03	T	A	0.50	13,066	0.50	12,515

Prog ID/Org	Separation Date	Position Number	Position Title	Exempt (Y/N)	SR Level	BU Code	T/P	MOF	Budgeted FTE	Budgeted Salary	Actual FTE	Actual Salary
EDN150/FA	6/29/2013	57474	EDUC ASST III	Y	SR12	03	T	A	0.50	12,158	0.50	12,515
EDN100/AA	6/29/2013	54862	OFFICE ASSISTANT III	N	SR08	03	T	A	0.50	13,878	0.50	13,878
EDN150/FA	6/29/2013	56770	EDUC ASST III	Y	SR12	03	T	A	0.50	13,663	0.50	14,065
EDN150/FA	6/29/2013	56985	EDUC ASST III	Y	SR12	03	T	A	0.50	14,193	0.50	14,610
EDN200/GN	6/29/2013	32180	BILINGUAL/BICULTURAL S/H ASST	Y	SR11	03	T	A	0.50	14,176	0.50	15,606
EDN200/GN	6/29/2013	58664	BILINGUAL/BICULTURAL S/H ASST	Y	SR11	03	T	A	0.50	14,726	0.50	16,212
EDN100/DB	6/29/2013	32410	EDUC ASST III	Y	SR12	03	T	N			0.50	16,450
EDN100/AA	6/29/2013	801141	SCHOOL CUSTODIAN II	N	BC02	01	T	A	0.50	16,614	0.50	16,614
EDN100/AA	6/29/2013	801376	SCHOOL CUSTODIAN II	N	BC02	01	T	A			0.50	16,614
EDN100/AA	6/29/2013	46020	OFFICE ASSISTANT III	N	SR08	03	P	A	0.50	16,878	0.50	16,878
EDN150/FA	6/29/2013	57338	EDUC ASST II	Y	SR10	03	T	A	0.75	18,237	0.75	17,348
EDN150/FA	6/29/2013	57763	EDUC ASST III	Y	SR12	03	T	A	0.75	21,289	0.75	18,773
EDN150/FA	6/29/2013	57029	EDUC ASST III	Y	SR12	03	T	A	0.75	18,237	0.75	18,773
EDN150/FA	6/29/2013	54501	EDUC ASST III	Y	SR12	03	T	A	0.75	18,237	0.75	18,773
EDN150/FA	6/29/2013	56771	EDUC ASST III	Y	SR12	03	T	A	0.75	20,495	0.75	18,773
EDN150/FA	6/29/2013	52592	EDUC ASST III	Y	SR12	03	T	A	0.75	18,237	0.75	18,773
EDN150/FA	6/29/2013	57522	EDUC ASST III	Y	SR12	03	T	A	0.75	18,237	0.75	18,773
EDN150/FA	6/29/2013	58118	EDUC ASST III	Y	SR12	03	P	A	0.75	18,950	0.75	19,508
EDN100/AA	6/29/2013	802278	SCHOOL SECURITY ATTENDANT	N	SR07	03	T	A			1.00	20,540
EDN100/AA	6/29/2013	801675	SCHOOL SECURITY ATTENDANT	N	SR07	03	T	A			1.00	20,540
EDN150/FA	6/29/2013	58075	EDUC ASST III	Y	SR12	03	P	A	0.75	20,495	0.75	21,097
EDN150/NB	6/29/2013	58188	EDUC ASST I	Y	SR08	03	T	N			1.00	21,390
EDN150/YC	6/29/2013	58542	BEHAVIORAL HLTH SPCLT III	N	SR20	13	T	A	1.00	42,066	1.00	21,881
EDN150/NB	6/29/2013	57168	EDUC ASST II	Y	SR10	03	T	N			1.00	23,130
EDN150/NB	6/29/2013	802486	EDUC ASST III	Y	SR12	03	P	N			1.00	25,030
EDN150/FB	6/29/2013	800648	EDUC ASST III	Y	SR12	03	P	A	1.00	24,095	1.00	25,030
EDN150/FA	6/29/2013	800489	EDUC ASST III	Y	SR12	03	T	A	1.00	24,314	1.00	25,030
EDN100/AA	6/29/2013	800874	OFFICE ASSISTANT III	N	SR08	03	T	A	1.00	25,668	1.00	25,668
EDN150/FA	6/29/2013	57361	EDUC ASST III	Y	SR12	03	T	A	1.00	25,266	1.00	26,010
EDN100/AA	6/29/2013	800705	ACCOUNT CLERK II	N	SR08	03	T	A	1.00	26,700	1.00	26,700
EDN100/AA	6/29/2013	29314	SCHOOL HEALTH AIDE	N	SR09	03	P	A	1.00	25,730	1.00	26,731
EDN150/NB	6/29/2013	800359	EDUC ASST III	Y	SR12	03	T	N			1.00	27,020
EDN150/FA	6/29/2013	50342	EDUC ASST III	Y	SR12	03	T	A	1.00	26,248	1.00	27,020
EDN150/SA	6/29/2013	30936	COMMUNICATION AIDE	Y	SR12	03	P	A	1.00	28,143	1.00	29,220
EDN150/FA	6/29/2013	57033	EDUC ASST III	Y	SR12	03	P	A	1.00	28,385	1.00	29,220
EDN100/AA	6/29/2013	40782	OFFICE ASSISTANT III	N	SR08	03	P	A	1.00	30,036	1.00	30,036
EDN150/FA	6/29/2013	65993	SPEC ED TEACHER	Certificated	T02	05	P	A	1.00	51,755	1.00	32,222
EDN100/AA	6/29/2013	23581	SCHOOL CUSTODIAN II	N	BC02	01	P	A	1.00	33,228	1.00	33,228
EDN150/FA	6/29/2013	46190	EDUC ASST III	Y	SR12	03	P	A	1.00	33,223	1.00	34,200
EDN100/AA	6/29/2013	16736	SCHOOL CUSTODIAN III	N	WS02	01	P	A	1.00	35,544	1.00	35,544
EDN150/FA	6/29/2013	52541	EDUC ASST III	Y	SR12	03	P	A	1.00	33,978	1.00	36,516
EDN100/AA	6/29/2013	16617	SCHOOL CUSTODIAN IV	N	F102	02	P	A	1.00	36,684	1.00	36,684
EDN100/AA	6/29/2013	21890	SWIMMING POOL CUSTODIAN	N	BC05	01	P	A	1.00	36,960	1.00	36,960
EDN400/MD	6/29/2013	9215	SCHOOL COOK II	N	BC06	01	P	B	1.00	12,012	1.00	38,436
EDN400/MD	6/29/2013	8896	SCHOOL COOK II	N	BC06	01	P	B	1.00	12,012	1.00	38,436

Prog ID/Org	Separation Date	Position Number	Position Title	Exempt (Y/N)	SR Level	BU Code	T/P	MOF	Budgeted FTE	Budgeted Salary	Actual FTE	Actual Salary
EDN100/AA	6/29/2013	23734	SCHOOL CUSTODIAN V	N	F202	02	P	A	1.00	39,036	1.00	39,036
EDN200/GN	6/29/2013	29999	BILINGUAL/BICULTURAL S/H ASST	Y	SR11	03	T	A	1.00	35,862	1.00	39,480
EDN150/YG	6/29/2013	802597	BEHAVIORAL HLTH SPCLT III	N	SR20	13	T	A			1.00	42,132
EDN100/AA	6/29/2013	61658	SECONDARY TEACHER	Certificated	T02	05	P	A	1.00	74,436	1.00	42,509
EDN100/AA	6/29/2013	65835	ELEM TEACHER	Certificated	T02	05	T	A	1.00	47,474	1.00	42,509
EDN100/AA	6/29/2013	62185	SECONDARY TEACHER	Certificated	T02	05	P	A	1.00	41,794	1.00	43,785
EDN200/GN	6/29/2013	32181	BILINGUAL/BICULTURAL S/H ASST	Y	SR11	03	T	A	1.00	40,342	1.00	44,412
EDN100/BM	6/29/2013	801120	ATHLETIC HLTH CARE TRAINER	Y	SR22	13	P	A	1.00	42,073	1.00	45,576
EDN300/KO	6/29/2013	19380	PERSONNEL MGMT SPECIALIST IV	N	SR22	13	P	A	1.00	40,660	1.00	45,576
EDN100/AA	6/29/2013	60329	ELEM TEACHER	Certificated	T03	05	P	A	1.00	38,142	1.00	45,909
EDN100/AA	6/29/2013	1933	SCHOOL ADM SERVICES ASST III	Certificated	SR16	04	P	A	1.00	35,064	1.00	46,176
EDN100/AA	6/29/2013	16089	SCHOOL & SWMG POOL CUSTODN V	N	F205	02	P	A	1.00	46,272	1.00	46,272
EDN100/AA	6/29/2013	24897	SCHOOL ADM SERVICES ASST III	Certificated	SR16	04	P	A	1.00	48,048	1.00	48,048
EDN400/MB	6/29/2013	6852	SECRETARY III	N	SR16	03	P	N			1.00	48,048
EDN100/AA	6/29/2013	1880	SCHOOL ADM SERVICES ASST IV	Certificated	SR18	04	P	A	1.00	48,048	1.00	48,048
EDN100/AA	6/29/2013	600635	SECONDARY TEACHER	Certificated	T03	05	T	A			1.00	48,706
EDN150/YC	6/29/2013	58089	SOCIAL WORKER IV	N	SR22	13	P	A	1.00	45,533	1.00	49,332
EDN100/AA	6/29/2013	60648	SECONDARY TEACHER	Certificated	T07	05	P	A	1.00	55,482	1.00	58,074
EDN300/KO	6/29/2013	603378	SR DIRECTOR OF HR	Certificated	E10	06	T	A			1.00	110,626
EDN150/FA	7/1/2013	53135	EDUC ASST III	Y	SR12	03	P	A	0.75	20,609	0.75	21,097
EDN150/NB	7/1/2013	802487	EDUC ASST III	Y	SR12	03	P	N			1.00	25,030
EDN400/MD	7/1/2013	11528	SCHOOL COOK II	N	BC06	01	P	A			1.00	38,436
EDN150/FA	7/1/2013	71864	SPEC ED TEACHER	Certificated	T02	05	P	A	1.00	53,606	1.00	42,509
EDN100/AA	7/1/2013	68162	SECONDARY TEACHER	Certificated	T02	05	P	A	1.00	59,388	1.00	42,509
EDN100/AA	7/1/2013	66435	ELEM TEACHER	Certificated	T02	05	P	A	1.00	42,204	1.00	42,509
EDN100/AA	7/1/2013	69198	ELEM TEACHER	Certificated	T02	05	P	A	1.00	74,305	1.00	42,509
EDN100/DB	7/1/2013	600101	ELEM TEACHER	Certificated	T02	05	T	N			1.00	42,509
EDN100/AA	7/1/2013	71879	ELEM TEACHER	Certificated	T02	05	P	A	1.00	42,204	1.00	42,509
EDN150/NB	7/1/2013	79532	DIST OFF TCHR	Certificated	T02	05	T	N			1.00	42,509
EDN100/AA	7/1/2013	61647	SECONDARY TEACHER	Certificated	T02	05	P	A	1.00	44,774	1.00	42,509
EDN150/FA	7/1/2013	600027	SPEC ED TEACHER	Certificated	T03	05	T	A	1.00	43,611	1.00	45,909
EDN150/FA	7/1/2013	73212	SPEC ED TEACHER	Certificated	T03	05	P	A			1.00	45,909
EDN100/AA	7/1/2013	73706	COUNSELOR	Certificated	T03	05	P	A	1.00	50,290	1.00	45,909
EDN100/AA	7/1/2013	72310	ELEM TEACHER	Certificated	T03	05	P	A	1.00	46,948	1.00	45,909
EDN150/FA	7/1/2013	601885	SPEC ED TEACHER	Certificated	T03	05	T	A	1.00	43,611	1.00	45,909
EDN100/BB	7/1/2013	65274	SECONDARY TEACHER	Certificated	T03	05	P	A	1.00	40,941	1.00	48,706
EDN100/AA	7/1/2013	71956	SECONDARY TEACHER	Certificated	T03	05	P	A	1.00	49,806	1.00	50,167
EDN100/AA	7/1/2013	72073	12-MO STUDENT SVCS COORD	Certificated	T04	05	T	A	1.00	60,348	1.00	50,654
EDN100/AA	7/1/2013	69066	ELEM TEACHER	Certificated	T03	05	P	A	1.00	51,301	1.00	51,673
EDN100/AA	7/1/2013	1926	SCHOOL ADM SERVICES ASST III	Certificated	SR16	04	P	A	1.00	52,819	1.00	54,012
EDN100/AA	7/1/2013	66401	SECONDARY TEACHER	Certificated	T03	05	P	A	1.00	54,425	1.00	54,819
EDN100/AA	7/1/2013	73135	12-MO STUDENT SVCS COORD	Certificated	T03	05	T	A	1.00	65,310	1.00	54,819
EDN150/FA	7/1/2013	73309	SPEC ED TEACHER	Certificated	T06	05	P	A	1.00	53,606	1.00	56,431
EDN100/AA	7/1/2013	73695	COUNSELOR	Certificated	T03	05	P	A	1.00	57,324	1.00	56,464
EDN150/NB	7/1/2013	79820	12-MO DIST OFF TCHR	Certificated	T04	05	T	N			1.00	57,011

<u>Prog ID/Org</u>	<u>Separation Date</u>	<u>Position Number</u>	<u>Position Title</u>	<u>Exempt (Y/N)</u>	<u>SR Level</u>	<u>BU Code</u>	<u>T/P</u>	<u>MOF</u>	<u>Budgeted FTE</u>	<u>Budgeted Salary</u>	<u>Actual FTE</u>	<u>Actual Salary</u>
EDN150/SA	7/1/2013	50753	HUMAN SVCS PROF IV	N	SR22	13	P	A	1.00	54,744	1.00	57,708
EDN100/AA	7/1/2013	67225	SECONDARY TEACHER	Certificated	T04	05	P	A	1.00	58,300	1.00	58,722
EDN150/FA	7/1/2013	74130	SPEC ED TEACHER	Certificated	T07	05	P	A	1.00	56,823	1.00	59,818
EDN100/AA	7/1/2013	66305	SECONDARY TEACHER	Certificated	T04	05	P	A	1.00	60,049	1.00	60,483
EDN200/GN	7/1/2013	73639	COMPLEX AREA TEACHER	Certificated	T03	05	P	A	1.00	55,242	1.00	61,664
EDN100/AA	7/1/2013	73455	12-MO STUDENT SVCS COORD	Certificated	T03	05	T	A	1.00	73,507	1.00	61,699
EDN100/AA	7/1/2013	68590	SECONDARY TEACHER	Certificated	T07	05	P	A	1.00	63,004	1.00	63,460
EDN100/AA	7/1/2013	63914	ELEM TEACHER	Certificated	T06	05	P	A	1.00	63,058	1.00	63,514
EDN100/AA	7/1/2013	65240	ELEM TEACHER	Certificated	T06	05	P	A	1.00	63,058	1.00	63,514
EDN100/AA	7/1/2013	69581	LIBRARIAN	Certificated	T06	05	P	A	1.00	64,324	1.00	63,514
EDN100/AA	7/1/2013	62290	12-MO ELEM TEACHER	Certificated	T07	05	T	A	1.00	77,872	1.00	65,363
EDN100/AA	7/1/2013	71242	ELEM TEACHER	Certificated	T07	05	P	A	1.00	66,841	1.00	67,325
EDN100/AA	7/1/2013	74170	12-MO STUDENT SVCS COORD	Certificated	T07	05	T	A	1.00	80,209	1.00	67,325
EDN100/AA	7/1/2013	67367	SECONDARY TEACHER	Certificated	T06	05	P	A	1.00	66,897	1.00	67,381
EDN150/FA	7/1/2013	71102	SPEC ED TCHR/PRE-SCHOOL	Certificated	T07	05	P	A	1.00	65,872	1.00	69,344
EDN100/AA	7/1/2013	69490	ELEM TEACHER	Certificated	T07	05	P	A	1.00	64,277	1.00	70,346
EDN100/AA	7/1/2013	60145	ELEM TEACHER	Certificated	T07	05	P	A	1.00	70,911	1.00	71,425
EDN100/AA	7/1/2013	66193	SCH ATHLETIC DIR II	Certificated	E02	06	P	A	1.00	70,306	1.00	71,894
EDN100/AA	7/1/2013	67993	12-MO STUDENT SVCS COORD	Certificated	T07	05	T	A	1.00	87,646	1.00	73,567
EDN150/FA	7/1/2013	73290	SPEC ED TCHR/PRE-SCHOOL	Certificated	T07	05	P	A	1.00	75,540	1.00	73,567
EDN100/AA	7/1/2013	68713	SECONDARY TEACHER	Certificated	T06	05	P	A	1.00	73,038	1.00	73,567
EDN100/AA	7/1/2013	71627	ELEM TEACHER	Certificated	T05	05	P	A	1.00	64,325	1.00	76,195
EDN200/GN	7/1/2013	76082	COMPLX SCH RENEW SPEC II	Certificated	E07	06	T	A	1.00	70,007	1.00	77,069
EDN150/SA	7/1/2013	67003	DIST OFF TCHR	Certificated	T07	05	P	A	1.00	73,038	1.00	77,982
EDN100/AA	7/1/2013	71397	12-MO COUNSELOR	Certificated	T07	05	P	A	1.00	92,905	1.00	77,982
EDN100/AA	7/1/2013	62377	ELEM TEACHER	Certificated	T07	05	P	A	1.00	78,443	1.00	77,982
EDN100/AA	7/1/2013	75183	12-MO STUDENT SVCS COORD	Certificated	T07	05	T	A	1.00	92,905	1.00	77,982
EDN100/AA	7/1/2013	75236	12-MO STUDENT SVCS COORD	Certificated	T07	05	T	A	1.00	92,905	1.00	77,982
EDN100/AA	7/1/2013	65751	ELEM TEACHER	Certificated	T07	05	P	A	1.00	77,421	1.00	77,982
EDN100/AA	7/1/2013	66922	ELEM TEACHER	Certificated	T07	05	P	A	1.00	68,845	1.00	81,549
EDN100/DB	7/1/2013	603645	SECONDARY TEACHER	Certificated	T07	05	T	N			1.00	81,549
EDN150/YG	7/1/2013	76102	DISTRICT EDUC SPEC II	Certificated	E07	06	T	A	1.00	82,853	1.00	89,803
EDN100/AA	7/1/2013	67738	COUNSELOR	Certificated	T07	05	T	A			1.00	91,707
EDN200/GN	7/1/2013	60087	COMPLX SCH RENEW SPEC II	Certificated	E07	06	P	A	1.00	91,170	1.00	100,367
EDN100/BS	7/1/2013	73417	ROTC INSTRUCTOR	Certificated	ROTC	05	T	A	1.00	95,404	1.00	106,191
EDN300/KF	7/1/2013	60082	BUDGET SPECIALIST II	Certificated	E07	06	P	A	1.00	97,835	1.00	109,099
EDN300/KO	7/1/2013	67857	PERS REGIONAL OFFICER II	Certificated	E07	06	P	A	1.00	97,584	1.00	109,099
EDN200/GC	7/1/2013	60081	EDUCATIONAL SPEC III	Certificated	E08	06	P	A	1.00	99,073	1.00	110,626
EDN100/BS	7/1/2013	73150	ROTC INSTRUCTOR	Certificated	ROTC	05	T	A	1.00	98,823	1.00	113,920
EDN100/AA	7/1/2013	63992	12-MO ELEM PRIN II	Certificated	E06	06	P	A	1.00	123,667	1.00	126,460
EDN100/AA	7/1/2013	61258	12-MO INTER PRIN V	Certificated	E08	06	P	A	1.00	127,151	1.00	130,023
EDN100/AA	7/1/2013	66298	12-MO INTER PRIN V	Certificated	E08	06	P	A	1.00	134,423	1.00	137,459
EDN100/AA	7/2/2013	34328	SCHOOL CUSTODIAN II	N	BC02	01	P	A	1.00	32,494	1.00	33,228
EDN100/AA	7/2/2013	1874	SCHOOL ADM SERVICES ASST III	Certificated	SR16	04	P	A	1.00	41,741	1.00	44,412
EDN100/AA	7/2/2013	73715	SECONDARY TEACHER	Certificated	T03	05	P	A	1.00	45,579	1.00	45,909

<u>Prog ID/Org</u>	<u>Separation Date</u>	<u>Position Number</u>	<u>Position Title</u>	<u>Exempt (Y/N)</u>	<u>SR Level</u>	<u>BU Code</u>	<u>T/P</u>	<u>MOF</u>	<u>Budgeted FTE</u>	<u>Budgeted Salary</u>	<u>Actual FTE</u>	<u>Actual Salary</u>
EDN300/KO	7/4/2013	15437	PERSONNEL CLERK V	N	SR13	03	P	A	1.00	34,108	1.00	16,211
EDN150/YG	7/4/2013	801834	EDUC ASST II	Y	SR10	03	T	A	1.00	27,712	1.00	28,836
EDN100/AA	7/5/2013	66080	SECONDARY TEACHER	Certificated	T03	05	P	A	1.00	48,356	1.00	51,673
EDN150/FA	7/6/2013	56066	EDUC ASST II	Y	SR10	03	P	A	1.00	27,479	1.00	24,030
EDN150/FA	7/6/2013	76167	SPEC ED TEACHER	Certificated	T03	05	P	A	1.00	40,381	1.00	48,678
EDN150/YC	7/6/2013	802389	SCHOOL PSYCHOLOGIST	Y	SR24	13	P	A	1.00	54,194	1.00	51,312
EDN100/AA	7/9/2013	72037	SECONDARY TEACHER	Certificated	T04	05	P	A	1.00	51,798	1.00	52,173
EDN150/NB	7/9/2013	79808	12-MO DIST OFF TCHR	Certificated	T03	05	T	N			1.00	61,817
EDN150/SA	7/11/2013	50768	SOCIAL WORKER IV	N	SR22	13	P	A	1.00	43,235	1.00	24,613
EDN150/SA	7/11/2013	47673	SPEECH PATHOLOGIST IV	Y	SR22	13	P	A	1.00	54,027	1.00	47,400
EDN150/YC	7/11/2013	800567	SCHOOL PSYCHOLOGIST	Y	SR24	13	T	A	1.00	54,194	1.00	53,364
EDN100/CB	7/13/2013	50395	PERSONNEL CLERK IV	N	SR11	03	P	A	1.00	26,633	1.00	14,969
EDN150/FA	7/13/2013	68485	SPEC ED TEACHER	Certificated	T02	05	P	A	1.00	34,380	1.00	49,991
EDN150/YC	7/13/2013	800932	SCHOOL PSYCHOLOGIST	Y	SR24	13	P	A	1.00	54,194	1.00	53,364
EDN150/FA	7/13/2013	600361	SPEC ED TEACHER	Certificated	T03	05	T	A			1.00	53,990
EDN300/KF	7/13/2013	603697	FISCAL SPECIALIST II	Certificated	E07	06	P	A			1.00	77,069
EDN100/AA	7/14/2013	64528	SECONDARY TEACHER	Certificated	T02	05	P	A	1.00	42,204	1.00	49,991
EDN100/AA	7/15/2013	67435	ELEM TEACHER	Certificated	T03	05	P	A	1.00	45,579	1.00	53,990
EDN100/AA	7/15/2013	72020	SECONDARY TEACHER	Certificated	T07	05	P	A	1.00	70,911	1.00	71,425
EDN150/FA	7/15/2013	73739	SPEC ED TEACHER	Certificated	T07	05	P	A	1.00	60,283	1.00	74,630
EDN150/FA	7/16/2013	800152	EDUC ASST III	Y	SR12	03	T	A	0.75	18,338	0.75	19,508
EDN100/AA	7/16/2013	52596	SCHOOL SECURITY ATTENDANT	N	SR07	03	P	A	1.00	23,615	1.00	23,130
EDN150/SA	7/16/2013	801316	EDUCATIONAL INTERPRETER I	N	SR12	03	P	A	1.00	25,734	1.00	32,424
EDN150/FA	7/16/2013	68549	SPEC ED TEACHER	Certificated	T02	05	P	A			1.00	37,893
EDN100/BV	7/16/2013	61880	ELEM TEACHER	Certificated	T02	05	T	A	1.00	30,148	1.00	37,893
EDN150/FB	7/16/2013	60268	SPECIAL SCH TEACHER	Certificated	T02	05	P	A	1.00	44,268	1.00	37,893
EDN150/FA	7/16/2013	62156	SPEC ED TEACHER	Certificated	T02	05	P	A			1.00	37,893
EDN150/FA	7/16/2013	74419	SPEC ED TEACHER	Certificated	T02	05	P	A	1.00	49,086	1.00	37,893
EDN100/AA	7/16/2013	65207	SECONDARY TEACHER	Certificated	T02	05	P	A	1.00	46,117	1.00	37,893
EDN150/SA	7/16/2013	58826	SPEECH PATHOLOGIST IV	Y	SR22	13	P	A	1.00	51,005	1.00	47,400
EDN100/BM	7/16/2013	800531	ATHLETIC HLTH CARE TRAINER	Y	SR22	13	P	A	1.00	42,073	1.00	47,400
EDN150/YC	7/16/2013	801826	BEHAVIORAL HLTH SPCLT IV	N	SR22	13	P	A	1.00	42,066	1.00	47,400
EDN100/AA	7/16/2013	61725	SECONDARY TEACHER	Certificated	T03	05	P	A	1.00	48,356	1.00	48,706
EDN150/YC	7/16/2013	58505	BEHAVIORAL HLTH SPCLT IV	N	SR22	13	T	A	1.00	43,761	1.00	49,308
EDN150/FA	7/16/2013	75621	GEN EDUC/ARTICLE VI TCHR	Certificated	T02	05	T	A	1.00	56,011	1.00	49,991
EDN150/FA	7/16/2013	72393	SPEC ED TEACHER	Certificated	T02	05	P	A	1.00	48,118	1.00	49,991
EDN100/AA	7/16/2013	603654	ELEM TEACHER	Certificated	T02	05	T	A			1.00	49,991
EDN150/FA	7/16/2013	75656	SPEC ED TEACHER	Certificated	T02	05	T	A	1.00	40,381	1.00	49,991
EDN150/FA	7/16/2013	73244	SPEC ED TEACHER	Certificated	T02	05	P	A			1.00	49,991
EDN150/FA	7/16/2013	75647	SPEC ED TEACHER	Certificated	T02	05	T	A	1.00	40,994	1.00	49,991
EDN100/AA	7/16/2013	68569	SECONDARY TEACHER	Certificated	T02	05	P	A	1.00	48,356	1.00	49,991
EDN150/FA	7/16/2013	68700	SPEC ED TEACHER	Certificated	T02	05	P	A	1.00	51,544	1.00	49,991
EDN150/FB	7/16/2013	75795	SPEC ED TEACHER	Certificated	T02	05	P	A	1.00	39,795	1.00	49,991
EDN150/FA	7/16/2013	71148	SPEC ED TEACHER	Certificated	T02	05	P	A	1.00	41,593	1.00	51,491
EDN100/AA	7/16/2013	67509	SECONDARY TEACHER	Certificated	T02	05	P	A	1.00	43,470	1.00	51,491

Department of Education
Personnel Separations

Table 15

<u>Prog ID/Org</u>	<u>Separation Date</u>	<u>Position Number</u>	<u>Position Title</u>	<u>Exempt (Y/N)</u>	<u>SR Level</u>	<u>BU Code</u>	<u>T/P</u>	<u>MOF</u>	<u>Budgeted FTE</u>	<u>Budgeted Salary</u>	<u>Actual FTE</u>	<u>Actual Salary</u>
EDN100/AA	7/16/2013	69821	ELEM TEACHER	Certificated	T02	05	P	A	1.00	43,470	1.00	51,491
EDN150/FA	7/16/2013	68781	SPEC ED TEACHER	Certificated	T02	05	P	A	1.00	42,840	1.00	53,036
EDN150/NB	7/16/2013	600555	DIST OFF TCHR	Certificated	T03	05	T	N			1.00	53,990
EDN150/FA	7/16/2013	69805	SPEC ED TCHR/PRE-SCHOOL	Certificated	T03	05	P	A			1.00	53,990
EDN100/AA	7/16/2013	63182	SECONDARY TEACHER	Certificated	T03	05	P	A	1.00	39,671	1.00	53,990
EDN100/AA	7/16/2013	63773	SECONDARY TEACHER	Certificated	T03	05	P	A	1.00	42,204	1.00	53,990
EDN100/AA	7/16/2013	68936	SECONDARY TEACHER	Certificated	T03	05	P	A	1.00	45,579	1.00	53,990
EDN100/AA	7/16/2013	64570	SECONDARY TEACHER	Certificated	T03	05	P	A	1.00	39,671	1.00	53,990
EDN100/AA	7/16/2013	61930	SECONDARY TEACHER	Certificated	T03	05	P	A	1.00	39,671	1.00	53,990
EDN150/FA	7/16/2013	71630	SPEC ED TEACHER	Certificated	T03	05	P	A	1.00	43,611	1.00	53,990
EDN150/FA	7/16/2013	63778	GEN EDUC/ARTICLE VI TCHR	Certificated	T03	05	P	A	1.00	43,507	1.00	53,990
EDN100/AA	7/16/2013	600939	ELEM TEACHER	Certificated	T03	05	T	A	1.00	59,388	1.00	53,990
EDN100/AA	7/16/2013	63953	SECONDARY TEACHER	Certificated	T03	05	P	A	1.00	70,911	1.00	53,990
EDN150/FA	7/16/2013	75502	GEN EDUC/ARTICLE VI TCHR	Certificated	T03	05	T	A			1.00	53,990
EDN100/AA	7/16/2013	63605	ELEM TEACHER	Certificated	T03	05	P	A	1.00	45,579	1.00	53,990
EDN150/FA	7/16/2013	72224	SPEC ED TEACHER	Certificated	T03	05	P	A	1.00	42,840	1.00	53,990
EDN100/AA	7/16/2013	69733	SECONDARY TEACHER	Certificated	T03	05	P	A	1.00	46,948	1.00	55,611
EDN100/AA	7/16/2013	71600	ELEM TEACHER	Certificated	T03	05	P	A	1.00	46,948	1.00	55,611
EDN100/AA	7/16/2013	64536	SECONDARY TEACHER	Certificated	T03	05	P	A	1.00	48,356	1.00	57,279
EDN100/AA	7/16/2013	66589	SECONDARY TEACHER	Certificated	T03	05	P	A	1.00	48,356	1.00	57,279
EDN150/FA	7/16/2013	64480	GEN EDUC/ARTICLE VI TCHR	Certificated	T03	05	T	A	1.00	37,867	1.00	57,279
EDN150/FA	7/16/2013	62048	SPEC ED TEACHER	Certificated	T03	05	T	A			1.00	57,279
EDN150/FA	7/16/2013	64957	SPEC ED TEACHER	Certificated	T04	05	P	A	1.00	48,118	1.00	59,570
EDN100/AA	7/16/2013	63745	SECONDARY TEACHER	Certificated	T05	05	P	A	1.00	50,290	1.00	61,953
EDN100/AA	7/16/2013	69639	SECONDARY TEACHER	Certificated	T07	05	P	A	1.00	52,809	1.00	66,308
EDN100/AA	7/17/2013	802208	EDUC ASST III	Y	SR12	03	T	A	0.75	19,166	0.75	19,508
EDN150/FA	7/17/2013	51912	EDUC ASST III	Y	SR12	03	P	A	1.00	24,450	1.00	26,010
EDN400/OC	7/17/2013	55076	ENGINEER V	N	SR26	13	P	A	1.00	63,024	1.00	29,970
EDN300/KO	7/18/2013	15440	PERSONNEL CLERK IV	N	SR11	03	P	A	1.00	29,002	1.00	33,756
EDN100/AA	7/18/2013	60535	COUNSELOR	Certificated	T03	05	P	A	1.00	45,579	1.00	45,909
EDN150/FA	7/18/2013	76071	SPEC ED TEACHER	Certificated	T03	05	P	A	1.00	44,920	1.00	47,287
EDN100/AA	7/19/2013	67344	ELEM TEACHER	Certificated	T05	05	T	A	1.00	52,302	1.00	52,680
EDN300/KO	7/20/2013	19240	PERSONNEL CLERK V	N	SR13	03	P	A	1.00	38,080	1.00	16,211
EDN100/BX	7/20/2013	67899	TEACHER/DORMITORY	Certificated	T02	05	P	A	1.00	42,380	1.00	45,098
EDN100/AA	7/20/2013	65007	12-MO INTER PRIN V	Certificated	E08	06	P	A	1.00	104,665	1.00	107,029
EDN100/DB	7/23/2013	59583	OFFICE ASSISTANT II	N	SR06	03	T	N			1.00	12,301
EDN150/FA	7/23/2013	64177	SPEC ED TEACHER	Certificated	T02	05	P	A	1.00	40,381	1.00	32,222
EDN100/AA	7/23/2013	71657	SECONDARY TEACHER	Certificated	T02	05	P	A	1.00	42,204	1.00	42,509
EDN150/FA	7/23/2013	76052	SPEC ED TEACHER	Certificated	T02	05	P	A	1.00	41,593	1.00	43,785
EDN100/BJ	7/24/2013	602353	SPECIAL SCH TEACHER	Certificated	T02	05	T	A	0.50	15,299	0.50	16,111
EDN100/AA	7/24/2013	603768	ELEM TEACHER	Certificated	T02	05	T	A			0.50	16,111
EDN100/AA	7/24/2013	74101	10-MO STUDENT SVCS COORD	Certificated	T02	05	P	A	1.00	45,898	0.50	16,111
EDN150/FA	7/24/2013	57207	EDUC ASST III	Y	SR12	03	T	A	0.75	18,338	0.75	18,773
EDN100/AA	7/24/2013	603455	ELEM TEACHER	Certificated	T02	05	T	A			0.50	21,255
EDN100/AA	7/24/2013	603541	ELEM TEACHER	Certificated	T02	05	T	A			0.50	21,893

<u>Prog ID/Org</u>	<u>Separation Date</u>	<u>Position Number</u>	<u>Position Title</u>	<u>Exempt (Y/N)</u>	<u>SR Level</u>	<u>BU Code</u>	<u>T/P</u>	<u>MOF</u>	<u>Budgeted FTE</u>	<u>Budgeted Salary</u>	<u>Actual FTE</u>	<u>Actual Salary</u>
EDN150/FA	7/24/2013	57584	EDUC ASST III	Y	SR12	03	T	A	0.88	21,394	0.88	22,759
EDN100/AA	7/24/2013	74101	10-MO STUDENT SVCS COORD	Certificated	T03	05	P	A	1.00	45,898	0.50	22,955
EDN100/AA	7/24/2013	72727	SECONDARY TEACHER	Certificated	T03	05	P	A	1.00	56,058	0.50	22,955
EDN100/AA	7/24/2013	603507	SECONDARY TEACHER	Certificated	T03	05	T	A			0.50	22,955
EDN100/AA	7/24/2013	601647	SECONDARY TEACHER	Certificated	T03	05	T	A	0.50	24,178	0.50	24,353
EDN100/AA	7/24/2013	601799	SECONDARY TEACHER	Certificated	T05	05	T	A	0.50	23,474	0.50	25,573
EDN100/AA	7/24/2013	602287	ELEM TEACHER	Certificated	T05	05	T	A			0.50	27,130
EDN100/AA	7/24/2013	60835	SECONDARY TEACHER	Certificated	T06	05	P	A	1.00	52,302	0.50	27,393
EDN100/AA	7/24/2013	601760	ELEM TEACHER	Certificated	T02	05	T	A	1.00	31,990	1.00	32,222
EDN100/AA	7/24/2013	72666	SECONDARY TEACHER	Certificated	T02	05	P	A	1.00	48,356	1.00	32,222
EDN150/FA	7/24/2013	71738	SPEC ED TEACHER	Certificated	T02	05	T	A			1.00	32,222
EDN150/FA	7/24/2013	75907	GEN EDUC/ARTICLE VI TCHR	Certificated	T02	05	P	A	1.00	37,867	1.00	32,222
EDN100/AA	7/24/2013	72022	SECONDARY TEACHER	Certificated	T02	05	P	A	1.00	39,671	1.00	32,222
EDN150/FA	7/24/2013	72758	SPEC ED TEACHER	Certificated	T02	05	P	A	1.00	53,256	1.00	32,222
EDN150/FA	7/24/2013	62714	SPEC ED TEACHER	Certificated	T02	05	P	A	1.00	50,875	1.00	32,222
EDN100/BB	7/24/2013	65595	SECONDARY TEACHER	Certificated	T02	05	P	A	1.00	55,932	1.00	32,222
EDN100/AA	7/24/2013	65549	SECONDARY TEACHER	Certificated	T02	05	P	A	1.00	59,388	1.00	32,222
EDN150/FA	7/24/2013	74557	SPEC ED TEACHER	Certificated	T02	05	P	A	1.00	30,609	1.00	32,222
EDN150/FA	7/24/2013	603472	SPEC ED TEACHER	Certificated	T02	05	T	A			1.00	32,222
EDN100/BJ	7/24/2013	602030	SPEC ED TEACHER	Certificated	T02	05	T	A	1.00	30,599	1.00	32,222
EDN100/BJ	7/24/2013	602029	SPEC ED TEACHER	Certificated	T02	05	T	A	1.00	30,599	1.00	32,222
EDN150/FA	7/24/2013	74145	SPEC ED TEACHER	Certificated	T02	05	P	A	1.00	40,381	1.00	32,222
EDN100/AA	7/24/2013	68788	SECONDARY TEACHER	Certificated	T02	05	P	A	1.00	52,302	1.00	32,222
EDN150/FA	7/24/2013	62074	SPEC ED TEACHER	Certificated	T02	05	P	A	1.00	50,043	1.00	32,222
EDN150/FA	7/24/2013	601044	SPEC ED TCHR/PRE-SCHOOL	Certificated	T02	05	P	A	1.00	43,611	1.00	32,222
EDN150/FA	7/24/2013	602935	SPEC ED TEACHER	Certificated	T02	05	T	A			1.00	32,222
EDN150/FA	7/24/2013	60967	SPEC ED TEACHER	Certificated	T02	05	P	A	1.00	46,268	1.00	32,222
EDN100/AA	7/24/2013	64796	SECONDARY TEACHER	Certificated	T02	05	P	A	1.00	31,990	1.00	32,222
EDN150/FA	7/24/2013	60992	SPEC ED TEACHER	Certificated	T02	05	P	A	1.00	43,611	1.00	32,222
EDN150/FA	7/24/2013	602342	SPEC ED TEACHER	Certificated	T02	05	T	A	1.00	30,609	1.00	32,222
EDN150/FA	7/24/2013	74909	SPEC ED TEACHER	Certificated	T02	05	P	A	1.00	43,611	1.00	32,222
EDN150/FA	7/24/2013	66614	SPEC ED TEACHER	Certificated	T02	05	P	A	1.00	46,717	1.00	32,222
EDN150/FA	7/24/2013	62110	SPEC ED TEACHER	Certificated	T02	05	P	A			1.00	32,222
EDN150/FA	7/24/2013	602393	SPEC ED TEACHER	Certificated	T02	05	T	A			1.00	32,222
EDN150/FA	7/24/2013	69582	SPEC ED TEACHER	Certificated	T02	05	P	A	1.00	30,609	1.00	32,222
EDN100/AA	7/24/2013	603049	SECONDARY TEACHER	Certificated	T02	05	T	A			1.00	32,222
EDN100/AA	7/24/2013	60821	SECONDARY TEACHER	Certificated	T02	05	T	A	1.00	43,470	1.00	32,222
EDN150/FA	7/24/2013	602554	SPEC ED TCHR/PRE-SCHOOL	Certificated	T02	05	T	A			1.00	33,169
EDN100/AA	7/24/2013	603388	SECONDARY TEACHER	Certificated	T03	05	T	A			1.00	34,799
EDN150/FA	7/24/2013	76031	SPEC ED TEACHER	Certificated	T03	05	P	A	1.00	48,118	1.00	34,799
EDN100/AA	7/24/2013	75806	SECONDARY TEACHER	Certificated	T03	05	T	A	1.00	46,117	1.00	34,799
EDN100/AA	7/24/2013	65796	SECONDARY TEACHER	Certificated	T03	05	P	A	1.00	57,292	1.00	36,918
EDN150/FA	7/24/2013	74084	SPEC ED TEACHER	Certificated	T02	05	T	A	1.00	37,958	1.00	39,958
EDN150/FA	7/24/2013	603370	SPEC ED TCHR/PRE-SCHOOL	Certificated	T02	05	T	A			1.00	39,958
EDN100/AA	7/24/2013	69595	ELEM TEACHER	Certificated	T02	05	P	A	1.00	45,579	1.00	39,958

Department of Education
Personnel Separations

Table 15

<u>Prog ID/Org</u>	<u>Separation Date</u>	<u>Position Number</u>	<u>Position Title</u>	<u>Exempt (Y/N)</u>	<u>SR Level</u>	<u>BU Code</u>	<u>T/P</u>	<u>MOF</u>	<u>Budgeted FTE</u>	<u>Budgeted Salary</u>	<u>Actual FTE</u>	<u>Actual Salary</u>
EDN100/AA	7/24/2013	61269	SECONDARY TEACHER	Certificated	T02	05	P	A	1.00	39,671	1.00	39,958
EDN150/FA	7/24/2013	74194	SPEC ED TEACHER	Certificated	T02	05	P	A	1.00	46,717	1.00	42,509
EDN100/AA	7/24/2013	71194	ELEM TEACHER	Certificated	T02	05	P	A	1.00	57,657	1.00	42,509
EDN100/AA	7/24/2013	61309	ELEM TEACHER	Certificated	T02	05	P	A	1.00	62,190	1.00	42,509
EDN100/AA	7/24/2013	67372	ELEM TEACHER	Certificated	T02	05	P	A	1.00	42,204	1.00	42,509
EDN100/DB	7/24/2013	64687	ELEM TEACHER	Certificated	T02	05	T	N			1.00	42,509
EDN100/AA	7/24/2013	66560	ELEM TEACHER	Certificated	T02	05	P	A	1.00	42,204	1.00	42,509
EDN100/AA	7/24/2013	66870	SECONDARY TEACHER	Certificated	T02	05	P	A	1.00	42,204	1.00	42,509
EDN150/FA	7/24/2013	73368	SPEC ED TEACHER	Certificated	T02	05	P	A	1.00	40,381	1.00	42,509
EDN100/AA	7/24/2013	66206	SECONDARY TEACHER	Certificated	T02	05	P	A	1.00	43,182	1.00	42,509
EDN100/AA	7/24/2013	67263	SECONDARY TEACHER	Certificated	T02	05	P	A	1.00	42,204	1.00	42,509
EDN100/AA	7/24/2013	64784	SECONDARY TEACHER	Certificated	T02	05	P	A	1.00	42,204	1.00	42,509
EDN100/AA	7/24/2013	68120	ELEM TEACHER	Certificated	T02	05	P	A	1.00	45,579	1.00	42,509
EDN150/FA	7/24/2013	75927	GEN EDUC/ARTICLE VI TCHR	Certificated	T02	05	P	A	1.00	40,285	1.00	42,509
EDN100/AA	7/24/2013	65275	SECONDARY TEACHER	Certificated	T02	05	P	A	1.00	67,863	1.00	42,509
EDN100/AA	7/24/2013	600503	SECONDARY TEACHER	Certificated	T02	05	T	A	1.00	49,622	1.00	42,509
EDN150/FA	7/24/2013	603475	SPEC ED TEACHER	Certificated	T02	05	T	A			1.00	42,509
EDN150/FA	7/24/2013	60117	GEN EDUC/ARTICLE VI TCHR	Certificated	T02	05	P	A	1.00	40,285	1.00	42,509
EDN100/AA	7/24/2013	61498	ELEM TEACHER	Certificated	T02	05	P	A	1.00	42,204	1.00	42,509
EDN150/FA	7/24/2013	74641	SPEC ED TEACHER	Certificated	T02	05	P	A	1.00	40,381	1.00	42,509
EDN100/AA	7/24/2013	63235	SECONDARY TEACHER	Certificated	T02	05	P	A	1.00	42,204	1.00	42,509
EDN100/AA	7/24/2013	63029	SECONDARY TEACHER	Certificated	T02	05	P	A	1.00	61,168	1.00	42,509
EDN150/FA	7/24/2013	75953	GEN EDUC/ARTICLE VI TCHR	Certificated	T02	05	P	A	1.00	43,785	1.00	42,509
EDN100/AA	7/24/2013	72693	SECONDARY TEACHER	Certificated	T02	05	P	A	1.00	47,403	1.00	42,509
EDN150/FA	7/24/2013	71103	SPEC ED TCHR/PRE-SCHOOL	Certificated	T02	05	P	A			1.00	42,509
EDN100/AA	7/24/2013	601029	ELEM TEACHER	Certificated	T02	05	T	A	1.00	42,204	1.00	42,509
EDN100/AA	7/24/2013	61771	ELEM TEACHER	Certificated	T02	05	T	A	1.00	42,204	1.00	42,509
EDN150/FA	7/24/2013	600194	SPEC ED TCHR/PRE-SCHOOL	Certificated	T02	05	T	A	1.00	40,381	1.00	42,509
EDN150/FA	7/24/2013	74072	SPEC ED TEACHER	Certificated	T02	05	P	A	1.00	40,381	1.00	42,509
EDN100/AA	7/24/2013	66343	ELEM TEACHER	Certificated	T02	05	P	A	1.00	70,911	1.00	42,509
EDN150/FA	7/24/2013	71189	SPEC ED TEACHER	Certificated	T02	05	P	A	1.00	52,000	1.00	42,509
EDN100/AA	7/24/2013	602483	ELEM TEACHER	Certificated	T02	05	T	A			1.00	42,509
EDN100/AA	7/24/2013	602725	ELEM TEACHER	Certificated	T02	05	T	A			1.00	42,509
EDN150/FA	7/24/2013	73471	SPEC ED TEACHER	Certificated	T02	05	P	A	1.00	55,245	1.00	42,509
EDN100/AA	7/24/2013	602848	SECONDARY TEACHER	Certificated	T02	05	T	A			1.00	42,509
EDN100/AA	7/24/2013	62518	ELEM TEACHER	Certificated	T02	05	P	A	1.00	42,204	1.00	42,509
EDN150/FA	7/24/2013	68791	SPEC ED TEACHER	Certificated	T02	05	P	A	1.00	40,381	1.00	42,509
EDN100/AA	7/24/2013	68353	ELEM TEACHER	Certificated	T02	05	T	A	1.00	46,948	1.00	42,509
EDN100/AA	7/24/2013	602438	SECONDARY TEACHER	Certificated	T02	05	T	A	1.00	42,204	1.00	42,509
EDN150/FA	7/24/2013	74041	GEN EDUC/ARTICLE VI TCHR	Certificated	T02	05	T	A	1.00	40,285	1.00	42,509
EDN100/AA	7/24/2013	603646	ELEM TEACHER	Certificated	T02	05	T	A			1.00	42,509
EDN150/FA	7/24/2013	73369	SPEC ED TEACHER	Certificated	T02	05	P	A	1.00	40,381	1.00	42,509
EDN150/FA	7/24/2013	73673	SPEC ED TEACHER	Certificated	T02	05	T	A	1.00	43,611	1.00	42,509
EDN150/FA	7/24/2013	68681	SPEC ED TEACHER	Certificated	T02	05	T	A	1.00	40,381	1.00	42,509
EDN100/AA	7/24/2013	60331	ELEM TEACHER	Certificated	T02	05	P	A	1.00	50,290	1.00	42,509

<u>Prog ID/Org</u>	<u>Separation Date</u>	<u>Position Number</u>	<u>Position Title</u>	<u>Exempt (Y/N)</u>	<u>SR Level</u>	<u>BU Code</u>	<u>T/P</u>	<u>MOF</u>	<u>Budgeted FTE</u>	<u>Budgeted Salary</u>	<u>Actual FTE</u>	<u>Actual Salary</u>
EDN150/FA	7/24/2013	65453	GEN EDUC/ARTICLE VI TCHR	Certificated	T02	05	P	A	1.00	43,507	1.00	42,509
EDN100/AA	7/24/2013	74014	ELEM TEACHER	Certificated	T02	05	T	A	1.00	50,290	1.00	42,509
EDN150/FA	7/24/2013	603209	SPEC ED TEACHER	Certificated	T02	05	T	A			1.00	42,509
EDN100/AA	7/24/2013	68538	ELEM TEACHER	Certificated	T02	05	P	A	1.00	51,798	1.00	42,509
EDN150/FA	7/24/2013	63201	SPEC ED TEACHER	Certificated	T02	05	P	A	1.00	48,118	1.00	42,509
EDN150/FA	7/24/2013	603189	GEN EDUC/ARTICLE VI TCHR	Certificated	T02	05	T	A			1.00	42,509
EDN150/FA	7/24/2013	66557	GEN EDUC/ARTICLE VI TCHR	Certificated	T02	05	P	A	1.00	55,035	1.00	42,509
EDN150/FA	7/24/2013	66399	SPEC ED TEACHER	Certificated	T02	05	P	A	1.00	40,381	1.00	42,509
EDN150/NB	7/24/2013	79872	DIST OFF TCHR	Certificated	T02	05	T	N			1.00	42,509
EDN100/AA	7/24/2013	68012	SECONDARY TEACHER	Certificated	T02	05	P	A	1.00	42,204	1.00	42,509
EDN100/AA	7/24/2013	63368	ELEM TEACHER	Certificated	T02	05	P	A	1.00	45,579	1.00	42,509
EDN150/FA	7/24/2013	62153	SPEC ED TEACHER	Certificated	T02	05	P	A	1.00	30,609	1.00	42,509
EDN100/AA	7/24/2013	61152	ELEM TEACHER	Certificated	T02	05	P	A	1.00	57,292	1.00	42,509
EDN100/AA	7/24/2013	66756	ELEM TEACHER	Certificated	T02	05	P	A	1.00	46,948	1.00	42,509
EDN100/AA	7/24/2013	62199	SECONDARY TEACHER	Certificated	T02	05	P	A	1.00	56,509	1.00	42,509
EDN150/FA	7/24/2013	603518	SPEC ED TEACHER	Certificated	T02	05	T	A			1.00	42,509
EDN150/FA	7/24/2013	76021	SPEC ED TEACHER	Certificated	T02	05	P	A	1.00	40,381	1.00	43,157
EDN100/AA	7/24/2013	73540	SECONDARY TEACHER	Certificated	T02	05	P	A	1.00	42,204	1.00	43,759
EDN100/AA	7/24/2013	603527	ELEM TEACHER	Certificated	T02	05	P	A			1.00	43,759
EDN150/FA	7/24/2013	64506	SPEC ED TEACHER	Certificated	T02	05	P	A	1.00	41,593	1.00	43,785
EDN150/FA	7/24/2013	75513	SPEC ED TCHR/PRE-SCHOOL	Certificated	T02	05	T	A	1.00	41,593	1.00	43,785
EDN100/AA	7/24/2013	602726	ELEM TEACHER	Certificated	T02	05	T	A			1.00	43,785
EDN150/FA	7/24/2013	71786	GEN EDUC/ARTICLE VI TCHR	Certificated	T02	05	P	A	1.00	57,297	1.00	43,785
EDN100/AA	7/24/2013	63089	ELEM TEACHER	Certificated	T02	05	P	A	1.00	43,470	1.00	43,785
EDN100/AA	7/24/2013	66463	ELEM TEACHER	Certificated	T02	05	T	A	1.00	44,736	1.00	43,785
EDN150/FA	7/24/2013	67600	SPEC ED TEACHER	Certificated	T02	05	P	A	1.00	43,611	1.00	43,785
EDN150/FA	7/24/2013	71789	SPEC ED TEACHER	Certificated	T02	05	P	A	1.00	42,840	1.00	45,098
EDN100/AA	7/24/2013	61240	ELEM TEACHER	Certificated	T02	05	P	A	1.00	45,796	1.00	45,098
EDN150/FA	7/24/2013	65072	SPEC ED TEACHER	Certificated	T02	05	P	A	1.00	42,840	1.00	45,098
EDN100/AA	7/24/2013	61957	SECONDARY TEACHER	Certificated	T02	05	P	A	1.00	44,774	1.00	45,098
EDN100/AA	7/24/2013	64958	SECONDARY TEACHER	Certificated	T02	05	P	A	1.00	49,663	1.00	45,098
EDN100/AA	7/24/2013	72354	ELEM TEACHER	Certificated	T02	05	T	A	1.00	45,796	1.00	45,098
EDN100/AA	7/24/2013	63011	ELEM TEACHER	Certificated	T02	05	P	A	1.00	44,774	1.00	45,098
EDN100/BJ	7/24/2013	73076	DIST OFF TCHR	Certificated	T02	05	P	A			1.00	45,098
EDN100/AA	7/24/2013	63271	SECONDARY TEACHER	Certificated	T02	05	P	A	1.00	44,774	1.00	45,098
EDN100/AA	7/24/2013	63544	ELEM TEACHER	Certificated	T02	05	P	A	1.00	44,774	1.00	45,098
EDN100/AA	7/24/2013	68026	SECONDARY TEACHER	Certificated	T02	05	P	A	1.00	44,774	1.00	45,098
EDN150/FA	7/24/2013	60204	GEN EDUC/ARTICLE VI TCHR	Certificated	T02	05	P	A	1.00	40,285	1.00	45,098
EDN100/AA	7/24/2013	60845	ELEM TEACHER	Certificated	T02	05	P	A	1.00	44,774	1.00	45,098
EDN100/AA	7/24/2013	66310	ELEM TEACHER	Certificated	T02	05	T	A	1.00	44,774	1.00	45,098
EDN100/AA	7/24/2013	60221	ELEM TEACHER	Certificated	T02	05	P	A	1.00	44,774	1.00	45,098
EDN150/FA	7/24/2013	66083	SPEC ED TEACHER	Certificated	T02	05	P	A	1.00	42,840	1.00	45,098
EDN100/AA	7/24/2013	71769	ELEM TEACHER	Certificated	T03	05	P	A	1.00	45,579	1.00	45,909
EDN100/AA	7/24/2013	67729	SECONDARY TEACHER	Certificated	T03	05	P	A	1.00	59,283	1.00	45,909
EDN150/FA	7/24/2013	603190	GEN EDUC/ARTICLE VI TCHR	Certificated	T03	05	T	A			1.00	45,909

Department of Education
Personnel Separations

Table 15

<u>Prog ID/Org</u>	<u>Separation Date</u>	<u>Position Number</u>	<u>Position Title</u>	<u>Exempt (Y/N)</u>	<u>SR Level</u>	<u>BU Code</u>	<u>T/P</u>	<u>MOF</u>	<u>Budgeted FTE</u>	<u>Budgeted Salary</u>	<u>Actual FTE</u>	<u>Actual Salary</u>
EDN150/FA	7/24/2013	603291	SPEC ED TEACHER	Certificated	T03	05	T	A			1.00	45,909
EDN100/AA	7/24/2013	71822	SECONDARY TEACHER	Certificated	T03	05	T	A	1.00	46,601	1.00	45,909
EDN150/FA	7/24/2013	602023	SPEC ED TEACHER	Certificated	T03	05	T	A	1.00	44,823	1.00	45,909
EDN100/AA	7/24/2013	66170	SECONDARY TEACHER	Certificated	T03	05	P	A	1.00	45,579	1.00	45,909
EDN100/AA	7/24/2013	69881	COUNSELOR	Certificated	T03	05	T	A	0.50	22,789	1.00	45,909
EDN100/AA	7/24/2013	74763	SECONDARY TEACHER	Certificated	T03	05	T	A	1.00	45,579	1.00	45,909
EDN100/AA	7/24/2013	603432	SECONDARY TEACHER	Certificated	T03	05	T	A			1.00	45,909
EDN100/AA	7/24/2013	69195	SECONDARY TEACHER	Certificated	T03	05	P	A	1.00	45,579	1.00	45,909
EDN100/AA	7/24/2013	602754	ELEM TEACHER	Certificated	T03	05	T	A			1.00	45,909
EDN100/AA	7/24/2013	74264	SECONDARY TEACHER	Certificated	T03	05	T	A	1.00	45,579	1.00	45,909
EDN150/FA	7/24/2013	603224	SPEC ED TEACHER	Certificated	T03	05	T	A			1.00	45,909
EDN100/AA	7/24/2013	71399	COUNSELOR	Certificated	T03	05	T	A	1.00	45,579	1.00	45,909
EDN100/AA	7/24/2013	600809	ELEM TEACHER	Certificated	T03	05	T	A	1.00	42,204	1.00	45,909
EDN100/AA	7/24/2013	602747	SECONDARY TEACHER	Certificated	T03	05	T	A			1.00	45,909
EDN100/AA	7/24/2013	72026	SECONDARY TEACHER	Certificated	T03	05	P	A	1.00	45,579	1.00	45,909
EDN100/AA	7/24/2013	603387	SECONDARY TEACHER	Certificated	T03	05	T	A			1.00	45,909
EDN100/AA	7/24/2013	69521	SECONDARY TEACHER	Certificated	T03	05	P	A	1.00	51,556	1.00	45,909
EDN100/AA	7/24/2013	61651	ELEM TEACHER	Certificated	T03	05	T	A	1.00	39,671	1.00	45,909
EDN100/AA	7/24/2013	73197	SECONDARY TEACHER	Certificated	T03	05	T	A	1.00	39,670	1.00	45,909
EDN150/FA	7/24/2013	600146	GEN EDUC/ARTICLE VI TCHR	Certificated	T03	05	T	A	1.00	37,867	1.00	45,909
EDN150/FA	7/24/2013	68387	SPEC ED TEACHER	Certificated	T03	05	T	A	1.00	43,611	1.00	45,909
EDN100/AA	7/24/2013	67258	ELEM TEACHER	Certificated	T03	05	P	A	1.00	61,851	1.00	45,909
EDN150/FA	7/24/2013	68527	SPEC ED TEACHER	Certificated	T03	05	P	A	1.00	46,717	1.00	45,909
EDN100/AA	7/24/2013	602120	ELEM TEACHER	Certificated	T03	05	T	A	1.00	45,579	1.00	45,909
EDN100/AA	7/24/2013	68331	SECONDARY TEACHER	Certificated	T03	05	P	A	1.00	39,671	1.00	45,909
EDN150/FA	7/24/2013	65034	SPEC ED TEACHER	Certificated	T03	05	T	A	1.00	55,167	1.00	45,909
EDN100/AA	7/24/2013	68703	SECONDARY TEACHER	Certificated	T03	05	T	A	1.00	45,579	1.00	45,909
EDN100/AA	7/24/2013	73058	ELEM TEACHER	Certificated	T03	05	T	A	1.00	56,025	1.00	45,909
EDN100/AA	7/24/2013	64579	SECONDARY TEACHER	Certificated	T03	05	P	A	1.00	45,579	1.00	45,909
EDN150/FA	7/24/2013	600173	SPEC ED TEACHER	Certificated	T03	05	T	A	1.00	43,611	1.00	45,909
EDN100/AA	7/24/2013	64369	SECONDARY TEACHER	Certificated	T03	05	P	A	1.00	46,846	1.00	45,909
EDN100/AA	7/24/2013	603342	SECONDARY TEACHER	Certificated	T03	05	T	N			1.00	45,909
EDN100/AA	7/24/2013	68675	SECONDARY TEACHER	Certificated	T03	05	T	A	1.00	39,671	1.00	45,909
EDN150/FA	7/24/2013	75929	GEN EDUC/ARTICLE VI TCHR	Certificated	T03	05	P	A	1.00	37,867	1.00	45,909
EDN100/BV	7/24/2013	74207	ELEM TEACHER	Certificated	T03	05	T	A	1.00	57,646	1.00	45,909
EDN150/FA	7/24/2013	600737	SPEC ED TEACHER	Certificated	T03	05	T	A	1.00	48,118	1.00	45,909
EDN150/FA	7/24/2013	73672	SPEC ED TEACHER	Certificated	T03	05	T	A			1.00	45,909
EDN100/AA	7/24/2013	71083	ELEM TEACHER	Certificated	T03	05	P	A	1.00	45,579	1.00	45,909
EDN100/AA	7/24/2013	63817	SECONDARY TEACHER	Certificated	T03	05	P	A	1.00	31,990	1.00	45,909
EDN100/AA	7/24/2013	65705	ELEM TEACHER	Certificated	T03	05	P	A	1.00	48,356	1.00	45,909
EDN150/FA	7/24/2013	73916	SPEC ED TEACHER	Certificated	T03	05	P	A	1.00	48,118	1.00	45,909
EDN150/FA	7/24/2013	71365	GEN EDUC/ARTICLE VI TCHR	Certificated	T03	05	P	A	1.00	51,421	1.00	45,909
EDN150/FA	7/24/2013	64292	SPEC ED TEACHER	Certificated	T03	05	P	A	1.00	43,611	1.00	45,909
EDN100/AA	7/24/2013	63122	ELEM TEACHER	Certificated	T03	05	P	A	1.00	42,844	1.00	45,909
EDN100/AA	7/24/2013	66596	ELEM TEACHER	Certificated	T03	05	P	A	1.00	63,004	1.00	45,909

Department of Education
Personnel Separations

Table 15

<u>Prog ID/Org</u>	<u>Separation Date</u>	<u>Position Number</u>	<u>Position Title</u>	<u>Exempt (Y/N)</u>	<u>SR Level</u>	<u>BU Code</u>	<u>T/P</u>	<u>MOF</u>	<u>Budgeted FTE</u>	<u>Budgeted Salary</u>	<u>Actual FTE</u>	<u>Actual Salary</u>
EDN100/AA	7/24/2013	601427	SECONDARY TEACHER	Certificated	T03	05	T	A	1.00	42,204	1.00	45,909
EDN100/AA	7/24/2013	603423	ELEM TEACHER	Certificated	T03	05	T	A			1.00	45,909
EDN100/AA	7/24/2013	72276	ELEM TEACHER	Certificated	T03	05	P	A	1.00	45,579	1.00	45,909
EDN100/AA	7/24/2013	61063	ELEM TEACHER	Certificated	T03	05	P	A	1.00	45,579	1.00	45,909
EDN100/AA	7/24/2013	602512	ELEM TEACHER	Certificated	T03	05	T	A			1.00	45,909
EDN100/AA	7/24/2013	600822	ELEM TEACHER	Certificated	T03	05	T	A	1.00	45,579	1.00	45,909
EDN150/FA	7/24/2013	600521	GEN EDUC/ARTICLE VI TCHR	Certificated	T03	05	T	A	1.00	43,507	1.00	45,909
EDN100/AA	7/24/2013	61409	ELEM TEACHER	Certificated	T03	05	T	A	1.00	39,671	1.00	45,909
EDN150/FA	7/24/2013	75928	GEN EDUC/ARTICLE VI TCHR	Certificated	T03	05	P	A	1.00	37,867	1.00	45,909
EDN100/AA	7/24/2013	65092	ELEM TEACHER	Certificated	T03	05	P	A	1.00	45,579	1.00	45,909
EDN100/AA	7/24/2013	65799	SECONDARY TEACHER	Certificated	T03	05	P	A	1.00	45,579	1.00	45,909
EDN100/DB	7/24/2013	602616	SECONDARY TEACHER	Certificated	T03	05	T	N			1.00	45,909
EDN100/AA	7/24/2013	62852	SECONDARY TEACHER	Certificated	T03	05	P	A	1.00	39,671	1.00	45,909
EDN100/AA	7/24/2013	600432	ELEM TEACHER	Certificated	T03	05	T	A	1.00	39,671	1.00	45,909
EDN150/FA	7/24/2013	75266	SPEC ED TEACHER	Certificated	T03	05	P	A	1.00	44,920	1.00	45,909
EDN100/AA	7/24/2013	64532	SECONDARY TEACHER	Certificated	T03	05	T	A	1.00	46,948	1.00	45,909
EDN100/AA	7/24/2013	63777	SECONDARY TEACHER	Certificated	T03	05	P	A	1.00	39,671	1.00	45,909
EDN100/AA	7/24/2013	601889	SECONDARY TEACHER	Certificated	T03	05	T	A	1.00	39,671	1.00	45,909
EDN150/FA	7/24/2013	67383	SPEC ED TEACHER	Certificated	T03	05	P	A	1.00	37,958	1.00	45,909
EDN100/AA	7/24/2013	72152	SECONDARY TEACHER	Certificated	T03	05	P	A	1.00	51,301	1.00	45,909
EDN100/AA	7/24/2013	603383	ELEM TEACHER	Certificated	T03	05	T	A			1.00	45,909
EDN150/FA	7/24/2013	601895	SPEC ED TEACHER	Certificated	T03	05	T	A	1.00	43,611	1.00	45,909
EDN100/AA	7/24/2013	600700	ELEM TEACHER	Certificated	T03	05	T	A	1.00	45,579	1.00	45,909
EDN100/AA	7/24/2013	68857	SECONDARY TEACHER	Certificated	T03	05	P	A	1.00	45,579	1.00	45,909
EDN100/AA	7/24/2013	62330	SECONDARY TEACHER	Certificated	T03	05	P	A	1.00	39,671	1.00	45,909
EDN150/FA	7/24/2013	76160	SPEC ED TEACHER	Certificated	T03	05	P	A	1.00	43,611	1.00	45,909
EDN100/AA	7/24/2013	64591	SECONDARY TEACHER	Certificated	T03	05	P	A	1.00	39,671	1.00	45,909
EDN150/FA	7/24/2013	602097	SPEC ED TEACHER	Certificated	T03	05	T	A	1.00	43,611	1.00	45,909
EDN100/AA	7/24/2013	600430	ELEM TEACHER	Certificated	T03	05	T	A	1.00	63,004	1.00	45,909
EDN100/AA	7/24/2013	601934	ELEM TEACHER	Certificated	T03	05	T	A	1.00	45,579	1.00	45,909
EDN100/AA	7/24/2013	62895	SECONDARY TEACHER	Certificated	T03	05	T	A	1.00	39,671	1.00	45,909
EDN100/AA	7/24/2013	75321	COUNSELOR	Certificated	T03	05	T	A	1.00	52,302	1.00	45,909
EDN100/AA	7/24/2013	601918	ELEM TEACHER	Certificated	T03	05	T	A	1.00	57,657	1.00	45,909
EDN100/AA	7/24/2013	72363	SECONDARY TEACHER	Certificated	T03	05	P	A	1.00	45,579	1.00	45,909
EDN100/AA	7/24/2013	60961	SECONDARY TEACHER	Certificated	T03	05	P	A	1.00	48,670	1.00	45,909
EDN150/FA	7/24/2013	603627	SPEC ED TEACHER	Certificated	T03	05	T	A			1.00	45,909
EDN150/NB	7/24/2013	600815	DIST OFF TCHR	Certificated	T03	05	T	N			1.00	45,909
EDN150/FA	7/24/2013	64365	GEN EDUC/ARTICLE VI TCHR	Certificated	T03	05	P	A	1.00	46,157	1.00	45,909
EDN100/AA	7/24/2013	603597	ELEM TEACHER	Certificated	T03	05	T	A			1.00	45,909
EDN100/AA	7/24/2013	64016	ELEM TEACHER	Certificated	T03	05	P	A	1.00	52,302	1.00	45,909
EDN100/AA	7/24/2013	72106	SECONDARY TEACHER	Certificated	T03	05	P	A	1.00	51,271	1.00	45,909
EDN150/FA	7/24/2013	602485	SPEC ED TCHR/PRE-SCHOOL	Certificated	T03	05	T	A	1.00	43,611	1.00	45,909
EDN100/AA	7/24/2013	60647	ELEM TEACHER	Certificated	T03	05	P	A	1.00	60,409	1.00	45,909
EDN100/AA	7/24/2013	62106	SECONDARY TEACHER	Certificated	T03	05	T	A	1.00	45,579	1.00	45,909
EDN150/FA	7/24/2013	73295	SPEC ED TEACHER	Certificated	T03	05	P	A	1.00	43,611	1.00	45,909

Department of Education
Personnel Separations

Table 15

<u>Prog ID/Org</u>	<u>Separation Date</u>	<u>Position Number</u>	<u>Position Title</u>	<u>Exempt (Y/N)</u>	<u>SR Level</u>	<u>BU Code</u>	<u>T/P</u>	<u>MOF</u>	<u>Budgeted FTE</u>	<u>Budgeted Salary</u>	<u>Actual FTE</u>	<u>Actual Salary</u>
EDN150/FA	7/24/2013	601667	SPEC ED TEACHER	Certificated	T03	05	T	A	1.00	43,611	1.00	45,909
EDN100/AA	7/24/2013	601441	ELEM TEACHER	Certificated	T03	05	T	A	1.00	46,948	1.00	45,909
EDN100/AA	7/24/2013	65547	SECONDARY TEACHER	Certificated	T03	05	P	A	1.00	45,579	1.00	45,909
EDN100/AA	7/24/2013	603589	ELEM TEACHER	Certificated	T03	05	T	A			1.00	45,909
EDN150/FA	7/24/2013	74077	SPEC ED TEACHER	Certificated	T03	05	P	A			1.00	45,909
EDN150/FA	7/24/2013	76013	SPEC ED TEACHER	Certificated	T03	05	P	A	1.00	43,611	1.00	45,909
EDN150/FA	7/24/2013	602255	SPEC ED TEACHER	Certificated	T03	05	T	A			1.00	45,909
EDN100/AA	7/24/2013	68986	SECONDARY TEACHER	Certificated	T03	05	P	A	1.00	45,579	1.00	45,909
EDN100/AA	7/24/2013	62118	ELEM TEACHER	Certificated	T03	05	P	A	1.00	45,579	1.00	45,909
EDN150/FA	7/24/2013	67247	GEN EDUC/ARTICLE VI TCHR	Certificated	T03	05	P	A	1.00	49,545	1.00	45,909
EDN150/FA	7/24/2013	63640	SPEC ED TEACHER	Certificated	T03	05	T	A	1.00	43,611	1.00	45,909
EDN150/NB	7/24/2013	79776	DIST OFF TCHR	Certificated	T03	05	T	N			1.00	45,909
EDN150/FA	7/24/2013	603315	SPEC ED TEACHER	Certificated	T03	05	T	A			1.00	45,909
EDN150/FA	7/24/2013	600174	SPEC ED TEACHER	Certificated	T03	05	T	A	1.00	40,381	1.00	45,909
EDN100/AA	7/24/2013	600640	ELEM TEACHER	Certificated	T03	05	T	A	1.00	39,671	1.00	45,909
EDN100/BJ	7/24/2013	66179	SECONDARY TEACHER	Certificated	T03	05	T	A			1.00	45,909
EDN100/AA	7/24/2013	601081	SPEC ED TEACHER	Certificated	T03	05	T	A	1.00	42,204	1.00	45,909
EDN150/FA	7/24/2013	62681	SPEC ED TEACHER	Certificated	T03	05	P	A	1.00	43,611	1.00	45,909
EDN100/AA	7/24/2013	603606	ELEM TEACHER	Certificated	T03	05	T	A			1.00	45,909
EDN150/FA	7/24/2013	63086	SPEC ED TEACHER	Certificated	T03	05	P	A	1.00	50,043	1.00	45,909
EDN150/FA	7/24/2013	603558	GEN EDUC/ARTICLE VI TCHR	Certificated	T03	05	T	A			1.00	45,909
EDN150/FA	7/24/2013	603213	GEN EDUC/ARTICLE VI TCHR	Certificated	T03	05	T	A			1.00	45,909
EDN100/AA	7/24/2013	68092	ELEM TEACHER	Certificated	T03	05	P	A	1.00	45,579	1.00	45,909
EDN150/FA	7/24/2013	66399	SPEC ED TEACHER	Certificated	T03	05	P	A	1.00	40,381	1.00	45,909
EDN150/FA	7/24/2013	603713	SPEC ED TEACHER	Certificated	T03	05	T	A			1.00	45,909
EDN100/AA	7/24/2013	66184	COUNSELOR	Certificated	T03	05	P	A	1.00	45,579	1.00	45,909
EDN150/FA	7/24/2013	65829	SPEC ED TEACHER	Certificated	T03	05	P	A	1.00	43,611	1.00	45,909
EDN150/FA	7/24/2013	603206	GEN EDUC/ARTICLE VI TCHR	Certificated	T03	05	T	A			1.00	45,909
EDN150/FA	7/24/2013	72250	SPEC ED TEACHER	Certificated	T03	05	P	A	1.00	43,611	1.00	45,909
EDN150/FA	7/24/2013	74080	SPEC ED TEACHER	Certificated	T03	05	P	A			1.00	45,909
EDN100/AA	7/24/2013	66980	SECONDARY TEACHER	Certificated	T03	05	P	A	0.50	15,995	1.00	45,909
EDN150/FA	7/24/2013	68249	GEN EDUC/ARTICLE VI TCHR	Certificated	T03	05	P	A	1.00	43,507	1.00	45,909
EDN100/AA	7/24/2013	603699	SECONDARY TEACHER	Certificated	T03	05	T	A			1.00	45,909
EDN150/FA	7/24/2013	74036	GEN EDUC/ARTICLE VI TCHR	Certificated	T03	05	P	A	1.00	45,341	1.00	45,909
EDN150/FA	7/24/2013	600377	SPEC ED TEACHER	Certificated	T03	05	T	A	1.00	43,611	1.00	45,909
EDN100/AA	7/24/2013	62573	SECONDARY TEACHER	Certificated	T03	05	P	A	1.00	73,038	1.00	45,909
EDN150/FA	7/24/2013	61151	SPEC ED TCHR/PRE-SCHOOL	Certificated	T03	05	P	A	1.00	56,379	1.00	45,909
EDN100/AA	7/24/2013	68893	SECONDARY TEACHER	Certificated	T03	05	P	A	1.00	46,601	1.00	46,609
EDN100/AA	7/24/2013	63366	ELEM TEACHER	Certificated	T03	05	P	A	1.00	46,948	1.00	47,287
EDN100/AA	7/24/2013	68426	SECONDARY TEACHER	Certificated	T03	05	P	A	1.00	47,969	1.00	47,287
EDN100/AA	7/24/2013	67636	ELEM TEACHER	Certificated	T03	05	P	A	1.00	42,204	1.00	47,287
EDN150/FA	7/24/2013	67960	SPEC ED TEACHER	Certificated	T03	05	P	A	1.00	50,043	1.00	47,287
EDN100/AA	7/24/2013	66675	ELEM TEACHER	Certificated	T03	05	P	A	1.00	47,969	1.00	47,287
EDN100/DB	7/24/2013	602328	SECONDARY TEACHER	Certificated	T03	05	T	N			1.00	47,287
EDN100/AA	7/24/2013	75331	COUNSELOR/HIGH RISK	Certificated	T03	05	P	A	1.00	47,969	1.00	47,287

<u>Prog ID/Org</u>	<u>Separation Date</u>	<u>Position Number</u>	<u>Position Title</u>	<u>Exempt (Y/N)</u>	<u>SR Level</u>	<u>BU Code</u>	<u>T/P</u>	<u>MOF</u>	<u>Budgeted FTE</u>	<u>Budgeted Salary</u>	<u>Actual FTE</u>	<u>Actual Salary</u>
EDN150/FA	7/24/2013	64822	SPEC ED TEACHER	Certificated	T03	05	P	A	1.00	44,920	1.00	47,287
EDN150/FA	7/24/2013	74172	SPEC ED TEACHER	Certificated	T03	05	P	A	1.00	44,920	1.00	47,287
EDN100/AA	7/24/2013	601434	SECONDARY TEACHER	Certificated	T03	05	T	A	1.00	46,948	1.00	47,287
EDN150/FA	7/24/2013	64129	SPEC ED TEACHER	Certificated	T03	05	P	A	1.00	44,920	1.00	47,287
EDN100/AA	7/24/2013	68581	SECONDARY TEACHER	Certificated	T03	05	P	A	1.00	46,948	1.00	47,287
EDN100/AA	7/24/2013	63703	SECONDARY TEACHER	Certificated	T03	05	P	A	1.00	46,948	1.00	47,287
EDN100/AA	7/24/2013	69872	ELEM TEACHER	Certificated	T03	05	P	A	1.00	48,356	1.00	47,287
EDN100/AA	7/24/2013	601181	ELEM TEACHER	Certificated	T03	05	T	A	1.00	46,948	1.00	47,287
EDN150/FA	7/24/2013	600097	SPEC ED TEACHER	Certificated	T03	05	T	A	1.00	46,132	1.00	47,287
EDN150/FA	7/24/2013	73215	SPEC ED TEACHER	Certificated	T03	05	P	A	1.00	44,920	1.00	47,287
EDN150/FA	7/24/2013	69436	SPEC ED TEACHER	Certificated	T03	05	P	A	1.00	48,118	1.00	47,287
EDN100/AA	7/24/2013	74559	ELEM TEACHER	Certificated	T03	05	P	A	1.00	46,948	1.00	47,287
EDN100/AA	7/24/2013	62558	SECONDARY TEACHER	Certificated	T03	05	P	A	1.00	45,579	1.00	47,287
EDN100/AA	7/24/2013	64368	ELEM TEACHER	Certificated	T03	05	P	A	1.00	46,948	1.00	47,287
EDN100/AA	7/24/2013	65526	ELEM TEACHER	Certificated	T03	05	T	A	1.00	47,969	1.00	47,287
EDN150/FA	7/24/2013	601766	SPEC ED TEACHER	Certificated	T03	05	T	A			1.00	47,287
EDN100/AA	7/24/2013	68502	ELEM TEACHER	Certificated	T03	05	P	A	1.00	46,948	1.00	47,287
EDN100/AA	7/24/2013	73172	ELEM TEACHER	Certificated	T03	05	T	A	1.00	49,298	1.00	47,287
EDN100/AA	7/24/2013	600710	ELEM TEACHER	Certificated	T03	05	T	A			1.00	47,287
EDN100/AA	7/24/2013	64971	SECONDARY TEACHER	Certificated	T03	05	P	A	1.00	73,038	1.00	47,287
EDN150/FA	7/24/2013	63003	SPEC ED TEACHER	Certificated	T04	05	P	A	1.00	43,611	1.00	47,746
EDN100/AA	7/24/2013	601630	10-MO STUDENT SVCS COORD	Certificated	T04	05	T	A	1.00	45,579	1.00	47,746
EDN150/FA	7/24/2013	60285	SPEC ED TEACHER	Certificated	T04	05	P	A	1.00	45,356	1.00	47,746
EDN150/FA	7/24/2013	72144	SPEC ED TCHR/PRE-SCHOOL	Certificated	T04	05	P	A	1.00	40,381	1.00	47,746
EDN150/FA	7/24/2013	603321	SPEC ED TEACHER	Certificated	T03	05	T	A			1.00	48,706
EDN150/FA	7/24/2013	69148	SPEC ED TEACHER	Certificated	T03	05	P	A	1.00	46,268	1.00	48,706
EDN100/AA	7/24/2013	65801	SECONDARY TEACHER	Certificated	T03	05	P	A	1.00	48,356	1.00	48,706
EDN100/AA	7/24/2013	66570	ELEM TEACHER	Certificated	T03	05	P	A	1.00	61,168	1.00	48,706
EDN100/AA	7/24/2013	64807	SECONDARY TEACHER	Certificated	T03	05	P	A	1.00	49,622	1.00	48,706
EDN150/FA	7/24/2013	64618	SPEC ED TEACHER	Certificated	T03	05	P	A	1.00	46,268	1.00	48,706
EDN100/AA	7/24/2013	60964	SECONDARY TEACHER	Certificated	T03	05	P	A	1.00	48,356	1.00	48,706
EDN150/FA	7/24/2013	69214	SPEC ED TEACHER	Certificated	T03	05	T	A	1.00	46,268	1.00	48,706
EDN150/FA	7/24/2013	69030	SPEC ED TEACHER	Certificated	T03	05	P	A	1.00	50,946	1.00	48,706
EDN100/AA	7/24/2013	67746	ELEM TEACHER	Certificated	T03	05	P	A	1.00	48,356	1.00	48,706
EDN100/AA	7/24/2013	68883	SECONDARY TEACHER	Certificated	T03	05	P	A	1.00	49,378	1.00	48,706
EDN100/AA	7/24/2013	67952	ELEM TEACHER	Certificated	T03	05	T	A	1.00	48,356	1.00	48,706
EDN150/FA	7/24/2013	76071	SPEC ED TEACHER	Certificated	T03	05	P	A	1.00	44,920	1.00	48,706
EDN100/DB	7/24/2013	600255	SPEC ED TEACHER	Certificated	T04	05	T	N			1.00	49,179
EDN100/AA	7/24/2013	65867	SECONDARY TEACHER	Certificated	T04	05	P	A	1.00	48,825	1.00	49,179
EDN150/FA	7/24/2013	68527	SPEC ED TEACHER	Certificated	T04	05	P	A	1.00	46,717	1.00	49,179
EDN150/FA	7/24/2013	73937	SPEC ED TEACHER	Certificated	T05	05	P	A	1.00	46,568	1.00	49,655
EDN100/AA	7/24/2013	72188	ELEM TEACHER	Certificated	T03	05	P	A	1.00	49,806	1.00	50,167
EDN150/FA	7/24/2013	75447	GEN EDUC/ARTICLE VI TCHR	Certificated	T04	05	T	A	1.00	46,157	1.00	50,654
EDN100/AA	7/24/2013	69820	ELEM TEACHER	Certificated	T04	05	T	A	1.00	50,290	1.00	50,654
EDN100/AA	7/24/2013	71335	SECONDARY TEACHER	Certificated	T04	05	P	A	1.00	51,312	1.00	50,654

Department of Education
Personnel Separations

Table 15

<u>Prog ID/Org</u>	<u>Separation Date</u>	<u>Position Number</u>	<u>Position Title</u>	<u>Exempt (Y/N)</u>	<u>SR Level</u>	<u>BU Code</u>	<u>T/P</u>	<u>MOF</u>	<u>Budgeted FTE</u>	<u>Budgeted Salary</u>	<u>Actual FTE</u>	<u>Actual Salary</u>
EDN150/FA	7/24/2013	73678	SPEC ED TCHR/PRE-SCHOOL	Certificated	T04	05	P	A	1.00	48,118	1.00	50,654
EDN100/AA	7/24/2013	68929	SECONDARY TEACHER	Certificated	T04	05	P	A	1.00	51,312	1.00	50,654
EDN100/AA	7/24/2013	602695	ELEM TEACHER	Certificated	T04	05	T	A			1.00	50,654
EDN100/AA	7/24/2013	600771	SECONDARY TEACHER	Certificated	T04	05	T	A	1.00	50,290	1.00	50,654
EDN150/FA	7/24/2013	75729	SPEC ED TCHR/PRE-SCHOOL	Certificated	T04	05	P	A	1.00	46,268	1.00	50,654
EDN150/FA	7/24/2013	75565	GEN EDUC/ARTICLE VI TCHR	Certificated	T04	05	P	A	1.00	48,003	1.00	50,654
EDN150/FA	7/24/2013	75923	GEN EDUC/ARTICLE VI TCHR	Certificated	T04	05	P	A	1.00	48,003	1.00	50,654
EDN150/FA	7/24/2013	600737	SPEC ED TEACHER	Certificated	T04	05	T	A	1.00	48,118	1.00	50,654
EDN100/AA	7/24/2013	69914	SECONDARY TEACHER	Certificated	T04	05	P	A	1.00	51,556	1.00	50,654
EDN150/FA	7/24/2013	74023	SPEC ED TEACHER	Certificated	T04	05	P	A	1.00	46,268	1.00	50,654
EDN100/AA	7/24/2013	68660	ELEM TEACHER	Certificated	T04	05	P	A	1.00	51,556	1.00	50,654
EDN100/AA	7/24/2013	68263	ELEM TEACHER	Certificated	T04	05	P	A	1.00	50,290	1.00	50,654
EDN100/AA	7/24/2013	67208	ELEM TEACHER	Certificated	T05	05	P	A	1.00	50,778	1.00	51,146
EDN100/AA	7/24/2013	71583	ELEM TEACHER	Certificated	T05	05	T	A	1.00	50,778	1.00	51,146
EDN100/AA	7/24/2013	64778	SECONDARY TEACHER	Certificated	T06	05	P	A	1.00	51,271	1.00	51,642
EDN100/AA	7/24/2013	63256	SECONDARY TEACHER	Certificated	T04	05	P	A	1.00	51,556	1.00	52,144
EDN150/FA	7/24/2013	62504	SPEC ED TEACHER	Certificated	T04	05	P	A	1.00	49,561	1.00	52,173
EDN100/AA	7/24/2013	65660	SECONDARY TEACHER	Certificated	T04	05	P	A	1.00	51,798	1.00	52,173
EDN150/FA	7/24/2013	71939	SPEC ED TEACHER	Certificated	T05	05	T	A	1.00	50,043	1.00	52,680
EDN100/AA	7/24/2013	602684	ELEM TEACHER	Certificated	T05	05	T	A			1.00	52,680
EDN100/AA	7/24/2013	64432	COUNSELOR	Certificated	T05	05	P	A	1.00	52,302	1.00	52,680
EDN100/BJ	7/24/2013	73109	SECONDARY TEACHER	Certificated	T05	05	T	A			1.00	52,680
EDN150/FA	7/24/2013	62074	SPEC ED TEACHER	Certificated	T05	05	P	A	1.00	50,043	1.00	52,680
EDN150/FA	7/24/2013	66608	SPEC ED TEACHER	Certificated	T04	05	P	A	1.00	51,049	1.00	53,739
EDN100/AA	7/24/2013	61856	LIBRARIAN	Certificated	T06	05	P	A	1.00	55,660	1.00	54,787
EDN100/AA	7/24/2013	64318	SECONDARY TEACHER	Certificated	T06	05	T	A	1.00	54,393	1.00	54,787
EDN100/AA	7/24/2013	68393	ELEM TEACHER	Certificated	T06	05	P	A	1.00	60,305	1.00	54,787
EDN100/AA	7/24/2013	74245	SECONDARY TEACHER	Certificated	T06	05	P	A	1.00	64,270	1.00	54,787
EDN100/AA	7/24/2013	72676	LIBRARIAN	Certificated	T05	05	P	A	1.00	56,753	1.00	55,888
EDN100/AA	7/24/2013	64362	COUNSELOR	Certificated	T07	05	P	A	1.00	45,579	1.00	56,350
EDN150/FA	7/24/2013	73354	SPEC ED TEACHER	Certificated	T04	05	P	A	1.00	54,157	1.00	57,011
EDN150/FA	7/24/2013	72159	SPEC ED TCHR/PRE-SCHOOL	Certificated	T07	05	P	A	1.00	55,167	1.00	58,074
EDN100/AA	7/24/2013	69633	SECONDARY TEACHER	Certificated	T07	05	P	A	1.00	57,657	1.00	58,074
EDN100/AA	7/24/2013	68456	SECONDARY TEACHER	Certificated	T07	05	T	A	1.00	48,356	1.00	58,074
EDN100/AA	7/24/2013	67940	ELEM TEACHER	Certificated	T07	05	P	A	1.00	57,657	1.00	58,074
EDN150/FA	7/24/2013	66779	GEN EDUC/ARTICLE VI TCHR	Certificated	T07	05	P	A	1.00	55,035	1.00	58,074
EDN150/FA	7/24/2013	75890	GEN EDUC/ARTICLE VI TCHR	Certificated	T07	05	P	A	1.00	55,035	1.00	58,074
EDN100/AA	7/24/2013	61008	SECONDARY TEACHER	Certificated	T07	05	P	A	1.00	59,388	1.00	59,818
EDN100/AA	7/24/2013	63658	ELEM TEACHER	Certificated	T07	05	P	A	1.00	60,409	1.00	59,818
EDN100/AA	7/24/2013	69008	ELEM TEACHER	Certificated	T07	05	P	A	1.00	59,388	1.00	59,818
EDN100/AA	7/24/2013	63811	ELEM TEACHER	Certificated	T07	05	T	A	1.00	61,168	1.00	61,611
EDN150/FA	7/24/2013	72390	SPEC ED TEACHER	Certificated	T07	05	P	A	1.00	62,091	1.00	65,363
EDN150/FA	7/24/2013	73297	SPEC ED TCHR/PRE-SCHOOL	Certificated	T07	05	P	A	1.00	63,955	1.00	67,325
EDN150/FA	7/25/2013	28506	EDUC ASST III	Y	SR12	03	P	A	1.00	24,450	1.00	25,030
EDN100/AA	7/25/2013	72349	SECONDARY TEACHER	Certificated	T03	05	P	A	1.00	45,579	1.00	45,909

Department of Education
Personnel Separations

Table 15

Prog ID/Org	Separation Date	Position Number	Position Title	Exempt (Y/N)	SR Level	BU Code	T/P	MOF	Budgeted FTE	Budgeted Salary	Actual FTE	Actual Salary
EDN150/YC	7/25/2013	58214	CLINICAL PSYCHOLOGIST VI	N	SR26	13	P	A	1.00	60,939	1.00	57,720
EDN400/OC	7/26/2013	37312	CLERICAL SUPERVISOR III	N	SR14	04	P	A	1.00	29,120	1.00	16,837
EDN150/FA	7/26/2013	57094	EDUC ASST III	Y	SR12	03	T	A	1.00	24,450	1.00	26,010
EDN100/AA	7/26/2013	66196	VICE PRINCIPAL III	Certificated	E05	06	T	A	1.00	72,877	1.00	69,097
EDN100/AA	7/27/2013	17531	SCHOOL CUSTODIAN II	N	BC02	01	P	A	0.50	16,247	0.50	16,614
EDN150/FA	7/27/2013	34891	EDUC ASST III	Y	SR12	03	P	A	0.75	18,338	0.75	19,508
EDN150/NB	7/27/2013	800499	EDUC ASST II	Y	SR10	03	T	N			1.00	24,030
EDN100/AA	7/27/2013	14713	OFFICE ASSISTANT III	N	SR08	03	P	A	1.00	29,373	1.00	30,036
EDN150/FA	7/30/2013	55429	EDUC ASST II	Y	SR10	03	P	A	0.50	12,226	0.50	11,565
EDN150/FA	7/30/2013	56717	EDUC ASST III	Y	SR12	03	P	A	0.50	12,226	0.50	13,005
EDN100/AA	7/30/2013	118067	SCHOOL HEALTH AIDE	N	SR09	03	P	A	1.00	18,456	1.00	18,793
EDN100/AA	7/30/2013	802212	EDUC ASST III	Y	SR12	03	T	A	0.75	19,166	0.75	19,508
EDN150/YG	7/30/2013	801708	EDUC ASST II	Y	SR10	03	T	A			1.00	24,030
EDN150/FA	7/30/2013	802562	EDUC ASST II	Y	SR10	03	P	A			1.00	24,030
EDN150/FA	7/30/2013	58123	EDUC ASST III	Y	SR12	03	P	A	1.00	24,450	1.00	26,010
EDN150/FA	7/30/2013	55323	EDUC ASST III	Y	SR12	03	P	A	1.00	24,450	1.00	26,010
EDN150/FA	7/30/2013	17916	EDUC ASST III	Y	SR12	03	P	A	1.00	24,450	1.00	26,010
EDN150/YG	7/30/2013	800815	EDUC ASST III	Y	SR12	03	P	A	1.00	24,109	1.00	26,010
EDN150/YG	7/30/2013	801707	EDUC ASST III	Y	SR12	03	T	A			1.00	26,010
EDN150/FA	7/30/2013	57178	EDUC ASST III	Y	SR12	03	P	A	1.00	24,450	1.00	26,010
EDN100/AA	7/30/2013	23216	EDUC ASST III	Y	SR12	03	P	A	1.00	26,554	1.00	27,020
EDN150/FA	7/30/2013	56029	EDUC ASST III	Y	SR12	03	T	A	1.00	26,395	1.00	28,130
EDN150/FA	7/30/2013	57012	EDUC ASST III	Y	SR12	03	P	A	1.00	28,544	1.00	30,430
EDN100/AA	7/30/2013	53259	EDUC ASST III	Y	SR12	03	P	A	1.00	31,067	1.00	31,640
EDN150/SA	7/30/2013	56278	SPEECH PATHOLOGIST II	Y	SR18	13	P	A	1.00	54,027	1.00	40,548
EDN150/YC	7/30/2013	58399	BEHAVIORAL HLTH SPCLT III	N	SR20	13	T	A	1.00	42,066	1.00	43,812
EDN200/GN	7/30/2013	57970	PROFESSIONAL WORKER III	N	SR20	13	P	A	1.00	41,699	1.00	43,812
EDN150/SA	7/30/2013	31336	SPEECH PATHOLOGIST IV	Y	SR22	13	P	A	1.00	51,891	1.00	45,576
EDN100/AA	7/30/2013	68450	SECONDARY TEACHER	Certificated	T03	05	P	A	1.00	46,948	1.00	47,287
EDN150/SA	7/30/2013	33173	SPEECH PATHOLOGIST IV	Y	SR22	13	P	A	1.00	51,891	1.00	47,400
EDN100/AA	7/30/2013	66413	SECONDARY TEACHER	Certificated	T03	05	P	A	1.00	48,356	1.00	48,706
EDN150/YC	7/30/2013	58485	BEHAVIORAL HLTH SPCLT IV	N	SR22	13	T	A	1.00	43,761	1.00	49,308
EDN150/YC	7/30/2013	54465	PSYCHOLOGICAL EXAMINER IV	Y	SR22	13	P	A	1.00	44,938	1.00	49,308
EDN150/YC	7/30/2013	800465	SCHOOL PSYCHOLOGIST	Y	SR24	13	P	A	1.00	54,194	1.00	53,364
EDN100/AA	7/30/2013	75213	12-MO STUDENT SVCS COORD	Certificated	T06	05	T	A	1.00	75,669	1.00	80,612
EDN150/FA	7/31/2013	51220	EDUC ASST II	Y	SR10	03	P	A	0.50	12,226	0.50	12,015
EDN150/FA	7/31/2013	800578	EDUC ASST III	Y	SR12	03	T	A	0.50	12,704	0.50	13,510
EDN150/FA	7/31/2013	58929	EDUC ASST II	Y	SR10	03	P	A	0.50	12,704	0.50	13,510
EDN150/FA	7/31/2013	54846	EDUC ASST I	Y	SR08	03	P	A	0.62	15,282	0.75	16,687
EDN150/FA	7/31/2013	800279	EDUC ASST III	Y	SR12	03	T	A	0.75	18,338	0.75	19,508
EDN150/FA	7/31/2013	58924	EDUC ASST III	Y	SR12	03	P	A	0.75	18,338	0.75	19,508
EDN100/AA	7/31/2013	30595	SCHOOL SECURITY ATTENDANT	N	SR07	03	P	A	1.00	20,970	1.00	21,390
EDN150/FA	7/31/2013	50864	EDUC ASST III	Y	SR12	03	P	A	0.75	21,407	0.75	22,823
EDN150/SA	7/31/2013	30504	COMMUNICATION AIDE	Y	SR12	03	P	A	0.75	21,107	0.75	22,823
EDN150/FA	7/31/2013	57627	EDUC ASST III	Y	SR12	03	P	A	0.75	21,407	0.75	22,823

Department of Education
Personnel Separations

Table 15

Prog ID/Org	Separation Date	Position Number	Position Title	Exempt (Y/N)	SR Level	BU Code	T/P	MOF	Budgeted FTE	Budgeted Salary	Actual FTE	Actual Salary
EDN150/NB	7/31/2013	802474	EDUC ASST II	Y	SR10	03	T	N			1.00	24,030
EDN150/NB	7/31/2013	801132	EDUC ASST III	Y	SR12	03	T	N			1.00	26,010
EDN150/SA	7/31/2013	30456	COMMUNICATION AIDE	Y	SR12	03	P	A	1.00	25,051	1.00	27,020
EDN150/FA	7/31/2013	69148	SPEC ED TEACHER	Certificated	T02	05	P	A	1.00	46,268	1.00	45,072
EDN150/SA	7/31/2013	56044	SPEECH PATHOLOGIST IV	Y	SR22	13	P	A	1.00	51,005	1.00	47,400
EDN100/AA	7/31/2013	603929	ELEM TEACHER	Certificated	T03	05	T	A			1.00	48,678
EDN100/AA	7/31/2013	62709	ELEM TEACHER	Certificated	T03	05	P	A	1.00	42,204	1.00	48,678
EDN150/SA	7/31/2013	33247	SPEECH PATHOLOGIST IV	Y	SR22	13	P	A	1.00	55,755	1.00	49,308
EDN150/YC	8/1/2013	59133	OFFICE ASSISTANT III	N	SR08	03	T	A	0.50	11,846	0.50	13,350
EDN100/AA	8/1/2013	40299	SCHOOL CUSTODIAN II	N	BC02	01	P	A	0.50	16,247	0.50	16,614
EDN400/MD	8/1/2013	21312	CAFETERIA HELPER	N	BC02	01	P	B	0.50	16,614	0.50	16,614
EDN400/MD	8/1/2013	9481	CAFETERIA HELPER	N	BC02	01	P	A			0.50	16,614
EDN400/MD	8/1/2013	26857	CAFETERIA HELPER	N	BC02	01	P	A			0.50	16,614
EDN100/AA	8/1/2013	21876	SCHOOL CUSTODIAN II	N	BC02	01	P	A	0.50	16,247	0.50	16,614
EDN100/AA	8/1/2013	56213	OFFICE ASSISTANT III	N	SR08	03	T	A			0.50	16,878
EDN150/FA	8/1/2013	33281	EDUC ASST III	Y	SR12	03	P	A	0.87	22,232	0.88	23,642
EDN100/AA	8/1/2013	56414	OFFICE ASSISTANT III	N	SR08	03	P	A	1.00	28,199	1.00	25,668
EDN150/FA	8/1/2013	47063	EDUC ASST III	Y	SR12	03	P	A	1.00	27,479	1.00	29,220
EDN150/FA	8/1/2013	32155	EDUC ASST III	Y	SR12	03	P	A	1.00	29,726	1.00	31,640
EDN400/MD	8/1/2013	24611	CAFETERIA HELPER	N	BC02	01	P	B			1.00	33,228
EDN100/AA	8/1/2013	30877	SCHOOL CUSTODIAN II	N	BC02	01	P	A	1.00	32,494	1.00	33,228
EDN100/AA	8/1/2013	22053	SCHOOL CUSTODIAN II	N	BC02	01	P	A	1.00	32,494	1.00	33,228
EDN150/SA	8/1/2013	801325	EDUCATIONAL INTERPRETER II	N	SR14	03	P	A	1.00	26,733	1.00	33,756
EDN400/MD	8/1/2013	51649	FOOD SERVICES DRIVER	N	BC03	01	P	B	1.00	34,164	1.00	34,164
EDN400/MD	8/1/2013	45921	FOOD SERVICES DRIVER	N	BC03	01	P	A			1.00	34,164
EDN150/FA	8/1/2013	29763	EDUC ASST III	Y	SR12	03	P	A	1.00	32,138	1.00	34,200
EDN100/AA	8/1/2013	16448	SCHOOL CUSTODIAN III	N	WS02	01	P	A	1.00	34,759	1.00	35,544
EDN100/AA	8/1/2013	16526	SCHOOL CUSTODIAN III	N	WS02	01	P	A	1.00	34,759	1.00	35,544
EDN100/AA	8/1/2013	34327	SCHOOL CUSTODIAN III	N	WS02	01	P	A	1.00	34,759	1.00	35,544
EDN100/AA	8/1/2013	602086	12-MO STUDENT SVCS COORD	Certificated	T07	05	T	A	0.50	46,453	0.50	36,855
EDN100/AA	8/1/2013	16581	SCHOOL CUSTODIAN IV	N	F102	02	P	A	1.00	37,317	1.00	39,684
EDN300/UA	8/1/2013	44944	DP USER SUPPORT TECH II	N	SR15	03	P	A	1.00	35,408	1.00	41,040
EDN300/UA	8/1/2013	23740	DATA PROCSSG SYSTS ANAL III	N	SR20	13	P	A	1.00	40,956	1.00	43,812
EDN400/MC	8/1/2013	50316	PRGM SPCLT III	N	SR20	13	T	N	1.00	51,312	1.00	43,812
EDN100/AA	8/1/2013	65309	SECONDARY TEACHER	Certificated	T02	05	P	A	1.00	44,774	1.00	47,817
EDN150/FA	8/1/2013	69397	SPEC ED TEACHER	Certificated	T02	05	P	A	1.00	42,840	1.00	47,817
EDN100/AA	8/1/2013	1887	SCHOOL ADM SERVICES ASST III	Certificated	SR16	04	P	A	1.00	45,156	1.00	48,048
EDN100/BJ	8/1/2013	73419	SPECIAL SCH TEACHER	Certificated	T03	05	T	A	1.00	46,253	1.00	48,706
EDN150/FA	8/1/2013	603208	SPEC ED TEACHER	Certificated	T04	05	T	A			1.00	50,625
EDN100/AA	8/1/2013	64962	SECONDARY TEACHER	Certificated	T03	05	P	A	1.00	46,117	1.00	51,642
EDN150/FA	8/1/2013	62367	SPEC ED TEACHER	Certificated	T03	05	P	A	1.00	47,479	1.00	51,642
EDN100/AA	8/1/2013	1886	SCHOOL ADM SERVICES ASST III	Certificated	SR16	04	P	A	1.00	45,156	1.00	51,936
EDN400/MD	8/1/2013	10317	SCHOOL FOOD SERVICES MGR III	N	F206	02	P	A	1.00	40,925	1.00	52,044
EDN150/YC	8/1/2013	27394	SCHOOL PSYCHOLOGIST	Y	SR24	13	P	A	1.00	54,194	1.00	53,364
EDN100/BB	8/1/2013	79800	STATE OFFICE TEACHER	Certificated	T05	05	T	N			1.00	55,856

<u>Prog ID/Org</u>	<u>Separation Date</u>	<u>Position Number</u>	<u>Position Title</u>	<u>Exempt (Y/N)</u>	<u>SR Level</u>	<u>BU Code</u>	<u>T/P</u>	<u>MOF</u>	<u>Budgeted FTE</u>	<u>Budgeted Salary</u>	<u>Actual FTE</u>	<u>Actual Salary</u>
EDN100/AA	8/1/2013	71605	ELEM TEACHER	Certificated	T04	05	P	A	1.00	53,353	1.00	56,979
EDN150/YC	8/1/2013	58510	BEHAVIORAL HLTH SPCLT IV	N	SR22	13	T	A	1.00	51,226	1.00	57,720
EDN150/YC	8/1/2013	29132	SCH PSYCH (DISTRICT-BASED)	Y	SR26	13	P	A	1.00	52,605	1.00	57,720
EDN150/SA	8/1/2013	30555	PHYSICAL THERAPIST IV	N	SR22	13	P	A	1.00	63,101	1.00	60,012
EDN100/AA	8/1/2013	66491	SECONDARY TEACHER	Certificated	T07	05	P	A	1.00	57,657	1.00	61,576
EDN100/AA	8/1/2013	65018	SECONDARY TEACHER	Certificated	T07	05	P	A	1.00	50,290	1.00	63,423
EDN150/FA	8/1/2013	60802	GEN EDUC/ARTICLE VI TCHR	Certificated	T03	05	P	A	1.00	56,768	1.00	63,513
EDN100/AA	8/1/2013	61396	ELEM TEACHER	Certificated	T06	05	P	A	1.00	63,058	1.00	67,343
EDN100/AA	8/1/2013	65044	ELEM TEACHER	Certificated	T06	05	P	A	1.00	64,949	1.00	69,363
EDN150/SA	8/1/2013	30421	SPEECH PATHOLOGIST IV	Y	SR22	13	P	A	1.00	65,000	1.00	70,188
EDN150/SA	8/1/2013	30427	SPEECH PATHOLOGIST IV	Y	SR22	13	P	A	1.00	65,000	1.00	70,188
EDN150/SA	8/1/2013	30428	SPEECH PATHOLOGIST IV	Y	SR22	13	P	A	1.00	65,000	1.00	70,188
EDN100/AA	8/1/2013	67753	LIBRARIAN	Certificated	T07	05	P	A	1.00	72,178	1.00	75,730
EDN150/FA	8/1/2013	75944	GEN EDUC/ARTICLE VI TCHR	Certificated	T07	05	P	A	1.00	42,738	1.00	75,730
EDN100/AA	8/1/2013	64138	ELEM TEACHER	Certificated	T07	05	P	A	1.00	70,911	1.00	75,730
EDN100/AA	8/1/2013	62488	SECONDARY TEACHER	Certificated	T07	05	P	A	1.00	77,421	1.00	77,982
EDN100/AA	8/1/2013	64696	COUNSELOR	Certificated	T07	05	T	A			1.00	80,275
EDN100/AA	8/1/2013	69683	ELEM TEACHER	Certificated	T07	05	P	A	1.00	78,688	1.00	80,275
EDN150/YC	8/1/2013	58206	CLINICAL PSYCHOLOGIST VIII	N	SR30	13	P	A	1.00	90,213	1.00	99,948
EDN100/AA	8/1/2013	65136	12-MO INTER PRIN IV	Certificated	E07	06	P	A	1.00	116,975	1.00	119,617
EDN100/AA	8/1/2013	63831	12-MO ELEM PRIN III	Certificated	E07	06	P	A	1.00	118,615	1.00	121,294
EDN100/AA	8/1/2013	64449	12-MO HS PRIN VI	Certificated	E09	06	P	A	1.00	128,931	1.00	131,843
EDN150/YG	8/2/2013	801071	EDUC ASST I	Y	SR08	03	P	A			1.00	13,327
EDN400/MD	8/2/2013	801488	CAFETERIA HELPER	N	BC02	01	T	B	0.50	16,614	0.50	16,614
EDN400/MD	8/2/2013	58897	CAFETERIA HELPER	N	BC02	01	T	B			0.50	16,614
EDN100/AA	8/2/2013	118365	SCHOOL HEALTH AIDE	N	SR09	03	P	A	1.00	20,762	1.00	21,133
EDN150/YG	8/2/2013	800886	EDUC ASST III	Y	SR12	03	P	A	1.00	24,109	1.00	26,010
EDN100/AA	8/2/2013	66858	SECONDARY TEACHER	Certificated	T02	05	P	A	1.00	48,356	1.00	43,759
EDN100/AA	8/2/2013	65812	COUNSELOR	Certificated	T04	05	P	A	1.00	44,774	1.00	50,654
EDN150/SA	8/2/2013	56286	SPEECH PATHOLOGIST IV	Y	SR22	13	P	A	1.00	58,715	1.00	51,300
EDN300/KO	8/3/2013	58570	PERSONNEL CLERK V	N	SR13	03	P	A	1.00	32,662	1.00	16,211
EDN400/MD	8/3/2013	54514	CAFETERIA HELPER	N	BC02	01	T	B	0.50	16,614	0.50	16,614
EDN400/MD	8/3/2013	58589	CAFETERIA HELPER	N	BC02	01	T	N			0.50	16,614
EDN400/MD	8/3/2013	41864	CAFETERIA HELPER	N	BC02	01	T	B			0.50	16,614
EDN150/FA	8/3/2013	57604	EDUC ASST II	Y	SR10	03	P	A	0.75	18,338	0.75	18,023
EDN150/FA	8/3/2013	57335	EDUC ASST III	Y	SR12	03	P	A	0.75	20,609	0.75	19,508
EDN150/FA	8/3/2013	55295	EDUC ASST III	Y	SR12	03	P	A	0.75	20,609	0.75	21,915
EDN150/NB	8/3/2013	800561	EDUC ASST III	Y	SR12	03	T	N			1.00	26,010
EDN100/AA	8/3/2013	60858	SECONDARY TEACHER	Certificated	T02	05	P	A	1.00	44,492	1.00	46,424
EDN150/YC	8/3/2013	800428	SCHOOL PSYCHOLOGIST	Y	SR24	13	P	A	1.00	54,194	1.00	53,364
EDN150/FA	8/5/2013	800166	EDUC ASST III	Y	SR12	03	T	A	0.88	21,394	0.88	22,759
EDN150/FA	8/6/2013	802070	EDUC ASST II	Y	SR10	03	T	A	0.75	18,338	0.75	18,023
EDN300/KF	8/6/2013	349	PRE AUDIT CLERK III	N	SR15	03	P	A	1.00	30,335	1.00	35,064
EDN150/FA	8/6/2013	76006	SPEC ED TEACHER	Certificated	T02	05	P	A	1.00	69,884	1.00	43,759
EDN100/AA	8/6/2013	604412	SPEC ED TEACHER	Certificated	T03	05	T	A			1.00	47,259

Department of Education
Personnel Separations

Table 15

<u>Prog ID/Org</u>	<u>Separation Date</u>	<u>Position Number</u>	<u>Position Title</u>	<u>Exempt (Y/N)</u>	<u>SR Level</u>	<u>BU Code</u>	<u>T/P</u>	<u>MOF</u>	<u>Budgeted FTE</u>	<u>Budgeted Salary</u>	<u>Actual FTE</u>	<u>Actual Salary</u>
EDN100/AA	8/7/2013	32659	SCHOOL CUSTODIAN II	N	BC02	01	P	A	0.50	16,247	0.50	16,614
EDN300/KO	8/7/2013	58285	SECRETARY IV	N	SR18	03	P	A	1.00	36,613	1.00	42,684
EDN150/FA	8/7/2013	63181	SPEC ED TEACHER	Certificated	T02	05	P	A	1.00	40,381	1.00	45,072
EDN150/NB	8/8/2013	801751	EDUC ASST II	Y	SR10	03	T	N			0.75	18,023
EDN150/YC	8/8/2013	58474	BEHAVIORAL HLTH SPCLT IV	N	SR22	13	T	A	1.00	47,360	1.00	51,300
EDN100/AA	8/9/2013	73412	SECONDARY TEACHER	Certificated	T02	05	P	A	0.50	22,387	1.00	45,072
EDN500/PC	8/10/2013	802662	OFFICE ASSISTANT III	N	SR08	03	P	A	0.50	12,834	0.50	13,350
EDN150/YG	8/10/2013	802444	EDUC ASST II	Y	SR10	03	T	A			1.00	24,030
EDN100/AA	8/10/2013	66550	ELEM TEACHER	Certificated	T02	05	P	A	1.00	53,870	1.00	43,759
EDN100/AA	8/10/2013	59969	GEN PROF IV	N	SR22	13	T	A			1.00	47,400
EDN150/YC	8/10/2013	58670	SCHOOL PSYCHOLOGIST	Y	SR24	13	P	A	1.00	54,194	1.00	53,364
EDN100/AA	8/10/2013	602282	12-MO SECONDARY TEACHER	Certificated	T07	05	T	A			1.00	73,709
EDN100/AA	8/13/2013	30592	SCHOOL SECURITY ATTENDANT	N	SR07	03	P	A	1.00	29,832	1.00	30,430
EDN100/AA	8/14/2013	23362	OFFICE ASSISTANT III	N	SR08	03	P	A	1.00	25,101	1.00	26,700
EDN150/FA	8/15/2013	801359	EDUC ASST III	Y	SR12	03	P	A			1.00	26,010
EDN400/OC	8/16/2013	16792	POWER MOWER OPERATOR I	N	BC03	01	P	A	1.00	30,682	1.00	17,744
EDN150/SA	8/16/2013	30910	COMMUNICATION AIDE	Y	SR12	03	P	A	0.75	18,081	0.75	19,508
EDN100/AA	8/16/2013	801625	SCHOOL SECURITY ATTENDANT	N	SR07	03	T	A			1.00	20,540
EDN150/FA	8/16/2013	800491	EDUC ASST III	Y	SR12	03	T	A	1.00	24,450	1.00	26,010
EDN150/FA	8/16/2013	52713	EDUC ASST III	Y	SR12	03	P	A	1.00	28,544	1.00	29,220
EDN100/AA	8/16/2013	56580	OFFICE ASSISTANT III	N	SR08	03	P	A	1.00	29,373	1.00	31,212
EDN300/KF	8/16/2013	59797	ACCOUNTANT IV	N	SR22	13	P	A			1.00	47,400
EDN150/SA	8/16/2013	56151	SPEECH PATHOLOGIST IV	Y	SR22	13	P	A	1.00	55,755	1.00	49,308
EDN100/AA	8/17/2013	16392	SCHOOL CUSTODIAN II	N	BC02	01	P	A	0.50	16,247	0.50	16,614
EDN200/GN	8/17/2013	69964	12-MO COMPLEX AREA TEACHER	Certificated	T07	05	P	A	1.00	39,202	1.00	85,447
EDN100/AA	8/20/2013	61557	SECONDARY TEACHER	Certificated	T05	05	P	A	1.00	48,825	1.00	54,229
EDN100/AA	8/21/2013	16075	SCHOOL CUSTODIAN II	N	BC02	01	P	A	1.00	32,494	1.00	33,228
EDN100/AA	8/21/2013	16511	SCHOOL CUSTODIAN II	N	BC02	01	P	A	0.50	16,247	1.00	33,228
EDN300/KO	8/22/2013	19240	PERSONNEL CLERK V	N	SR13	03	P	A	1.00	38,080	1.00	16,211
EDN100/AA	8/22/2013	18072	SCHOOL CUSTODIAN III	N	WS02	01	P	A	1.00	34,970	1.00	35,544
EDN400/OC	8/23/2013	16797	UTILITY WORKER	N	BC03	01	P	A	1.00	30,682	1.00	17,744
EDN300/KD	8/23/2013	60001	ADM ASST TO THE SUPT	N	E10	06	P	A	1.00	89,968	1.00	104,642
EDN100/AA	8/24/2013	19456	EDUC ASST III	Y	SR12	03	P	A	0.50	15,534	0.50	15,820
EDN400/MD	8/24/2013	39933	CAFETERIA HELPER	N	BC02	01	P	A			0.50	16,614
EDN100/AA	8/24/2013	13947	LIBRARY ASSISTANT III	N	SR07	03	P	A	1.00	24,104	1.00	25,668
EDN100/AA	8/24/2013	801804	DP USER SUPPORT TECH I	N	SR13	03	T	A	1.00	33,010	1.00	32,424
EDN150/SA	8/24/2013	30411	SPEECH PATHOLOGIST II	Y	SR18	13	P	A	1.00	61,990	1.00	40,548
EDN150/YC	8/24/2013	58091	HUMAN SVCS PROF IV	N	SR22	13	P	A	1.00	42,066	1.00	47,400
EDN100/BM	8/24/2013	48257	ATHLETIC HLTH CARE TRAINER	Y	SR22	13	P	A	1.00	42,073	1.00	47,400
EDN100/AA	8/24/2013	602387	ELEM TEACHER	Certificated	T03	05	T	A			1.00	48,678
EDN100/AA	8/24/2013	602243	SECONDARY TEACHER	Certificated	T04	05	T	A			1.00	50,625
EDN150/YC	8/24/2013	30689	SCHOOL PSYCHOLOGIST	Y	SR24	13	P	A	1.00	54,194	1.00	53,364
EDN100/AA	8/27/2013	33098	SCHOOL SECURITY ATTENDANT	N	SR07	03	P	A	1.00	26,554	1.00	26,010
EDN100/AA	8/27/2013	51982	EDUC ASST III	Y	SR12	03	P	A	1.00	29,832	1.00	29,220
EDN150/FA	8/28/2013	56765	EDUC ASST III	Y	SR12	03	T	A	0.50	12,226	0.50	13,005

Department of Education
Personnel Separations

Table 15

<u>Prog ID/Org</u>	<u>Separation Date</u>	<u>Position Number</u>	<u>Position Title</u>	<u>Exempt (Y/N)</u>	<u>SR Level</u>	<u>BU Code</u>	<u>T/P</u>	<u>MOF</u>	<u>Budgeted FTE</u>	<u>Budgeted Salary</u>	<u>Actual FTE</u>	<u>Actual Salary</u>
EDN150/FA	8/29/2013	56687	EDUC ASST II	Y	SR10	03	P	A	0.75	18,338	0.75	18,023
EDN150/YC	8/30/2013	58078	HUMAN SVCS PROF IV	N	SR22	13	P	A	1.00	42,066	1.00	24,613
EDN150/YC	8/30/2013	58089	SOCIAL WORKER IV	N	SR22	13	P	A	1.00	45,533	1.00	24,613
EDN150/FA	8/30/2013	73214	SPEC ED TCHR/PRE-SCHOOL	Certificated	T03	05	P	A	1.00	51,021	1.00	48,678
EDN100/AA	8/31/2013	29467	SCHOOL HEALTH AIDE	N	SR09	03	P	A	1.00	18,456	1.00	18,793
EDN150/FA	8/31/2013	52682	EDUC ASST III	Y	SR12	03	P	A	0.75	22,294	0.75	23,730
EDN100/AA	8/31/2013	29391	SCHOOL HEALTH AIDE	N	SR09	03	P	A	1.00	25,242	1.00	25,707
EDN150/YG	8/31/2013	801702	EDUC ASST III	Y	SR12	03	T	A			1.00	26,010
EDN150/YG	8/31/2013	800832	EDUC ASST III	Y	SR12	03	T	A	1.00	24,109	1.00	26,010
EDN100/AA	8/31/2013	55398	OFFICE ASSISTANT III	N	SR08	03	T	A	1.00	26,110	1.00	27,756
EDN150/FA	8/31/2013	73796	SPEC ED TCHR/PRE-SCHOOL	Certificated	T02	05	P	A	1.00	48,585	1.00	33,169
EDN100/AA	8/31/2013	41909	SCHOOL CUSTODIAN II	N	BC02	01	P	A	1.00	32,494	1.00	33,228
EDN100/AA	8/31/2013	18682	SCHOOL CUSTODIAN II	N	BC02	01	P	A	1.00	32,494	1.00	33,228
EDN200/GN	8/31/2013	58050	OFFICE ASSISTANT III	N	SR08	03	P	A	1.00	29,453	1.00	33,756
EDN400/MD	8/31/2013	12210	SCHOOL COOK II	N	BC06	01	P	B	1.00	38,436	1.00	38,436
EDN100/AA	8/31/2013	18032	OFFICE ASSISTANT III	N	SR08	03	P	A	1.00	38,608	1.00	41,040
EDN400/OC	8/31/2013	17119	BUILDING MAINTENANCE WORKER II	N	WS09	01	P	A	1.00	42,451	1.00	47,268
EDN150/SA	8/31/2013	28718	OCC THERAPIST IV	N	SR22	13	P	A	1.00	56,680	1.00	47,400
EDN150/YC	8/31/2013	800424	SCHOOL PSYCHOLOGIST	Y	SR24	13	P	A	1.00	54,194	1.00	53,364
EDN150/YC	8/31/2013	800467	SCHOOL PSYCHOLOGIST	Y	SR24	13	P	A	1.00	54,194	1.00	53,364
EDN100/AA	8/31/2013	68908	SECONDARY TEACHER	Certificated	T05	05	P	A	1.00	52,302	1.00	55,856
EDN100/AA	8/31/2013	72027	SECONDARY TEACHER	Certificated	T03	05	P	A	1.00	48,356	1.00	57,279
EDN400/MB	8/31/2013	9894	SCHOOL LUNCH SERVICES SUPVR	N	SR24	13	P	A	1.00	49,593	1.00	57,720
EDN100/BM	8/31/2013	52469	ATHLETIC HLTH CARE TRAINER	Y	SR22	13	P	A	1.00	53,272	1.00	60,012
EDN400/MB	8/31/2013	58606	SCHOOL LUNCH SERVICES SUPVR	N	SR24	13	P	B	1.00	60,024	1.00	62,424
EDN100/AA	9/1/2013	68970	ELEM TEACHER	Certificated	T03	05	P	A	1.00	49,806	1.00	53,192
EDN100/AA	9/1/2013	61655	SECONDARY TEACHER	Certificated	T06	05	P	A	1.00	57,047	1.00	59,833
EDN100/AA	9/1/2013	62946	ELEM TEACHER	Certificated	T07	05	P	A	1.00	59,388	1.00	63,423
EDN100/AA	9/1/2013	61942	SECONDARY TEACHER	Certificated	T07	05	P	A	1.00	66,841	1.00	67,325
EDN100/AA	9/1/2013	603073	ELEM TEACHER	Certificated	T07	05	T	A			1.00	73,525
EDN150/FA	9/1/2013	65760	SPEC ED TEACHER	Certificated	T07	05	P	A	1.00	30,609	1.00	80,275
EDN150/FA	9/3/2013	601255	SPEC ED TEACHER	Certificated	T04	05	T	A	1.00	46,717	1.00	49,179
EDN150/FA	9/4/2013	53123	EDUC ASST II	Y	SR10	03	T	A	0.75	18,338	0.75	18,023
EDN500/WA	9/4/2013	800752	ACCOUNT CLERK III	N	SR11	03	T	W			1.00	28,836
EDN100/AA	9/4/2013	69195	SECONDARY TEACHER	Certificated	T02	05	P	A	1.00	45,579	1.00	43,759
EDN100/DB	9/4/2013	600577	DIST OFF TCHR	Certificated	T03	05	T	N			1.00	53,192
EDN150/YC	9/6/2013	58497	BEHAVIORAL HLTH SPCLT IV	N	SR22	13	P	A	1.00	53,264	1.00	53,364
EDN100/AA	9/7/2013	802985	DP USER SUPPORT TECH I	N	SR13	03	T	A			1.00	31,212
EDN100/AA	9/7/2013	11130	OFFICE ASSISTANT III	N	SR08	03	P	A	1.00	30,523	1.00	32,424
EDN100/BM	9/7/2013	49234	ATHLETIC HLTH CARE TRAINER	Y	SR22	13	P	A	1.00	42,073	1.00	47,400
EDN100/AA	9/7/2013	62064	SECONDARY TEACHER	Certificated	T03	05	T	A			1.00	53,192
EDN300/KO	9/7/2013	59118	PERSONNEL MGMT SPECIALIST V	N	SR24	13	P	A	1.00	45,896	1.00	55,488
EDN100/AA	9/10/2013	22218	SCHOOL CUSTODIAN II	N	BC02	01	P	A	0.50	16,247	0.50	16,614
EDN150/YC	9/12/2013	58345	BEHAVIORAL HLTH SPCLT IV	N	SR22	13	P	A	1.00	42,066	1.00	47,400
EDN150/YC	9/13/2013	58642	BEHAVIORAL SPECIALIST IV	N	SR22	13	P	A	1.00	45,533	1.00	51,300

Department of Education
Personnel Separations

Table 15

Prog ID/Org	Separation Date	Position Number	Position Title	Exempt (Y/N)	SR Level	BU Code	T/P	MOF	Budgeted FTE	Budgeted Salary	Actual FTE	Actual Salary
EDN400/MD	9/14/2013	30062	CAFETERIA HELPER	N	BC02	01	T	N	0.50	16,614	0.50	16,614
EDN400/MD	9/14/2013	35309	CAFETERIA HELPER	N	BC02	01	T	B			0.50	16,614
EDN100/AA	9/14/2013	66811	SECONDARY TEACHER	Certificated	T06	05	P	A	1.00	55,415	1.00	58,090
EDN100/AA	9/17/2013	66675	ELEM TEACHER	Certificated	T03	05	P	A	1.00	47,969	1.00	48,678
EDN100/AA	9/17/2013	74960	SECONDARY TEACHER	Certificated	T05	05	P	A	1.00	52,302	1.00	55,856
EDN150/YG	9/18/2013	800829	EDUC ASST III	Y	SR12	03	P	A	1.00	25,053	1.00	26,010
EDN150/YG	9/18/2013	801941	SCHOOL PSYCHOLOGIST	Y	SR24	13	T	A			1.00	27,713
EDN100/AA	9/18/2013	68823	SECONDARY TEACHER	Certificated	T05	05	P	A	1.00	47,403	1.00	52,650
EDN100/BM	9/19/2013	52456	ATHLETIC HLTH CARE TRAINER	Y	SR22	13	P	A	1.00	42,073	1.00	47,400
EDN100/AA	9/20/2013	71147	ELEM TEACHER	Certificated	T07	05	P	A	1.00	57,657	1.00	61,576
EDN150/FA	9/21/2013	55301	EDUC ASST III	Y	SR12	03	P	A	0.50	12,226	0.50	13,005
EDN300/KO	9/21/2013	19133	PERSONNEL CLERK III	N	SR09	03	P	A	1.00	25,726	1.00	28,836
EDN100/AA	9/21/2013	601313	ELEM TEACHER	Certificated	T03	05	T	A			1.00	48,678
EDN100/AA	9/23/2013	75165	12-MO STUDENT SVCS COORD	Certificated	T05	05	T	A	1.00	70,638	1.00	75,254
EDN100/AA	9/24/2013	43092	OFFICE ASSISTANT III	N	SR08	03	P	A	1.00	29,373	1.00	31,212
EDN100/AA	9/24/2013	73412	SECONDARY TEACHER	Certificated	T02	05	P	A	0.50	22,387	1.00	43,759
EDN150/FA	9/26/2013	57369	EDUC ASST III	Y	SR12	03	T	A	0.75	18,338	0.75	19,508
EDN150/YC	9/26/2013	58625	BEHAVIORAL HLTH SPCLT IV	N	SR22	13	P	A	1.00	43,761	1.00	49,308
EDN100/AA	9/27/2013	14694	OFFICE ASSISTANT III	N	SR08	03	P	A	1.00	28,199	1.00	30,036
EDN150/YC	9/27/2013	58493	BEHAVIORAL HLTH SPCLT IV	N	SR22	13	P	A	1.00	45,533	1.00	51,300
EDN150/FA	9/28/2013	602311	SPEC ED TEACHER	Certificated	T02	05	T	A	1.00	40,381	1.00	45,072
EDN100/AA	10/1/2013	56566	OFFICE ASSISTANT III	N	SR08	03	P	A	0.50	12,550	0.50	13,350
EDN100/AA	10/1/2013	52441	EDUC ASST III	Y	SR12	03	P	A	0.50	15,534	0.50	15,820
EDN400/MD	10/1/2013	26848	CAFETERIA HELPER	N	BC02	01	P	B	0.50	16,614	0.50	16,614
EDN100/AA	10/1/2013	21886	SCHOOL CUSTODIAN II	N	BC02	01	P	A	0.50	16,247	0.50	16,614
EDN400/MD	10/1/2013	42859	CAFETERIA HELPER	N	BC02	01	T	B			0.50	16,614
EDN100/AA	10/1/2013	33122	SCHOOL SECURITY ATTENDANT	N	SR07	03	P	A	1.00	23,615	1.00	21,390
EDN150/YG	10/1/2013	801832	EDUC ASST III	Y	SR12	03	T	A	1.00	27,712	1.00	31,212
EDN100/AA	10/1/2013	44171	LIBRARY ASSISTANT III	N	SR07	03	P	A	1.00	30,523	1.00	32,424
EDN150/FA	10/1/2013	75918	GEN EDUC/ARTICLE VI TCHR	Certificated	T02	05	P	A	1.00	55,035	1.00	33,169
EDN100/AA	10/1/2013	603759	ELEM TEACHER	Certificated	T02	05	T	A			1.00	33,169
EDN100/AA	10/1/2013	32522	SCHOOL CUSTODIAN II	N	BC02	01	P	A	1.00	32,494	1.00	33,228
EDN100/AA	10/1/2013	16421	SCHOOL CUSTODIAN II	N	BC02	01	P	A	1.00	32,494	1.00	33,228
EDN400/MD	10/1/2013	18077	FOOD SERVICES DRIVER	N	BC03	01	P	B	1.00	34,164	1.00	34,164
EDN100/AA	10/1/2013	45312	OFFICE ASSISTANT III	N	SR08	03	P	A	1.00	33,010	1.00	35,064
EDN100/AA	10/1/2013	801395	DP USER SUPPORT TECH II	N	SR15	03	T	A	1.00	33,010	1.00	35,064
EDN400/OC	10/1/2013	17059	PURCHASING TECHNICIAN I	N	SR11	03	P	A	1.00	34,099	1.00	39,480
EDN500/PC	10/1/2013	802660	OFFICE ASSISTANT III	N	SR08	03	T	A	1.00	25,668	1.00	41,040
EDN400/MD	10/1/2013	1954	SCHOOL FOOD SERVICES MGR II	N	F106	02	P	A	1.00	38,453	1.00	48,900
EDN150/FA	10/1/2013	66793	GEN EDUC/ARTICLE VI TCHR	Certificated	T05	05	P	A	1.00	47,057	1.00	52,650
EDN300/UA	10/1/2013	800753	DATA PROCSSG SYSTS ANAL V	N	SR24	13	P	A	1.00	47,544	1.00	55,488
EDN150/FA	10/1/2013	72706	SPEC ED TEACHER	Certificated	T04	05	P	A	1.00	51,049	1.00	56,979
EDN100/AA	10/1/2013	68557	ELEM TEACHER	Certificated	T04	05	P	A	1.00	53,353	1.00	56,979
EDN150/YG	10/1/2013	600790	12-MO DIST OFF TCHR	Certificated	T03	05	T	A	1.00	66,644	1.00	58,269
EDN100/AA	10/1/2013	68812	SECONDARY TEACHER	Certificated	T02	05	P	A	1.00	55,066	1.00	58,808

Prog ID/Org	Separation Date	Position Number	Position Title	Exempt (Y/N)	SR Level	BU Code	T/P	MOF	Budgeted FTE	Budgeted Salary	Actual FTE	Actual Salary
EDN100/AA	10/1/2013	62050	SECONDARY TEACHER	Certificated	T04	05	P	A	1.00	57,657	1.00	62,262
EDN150/NB	10/1/2013	79350	DIST OFF TCHR	Certificated	T07	05	T	N			1.00	65,326
EDN150/FA	10/1/2013	62591	GEN EDUC/ARTICLE VI TCHR	Certificated	T07	05	P	A	1.00	58,387	1.00	65,326
EDN150/FA	10/1/2013	601840	SPEC ED TEACHER	Certificated	T07	05	T	A	1.00	60,283	1.00	67,285
EDN150/FA	10/1/2013	65159	SPEC ED TEACHER	Certificated	T07	05	P	A	1.00	63,955	1.00	67,325
EDN150/FA	10/1/2013	63556	SPEC ED TEACHER	Certificated	T06	05	P	A	1.00	62,144	1.00	69,363
EDN150/SA	10/1/2013	30576	OCC THERAPIST IV	N	SR22	13	P	A	1.00	63,333	1.00	70,188
EDN100/AA	10/1/2013	600036	SECONDARY TEACHER	Certificated	T07	05	T	A	1.00	70,911	1.00	75,730
EDN300/KO	10/1/2013	69981	PERSONNEL SPECIALIST III	Certificated	E08	06	P	A	1.00	71,683	1.00	80,350
EDN200/GN	10/1/2013	75412	DISTRICT EDUC SPEC II	Certificated	E07	06	P	A	1.00	99,101	1.00	109,099
EDN100/AA	10/1/2013	75685	12-MO ELEM PRIN III	Certificated	E07	06	P	A	1.00	118,615	1.00	121,294
EDN150/YC	10/2/2013	58308	BEHAVIORAL SPECIALIST IV	N	SR22	13	P	A	1.00	53,264	1.00	60,024
EDN150/FA	10/4/2013	72433	SPEC ED TEACHER	Certificated	T03	05	P	A	1.00	37,958	1.00	48,678
EDN400/MD	10/5/2013	51647	CAFETERIA HELPER	N	BC02	01	T	N			0.50	16,614
EDN150/FA	10/5/2013	10883	EDUC ASST III	Y	SR12	03	P	A	1.00	25,407	1.00	26,010
EDN150/FA	10/5/2013	57072	EDUC ASST III	Y	SR12	03	P	A	1.00	24,450	1.00	26,010
EDN100/AA	10/5/2013	63953	SECONDARY TEACHER	Certificated	T02	05	P	A	1.00	70,911	1.00	33,169
EDN100/BX	10/5/2013	802974	SCHOOL DORMITORY ATTENDANT	N	HE03	10	P	A			1.00	33,780
EDN100/AA	10/5/2013	600564	SPEC ED TEACHER	Certificated	T02	05	T	A			1.00	43,759
EDN100/AA	10/5/2013	75155	SECONDARY TEACHER	Certificated	T02	05	P	A	1.00	45,579	1.00	43,759
EDN150/FA	10/5/2013	600165	GEN EDUC/ARTICLE VI TCHR	Certificated	T02	05	T	A	1.00	43,507	1.00	45,072
EDN150/FA	10/5/2013	602956	GEN EDUC/ARTICLE VI TCHR	Certificated	T03	05	T	A			1.00	48,678
EDN100/AA	10/5/2013	74854	ELEM TEACHER	Certificated	T03	05	P	A	1.00	46,948	1.00	50,138
EDN150/YC	10/9/2013	58540	BEHAVIORAL HLTH SPCLT IV	N	SR22	13	T	A	1.00	45,533	1.00	51,300
EDN300/KO	10/9/2013	73073	PERSONNEL SPECIALIST II	Certificated	E07	06	P	A	1.00	69,717	1.00	78,146
EDN150/YC	10/10/2013	58634	BEHAVIORAL HLTH SPCLT IV	N	SR22	13	P	A	1.00	51,226	1.00	57,720
EDN100/AA	10/11/2013	801146	OFFICE ASSISTANT III	N	SR08	03	T	A	0.50	12,550	0.50	13,350
EDN150/FA	10/12/2013	57239	EDUC ASST III	Y	SR12	03	T	A	1.00	25,407	1.00	27,020
EDN100/AA	10/15/2013	29319	SCHOOL HEALTH AIDE	N	SR09	03	P	A	1.00	19,933	1.00	21,133
EDN150/FA	10/15/2013	56041	EDUC ASST III	Y	SR12	03	T	A	1.00	26,395	1.00	26,010
EDN150/SA	10/15/2013	801319	EDUCATIONAL INTERPRETER I	N	SR12	03	P	A	1.00	24,765	1.00	31,212
EDN100/BM	10/15/2013	52463	ATHLETIC HLTH CARE TRAINER	Y	SR22	13	P	A	1.00	42,073	1.00	47,400
EDN150/SA	10/15/2013	29816	SPEECH PATHOLOGIST IV	Y	SR22	13	P	A	1.00	57,648	1.00	47,412
EDN100/AA	10/16/2013	800976	OFFICE ASSISTANT III	N	SR08	03	T	A	1.00	25,101	1.00	26,700
EDN300/KO	10/16/2013	19242	PERSONNEL CLERK III	N	SR09	03	P	A	1.00	24,762	1.00	28,836
EDN100/AA	10/16/2013	62737	SECONDARY TEACHER	Certificated	T03	05	T	A	1.00	45,579	1.00	48,678
EDN300/UA	10/16/2013	47862	DATA PROCSSG SYSTS ANAL V	N	SR24	13	P	A	1.00	62,986	1.00	67,512
EDN150/YG	10/18/2013	800473	EDUC ASST III	Y	SR12	03	P	A	1.00	24,109	1.00	26,010
EDN100/AA	10/18/2013	68860	ELEM TEACHER	Certificated	T03	05	T	A	1.00	47,969	1.00	50,138
EDN150/FA	10/19/2013	58118	EDUC ASST III	Y	SR12	03	P	A	0.75	19,056	0.75	18,773
EDN150/FA	10/19/2013	57421	EDUC ASST III	Y	SR12	03	T	A	0.75	19,056	0.75	18,773
EDN150/FA	10/19/2013	56829	EDUC ASST III	Y	SR12	03	T	A	1.00	24,450	1.00	26,010
EDN150/FA	10/19/2013	57267	EDUC ASST III	Y	SR12	03	P	A	1.00	26,395	1.00	28,130
EDN100/AA	10/19/2013	16516	SCHOOL CUSTODIAN II	N	BC02	01	P	A	1.00	32,494	1.00	33,888
EDN100/AA	10/19/2013	601556	VICE PRINCIPAL I	Certificated	E03	06	T	A	1.00	67,046	1.00	63,568

<u>Prog ID/Org</u>	<u>Separation Date</u>	<u>Position Number</u>	<u>Position Title</u>	<u>Exempt (Y/N)</u>	<u>SR Level</u>	<u>BU Code</u>	<u>T/P</u>	<u>MOF</u>	<u>Budgeted FTE</u>	<u>Budgeted Salary</u>	<u>Actual FTE</u>	<u>Actual Salary</u>
EDN100/AA	10/22/2013	801956	SCHOOL CUSTODIAN II	N	BC02	01	T	A	0.50	16,247	0.50	16,944
EDN100/AA	10/22/2013	600069	ELEM TEACHER	Certificated	T02	05	T	A	1.00	42,204	1.00	42,509
EDN100/AA	10/22/2013	61883	COUNSELOR	Certificated	T07	05	P	A	1.00	45,579	1.00	65,326
EDN150/FA	10/23/2013	66291	GEN EDUC/ARTICLE VI TCHR	Certificated	T03	05	P	A			1.00	35,822
EDN100/AA	10/26/2013	63489	ELEM TEACHER	Certificated	T02	05	T	A	1.00	48,825	1.00	45,072
EDN150/SA	10/29/2013	46779	SPEECH PATHOLOGIST IV	Y	SR22	13	P	A	1.00	57,907	1.00	49,332
EDN150/FA	10/30/2013	60778	SPEC ED TEACHER	Certificated	T03	05	P	A	1.00	69,884	1.00	48,678
EDN100/AA	11/1/2013	56466	OFFICE ASSISTANT III	N	SR08	03	P	A	0.50	12,550	0.50	13,350
EDN150/YC	11/1/2013	59139	OFFICE ASSISTANT III	N	SR08	03	T	A	0.50	12,809	0.50	14,418
EDN400/MD	11/1/2013	20662	CAFETERIA HELPER	N	BC02	01	T	N	0.50	16,614	0.50	16,944
EDN150/FA	11/1/2013	57195	EDUC ASST III	Y	SR12	03	T	A	0.75	18,338	0.75	19,508
EDN150/FA	11/1/2013	58863	EDUC ASST III	Y	SR12	03	T	A	0.75	19,056	0.75	20,265
EDN150/FA	11/1/2013	57576	EDUC ASST II	Y	SR10	03	P	A	0.87	21,394	0.88	21,026
EDN150/FA	11/1/2013	800122	EDUC ASST III	Y	SR12	03	P	A	0.75	21,407	0.75	22,823
EDN100/AA	11/1/2013	29364	SCHOOL HEALTH AIDE	N	SR09	03	P	A	1.00	25,361	1.00	25,707
EDN100/AA	11/1/2013	18040	OFFICE ASSISTANT III	N	SR08	03	P	A	1.00	25,101	1.00	26,700
EDN300/KO	11/1/2013	10407	PERSONNEL CLERK V	N	SR13	03	P	A	1.00	29,002	1.00	33,756
EDN100/AA	11/1/2013	26635	SCHOOL CUSTODIAN II	N	BC02	01	P	A	1.00	32,494	1.00	33,888
EDN100/AA	11/1/2013	16630	SCHOOL CUSTODIAN II	N	BC02	01	P	A	1.00	32,494	1.00	33,888
EDN100/AA	11/1/2013	28513	EDUC ASST III	Y	SR12	03	P	A	1.00	36,315	1.00	35,570
EDN400/MD	11/1/2013	9828	SCHOOL BAKER	N	BC06	01	P	B	1.00	38,436	1.00	39,204
EDN150/SA	11/1/2013	33179	SPEECH PATHOLOGIST II	Y	SR18	13	P	A	1.00	51,979	1.00	40,548
EDN400/OC	11/1/2013	17087	CARPENTER I	N	BC09	01	P	A	1.00	43,194	1.00	45,432
EDN300/UA	11/1/2013	801399	DATA PROCSSG SYSTS ANAL IV	N	SR22	13	T	A			1.00	47,400
EDN150/FA	11/1/2013	72204	SPEC ED TEACHER	Certificated	T04	05	P	A	1.00	46,268	1.00	50,654
EDN400/OC	11/1/2013	17214	AUTOMOTIVE MECHANIC SUPVR I	N	F110	02	P	A	1.00	48,152	1.00	55,764
EDN100/AA	11/1/2013	603773	ELEM TEACHER	Certificated	T07	05	T	A			1.00	67,285
EDN100/AA	11/1/2013	72543	SECONDARY TEACHER	Certificated	T07	05	P	A	1.00	63,004	1.00	67,285
EDN100/AA	11/1/2013	69903	SECONDARY TEACHER	Certificated	T05	05	T	A			1.00	68,695
EDN300/KO	11/1/2013	14751	PERSONNEL MGMT SPECIALIST V	N	SR24	13	P	A	1.00	45,896	1.00	70,188
EDN100/AA	11/1/2013	62409	ELEM TEACHER	Certificated	T07	05	P	A	1.00	45,579	1.00	73,525
EDN100/DB	11/1/2013	79208	12-MO STATE OFF TCHR	Certificated	T07	05	T	N			1.00	88,012
EDN100/AA	11/2/2013	58866	EDUC ASST III	Y	SR12	03	P	A	0.50	12,777	0.50	13,005
EDN100/AA	11/2/2013	40086	OFFICE ASSISTANT III	N	SR08	03	P	A	1.00	33,010	1.00	25,668
EDN150/FA	11/2/2013	603208	SPEC ED TEACHER	Certificated	T02	05	T	A			1.00	43,759
EDN100/DB	11/2/2013	79420	SECONDARY TEACHER	Certificated	T02	05	T	N			1.00	45,072
EDN100/AA	11/2/2013	66366	ELEM TEACHER	Certificated	T02	05	T	A	1.00	52,302	1.00	45,072
EDN100/AA	11/2/2013	60801	SECONDARY TEACHER	Certificated	T03	05	P	A	1.00	46,601	1.00	48,678
EDN100/AA	11/2/2013	64237	ELEM TEACHER	Certificated	T03	05	T	A	1.00	45,579	1.00	48,678
EDN150/YC	11/5/2013	58464	BEHAVIORAL HLTH SPCLT IV	N	SR22	13	P	A	1.00	42,066	1.00	47,400
EDN150/FA	11/7/2013	601269	SPEC ED TEACHER	Certificated	T03	05	T	A			1.00	48,678
EDN100/AA	11/8/2013	29415	SCHOOL HEALTH AIDE	N	SR09	03	P	A	1.00	24,238	1.00	18,793
EDN100/AA	11/9/2013	59523	SCHOOL CUSTODIAN II	N	BC02	01	P	A	0.50	16,247	0.50	16,944
EDN400/MD	11/9/2013	59061	CAFETERIA HELPER	N	BC02	01	T	B			0.50	16,944
EDN150/YG	11/9/2013	800882	EDUC ASST III	Y	SR12	03	P	A	1.00	24,109	1.00	26,010

Prog ID/Org	Separation Date	Position Number	Position Title	Exempt (Y/N)	SR Level	BU Code	T/P	MOF	Budgeted FTE	Budgeted Salary	Actual FTE	Actual Salary
EDN150/FA	11/12/2013	71275	SPEC ED TEACHER	Certificated	T02	05	T	A	1.00	43,611	1.00	45,072
EDN100/AA	11/12/2013	69356	SECONDARY TEACHER	Certificated	T04	05	P	A	1.00	50,290	1.00	53,707
EDN150/FB	11/14/2013	801444	HSEAPARENT FOR DEAF/BLIND (FP)	N	HE05	10	P	A	1.00	31,126	1.00	35,952
EDN150/FA	11/14/2013	62885	SPEC ED TEACHER	Certificated	T03	05	P	A	1.00	44,920	1.00	48,678
EDN100/AA	11/14/2013	65350	SECONDARY TEACHER	Certificated	T07	05	P	A	1.00	57,706	1.00	65,326
EDN400/MD	11/15/2013	50304	CAFETERIA HELPER	N	BC02	01	T	N	0.50	16,614	0.50	16,944
EDN400/MD	11/15/2013	29061	CAFETERIA HELPER	N	BC02	01	P	A			0.50	16,944
EDN400/MD	11/15/2013	44491	CAFETERIA HELPER	N	BC02	01	T	B	0.50	16,614	0.50	16,944
EDN400/MD	11/15/2013	42811	CAFETERIA HELPER	N	BC02	01	T	N	0.50	16,614	0.50	16,944
EDN400/MD	11/15/2013	59950	CAFETERIA HELPER	N	BC02	01	T	N	0.50	16,614	0.50	16,944
EDN400/MD	11/15/2013	46011	CAFETERIA HELPER	N	BC02	01	T	B			0.50	16,944
EDN400/MD	11/15/2013	23119	CAFETERIA HELPER	N	BC02	01	T	N			0.50	16,944
EDN400/MD	11/15/2013	801269	CAFETERIA HELPER	N	BC02	01	T	B			0.50	16,944
EDN400/MD	11/15/2013	59513	CAFETERIA HELPER	N	BC02	01	T	B			0.50	16,944
EDN400/MD	11/15/2013	802865	CAFETERIA HELPER	N	BC02	01	T	N			0.50	16,944
EDN400/MD	11/15/2013	801487	CAFETERIA HELPER	N	BC02	01	T	N			0.50	16,944
EDN400/MD	11/15/2013	801644	CAFETERIA HELPER	N	BC02	01	T	B			0.50	16,944
EDN400/MD	11/15/2013	52937	CAFETERIA HELPER	N	BC02	01	T	N			0.50	16,944
EDN400/MD	11/15/2013	59648	CAFETERIA HELPER	N	BC02	01	T	N			0.50	16,944
EDN400/MD	11/15/2013	44466	CAFETERIA HELPER	N	BC02	01	T	N			0.50	16,944
EDN400/MD	11/15/2013	47738	CAFETERIA HELPER	N	BC02	01	T	B	0.50	16,614	0.50	16,944
EDN400/MD	11/15/2013	52945	CAFETERIA HELPER	N	BC02	01	T	N			0.50	16,944
EDN400/MD	11/15/2013	32420	CAFETERIA HELPER	N	BC02	01	T	B			0.50	16,944
EDN400/MD	11/15/2013	52991	CAFETERIA HELPER	N	BC02	01	T	N			0.50	16,944
EDN400/MD	11/15/2013	802415	CAFETERIA HELPER	N	BC02	01	T	N	0.50	16,614	0.50	16,944
EDN400/MD	11/15/2013	45850	CAFETERIA HELPER	N	BC02	01	T	N	0.50	16,614	0.50	16,944
EDN400/MD	11/15/2013	801248	CAFETERIA HELPER	N	BC02	01	T	N	0.50	16,614	0.50	16,944
EDN400/MD	11/15/2013	50817	CAFETERIA HELPER	N	BC02	01	T	N	0.50	16,614	0.50	16,944
EDN400/MD	11/15/2013	9227	CAFETERIA HELPER	N	BC02	01	T	N			0.50	16,944
EDN400/MD	11/15/2013	57694	CAFETERIA HELPER	N	BC02	01	T	N			0.50	16,944
EDN400/MD	11/15/2013	49648	CAFETERIA HELPER	N	BC02	01	T	N	0.50	16,614	0.50	16,944
EDN150/FA	11/15/2013	57608	EDUC ASST III	Y	SR12	03	P	A	0.75	19,796	0.75	20,265
EDN400/MD	11/15/2013	55921	FOOD SERVICES DRIVER	N	BC03	01	T	B			1.00	34,848
EDN400/MD	11/15/2013	58837	FOOD SERVICES DRIVER	N	BC03	01	T	B			1.00	34,848
EDN400/MD	11/15/2013	57695	FOOD SERVICES DRIVER	N	BC03	01	T	B			1.00	34,848
EDN100/AA	11/16/2013	802294	OFFICE ASSISTANT III	N	SR08	03	T	A	0.50	12,550	0.50	13,350
EDN100/AA	11/16/2013	17503	SCHOOL CUSTODIAN II	N	BC02	01	P	A	0.50	16,247	0.50	16,944
EDN150/YG	11/16/2013	801527	EDUC ASST III	Y	SR12	03	T	A			1.00	26,010
EDN100/AA	11/16/2013	801535	OFFICE ASSISTANT III	N	SR08	03	P	A	1.00	25,101	1.00	28,836
EDN100/AA	11/16/2013	56451	ACCOUNT CLERK II	N	SR08	03	P	A	1.00	28,199	1.00	30,036
EDN400/MD	11/16/2013	4390	CAFETERIA HELPER	N	BC02	01	P	A	1.00	26,463	1.00	33,888
EDN150/FA	11/16/2013	73363	SPEC ED TEACHER	Certificated	T07	05	P	A	1.00	55,167	1.00	61,576
EDN100/AA	11/19/2013	28463	SCHOOL CUSTODIAN II	N	BC02	01	P	A	0.50	16,247	0.50	16,944
EDN100/AA	11/20/2013	67509	SECONDARY TEACHER	Certificated	T02	05	P	A	1.00	43,470	1.00	33,169
EDN100/AA	11/22/2013	800892	SCHOOL CUSTODIAN II	N	BC02	01	P	A	0.50	16,247	0.50	16,944

<u>Prog ID/Org</u>	<u>Separation Date</u>	<u>Position Number</u>	<u>Position Title</u>	<u>Exempt (Y/N)</u>	<u>SR Level</u>	<u>BU Code</u>	<u>T/P</u>	<u>MOF</u>	<u>Budgeted FTE</u>	<u>Budgeted Salary</u>	<u>Actual FTE</u>	<u>Actual Salary</u>
EDN100/AA	11/23/2013	43492	OFFICE ASSISTANT III	N	SR08	03	P	A	0.50	12,550	0.50	13,350
EDN100/AA	11/23/2013	802008	OFFICE ASSISTANT III	N	SR08	03	T	A	0.50	12,550	0.50	13,350
EDN150/FA	11/23/2013	76151	SPEC ED TEACHER	Certificated	T03	05	T	A	1.00	43,611	1.00	48,678
EDN150/FA	11/27/2013	55340	EDUC ASST III	Y	SR12	03	P	A	0.50	12,226	0.50	13,005
EDN150/FA	11/28/2013	57463	EDUC ASST III	Y	SR12	03	P	A	0.75	20,609	0.75	21,915
EDN150/FA	11/28/2013	50857	EDUC ASST III	Y	SR12	03	P	A	0.75	21,407	0.75	22,823
EDN100/AA	11/28/2013	56821	SCHOOL SECURITY ATTENDANT	N	SR07	03	P	A	1.00	25,554	1.00	26,010
EDN150/FA	11/28/2013	57175	EDUC ASST III	Y	SR12	03	T	A	1.00	26,395	1.00	28,130
EDN150/SA	11/28/2013	35116	SPEECH PATHOLOGIST IV	Y	SR22	13	P	A	1.00	64,848	1.00	67,512
EDN150/YC	11/30/2013	59130	OFFICE ASSISTANT III	N	SR08	03	T	A	0.50	12,809	0.50	13,878
EDN150/YC	11/30/2013	59132	OFFICE ASSISTANT III	N	SR08	03	T	A	0.50	13,861	0.50	15,018
EDN400/MD	11/30/2013	9361	CAFETERIA HELPER	N	BC02	01	P	B			0.50	16,944
EDN400/MD	11/30/2013	50839	CAFETERIA HELPER	N	BC02	01	T	N	0.50	16,614	0.50	16,944
EDN100/AA	11/30/2013	37197	SCHOOL CUSTODIAN II	N	BC02	01	P	A	0.50	16,247	0.50	16,944
EDN150/FA	11/30/2013	45845	EDUC ASST III	Y	SR12	03	P	A	0.75	18,338	0.75	19,508
EDN100/AA	11/30/2013	802297	OFFICE ASSISTANT II	N	SR06	03	T	A			1.00	24,648
EDN400/MB	11/30/2013	801148	OFFICE ASSISTANT III	N	SR08	03	P	B	1.00	25,668	1.00	26,700
EDN100/AA	11/30/2013	29052	OFFICE ASSISTANT III	N	SR08	03	P	A	1.00	26,110	1.00	26,700
EDN150/FA	11/30/2013	54727	EDUC ASST III	Y	SR12	03	P	A	1.00	28,544	1.00	30,430
EDN100/AA	11/30/2013	11131	OFFICE ASSISTANT III	N	SR08	03	P	A	1.00	29,373	1.00	31,212
EDN100/AA	11/30/2013	600500	SECONDARY TEACHER	Certificated	T02	05	T	A	1.00	45,579	1.00	33,169
EDN100/AA	11/30/2013	16389	SCHOOL CUSTODIAN II	N	BC02	01	P	A	1.00	32,494	1.00	33,888
EDN100/AA	11/30/2013	17551	SCHOOL CUSTODIAN II	N	BC02	01	P	A	1.00	32,494	1.00	33,888
EDN100/AA	11/30/2013	16386	SCHOOL CUSTODIAN II	N	BC02	01	P	A	1.00	32,494	1.00	33,888
EDN100/AA	11/30/2013	16606	SCHOOL CUSTODIAN III	N	WS02	01	P	A	1.00	34,759	1.00	36,252
EDN100/AA	11/30/2013	16486	SCHOOL CUSTODIAN IV	N	F102	02	P	A	1.00	38,819	1.00	41,280
EDN150/YG	11/30/2013	802596	BEHAVIORAL HLTH SPCLT III	N	SR20	13	T	A			1.00	43,812
EDN300/UA	11/30/2013	30541	AUTOMATED SYSTEMS EQUIP SUPVR	N	F114	02	P	A	1.00	53,703	1.00	62,676
EDN100	7/1/2011	59652	PRE AUDIT CLERK I	N	SR11	03	T	N			1.00	28,836
EDN100	7/1/2011	800851	LEGAL ASSISTANT III	N	SR20	13	T	T			1.00	42,132
EDN100	8/19/2011	801103	PERSONNEL CLERK IV	N	SR11	03	T	N			1.00	28,836
EDN100	10/1/2011	75099	STATE OFFICE TEACHER	Certificated	T03	05	T	A			1.00	48,706
EDN100	1/4/2012	801105	PERSONNEL CLERK V	N	SR13	03	T	N			1.00	31,212
EDN100	5/1/2012	56391	OFFICE ASSISTANT V	N	SR12	03	T	N			1.00	35,064
EDN100	7/26/2012	79441	DIST OFF TCHR	Certificated	T07	05	T	N			1.00	59,818
EDN100	2/1/2013	64334	SECONDARY TEACHER	Certificated	T05	05	P	A	1.00	43,822	1.00	64,791
EDN100	5/29/2013	79404	DIST OFF TCHR	Certificated	T03	05	T	N			0.50	23,643

<u>Prog ID/Org</u>	<u>New Hire Effective Date</u>	<u>Position Number</u>	<u>Position Title</u>	<u>Exempt (Y/N)</u>	<u>SR Level</u>	<u>BU Code</u>	<u>T/P</u>	<u>MOF</u>	<u>Budgeted FTE</u>	<u>Budgeted Salary</u>	<u>Actual FTE</u>	<u>Actual Salary</u>
EDN100/AA	7/1/2011	36388	CLERK TYPIST II	N	SR08	03	P	A	1.00	37,968	1.00	13,327
EDN100/AA	7/1/2011	69953	SECONDARY TEACHER	Certificated	T02	05	P	A	1.00	49,448	1.00	43,157
EDN100/AA	7/1/2011	56540	CLERK TYPIST II	N	SR08	03	P	A	0.50	13,878	0.50	6,664
EDN100/AA	7/1/2011	73468	ELEM TEACHER	Certificated	T02	05	T	A	1.00	65,729	1.00	43,157
EDN100/AA	7/1/2011	72629	ELEM TEACHER	Certificated	T02	05	P	A	1.00	55,087	1.00	43,157
EDN100/AA	7/1/2011	801345	CLERK TYPIST II	N	SR08	03	T	A	1.00	25,668	1.00	13,327
EDN150/FA	7/1/2011	73922	SPEC ED TEACHER	Certificated	T02	05	P	A	1.00	49,448	1.00	42,509
EDN100/AA	7/1/2011	56578	CLERK TYPIST II	N	SR08	03	P	A	1.00	30,036	1.00	13,327
EDN100/AA	7/1/2011	73756	SECONDARY TEACHER	Certificated	T02	05	P	A	1.00	49,448	1.00	43,157
EDN100/AA	7/1/2011	71096	SECONDARY TEACHER	Certificated	T03	05	P	A	1.00	48,008	1.00	46,609
EDN100/AA	7/1/2011	69380	SECONDARY TEACHER	Certificated	T02	05	P	A	1.00	55,622	1.00	43,157
EDN100/AA	7/1/2011	74018	SECONDARY TEACHER	Certificated	T03	05	T	A	1.00	46,609	1.00	46,609
EDN100/AA	7/1/2011	56814	CLERK TYPIST II	N	SR08	03	P	A	1.00	28,836	1.00	13,327
EDN200/GN	7/1/2011	601079	COMPLEX AREA PERSONNEL SPECIALIST II	Certificated	E07	06	T	A			1.00	77,069
EDN100/AA	7/1/2011	75009	SECONDARY TEACHER	Certificated	T02	05	P	A	1.00	49,448	1.00	43,157
EDN100/AA	7/1/2011	802181	DP USER SUPPORT TECH II	N	SR15	03	T	A			1.00	17,528
EDN100/AA	7/1/2011	14710	CLERK TYPIST II	N	SR08	03	P	A	1.00	25,668	1.00	13,327
EDN100/AA	7/1/2011	60384	SECONDARY TEACHER	Certificated	T03	05	P	A	1.00	44,452	1.00	45,909
EDN100/AA	7/1/2011	72556	SECONDARY TEACHER	Certificated	T02	05	P	A	1.00	53,483	1.00	42,509
EDN150/FA	7/1/2011	600196	SPEC ED TEACHER	Certificated	T02	05	T	A			1.00	32,222
EDN100/AA	7/1/2011	76045	SECONDARY TEACHER	Certificated	T03	05	P	A	1.00	51,426	1.00	45,909
EDN150/FA	7/1/2011	60846	GEN EDUC/ARTICLE VI TCHR	Certificated	T02	05	P	A	1.00	49,448	1.00	43,157
EDN100/AA	7/1/2011	66435	ELEM TEACHER	Certificated	T02	05	P	A	1.00	46,609	1.00	42,509
EDN150/FA	7/1/2011	601422	GEN EDUC/ARTICLE VI TCHR	Certificated	T02	05	T	A			1.00	43,157
EDN100/AA	7/1/2011	601923	ELEM TEACHER	Certificated	T02	05	T	A			1.00	43,157
EDN100/AA	7/1/2011	72100	SECONDARY TEACHER	Certificated	T02	05	P	A	1.00	49,448	1.00	32,222
EDN100/AA	7/1/2011	71872	ELEM TEACHER	Certificated	T02	05	P	A	1.00	43,157	1.00	43,157
EDN100/AA	7/1/2011	71879	ELEM TEACHER	Certificated	T02	05	P	A	1.00	46,609	1.00	43,157
EDN150/FA	7/1/2011	76069	SPEC ED TEACHER	Certificated	T02	05	P	A	1.00	46,609	1.00	42,509
EDN150/FA	7/1/2011	71695	SPEC ED TEACHER	Certificated	T02	05	P	A	1.00	43,157	1.00	42,509
EDN150/FA	7/1/2011	61852	SPEC ED TEACHER	Certificated	T02	05	P	A	1.00	45,747	1.00	42,509
EDN150/FA	7/1/2011	74578	SPEC ED TEACHER	Certificated	T02	05	P	A	1.00	53,483	1.00	43,157
EDN150/YG	7/1/2011	801199	BEHAVIORAL HLTH SPCLT III	N	SR20	13	P	A	1.00	45,576	1.00	42,132
EDN100/AA	7/1/2011	67371	SECONDARY TEACHER	Certificated	T02	05	P	A	1.00	55,087	1.00	43,785
EDN100/BM	7/1/2011	52463	ATHLETIC HLTH CARE TRAINER	Y	SR22	13	P	A	1.00	45,576	1.00	45,576
EDN300/KO	7/1/2011	60046	ASST SUPT,HUMAN RES	N	E00	06	P	A	1.00	115,000	1.00	120,000
EDN100/BS	7/1/2011	73861	ROTC INSTRUCTOR	Certificated	ROTC	05	T	A	1.00	57,588	1.00	68,220
EDN100/AA	7/5/2011	59989	CLERK II	N	SR06	03	T	A			1.00	12,301
EDN100/AA	7/5/2011	802184	DP USER SUPPORT TECH II	N	SR15	03	T	A			1.00	17,528
EDN100/BM	7/5/2011	800185	ATHLETIC HLTH CARE TRAINER	Y	SR22	13	P	A	1.00	47,412	1.00	23,663
EDN100/AA	7/7/2011	802008	CLERK TYPIST II	N	SR08	03	T	A			0.50	12,834
EDN100/AA	7/11/2011	800701	CLERK TYPIST II	N	SR08	03	T	A	0.50	13,350	0.50	6,664
EDN100/AA	7/11/2011	16373	SCHOOL CUSTODIAN II	N	BC02	01	P	A	1.00	33,228	1.00	33,228
EDN100/AA	7/11/2011	40761	CLERK TYPIST II	N	SR08	03	P	A			1.00	13,327
EDN150/YC	7/11/2011	59137	CLERK TYPIST II	N	SR08	03	T	A	0.50	12,834	0.50	6,664
EDN100/AA	7/18/2011	16329	SCHOOL CUSTODIAN II	N	BC02	01	P	A	1.00	33,228	1.00	33,228
EDN100/AA	7/18/2011	801841	GEN PROF IV	N	SR22	13	T	A			0.50	11,831

Department of Education
New Hires

Table 16

<u>Prog ID/Org</u>	<u>New Hire Effective Date</u>	<u>Position Number</u>	<u>Position Title</u>	<u>Exempt (Y/N)</u>	<u>SR Level</u>	<u>BU Code</u>	<u>T/P</u>	<u>MOF</u>	<u>Budgeted FTE</u>	<u>Budgeted Salary</u>	<u>Actual FTE</u>	<u>Actual Salary</u>
EDN150/YC	7/18/2011	58628	BEHAVIORAL HLTH SPCLT III	N	SR20	13	P	A	1.00	45,576	1.00	42,132
EDN100/AA	7/18/2011	16572	SCHOOL CUSTODIAN III	N	WS02	01	P	A	1.00	35,544	1.00	35,544
EDN100/BM	7/18/2011	52467	ATHLETIC HLTH CARE TRAINER	Y	SR22	13	P	A	1.00	53,352	1.00	45,576
EDN100/AA	7/18/2011	55284	CLERK III	N	SR08	03	P	A	0.50	12,834	0.50	6,664
EDN150/FA	7/20/2011	74584	SPEC ED TEACHER	Certificated	T02	05	P	A	1.00	43,157	1.00	42,509
EDN150/YC	7/21/2011	58410	BEHAVIORAL HLTH SPCLT III	N	SR20	13	P	A	1.00	45,576	1.00	42,132
EDN400/MD	7/25/2011	9824	SCHOOL COOK II	N	BC06	01	P	A			1.00	38,436
EDN150/YC	7/25/2011	58630	BEHAVIORAL HLTH SPCLT III	N	SR20	13	P	A	1.00	45,576	1.00	42,132
EDN100/BM	7/25/2011	801120	ATHLETIC HLTH CARE TRAINER	Y	SR22	13	P	A	1.00	45,576	1.00	23,663
EDN400/MD	7/25/2011	9267	CAFETERIA HELPER	N	BC02	01	P	A			0.50	16,614
EDN400/MD	7/25/2011	54444	SCHOOL BAKER	N	BC06	01	P	A	1.00	38,436	1.00	19,958
EDN150/YC	7/25/2011	59636	BEHAVIORAL HLTH SPCLT III	N	SR20	13	T	A	1.00	45,576	1.00	21,881
EDN100/AA	7/26/2011	63410	SECONDARY TEACHER	Certificated	T02	05	P	A	1.00	57,324	1.00	32,222
EDN150/FA	7/26/2011	74407	SPEC ED TCHR/PRE-SCHOOL	Certificated	T02	05	P	A	1.00	49,448	1.00	42,509
EDN100/AA	7/26/2011	63517	SECONDARY TEACHER	Certificated	T02	05	T	A	0.50	16,982	1.00	32,222
EDN150/FA	7/26/2011	74422	SPEC ED TEACHER	Certificated	T03	05	P	A	1.00	45,785	1.00	45,909
EDN150/FA	7/26/2011	601845	GEN EDUC/ARTICLE VI TCHR	Certificated	T02	05	T	A			1.00	32,222
EDN150/FA	7/26/2011	600218	SPEC ED TEACHER	Certificated	T02	05	T	A			1.00	32,222
EDN100/AA	7/26/2011	75076	SECONDARY TEACHER	Certificated	T03	05	P	A	1.00	68,351	1.00	45,909
EDN100/AA	7/26/2011	600834	SECONDARY TEACHER	Certificated	T02	05	T	A			0.50	16,111
EDN150/FA	7/26/2011	71209	SPEC ED TEACHER	Certificated	T02	05	P	A	1.00	45,785	1.00	42,509
EDN150/FA	7/26/2011	602098	SPEC ED TEACHER	Certificated	T02	05	T	A			1.00	42,509
EDN100/AA	7/26/2011	60716	SECONDARY TEACHER	Certificated	T02	05	P	A	1.00	60,729	1.00	42,509
EDN150/FA	7/26/2011	62965	SPEC ED TEACHER	Certificated	T02	05	P	A	1.00	56,195	1.00	42,509
EDN100/AA	7/26/2011	63354	SECONDARY TEACHER	Certificated	T02	05	P	A	1.00	57,291	1.00	32,222
EDN100/AA	7/26/2011	29327	SCHOOL HEALTH AIDE	N	SR09	03	P	A	1.00	24,786	1.00	18,078
EDN100/AA	7/26/2011	63669	SECONDARY TEACHER	Certificated	T02	05	P	A	1.00	49,448	1.00	32,222
EDN100/AA	7/26/2011	68089	ELEM TEACHER	Certificated	T02	05	P	A	1.00	63,845	1.00	42,509
EDN100/AA	7/26/2011	67072	ELEM TEACHER	Certificated	T02	05	P	A	1.00	61,774	1.00	42,509
EDN100/AA	7/26/2011	68788	SECONDARY TEACHER	Certificated	T02	05	P	A	1.00	53,483	1.00	32,222
EDN100/AA	7/26/2011	68210	ELEM TEACHER	Certificated	T02	05	T	A	1.00	52,471	1.00	32,222
EDN100/AA	7/26/2011	600417	ELEM TEACHER	Certificated	T03	05	T	A			1.00	45,909
EDN100/AA	7/26/2011	63701	ELEM TEACHER	Certificated	T03	05	T	A	1.00	49,303	1.00	45,909
EDN150/FA	7/26/2011	71845	SPEC ED TCHR/PRE-SCHOOL	Certificated	T02	05	P	A	1.00	59,010	1.00	32,222
EDN100/AA	7/26/2011	601237	ELEM TEACHER	Certificated	T03	05	T	A			1.00	45,909
EDN100/AA	7/26/2011	60979	SECONDARY TEACHER	Certificated	T03	05	T	A	1.00	61,774	1.00	45,909
EDN150/FB	7/26/2011	75795	SPEC ED TEACHER	Certificated	T02	05	P	A	1.00	46,609	1.00	32,222
EDN100/AA	7/26/2011	65074	ELEM TEACHER	Certificated	T03	05	P	A	1.00	66,397	1.00	45,909
EDN100/AA	7/26/2011	601464	ELEM TEACHER	Certificated	T02	05	T	A			1.00	32,222
EDN150/FA	7/26/2011	73256	SPEC ED TEACHER	Certificated	T02	05	T	A	1.00	43,157	1.00	42,509
EDN100/AA	7/26/2011	71113	ELEM TEACHER	Certificated	T02	05	P	A	1.00	54,558	1.00	42,509
EDN100/AA	7/26/2011	72237	SECONDARY TEACHER	Certificated	T02	05	P	A	0.50	16,356	1.00	43,785
EDN100/AA	7/26/2011	67266	SECONDARY TEACHER	Certificated	T03	05	P	A	1.00	48,008	1.00	45,909
EDN100/AA	7/26/2011	65799	SECONDARY TEACHER	Certificated	T03	05	P	A	1.00	50,931	1.00	45,909
EDN100/AA	7/26/2011	62712	COUNSELOR	Certificated	T02	05	P	A	1.00	57,291	0.50	21,255
EDN150/FA	7/26/2011	601779	SPEC ED TEACHER	Certificated	T02	05	T	A			1.00	42,509
EDN150/FA	7/26/2011	69689	SPEC ED TEACHER	Certificated	T03	05	P	A	1.00	46,830	1.00	45,909

<u>Prog ID/Org</u>	<u>New Hire Effective Date</u>	<u>Position Number</u>	<u>Position Title</u>	<u>Exempt (Y/N)</u>	<u>SR Level</u>	<u>BU Code</u>	<u>T/P</u>	<u>MOF</u>	<u>Budgeted FTE</u>	<u>Budgeted Salary</u>	<u>Actual FTE</u>	<u>Actual Salary</u>
EDN150/FA	7/26/2011	600388	SPEC ED TEACHER	Certificated	T02	05	T	A			1.00	42,509
EDN150/FA	7/26/2011	64862	SPEC ED TEACHER	Certificated	T03	05	P	A	1.00	46,830	1.00	45,909
EDN100/AA	7/26/2011	69742	SECONDARY TEACHER	Certificated	T03	05	P	A	1.00	50,743	1.00	45,909
EDN150/FA	7/26/2011	75953	GEN EDUC/ARTICLE VI TCHR	Certificated	T02	05	P	A	1.00	54,033	1.00	42,509
EDN100/AA	7/26/2011	601799	SECONDARY TEACHER	Certificated	T02	05	T	A			0.50	21,255
EDN100/AA	7/26/2011	602239	ELEM TEACHER	Certificated	T03	05	T	A			1.00	45,909
EDN100/AA	7/26/2011	601921	SECONDARY TEACHER	Certificated	T02	05	T	A			1.00	42,509
EDN100/AA	7/26/2011	600844	SECONDARY TEACHER	Certificated	T02	05	T	A			1.00	42,509
EDN150/FA	7/26/2011	65437	GEN EDUC/ARTICLE VI TCHR	Certificated	T02	05	P	A	1.00	47,654	1.00	43,157
EDN100/AA	7/26/2011	60495	ELEM TEACHER	Certificated	T02	05	P	A	1.00	49,448	1.00	42,509
EDN150/FA	7/26/2011	75563	SPEC ED TCHR/PRE-SCHOOL	Certificated	T02	05	T	A	1.00	46,609	1.00	42,509
EDN150/FA	7/26/2011	600006	DIST OFF TCHR	Certificated	T02	05	T	A			1.00	32,222
EDN100/AA	7/26/2011	66255	ELEM TEACHER	Certificated	T03	05	P	A	1.00	68,408	1.00	45,909
EDN150/FA	7/26/2011	61372	SPEC ED TEACHER	Certificated	T03	05	P	A	1.00	32,713	1.00	45,909
EDN150/FA	7/26/2011	74560	SPEC ED TEACHER	Certificated	T02	05	P	A	1.00	52,968	1.00	32,222
EDN150/FA	7/26/2011	64984	SPEC ED TEACHER	Certificated	T03	05	P	A	1.00	49,448	1.00	45,909
EDN100/AA	7/26/2011	602066	ELEM TEACHER	Certificated	T03	05	P	A			1.00	45,909
EDN100/AA	7/26/2011	600835	ELEM TEACHER	Certificated	T02	05	T	A			1.00	42,509
EDN100/AA	7/26/2011	64054	ELEM TEACHER	Certificated	T03	05	P	A	1.00	68,408	1.00	45,909
EDN100/AA	7/26/2011	71517	ELEM TEACHER	Certificated	T03	05	P	A	1.00	62,550	1.00	46,609
EDN100/AA	7/26/2011	601721	ELEM TEACHER	Certificated	T03	05	T	A			1.00	45,909
EDN100/AA	7/26/2011	60277	ELEM TEACHER	Certificated	T02	05	P	A	1.00	50,931	1.00	42,509
EDN100/DB	7/26/2011	79535	SECONDARY TEACHER	Certificated	T03	05	T	N			1.00	45,909
EDN150/FA	7/26/2011	69412	SPEC ED TEACHER	Certificated	T03	05	P	A	1.00	43,157	1.00	45,909
EDN100/AA	7/26/2011	74860	ELEM TEACHER	Certificated	T02	05	P	A	1.00	45,785	1.00	42,509
EDN100/AA	7/26/2011	61153	ELEM TEACHER	Certificated	T02	05	P	A	1.00	50,931	1.00	42,509
EDN100/AA	7/26/2011	71711	ELEM TEACHER	Certificated	T03	05	P	A	1.00	53,755	1.00	45,909
EDN100/AA	7/26/2011	601733	SECONDARY TEACHER	Certificated	T02	05	T	A			1.00	42,509
EDN150/NB	7/26/2011	600815	DIST OFF TCHR	Certificated	T02	05	T	N			1.00	42,509
EDN100/AA	7/26/2011	68821	SECONDARY TEACHER	Certificated	T02	05	P	A	1.00	74,688	1.00	43,157
EDN150/FA	7/26/2011	68548	SPEC ED TEACHER	Certificated	T02	05	P	A	1.00	62,550	1.00	42,509
EDN150/FA	7/26/2011	61989	SPEC ED TEACHER	Certificated	T02	05	P	A	1.00	47,159	1.00	42,509
EDN150/FA	7/26/2011	63150	SPEC ED TEACHER	Certificated	T02	05	P	A	1.00	70,400	1.00	32,222
EDN100/AA	7/26/2011	601402	SECONDARY TEACHER	Certificated	T03	05	T	A			1.00	45,909
EDN100/AA	7/26/2011	67775	ELEM TEACHER	Certificated	T02	05	P	A	1.00	48,008	1.00	42,509
EDN100/AA	7/26/2011	68072	ELEM TEACHER	Certificated	T02	05	T	A	1.00	52,968	1.00	42,509
EDN100/AA	7/26/2011	68182	SECONDARY TEACHER	Certificated	T02	05	P	A	1.00	49,448	1.00	32,222
EDN100/AA	7/26/2011	66036	ELEM TEACHER	Certificated	T02	05	P	A	1.00	49,053	1.00	42,509
EDN100/AA	7/26/2011	61000	ELEM TEACHER	Certificated	T03	05	P	A	1.00	45,747	1.00	45,909
EDN100/AA	7/26/2011	64804	SECONDARY TEACHER	Certificated	T03	05	P	A	1.00	74,688	1.00	45,909
EDN100/AA	7/26/2011	69106	SECONDARY TEACHER	Certificated	T02	05	P	A	0.50	34,176	1.00	42,509
EDN100/AA	7/26/2011	62047	SECONDARY TEACHER	Certificated	T03	05	P	A	1.00	51,426	1.00	47,287
EDN150/FA	7/26/2011	64442	SPEC ED TCHR/PRE-SCHOOL	Certificated	T03	05	P	A	1.00	43,157	1.00	45,909
EDN150/FA	7/26/2011	74869	SPEC ED TEACHER	Certificated	T03	05	P	A	1.00	49,448	1.00	45,909
EDN100/AA	7/26/2011	62741	ELEM TEACHER	Certificated	T03	05	P	A	1.00	44,452	1.00	45,909
EDN100/DB	7/26/2011	69415	SECONDARY TEACHER	Certificated	T03	05	T	N			1.00	45,909
EDN150/FA	7/26/2011	71291	SPEC ED TEACHER	Certificated	T02	05	P	A	1.00	46,609	1.00	42,509

<u>Prog ID/Org</u>	<u>New Hire Effective Date</u>	<u>Position Number</u>	<u>Position Title</u>	<u>Exempt (Y/N)</u>	<u>SR Level</u>	<u>BU Code</u>	<u>T/P</u>	<u>MOF</u>	<u>Budgeted FTE</u>	<u>Budgeted Salary</u>	<u>Actual FTE</u>	<u>Actual Salary</u>
EDN100/AA	7/26/2011	67570	ELEM TEACHER	Certificated	T02	05	P	A	1.00	72,513	1.00	42,509
EDN150/FA	7/26/2011	62234	SPEC ED TEACHER	Certificated	T02	05	P	A	1.00	53,483	1.00	43,785
EDN100/AA	7/26/2011	601679	SECONDARY TEACHER	Certificated	T03	05	T	A			1.00	45,909
EDN100/AA	7/26/2011	61184	SECONDARY TEACHER	Certificated	T03	05	P	A	1.00	65,004	1.00	45,909
EDN100/AA	7/26/2011	67892	ELEM TEACHER	Certificated	T03	05	P	A	1.00	59,010	1.00	45,909
EDN100/AA	7/26/2011	65158	ELEM TEACHER	Certificated	T03	05	P	A	1.00	51,426	1.00	45,909
EDN100/AA	7/26/2011	600641	ELEM TEACHER	Certificated	T03	05	T	A			1.00	45,909
EDN150/FA	7/26/2011	600780	GEN EDUC/ARTICLE VI TCHR	Certificated	T02	05	T	A			1.00	42,509
EDN100/AA	7/26/2011	29494	SCHOOL HEALTH AIDE	N	SR09	03	P	A	1.00	22,919	1.00	13,867
EDN100/AA	7/26/2011	74213	SECONDARY TEACHER	Certificated	T02	05	P	A	1.00	63,861	1.00	42,509
EDN150/FA	7/26/2011	66748	SPEC ED TEACHER	Certificated	T03	05	T	A	1.00	58,959	1.00	45,909
EDN100/AA	7/26/2011	602244	ELEM TEACHER	Certificated	T02	05	T	A			1.00	32,222
EDN100/AA	7/26/2011	74502	SECONDARY TEACHER	Certificated	T03	05	P	A	1.00	49,448	1.00	46,609
EDN100/AA	7/26/2011	602248	ELEM TEACHER	Certificated	T03	05	T	A			1.00	45,909
EDN100/AA	7/26/2011	69703	ELEM TEACHER	Certificated	T02	05	P	A	1.00	56,917	1.00	42,509
EDN100/AA	7/26/2011	69468	ELEM TEACHER	Certificated	T03	05	P	A	1.00	60,729	1.00	45,909
EDN100/AA	7/26/2011	602250	COUNSELOR	Certificated	T02	05	T	A			1.00	42,509
EDN100/AA	7/26/2011	69047	SECONDARY TEACHER	Certificated	T03	05	T	A	1.00	45,785	1.00	45,909
EDN150/FA	7/26/2011	72107	GEN EDUC/ARTICLE VI TCHR	Certificated	T02	05	P	A	1.00	58,959	1.00	42,509
EDN100/AA	7/26/2011	60164	ELEM TEACHER	Certificated	T02	05	P	A	1.00	65,778	1.00	42,509
EDN100/AA	7/26/2011	62222	ELEM TEACHER	Certificated	T03	05	P	A	1.00	54,558	1.00	45,909
EDN100/AA	7/26/2011	601697	SECONDARY TEACHER	Certificated	T03	05	T	A			1.00	45,909
EDN100/AA	7/26/2011	63205	SECONDARY TEACHER	Certificated	T02	05	T	A	1.00	70,400	1.00	42,509
EDN100/AA	7/26/2011	65429	SECONDARY TEACHER	Certificated	T02	05	P	A	1.00	50,493	1.00	32,222
EDN150/FA	7/26/2011	74377	SPEC ED TEACHER	Certificated	T02	05	P	A	1.00	52,471	1.00	32,222
EDN100/AA	7/26/2011	66574	ELEM TEACHER	Certificated	T02	05	P	A	1.00	57,324	1.00	42,509
EDN100/BJ	7/26/2011	602029	SPEC ED TEACHER	Certificated	T02	05	T	A			1.00	32,222
EDN100/AA	7/26/2011	600438	10-MO STUDENT SVCS COORD	Certificated	T03	05	T	A			0.50	22,955
EDN100/AA	7/26/2011	66011	ELEM TEACHER	Certificated	T02	05	P	A	1.00	73,808	1.00	42,509
EDN150/FA	7/26/2011	75922	GEN EDUC/ARTICLE VI TCHR	Certificated	T02	05	P	A	1.00	45,785	1.00	32,222
EDN100/AA	7/26/2011	63271	SECONDARY TEACHER	Certificated	T03	05	P	A	1.00	45,785	1.00	45,909
EDN100/AA	7/26/2011	600697	ELEM TEACHER	Certificated	T03	05	T	A			1.00	45,909
EDN100/AA	7/26/2011	600739	SECONDARY TEACHER	Certificated	T02	05	T	A			1.00	42,509
EDN150/FA	7/26/2011	75663	GEN EDUC/ARTICLE VI TCHR	Certificated	T02	05	T	A			1.00	42,509
EDN150/FA	7/26/2011	63387	SPEC ED TEACHER	Certificated	T02	05	P	A	1.00	60,729	1.00	32,222
EDN150/FA	7/26/2011	600781	GEN EDUC/ARTICLE VI TCHR	Certificated	T02	05	T	A			1.00	42,509
EDN100/AA	7/26/2011	600845	SECONDARY TEACHER	Certificated	T02	05	T	A			1.00	42,509
EDN150/FA	7/26/2011	67310	SPEC ED TEACHER	Certificated	T02	05	P	A	1.00	43,157	1.00	42,509
EDN150/FA	7/26/2011	73585	SPEC ED TEACHER	Certificated	T03	05	P	A	1.00	43,157	1.00	45,909
EDN150/FA	7/26/2011	72789	SPEC ED TCHR/PRE-SCHOOL	Certificated	T03	05	P	A	1.00	46,609	1.00	45,909
EDN100/AA	7/26/2011	62651	SECONDARY TEACHER	Certificated	T03	05	P	A	1.00	60,729	1.00	45,909
EDN100/AA	7/26/2011	71337	SECONDARY TEACHER	Certificated	T03	05	P	A	1.00	48,008	1.00	45,909
EDN100/AA	7/26/2011	602039	SECONDARY TEACHER	Certificated	T03	05	T	A			1.00	47,287
EDN150/FA	7/26/2011	68387	SPEC ED TEACHER	Certificated	T03	05	T	A	1.00	48,008	1.00	45,909
EDN100/DB	7/26/2011	79831	ELEM TEACHER	Certificated	T03	05	T	N			1.00	47,287
EDN150/FA	7/26/2011	68044	SPEC ED TEACHER	Certificated	T02	05	P	A	1.00	75,733	1.00	42,509
EDN100/AA	7/26/2011	602242	SECONDARY TEACHER	Certificated	T03	05	T	A			1.00	45,909

<u>Prog ID/Org</u>	<u>New Hire Effective Date</u>	<u>Position Number</u>	<u>Position Title</u>	<u>Exempt (Y/N)</u>	<u>SR Level</u>	<u>BU Code</u>	<u>T/P</u>	<u>MOF</u>	<u>Budgeted FTE</u>	<u>Budgeted Salary</u>	<u>Actual FTE</u>	<u>Actual Salary</u>
EDN150/FA	7/26/2011	76344	SPEC ED TEACHER	Certificated	T02	05	P	A	1.00	55,087	1.00	42,509
EDN100/AA	7/26/2011	60738	SECONDARY TEACHER	Certificated	T02	05	P	A	1.00	61,774	1.00	43,157
EDN150/FA	7/26/2011	75902	GEN EDUC/ARTICLE VI TCHR	Certificated	T02	05	P	A	1.00	51,758	1.00	32,222
EDN100/AA	7/26/2011	62761	ELEM TEACHER	Certificated	T02	05	P	A	1.00	72,513	1.00	42,509
EDN150/FA	7/26/2011	62382	GEN EDUC/ARTICLE VI TCHR	Certificated	T03	05	P	A	1.00	46,609	1.00	45,909
EDN100/AA	7/26/2011	64947	ELEM TEACHER	Certificated	T02	05	P	A	1.00	49,448	1.00	42,509
EDN150/FA	7/26/2011	63219	GEN EDUC/ARTICLE VI TCHR	Certificated	T02	05	P	A	1.00	70,400	1.00	43,785
EDN150/FA	7/26/2011	67197	SPEC ED TEACHER	Certificated	T02	05	P	A	1.00	49,448	1.00	43,785
EDN100/AA	7/26/2011	61946	SECONDARY TEACHER	Certificated	T03	05	P	A	1.00	68,351	1.00	45,909
EDN100/AA	7/26/2011	68857	SECONDARY TEACHER	Certificated	T02	05	P	A	1.00	46,609	1.00	43,157
EDN100/AA	7/26/2011	67629	ELEM TEACHER	Certificated	T03	05	P	A	1.00	43,157	1.00	45,909
EDN100/AA	7/26/2011	802193	SCHOOL CUSTODIAN II	N	BC02	01	P	A			0.50	8,629
EDN100/AA	7/26/2011	29398	SCHOOL HEALTH AIDE	N	SR09	03	P	A	1.00	19,620	1.00	17,176
EDN100/AA	7/26/2011	64494	COUNSELOR	Certificated	T03	05	P	A	1.00	56,740	1.00	45,909
EDN100/AA	7/26/2011	602284	SPEC ED TEACHER	Certificated	T03	05	T	A			1.00	47,287
EDN100/AA	7/26/2011	601492	SECONDARY TEACHER	Certificated	T02	05	T	A			1.00	39,958
EDN100/AA	7/26/2011	64032	ELEM TEACHER	Certificated	T02	05	P	A	1.00	45,785	1.00	42,509
EDN150/FA	7/26/2011	67812	SPEC ED TEACHER	Certificated	T02	05	P	A	1.00	46,609	1.00	32,222
EDN100/AA	7/26/2011	66182	COUNSELOR	Certificated	T02	05	P	A	1.00	48,008	1.00	42,509
EDN100/AA	7/26/2011	63524	SECONDARY TEACHER	Certificated	T02	05	P	A	1.00	58,959	1.00	42,509
EDN100/AA	7/26/2011	69889	ELEM TEACHER	Certificated	T03	05	P	A	1.00	70,400	1.00	45,909
EDN100/AA	7/26/2011	60585	ELEM TEACHER	Certificated	T03	05	P	A	1.00	51,426	1.00	45,909
EDN100/BJ	7/26/2011	73176	SECONDARY TEACHER	Certificated	T03	05	P	A			1.00	45,909
EDN150/FA	7/26/2011	66472	SPEC ED TEACHER	Certificated	T02	05	P	A	1.00	62,550	1.00	42,509
EDN100/AA	7/26/2011	601066	ELEM TEACHER	Certificated	T02	05	T	A			1.00	42,509
EDN100/AA	7/26/2011	602352	ELEM TEACHER	Certificated	T03	05	T	A			1.00	45,909
EDN100/AA	7/26/2011	61555	ELEM TEACHER	Certificated	T02	05	T	A	1.00	58,959	1.00	32,222
EDN100/AA	7/26/2011	63566	SECONDARY TEACHER	Certificated	T02	05	P	A	1.00	62,639	1.00	32,222
EDN100/AA	7/26/2011	67727	ELEM TEACHER	Certificated	T03	05	P	A	1.00	60,088	1.00	45,909
EDN150/FA	7/26/2011	73514	SPEC ED TEACHER	Certificated	T03	05	P	A			1.00	46,609
EDN100/AA	7/26/2011	63241	SECONDARY TEACHER	Certificated	T02	05	P	A	1.00	60,779	1.00	42,509
EDN100/AA	7/26/2011	65987	ELEM TEACHER	Certificated	T03	05	P	A	1.00	49,448	1.00	45,909
EDN100/AA	7/26/2011	66775	ELEM TEACHER	Certificated	T02	05	P	A	1.00	56,740	1.00	42,509
EDN100/AA	7/26/2011	66602	COUNSELOR/HIGH RISK	Certificated	T03	05	P	A	1.00	64,482	1.00	45,909
EDN100/DB	7/26/2011	79248	SECONDARY TEACHER	Certificated	T03	05	T	N			1.00	45,909
EDN100/AA	7/26/2011	67063	SECONDARY TEACHER	Certificated	T03	05	T	A	1.00	51,426	0.50	22,955
EDN100/AA	7/26/2011	602286	ELEM TEACHER	Certificated	T03	05	T	A			1.00	45,909
EDN100/AA	7/26/2011	63659	ELEM TEACHER	Certificated	T02	05	P	A	1.00	45,785	1.00	42,509
EDN100/AA	7/26/2011	602338	ELEM TEACHER	Certificated	T02	05	T	A			1.00	42,509
EDN100/AA	7/26/2011	65663	ELEM TEACHER	Certificated	T03	05	P	A	1.00	43,157	1.00	45,909
EDN100/AA	7/26/2011	64131	ELEM TEACHER	Certificated	T03	05	P	A	1.00	62,550	1.00	45,909
EDN100/AA	7/26/2011	74243	SECONDARY TEACHER	Certificated	T02	05	P	A	1.00	32,713	1.00	32,222
EDN100/AA	7/26/2011	65450	SECONDARY TEACHER	Certificated	T03	05	P	A	1.00	54,528	1.00	45,909
EDN100/AA	7/26/2011	67986	ELEM TEACHER	Certificated	T03	05	P	A	1.00	72,513	1.00	45,909
EDN150/FB	7/26/2011	60268	SPECIAL SCH TEACHER	Certificated	T02	05	P	A	1.00	48,008	1.00	32,713
EDN100/AA	7/26/2011	66861	SECONDARY TEACHER	Certificated	T03	05	P	A	1.00	45,785	1.00	45,909
EDN100/AA	7/26/2011	72658	ELEM TEACHER	Certificated	T02	05	P	A	1.00	79,170	1.00	42,509

Department of Education
New Hires

Table 16

<u>Prog ID/Org</u>	<u>New Hire Effective Date</u>	<u>Position Number</u>	<u>Position Title</u>	<u>Exempt (Y/N)</u>	<u>SR Level</u>	<u>BU Code</u>	<u>T/P</u>	<u>MOF</u>	<u>Budgeted FTE</u>	<u>Budgeted Salary</u>	<u>Actual FTE</u>	<u>Actual Salary</u>
EDN100/AA	7/26/2011	62568	SECONDARY TEACHER	Certificated	T02	05	P	A	1.00	62,550	1.00	42,509
EDN150/FA	7/26/2011	76131	GEN EDUC/ARTICLE VI TCHR	Certificated	T03	05	P	A	1.00	44,452	1.00	47,287
EDN100/AA	7/26/2011	66219	SECONDARY TEACHER	Certificated	T03	05	P	A	1.00	46,609	1.00	45,909
EDN100/AA	7/26/2011	72411	SECONDARY TEACHER	Certificated	T03	05	P	A	1.00	79,170	1.00	47,287
EDN150/FA	7/26/2011	61505	SPEC ED TEACHER	Certificated	T02	05	P	A	1.00	43,157	1.00	39,958
EDN150/FA	7/26/2011	69324	GEN EDUC/ARTICLE VI TCHR	Certificated	T02	05	P	A	1.00	43,157	1.00	42,509
EDN100/AA	7/26/2011	601637	ELEM TEACHER	Certificated	T03	05	T	A			1.00	45,909
EDN100/AA	7/26/2011	601570	ELEM TEACHER	Certificated	T03	05	T	A			1.00	45,909
EDN100/AA	7/26/2011	68076	ELEM TEACHER	Certificated	T03	05	P	A	1.00	46,609	1.00	45,909
EDN100/AA	7/26/2011	60568	ELEM TEACHER	Certificated	T02	05	T	A	1.00	49,448	1.00	42,509
EDN150/FA	7/26/2011	67128	SPEC ED TEACHER	Certificated	T03	05	P	A	1.00	66,359	1.00	46,609
EDN100/AA	7/26/2011	68263	ELEM TEACHER	Certificated	T03	05	P	A	1.00	51,426	1.00	47,287
EDN150/FA	7/26/2011	600308	SPEC ED TEACHER	Certificated	T02	05	T	A			1.00	42,509
EDN150/FA	7/26/2011	74592	GEN EDUC/ARTICLE VI TCHR	Certificated	T03	05	P	A	1.00	74,688	1.00	46,609
EDN150/FA	7/26/2011	73678	SPEC ED TCHR/PRE-SCHOOL	Certificated	T02	05	P	A	1.00	51,426	1.00	32,222
EDN100/AA	7/26/2011	72207	ELEM TEACHER	Certificated	T02	05	P	A	1.00	52,460	1.00	42,509
EDN150/FA	7/26/2011	601825	SPEC ED TEACHER	Certificated	T03	05	T	A			1.00	45,909
EDN100/AA	7/26/2011	601465	ELEM TEACHER	Certificated	T02	05	T	A			1.00	42,509
EDN150/FA	7/26/2011	74762	SPEC ED TEACHER	Certificated	T03	05	P	A	1.00	51,426	1.00	45,909
EDN100/AA	7/26/2011	63544	ELEM TEACHER	Certificated	T03	05	P	A	1.00	45,785	1.00	45,909
EDN150/FA	7/26/2011	601891	SPEC ED TEACHER	Certificated	T02	05	T	A			1.00	42,509
EDN100/AA	7/26/2011	71631	ELEM TEACHER	Certificated	T02	05	P	A	0.50	24,724	0.50	21,893
EDN100/AA	7/26/2011	601633	ELEM TEACHER	Certificated	T03	05	T	A			1.00	45,909
EDN100/AA	7/26/2011	72298	ELEM TEACHER	Certificated	T03	05	P	A	1.00	69,396	1.00	45,909
EDN100/AA	7/26/2011	72105	SECONDARY TEACHER	Certificated	T02	05	P	A	1.00	46,609	1.00	42,509
EDN100/AA	7/26/2011	63017	SECONDARY TEACHER	Certificated	T03	05	P	A	1.00	49,448	1.00	47,287
EDN100/AA	7/26/2011	69796	ELEM TEACHER	Certificated	T03	05	P	A	1.00	62,550	1.00	45,909
EDN100/AA	7/26/2011	69194	SECONDARY TEACHER	Certificated	T02	05	P	A	1.00	45,785	1.00	42,509
EDN150/FA	7/26/2011	75520	SPEC ED TEACHER	Certificated	T03	05	T	A			1.00	45,909
EDN150/FA	7/26/2011	72812	SPEC ED TEACHER	Certificated	T02	05	P	A	1.00	32,713	1.00	42,509
EDN100/AA	7/26/2011	64297	ELEM TEACHER	Certificated	T03	05	P	A	1.00	49,448	1.00	45,909
EDN100/AA	7/26/2011	63806	ELEM TEACHER	Certificated	T02	05	P	A	1.00	62,550	1.00	42,509
EDN100/AA	7/26/2011	601297	SECONDARY TEACHER	Certificated	T03	05	T	A			1.00	45,909
EDN100/AA	7/26/2011	69327	SECONDARY TEACHER	Certificated	T03	05	P	A	1.00	46,609	1.00	45,909
EDN100/AA	7/26/2011	600236	ELEM TEACHER	Certificated	T03	05	T	A			1.00	45,909
EDN100/DB	7/26/2011	79845	SECONDARY TEACHER	Certificated	T02	05	T	N			1.00	42,509
EDN100/AA	7/26/2011	67755	SECONDARY TEACHER	Certificated	T02	05	P	A	1.00	48,705	1.00	42,509
EDN150/FA	7/26/2011	72269	SPEC ED TEACHER	Certificated	T03	05	P	A	1.00	60,254	1.00	45,909
EDN100/AA	7/26/2011	66870	SECONDARY TEACHER	Certificated	T02	05	P	A	1.00	37,481	1.00	42,509
EDN100/AA	7/26/2011	601436	SECONDARY TEACHER	Certificated	T02	05	T	A			1.00	42,509
EDN150/FA	7/26/2011	73289	SPEC ED TCHR/PRE-SCHOOL	Certificated	T03	05	P	A	1.00	68,408	1.00	46,609
EDN100/AA	7/26/2011	65659	SECONDARY TEACHER	Certificated	T02	05	P	A	1.00	48,008	1.00	42,509
EDN150/FA	7/26/2011	63222	SPEC ED TEACHER	Certificated	T02	05	P	A	1.00	45,785	1.00	42,509
EDN150/FA	7/26/2011	601595	SPEC ED TEACHER	Certificated	T03	05	T	A			1.00	45,909
EDN100/AA	7/26/2011	60927	ELEM TEACHER	Certificated	T03	05	P	A	1.00	43,157	1.00	45,909
EDN100/AA	7/26/2011	69799	ELEM TEACHER	Certificated	T02	05	P	A	1.00	58,959	1.00	42,509
EDN100/AA	7/26/2011	61937	SECONDARY TEACHER	Certificated	T03	05	P	A	1.00	56,740	1.00	45,909

Department of Education
New Hires

Table 16

<u>Prog ID/Org</u>	<u>New Hire Effective Date</u>	<u>Position Number</u>	<u>Position Title</u>	<u>Exempt (Y/N)</u>	<u>SR Level</u>	<u>BU Code</u>	<u>T/P</u>	<u>MOF</u>	<u>Budgeted FTE</u>	<u>Budgeted Salary</u>	<u>Actual FTE</u>	<u>Actual Salary</u>
EDN150/FA	7/26/2011	73220	SPEC ED TEACHER	Certificated	T03	05	P	A	1.00	43,157	1.00	45,909
EDN100/BB	7/26/2011	60721	SECONDARY TEACHER	Certificated	T03	05	P	A	1.00	50,743	1.00	45,909
EDN150/FA	7/26/2011	601138	SPEC ED TEACHER	Certificated	T02	05	T	A			1.00	42,509
EDN100/AA	7/26/2011	600056	ELEM TEACHER	Certificated	T02	05	T	A			1.00	42,509
EDN100/AA	7/26/2011	75077	SECONDARY TEACHER	Certificated	T03	05	P	A	1.00	60,729	1.00	47,287
EDN100/AA	7/26/2011	64752	ELEM TEACHER	Certificated	T02	05	P	A	1.00	53,483	1.00	42,509
EDN100/DB	7/26/2011	79542	ELEM TEACHER	Certificated	T02	05	T	N			1.00	42,509
EDN100/DB	7/26/2011	68767	ELEM TEACHER	Certificated	T03	05	T	N			1.00	45,909
EDN100/AA	7/26/2011	61923	SECONDARY TEACHER	Certificated	T03	05	P	A	1.00	72,513	1.00	45,909
EDN100/AA	7/26/2011	60289	SECONDARY TEACHER	Certificated	T03	05	P	A	1.00	69,396	1.00	45,909
EDN100/AA	7/26/2011	66202	SECONDARY TEACHER	Certificated	T03	05	P	A	1.00	49,448	1.00	45,909
EDN100/BV	7/26/2011	74897	SECONDARY TEACHER	Certificated	T02	05	T	A	1.00	45,785	1.00	42,509
EDN100/AA	7/26/2011	601567	ELEM TEACHER	Certificated	T02	05	T	A			1.00	42,509
EDN150/FA	7/26/2011	71151	SPEC ED TEACHER	Certificated	T02	05	P	A	1.00	43,157	1.00	42,509
EDN100/AA	7/26/2011	600699	ELEM TEACHER	Certificated	T02	05	T	A			1.00	42,509
EDN100/AA	7/26/2011	74852	ELEM TEACHER	Certificated	T02	05	P	A	1.00	64,427	1.00	42,509
EDN100/AA	7/26/2011	68307	SECONDARY TEACHER	Certificated	T02	05	P	A	1.00	52,460	1.00	43,157
EDN100/AA	7/26/2011	73370	SECONDARY TEACHER	Certificated	T02	05	P	A	1.00	68,351	1.00	42,509
EDN150/FA	7/26/2011	60304	SPEC ED TEACHER	Certificated	T02	05	P	A	1.00	32,713	1.00	42,509
EDN150/FA	7/26/2011	74333	SPEC ED TEACHER	Certificated	T02	05	P	A	1.00	43,157	1.00	43,157
EDN100/AA	7/26/2011	69969	SECONDARY TEACHER	Certificated	T03	05	P	A	1.00	44,452	1.00	45,909
EDN100/AA	7/26/2011	63575	ELEM TEACHER	Certificated	T02	05	P	A	1.00	48,008	1.00	42,509
EDN100/AA	7/26/2011	65705	ELEM TEACHER	Certificated	T03	05	P	A	1.00	49,448	1.00	45,909
EDN100/AA	7/26/2011	68175	SECONDARY TEACHER	Certificated	T02	05	P	A	1.00	49,448	1.00	32,222
EDN100/AA	7/26/2011	601273	SECONDARY TEACHER	Certificated	T02	05	T	A			1.00	42,509
EDN100/BV	7/26/2011	64816	SECONDARY TEACHER	Certificated	T03	05	T	A	1.00	57,785	1.00	45,909
EDN100/BV	7/26/2011	63194	ELEM TEACHER	Certificated	T02	05	P	A	1.00	32,713	1.00	32,222
EDN150/FA	7/26/2011	63950	SPEC ED TCHR/PRE-SCHOOL	Certificated	T02	05	P	A	1.00	72,513	1.00	42,509
EDN100/AA	7/26/2011	60516	ELEM TEACHER	Certificated	T02	05	T	A	1.00	53,483	1.00	42,509
EDN100/AA	7/26/2011	72148	ELEM TEACHER	Certificated	T02	05	T	A	1.00	45,785	1.00	42,509
EDN150/FA	7/26/2011	76065	SPEC ED TCHR/PRE-SCHOOL	Certificated	T02	05	P	A	1.00	45,785	1.00	32,222
EDN100/AA	7/26/2011	601210	ELEM TEACHER	Certificated	T02	05	T	A			1.00	42,509
EDN100/AA	7/26/2011	69877	SECONDARY TEACHER	Certificated	T03	05	P	A	1.00	79,170	1.00	45,909
EDN100/AA	7/26/2011	71528	ELEM TEACHER	Certificated	T03	05	P	A	1.00	58,959	1.00	45,909
EDN150/FA	7/26/2011	73206	SPEC ED TEACHER	Certificated	T02	05	P	A	1.00	56,132	1.00	32,222
EDN100/AA	7/26/2011	600851	ELEM TEACHER	Certificated	T02	05	T	A			1.00	42,509
EDN100/AA	7/26/2011	60709	ELEM TEACHER	Certificated	T02	05	T	A	0.50	24,724	0.50	21,255
EDN150/FA	7/26/2011	68341	GEN EDUC/ARTICLE VI TCHR	Certificated	T02	05	P	A	1.00	50,743	1.00	42,509
EDN100/AA	7/26/2011	601443	ELEM TEACHER	Certificated	T02	05	T	A			1.00	43,157
EDN100/AA	7/26/2011	601592	ELEM TEACHER	Certificated	T02	05	T	A			1.00	42,509
EDN100/AA	7/26/2011	600733	SECONDARY TEACHER	Certificated	T02	05	T	A			1.00	32,222
EDN100/AA	7/26/2011	601425	SECONDARY TEACHER	Certificated	T03	05	T	A			1.00	45,909
EDN100/AA	7/26/2011	601474	ELEM TEACHER	Certificated	T02	05	T	A			1.00	43,157
EDN100/AA	7/26/2011	601764	ELEM TEACHER	Certificated	T02	05	T	A			1.00	42,509
EDN150/FA	7/26/2011	73215	SPEC ED TEACHER	Certificated	T03	05	P	A			1.00	45,909
EDN100/AA	7/26/2011	62815	ELEM TEACHER	Certificated	T03	05	P	A	1.00	79,170	1.00	45,909
EDN100/AA	7/26/2011	601437	SECONDARY TEACHER	Certificated	T02	05	T	A			1.00	32,222

<u>Prog ID/Org</u>	<u>New Hire Effective Date</u>	<u>Position Number</u>	<u>Position Title</u>	<u>Exempt (Y/N)</u>	<u>SR Level</u>	<u>BU Code</u>	<u>T/P</u>	<u>MOF</u>	<u>Budgeted FTE</u>	<u>Budgeted Salary</u>	<u>Actual FTE</u>	<u>Actual Salary</u>
EDN100/AA	7/26/2011	65321	SECONDARY TEACHER	Certificated	T03	05	P	A	1.00	43,157	1.00	45,909
EDN100/AA	7/26/2011	602332	ELEM TEACHER	Certificated	T02	05	T	A			1.00	42,509
EDN100/AA	7/26/2011	66651	SECONDARY TEACHER	Certificated	T02	05	P	A	1.00	61,860	1.00	43,157
EDN100/AA	7/26/2011	67989	SECONDARY TEACHER	Certificated	T03	05	P	A	1.00	55,622	1.00	45,909
EDN150/FA	7/26/2011	75779	GEN EDUC/ARTICLE VI TCHR	Certificated	T02	05	T	A	1.00	54,778	1.00	42,509
EDN100/AA	7/26/2011	602259	ELEM TEACHER	Certificated	T02	05	T	A			1.00	42,509
EDN100/AA	7/26/2011	600183	ELEM TEACHER	Certificated	T02	05	T	A			1.00	42,509
EDN100/AA	7/26/2011	60367	SECONDARY TEACHER	Certificated	T02	05	P	A	1.00	56,132	1.00	32,222
EDN100/AA	7/26/2011	60808	ELEM TEACHER	Certificated	T02	05	P	A	1.00	56,132	1.00	42,509
EDN100/AA	7/26/2011	75808	ELEM TEACHER	Certificated	T02	05	T	A			1.00	42,509
EDN100/AA	7/26/2011	601930	ELEM TEACHER	Certificated	T02	05	T	A			1.00	43,157
EDN100/AA	7/26/2011	71505	ELEM TEACHER	Certificated	T02	05	P	A	1.00	59,737	1.00	42,509
EDN100/AA	7/26/2011	69748	ELEM TEACHER	Certificated	T02	05	P	A	1.00	63,898	1.00	42,509
EDN100/AA	7/26/2011	68231	SECONDARY TEACHER	Certificated	T02	05	P	A	1.00	75,983	1.00	42,509
EDN150/FA	7/26/2011	75159	GEN EDUC/ARTICLE VI TCHR	Certificated	T02	05	P	A	1.00	49,448	1.00	42,509
EDN150/FA	7/26/2011	63878	SPEC ED TEACHER	Certificated	T02	05	P	A	1.00	51,426	1.00	43,157
EDN100/AA	7/26/2011	63792	ELEM TEACHER	Certificated	T02	05	P	A	1.00	49,303	1.00	42,509
EDN100/AA	7/26/2011	63736	ELEM TEACHER	Certificated	T02	05	T	A	1.00	64,482	1.00	42,509
EDN100/BJ	7/26/2011	73102	SECONDARY TEACHER	Certificated	T02	05	T	A			1.00	42,509
EDN150/FA	7/26/2011	601457	GEN EDUC/ARTICLE VI TCHR	Certificated	T02	05	T	A			1.00	42,509
EDN100/AA	7/26/2011	73701	SECONDARY TEACHER	Certificated	T02	05	P	A	1.00	58,959	1.00	43,157
EDN150/FA	7/26/2011	602020	SPEC ED TEACHER	Certificated	T02	05	T	A			1.00	42,509
EDN150/FA	7/26/2011	71353	SPEC ED TEACHER	Certificated	T02	05	P	A	1.00	46,830	1.00	42,509
EDN100/DB	7/26/2011	63131	SECONDARY TEACHER	Certificated	T02	05	T	N			0.50	16,111
EDN100/AA	7/26/2011	68614	SECONDARY TEACHER	Certificated	T02	05	P	A	1.00	60,004	1.00	42,509
EDN100/AA	7/26/2011	64787	SECONDARY TEACHER	Certificated	T03	05	P	A	1.00	43,157	1.00	45,909
EDN100/AA	7/26/2011	601387	ELEM TEACHER	Certificated	T02	05	T	A			1.00	42,509
EDN100/AA	7/26/2011	62931	ELEM TEACHER	Certificated	T03	05	P	A	1.00	52,968	1.00	45,909
EDN100/AA	7/26/2011	60539	COUNSELOR	Certificated	T03	05	P	A	1.00	55,622	1.00	45,909
EDN100/AA	7/26/2011	67123	SECONDARY TEACHER	Certificated	T03	05	P	A	1.00	49,448	1.00	45,909
EDN100/AA	7/26/2011	63827	SECONDARY TEACHER	Certificated	T02	05	T	A	1.00	45,785	1.00	42,509
EDN100/AA	7/26/2011	67655	ELEM TEACHER	Certificated	T02	05	P	A	1.00	66,359	1.00	42,509
EDN100/AA	7/26/2011	69383	SECONDARY TEACHER	Certificated	T02	05	P	A	1.00	55,622	1.00	42,509
EDN100/AA	7/26/2011	602438	SECONDARY TEACHER	Certificated	T02	05	T	A			1.00	42,509
EDN100/AA	7/26/2011	66864	SECONDARY TEACHER	Certificated	T02	05	P	A	1.00	46,609	1.00	42,509
EDN100/AA	7/26/2011	602258	SPEC ED TEACHER	Certificated	T02	05	T	A			1.00	42,509
EDN150/FA	7/26/2011	61906	SPEC ED TEACHER	Certificated	T03	05	P	A	1.00	52,968	1.00	45,909
EDN100/AA	7/26/2011	71874	ELEM TEACHER	Certificated	T02	05	T	A	1.00	49,303	1.00	42,509
EDN150/FA	7/26/2011	74641	SPEC ED TEACHER	Certificated	T02	05	P	A	1.00	67,750	1.00	43,157
EDN100/AA	7/26/2011	75912	ELEM TEACHER	Certificated	T02	05	T	A	1.00	43,157	1.00	42,509
EDN100/AA	7/26/2011	62777	ELEM TEACHER	Certificated	T03	05	P	A	1.00	80,215	1.00	45,909
EDN100/AA	7/26/2011	602120	ELEM TEACHER	Certificated	T02	05	T	A			1.00	42,509
EDN150/FA	7/26/2011	69138	GEN EDUC/ARTICLE VI TCHR	Certificated	T03	05	P	A	1.00	46,609	1.00	47,287
EDN150/FA	7/26/2011	601837	SPEC ED TEACHER	Certificated	T02	05	T	A			1.00	42,509
EDN150/FA	7/26/2011	63733	SPEC ED TEACHER	Certificated	T02	05	T	A	1.00	46,609	1.00	32,222
EDN150/FA	7/26/2011	75890	GEN EDUC/ARTICLE VI TCHR	Certificated	T02	05	P	A	1.00	58,959	1.00	42,509
EDN150/FA	7/26/2011	61349	SPEC ED TEACHER	Certificated	T03	05	P	A	1.00	49,448	1.00	45,909

Department of Education
New Hires

Table 16

<u>Prog ID/Org</u>	<u>New Hire Effective Date</u>	<u>Position Number</u>	<u>Position Title</u>	<u>Exempt (Y/N)</u>	<u>SR Level</u>	<u>BU Code</u>	<u>T/P</u>	<u>MOF</u>	<u>Budgeted FTE</u>	<u>Budgeted Salary</u>	<u>Actual FTE</u>	<u>Actual Salary</u>
EDN150/FA	7/26/2011	74572	SPEC ED TEACHER	Certificated	T03	05	P	A	1.00	48,008	1.00	47,287
EDN100/AA	7/26/2011	67203	ELEM TEACHER	Certificated	T03	05	P	A	1.00	47,080	1.00	45,909
EDN100/AA	7/26/2011	64067	SECONDARY TEACHER	Certificated	T02	05	P	A	1.00	45,785	1.00	42,509
EDN100/AA	7/26/2011	601892	SPEC ED TEACHER	Certificated	T02	05	T	A			1.00	42,509
EDN150/FA	7/26/2011	75921	GEN EDUC/ARTICLE VI TCHR	Certificated	T02	05	P	A	1.00	40,567	1.00	42,509
EDN150/FA	7/26/2011	64291	GEN EDUC/ARTICLE VI TCHR	Certificated	T02	05	P	A			1.00	42,509
EDN100/AA	7/26/2011	73972	ELEM TEACHER	Certificated	T03	05	T	A	1.00	46,609	1.00	47,287
EDN150/FA	7/26/2011	73028	SPEC ED TEACHER	Certificated	T02	05	P	A	1.00	45,785	1.00	32,222
EDN100/AA	7/26/2011	63837	SECONDARY TEACHER	Certificated	T03	05	P	A	1.00	56,740	1.00	47,287
EDN100/AA	7/26/2011	61795	SECONDARY TEACHER	Certificated	T03	05	P	A	1.00	49,053	1.00	45,909
EDN100/AA	7/26/2011	68981	SECONDARY TEACHER	Certificated	T02	05	P	A	1.00	48,008	1.00	42,509
EDN150/FA	7/26/2011	73918	SPEC ED TEACHER	Certificated	T02	05	P	A	1.00	32,713	1.00	42,509
EDN100/DB	7/26/2011	79908	SECONDARY TEACHER	Certificated	T02	05	T	N			1.00	39,958
EDN100/AA	7/26/2011	602333	ELEM TEACHER	Certificated	T02	05	T	A			1.00	42,509
EDN150/FA	7/26/2011	600159	SPEC ED TEACHER	Certificated	T03	05	T	A			1.00	45,909
EDN100/AA	7/26/2011	69389	SECONDARY TEACHER	Certificated	T03	05	T	A	1.00	46,609	1.00	45,909
EDN150/FA	7/26/2011	75863	SPEC ED TEACHER	Certificated	T02	05	P	A	1.00	50,493	1.00	42,509
EDN150/FB	7/26/2011	60283	SPECIAL SCH TEACHER	Certificated	T03	05	P	A	1.00	43,157	1.00	45,909
EDN100/AA	7/26/2011	602359	ELEM TEACHER	Certificated	T03	05	T	A			1.00	45,909
EDN100/AA	7/26/2011	68611	ELEM TEACHER	Certificated	T03	05	P	A	1.00	74,688	1.00	45,909
EDN150/FA	7/26/2011	68270	SPEC ED TEACHER	Certificated	T02	05	P	A	1.00	45,497	1.00	42,509
EDN100/AA	7/26/2011	602241	ELEM TEACHER	Certificated	T03	05	T	A			1.00	47,287
EDN100/DB	7/26/2011	79225	ELEM TEACHER	Certificated	T02	05	T	N			1.00	42,509
EDN100/AA	7/26/2011	601167	SECONDARY TEACHER	Certificated	T03	05	T	A			1.00	45,909
EDN150/FA	7/26/2011	65121	SPEC ED TEACHER	Certificated	T02	05	P	A	1.00	45,785	1.00	43,785
EDN100/AA	7/26/2011	64392	ELEM TEACHER	Certificated	T02	05	P	A	1.00	44,202	1.00	42,509
EDN150/FA	7/26/2011	63116	SPEC ED TEACHER	Certificated	T02	05	P	A	1.00	46,609	1.00	32,222
EDN100/AA	7/26/2011	66842	SECONDARY TEACHER	Certificated	T02	05	T	A	1.00	40,567	1.00	32,222
EDN150/FA	7/26/2011	73335	SPEC ED TEACHER	Certificated	T03	05	P	A	1.00	43,157	1.00	45,909
EDN100/AA	7/26/2011	73709	COUNSELOR	Certificated	T03	05	P	A	1.00	60,729	1.00	45,909
EDN100/AA	7/26/2011	61771	ELEM TEACHER	Certificated	T02	05	T	A	1.00	43,157	1.00	42,509
EDN150/FA	7/26/2011	72728	SPEC ED TEACHER	Certificated	T02	05	P	A	1.00	46,609	1.00	42,509
EDN100/AA	7/26/2011	73779	SECONDARY TEACHER	Certificated	T02	05	P	A	1.00	79,170	1.00	42,509
EDN100/AA	7/26/2011	64528	SECONDARY TEACHER	Certificated	T02	05	P	A	1.00	43,157	1.00	42,509
EDN100/AA	7/26/2011	69928	ELEM TEACHER	Certificated	T03	05	P	A	1.00	47,080	1.00	45,909
EDN100/AA	7/26/2011	69158	ELEM TEACHER	Certificated	T03	05	P	A	1.00	50,743	1.00	45,909
EDN100/AA	7/26/2011	61340	SECONDARY TEACHER	Certificated	T02	05	P	A	1.00	63,959	1.00	42,509
EDN100/AA	7/26/2011	600822	ELEM TEACHER	Certificated	T02	05	T	A			1.00	42,509
EDN150/FA	7/26/2011	73550	GEN EDUC/ARTICLE VI TCHR	Certificated	T02	05	T	A	1.00	47,159	1.00	42,509
EDN100/AA	7/26/2011	601378	SECONDARY TEACHER	Certificated	T02	05	T	A			1.00	42,509
EDN100/AA	7/26/2011	73741	SECONDARY TEACHER	Certificated	T03	05	P	A	1.00	32,713	1.00	46,609
EDN100/AA	7/26/2011	74485	SECONDARY TEACHER	Certificated	T02	05	T	A	1.00	40,567	1.00	42,509
EDN150/FA	7/26/2011	601042	SPEC ED TEACHER	Certificated	T02	05	P	A			1.00	42,509
EDN100/AA	7/26/2011	600866	ELEM TEACHER	Certificated	T02	05	T	A			1.00	32,222
EDN150/FA	7/26/2011	71161	SPEC ED TEACHER	Certificated	T02	05	P	A	1.00	49,448	1.00	42,509
EDN150/FA	7/26/2011	71864	SPEC ED TEACHER	Certificated	T02	05	P	A	1.00	57,291	1.00	42,509
EDN100/AA	7/26/2011	66047	SECONDARY TEACHER	Certificated	T02	05	P	A	1.00	61,667	1.00	42,509

<u>Prog ID/Org</u>	<u>New Hire Effective Date</u>	<u>Position Number</u>	<u>Position Title</u>	<u>Exempt (Y/N)</u>	<u>SR Level</u>	<u>BU Code</u>	<u>T/P</u>	<u>MOF</u>	<u>Budgeted FTE</u>	<u>Budgeted Salary</u>	<u>Actual FTE</u>	<u>Actual Salary</u>
EDN150/FA	7/26/2011	69791	SPEC ED TEACHER	Certificated	T02	05	P	A	1.00	50,743	1.00	42,509
EDN100/AA	7/26/2011	75010	COUNSELOR/HIGH RISK	Certificated	T03	05	P	A	1.00	55,622	1.00	45,909
EDN150/FA	7/26/2011	75751	SPEC ED TEACHER	Certificated	T02	05	T	A	1.00	43,157	1.00	42,509
EDN150/FA	7/26/2011	73369	SPEC ED TEACHER	Certificated	T02	05	P	A	1.00	48,008	1.00	42,509
EDN150/FA	7/26/2011	73736	SPEC ED TEACHER	Certificated	T02	05	P	A	1.00	46,609	1.00	42,509
EDN100/AA	7/26/2011	65061	SECONDARY TEACHER	Certificated	T02	05	T	A	1.00	43,157	1.00	42,509
EDN150/FA	7/26/2011	65279	GEN EDUC/ARTICLE VI TCHR	Certificated	T03	05	P	A	1.00	45,785	1.00	47,287
EDN150/FA	7/26/2011	71670	SPEC ED TEACHER	Certificated	T03	05	T	A	1.00	43,157	1.00	45,909
EDN150/FA	7/26/2011	72129	SPEC ED TEACHER	Certificated	T03	05	P	A	1.00	49,448	1.00	48,008
EDN100/AA	7/26/2011	600088	ELEM TEACHER	Certificated	T02	05	T	A			1.00	42,509
EDN100/AA	7/26/2011	600077	SECONDARY TEACHER	Certificated	T02	05	T	A			1.00	43,785
EDN150/FA	7/26/2011	63521	SPEC ED TEACHER	Certificated	T02	05	P	A	1.00	32,713	1.00	42,509
EDN150/FA	7/26/2011	76329	SPEC ED TCHR/PRE-SCHOOL	Certificated	T02	05	P	A	1.00	44,452	1.00	42,509
EDN150/FA	7/26/2011	62115	SPEC ED TEACHER	Certificated	T02	05	P	A			1.00	42,509
EDN150/FA	7/26/2011	73225	SPEC ED TEACHER	Certificated	T02	05	P	A	1.00	46,609	1.00	42,509
EDN100/AA	7/26/2011	64569	SECONDARY TEACHER	Certificated	T02	05	P	A	1.00	46,609	1.00	42,509
EDN150/FA	7/26/2011	75504	SPEC ED TEACHER	Certificated	T03	05	T	A	1.00	53,483	1.00	45,909
EDN100/AA	7/26/2011	602928	ELEM TEACHER	Certificated	T03	05	T	A			1.00	45,909
EDN150/FA	7/26/2011	68398	SPEC ED TEACHER	Certificated	T02	05	P	A	1.00	44,452	1.00	42,509
EDN150/FA	7/26/2011	74181	SPEC ED TEACHER	Certificated	T02	05	P	A	1.00	46,609	1.00	42,509
EDN150/FA	7/26/2011	68191	GEN EDUC/ARTICLE VI TCHR	Certificated	T02	05	P	A	1.00	51,426	1.00	42,509
EDN150/FA	7/26/2011	76330	SPEC ED TEACHER	Certificated	T02	05	P	A	1.00	43,157	1.00	42,509
EDN150/FA	7/26/2011	73248	SPEC ED TEACHER	Certificated	T02	05	P	A	1.00	49,448	1.00	42,509
EDN150/FA	7/26/2011	68681	SPEC ED TEACHER	Certificated	T02	05	T	A	1.00	40,567	1.00	42,509
EDN150/FA	7/26/2011	74182	SPEC ED TEACHER	Certificated	T02	05	P	A	1.00	49,448	1.00	42,509
EDN100/AA	7/26/2011	64161	ELEM TEACHER	Certificated	T02	05	P	A	1.00	44,452	1.00	42,509
EDN150/FA	7/26/2011	72337	SPEC ED TEACHER	Certificated	T02	05	P	A	1.00	50,493	1.00	42,509
EDN150/FA	7/26/2011	73891	SPEC ED TCHR/PRE-SCHOOL	Certificated	T02	05	P	A	1.00	46,609	1.00	42,509
EDN150/FA	7/26/2011	68896	SPEC ED TEACHER	Certificated	T02	05	P	A	1.00	60,779	1.00	32,222
EDN150/FB	7/26/2011	60267	SPECIAL SCH TEACHER	Certificated	T03	05	P	A	1.00	35,329	1.00	47,287
EDN100/AA	7/26/2011	602339	ELEM TEACHER	Certificated	T02	05	T	A			1.00	42,509
EDN100/AA	7/26/2011	600736	SECONDARY TEACHER	Certificated	T02	05	T	A			1.00	32,222
EDN100/AA	7/26/2011	71165	SECONDARY TEACHER	Certificated	T02	05	T	A	0.50	29,341	1.00	42,509
EDN150/FA	7/26/2011	65971	SPEC ED TEACHER	Certificated	T02	05	P	A	1.00	48,008	1.00	42,509
EDN100/AA	7/26/2011	65788	SECONDARY TEACHER	Certificated	T02	05	P	A	1.00	53,483	1.00	42,509
EDN100/AA	7/26/2011	64465	SECONDARY TEACHER	Certificated	T03	05	T	A	1.00	54,558	1.00	45,909
EDN150/SA	7/26/2011	56275	SPEECH PATHOLOGIST IV	Y	SR22	13	P	A	1.00	58,563	1.00	45,576
EDN100/AA	7/26/2011	601355	ELEM TEACHER	Certificated	T02	05	T	A			1.00	42,509
EDN100/DB	7/26/2011	600101	ELEM TEACHER	Certificated	T02	05	T	N			1.00	42,509
EDN100/AA	7/26/2011	66819	SECONDARY TEACHER	Certificated	T02	05	P	A	1.00	55,622	1.00	42,509
EDN100/AA	7/26/2011	602358	ELEM TEACHER	Certificated	T02	05	T	A			1.00	42,509
EDN100/AA	7/26/2011	66004	ELEM TEACHER	Certificated	T02	05	P	A	1.00	58,959	1.00	43,785
EDN100/AA	7/26/2011	72363	SECONDARY TEACHER	Certificated	T03	05	P	A	1.00	68,351	1.00	45,909
EDN100/AA	7/26/2011	67561	SECONDARY TEACHER	Certificated	T03	05	P	A	1.00	68,351	1.00	45,909
EDN100/AA	7/26/2011	61310	ELEM TEACHER	Certificated	T02	05	P	A	1.00	46,830	1.00	42,509
EDN100/AA	7/26/2011	602309	SECONDARY TEACHER	Certificated	T03	05	T	A			1.00	45,909
EDN150/SA	7/26/2011	46976	SOCIAL WORKER IV	N	SR22	13	P	A	1.00	64,105	1.00	45,576

Department of Education
New Hires

Table 16

<u>Prog ID/Org</u>	<u>New Hire Effective Date</u>	<u>Position Number</u>	<u>Position Title</u>	<u>Exempt (Y/N)</u>	<u>SR Level</u>	<u>BU Code</u>	<u>T/P</u>	<u>MOF</u>	<u>Budgeted FTE</u>	<u>Budgeted Salary</u>	<u>Actual FTE</u>	<u>Actual Salary</u>
EDN100/AA	7/26/2011	802235	SCHOOL CUSTODIAN II	N	BC02	01	T	A			1.00	17,258
EDN100/AA	7/26/2011	71955	SECONDARY TEACHER	Certificated	T02	05	P	A	1.00	43,157	1.00	39,958
EDN150/FA	7/26/2011	73809	SPEC ED TEACHER	Certificated	T02	05	P	A	1.00	52,721	1.00	39,958
EDN100/AA	7/26/2011	68703	SECONDARY TEACHER	Certificated	T02	05	T	A	1.00	40,567	1.00	42,509
EDN100/AA	7/26/2011	66632	SECONDARY TEACHER	Certificated	T02	05	P	A	1.00	46,609	1.00	39,958
EDN150/FA	7/26/2011	73942	SPEC ED TEACHER	Certificated	T02	05	P	A			1.00	39,958
EDN150/FA	7/26/2011	72433	SPEC ED TEACHER	Certificated	T02	05	P	A	1.00	48,008	1.00	39,958
EDN150/FA	7/26/2011	75686	SPEC ED TEACHER	Certificated	T02	05	T	A	1.00	48,008	1.00	39,958
EDN150/FA	7/26/2011	75567	GEN EDUC/ARTICLE VI TCHR	Certificated	T02	05	T	A	1.00	43,157	1.00	42,509
EDN100/AA	7/26/2011	68675	SECONDARY TEACHER	Certificated	T02	05	T	A	1.00	48,008	1.00	39,958
EDN150/FA	7/26/2011	75928	GEN EDUC/ARTICLE VI TCHR	Certificated	T02	05	P	A	1.00	48,008	1.00	39,958
EDN100/AA	7/26/2011	63773	SECONDARY TEACHER	Certificated	T02	05	P	A	1.00	32,713	1.00	42,509
EDN100/AA	7/26/2011	65172	ELEM TEACHER	Certificated	T02	05	P	A	1.00	66,416	1.00	39,958
EDN150/FA	7/26/2011	64639	SPEC ED TCHR/PRE-SCHOOL	Certificated	T02	05	P	A	1.00	51,426	1.00	42,509
EDN150/FA	7/26/2011	600535	SPEC ED TEACHER	Certificated	T02	05	T	A			1.00	39,958
EDN150/FA	7/26/2011	74084	SPEC ED TEACHER	Certificated	T02	05	T	A	1.00	40,567	1.00	39,958
EDN150/FA	7/26/2011	67250	SPEC ED TEACHER	Certificated	T02	05	T	A	1.00	43,157	1.00	39,958
EDN100/AA	7/26/2011	68630	SECONDARY TEACHER	Certificated	T02	05	P	A	1.00	40,567	1.00	39,958
EDN150/FA	7/26/2011	75929	GEN EDUC/ARTICLE VI TCHR	Certificated	T02	05	P	A	1.00	40,567	1.00	39,958
EDN150/FA	7/26/2011	73680	SPEC ED TEACHER	Certificated	T02	05	P	A	1.00	52,460	1.00	39,958
EDN100/AA	7/26/2011	600349	10-MO STUDENT SVCS COORD	Certificated	T02	05	T	A			1.00	39,958
EDN100/AA	7/26/2011	62101	SECONDARY TEACHER	Certificated	T02	05	T	A	1.00	43,157	1.00	39,958
EDN100/AA	7/26/2011	71892	SECONDARY TEACHER	Certificated	T02	05	P	A	1.00	32,713	1.00	39,958
EDN100/AA	7/26/2011	62313	SECONDARY TEACHER	Certificated	T02	05	P	A	1.00	64,482	1.00	39,958
EDN150/FA	7/26/2011	64281	SPEC ED TEACHER	Certificated	T02	05	P	A	1.00	32,713	1.00	39,958
EDN150/FA	7/26/2011	76028	SPEC ED TEACHER	Certificated	T02	05	T	A	1.00	50,785	1.00	39,958
EDN100/DB	7/26/2011	79665	SECONDARY TEACHER	Certificated	T02	05	T	N			1.00	39,958
EDN100/AA	7/26/2011	61930	SECONDARY TEACHER	Certificated	T02	05	P	A	1.00	40,567	1.00	39,958
EDN100/AA	7/26/2011	63122	ELEM TEACHER	Certificated	T03	05	P	A	1.00	52,471	1.00	43,154
EDN150/FA	7/26/2011	75647	SPEC ED TEACHER	Certificated	T02	05	T	A	1.00	51,426	1.00	39,958
EDN150/FA	7/26/2011	67998	SPEC ED TEACHER	Certificated	T02	05	P	A	1.00	48,008	1.00	39,958
EDN100/AA	7/26/2011	65060	ELEM TEACHER	Certificated	T02	05	P	A	1.00	54,033	1.00	39,958
EDN150/FA	7/26/2011	75945	GEN EDUC/ARTICLE VI TCHR	Certificated	T03	05	P	A	1.00	43,157	1.00	43,154
EDN150/FA	7/26/2011	72429	SPEC ED TEACHER	Certificated	T02	05	P	A	1.00	40,567	1.00	39,958
EDN150/FA	7/26/2011	75660	GEN EDUC/ARTICLE VI TCHR	Certificated	T02	05	T	A	1.00	46,609	1.00	39,958
EDN100/AA	7/26/2011	69226	SECONDARY TEACHER	Certificated	T02	05	T	A	1.00	56,917	1.00	39,958
EDN150/FA	7/26/2011	71866	SPEC ED TEACHER	Certificated	T02	05	P	A	1.00	45,785	1.00	39,958
EDN100/AA	7/26/2011	602252	ELEM TEACHER	Certificated	T03	05	T	A			1.00	43,154
EDN150/FA	7/26/2011	67385	SPEC ED TEACHER	Certificated	T02	05	P	A	1.00	51,426	1.00	39,958
EDN150/FA	7/26/2011	75656	SPEC ED TEACHER	Certificated	T02	05	T	A	1.00	32,713	1.00	39,958
EDN100/AA	7/26/2011	600730	SECONDARY TEACHER	Certificated	T02	05	T	A			1.00	39,958
EDN100/AA	7/26/2011	62852	SECONDARY TEACHER	Certificated	T02	05	P	A	1.00	74,688	1.00	39,958
EDN100/AA	7/26/2011	600604	SECONDARY TEACHER	Certificated	T02	05	T	A			1.00	39,958
EDN100/AA	7/26/2011	73197	SECONDARY TEACHER	Certificated	T02	05	T	A	1.00	72,513	1.00	39,958
EDN100/AA	7/26/2011	63777	SECONDARY TEACHER	Certificated	T02	05	P	A	1.00	45,785	1.00	39,958
EDN100/AA	7/26/2011	64876	ELEM TEACHER	Certificated	T02	05	P	A	1.00	56,740	1.00	39,958
EDN100/AA	7/26/2011	68331	SECONDARY TEACHER	Certificated	T02	05	P	A	1.00	57,291	1.00	39,958

Department of Education
New Hires

Table 16

<u>Prog ID/Org</u>	<u>New Hire Effective Date</u>	<u>Position Number</u>	<u>Position Title</u>	<u>Exempt (Y/N)</u>	<u>SR Level</u>	<u>BU Code</u>	<u>T/P</u>	<u>MOF</u>	<u>Budgeted FTE</u>	<u>Budgeted Salary</u>	<u>Actual FTE</u>	<u>Actual Salary</u>
EDN150/FA	7/26/2011	69946	SPEC ED TEACHER	Certificated	T02	05	P	A	1.00	44,452	1.00	39,958
EDN150/FA	7/26/2011	69052	SPEC ED TEACHER	Certificated	T02	05	P	A	1.00	51,426	1.00	39,958
EDN150/FA	7/26/2011	71802	SPEC ED TEACHER	Certificated	T02	05	P	A	1.00	56,740	1.00	42,509
EDN150/FA	7/26/2011	69083	SPEC ED TEACHER	Certificated	T01	05	P	A	1.00	40,567	1.00	29,662
EDN150/FA	7/26/2011	600146	GEN EDUC/ARTICLE VI TCHR	Certificated	T02	05	T	A			1.00	39,958
EDN100/AA	7/26/2011	68358	ELEM TEACHER	Certificated	T03	05	P	A	1.00	70,400	1.00	45,909
EDN100/AA	7/26/2011	68993	SECONDARY TEACHER	Certificated	T02	05	P	A	1.00	46,830	1.00	39,958
EDN100/DB	7/26/2011	79609	SECONDARY TEACHER	Certificated	T02	05	T	N			1.00	42,509
EDN100/AA	7/26/2011	29496	SCHOOL HEALTH AIDE	N	SR09	03	P	A	1.00	29,010	1.00	18,078
EDN150/FA	7/26/2011	601482	SPEC ED TEACHER	Certificated	T03	05	T	A			1.00	47,287
EDN100/AA	7/26/2011	67519	ELEM TEACHER	Certificated	T03	05	P	A	1.00	57,291	1.00	45,909
EDN100/AA	7/26/2011	72189	ELEM TEACHER	Certificated	T03	05	P	A	1.00	58,336	1.00	45,909
EDN100/AA	7/26/2011	65965	ELEM TEACHER	Certificated	T03	05	P	A	1.00	72,513	1.00	45,909
EDN100/AA	7/26/2011	69478	ELEM TEACHER	Certificated	T03	05	T	A	1.00	43,157	1.00	45,909
EDN100/AA	7/26/2011	63605	ELEM TEACHER	Certificated	T03	05	P	A	1.00	51,426	1.00	45,909
EDN100/AA	7/26/2011	66316	SECONDARY TEACHER	Certificated	T03	05	P	A	1.00	54,033	1.00	45,909
EDN100/AA	7/26/2011	602251	SECONDARY TEACHER	Certificated	T02	05	T	A			1.00	39,958
EDN100/AA	7/26/2011	61269	SECONDARY TEACHER	Certificated	T02	05	P	A	1.00	64,482	1.00	39,958
EDN100/AA	7/26/2011	65771	COUNSELOR	Certificated	T02	05	P	A	1.00	43,157	1.00	42,509
EDN100/AA	7/26/2011	74149	SECONDARY TEACHER	Certificated	T03	05	T	A	1.00	44,452	1.00	45,909
EDN100/AA	7/26/2011	602310	ELEM TEACHER	Certificated	T02	05	T	A			1.00	42,509
EDN100/AA	7/26/2011	600237	ELEM TEACHER	Certificated	T02	05	T	A			1.00	42,509
EDN150/FA	7/26/2011	75653	SPEC ED TEACHER	Certificated	T02	05	T	A	1.00	46,609	1.00	32,222
EDN100/AA	7/26/2011	601671	ELEM TEACHER	Certificated	T02	05	T	A			1.00	42,509
EDN150/FA	7/26/2011	73295	SPEC ED TEACHER	Certificated	T02	05	P	A	1.00	50,743	1.00	42,509
EDN150/SA	7/26/2011	30414	SPEECH PATHOLOGIST IV	Y	SR22	13	P	A	1.00	69,305	1.00	45,576
EDN150/FA	7/26/2011	75501	SPEC ED TEACHER	Certificated	T02	05	T	A	1.00	79,170	1.00	42,509
EDN150/FA	7/26/2011	602311	SPEC ED TEACHER	Certificated	T02	05	T	A			1.00	42,509
EDN150/FA	7/26/2011	601068	SPEC ED TEACHER	Certificated	T03	05	T	A			1.00	45,909
EDN200/GN	7/26/2011	1818	PRIVATE SECRETARY I	N	SR20	03	P	A	1.00	44,412	1.00	41,040
EDN150/FA	7/26/2011	62720	SPEC ED TEACHER	Certificated	T02	05	P	A	1.00	40,567	1.00	32,222
EDN150/FA	7/26/2011	64822	SPEC ED TEACHER	Certificated	T02	05	P	A	1.00	53,483	1.00	32,222
EDN100/AA	7/26/2011	602253	ELEM TEACHER	Certificated	T03	05	T	A			1.00	45,909
EDN150/SA	7/26/2011	56179	SPEECH PATHOLOGIST III	Y	SR20	13	P	A	1.00	56,247	1.00	42,132
EDN150/FA	7/26/2011	75457	GEN EDUC/ARTICLE VI TCHR	Certificated	T02	05	T	A	1.00	58,959	1.00	42,509
EDN150/SA	7/26/2011	56191	SPEECH PATHOLOGIST II	Y	SR18	13	P	A	1.00	56,247	1.00	37,044
EDN100/AA	7/26/2011	601434	SECONDARY TEACHER	Certificated	T03	05	T	A			1.00	47,287
EDN100/AA	7/26/2011	602294	SPEC ED TEACHER	Certificated	T02	05	T	A			1.00	43,785
EDN150/FA	7/27/2011	29655	EDUC ASST III	Y	SR12	03	P	A	1.00	31,769	1.00	25,030
EDN150/FA	7/27/2011	63074	SPEC ED TEACHER	Certificated	T02	05	P	A	1.00	43,157	1.00	42,509
EDN150/FA	7/27/2011	52556	EDUC ASST III	Y	SR12	03	P	A	1.00	26,131	1.00	25,030
EDN150/FA	7/27/2011	800606	EDUC ASST III	Y	SR12	03	T	A	1.00	27,154	1.00	25,030
EDN100/AA	7/27/2011	602383	ELEM TEACHER	Certificated	T02	05	T	A			1.00	42,509
EDN150/FA	7/27/2011	67549	SPEC ED TEACHER	Certificated	T02	05	P	A	1.00	48,008	1.00	42,509
EDN150/FA	7/27/2011	800044	EDUC ASST II	Y	SR10	03	T	A	0.75	19,599	0.75	17,348
EDN100/AA	7/27/2011	56504	CLERK II	N	SR06	03	P	A	1.00	25,668	1.00	12,301
EDN150/FA	7/27/2011	76075	SPEC ED TEACHER	Certificated	T03	05	P	A	1.00	49,448	1.00	45,909

Department of Education
New Hires

Table 16

<u>Prog ID/Org</u>	<u>New Hire Effective Date</u>	<u>Position Number</u>	<u>Position Title</u>	<u>Exempt (Y/N)</u>	<u>SR Level</u>	<u>BU Code</u>	<u>T/P</u>	<u>MOF</u>	<u>Budgeted FTE</u>	<u>Budgeted Salary</u>	<u>Actual FTE</u>	<u>Actual Salary</u>
EDN150/FA	7/27/2011	56715	EDUC ASST III	Y	SR12	03	T	A	1.00	26,131	1.00	25,030
EDN100/AA	7/27/2011	39108	EDUC ASST III	Y	SR12	03	P	A	0.50	13,066	0.50	12,515
EDN150/FA	7/27/2011	57597	EDUC ASST II	Y	SR10	03	T	A	0.63	16,332	0.63	14,456
EDN100/AA	7/27/2011	602382	ELEM TEACHER	Certificated	T02	05	T	A			1.00	42,509
EDN150/FA	7/27/2011	55429	EDUC ASST II	Y	SR10	03	P	A	0.50	13,066	0.50	11,565
EDN100/AA	7/27/2011	74472	SECONDARY TEACHER	Certificated	T03	05	P	A	1.00	51,426	1.00	45,909
EDN100/AA	7/27/2011	56002	CLERK III	N	SR08	03	P	A	1.00	30,036	1.00	25,668
EDN150/FA	7/27/2011	55437	EDUC ASST II	Y	SR10	03	P	A	0.75	19,599	0.75	17,348
EDN100/AA	7/27/2011	74847	ELEM TEACHER	Certificated	T02	05	T	A			1.00	42,509
EDN150/FA	7/27/2011	73187	SPEC ED TEACHER	Certificated	T02	05	P	A	1.00	61,774	1.00	42,509
EDN100/AA	7/27/2011	74400	ELEM TEACHER	Certificated	T02	05	T	A	1.00	51,426	1.00	42,509
EDN150/FA	7/27/2011	61817	SPEC ED TEACHER	Certificated	T02	05	P	A	1.00	43,157	1.00	42,509
EDN150/FA	7/27/2011	56771	EDUC ASST II	Y	SR10	03	T	A	0.75	22,026	0.75	17,348
EDN150/FA	7/27/2011	602044	SPEC ED TEACHER	Certificated	T03	05	T	A			1.00	45,909
EDN100/AA	7/27/2011	71399	COUNSELOR	Certificated	T03	05	T	A			1.00	45,909
EDN150/FA	7/27/2011	71865	SPEC ED TCHR/PRE-SCHOOL	Certificated	T03	05	P	A	1.00	51,426	1.00	45,909
EDN150/YG	7/27/2011	801859	EDUC ASST II	Y	SR10	03	T	A			1.00	23,130
EDN150/NB	7/27/2011	602355	SPEC ED TEACHER	Certificated	T02	05	T	N			1.00	32,222
EDN100/AA	7/27/2011	602381	ELEM TEACHER	Certificated	T02	05	T	A			1.00	42,509
EDN150/FA	7/27/2011	58007	EDUC ASST III	Y	SR12	03	T	A	0.75	20,366	0.75	18,773
EDN150/FA	7/27/2011	29640	EDUC ASST II	Y	SR10	03	P	A	0.50	15,885	0.50	11,565
EDN100/AA	7/27/2011	69349	ELEM TEACHER	Certificated	T02	05	T	A	1.00	46,609	1.00	42,509
EDN150/YG	7/27/2011	800473	EDUC ASST II	Y	SR10	03	P	A	1.00	26,131	1.00	23,130
EDN150/SA	7/27/2011	56364	SPEECH PATHOLOGIST IV	Y	SR22	13	P	A	1.00	58,563	1.00	45,576
EDN150/SA	7/27/2011	51213	COMMUNICATION AIDE	Y	SR12	03	P	A	0.50	13,577	0.50	12,515
EDN150/YG	7/27/2011	800881	EDUC ASST III	Y	SR12	03	P	A	1.00	26,131	1.00	25,030
EDN150/SA	7/28/2011	55683	SPEECH PATHOLOGIST II	Y	SR18	13	P	A	1.00	58,563	1.00	38,988
EDN150/YG	7/28/2011	801714	EDUC ASST III	Y	SR12	03	T	A			1.00	25,030
EDN100/AA	7/28/2011	62344	VICE PRINCIPAL III	Certificated	E05	06	P	A	1.00	94,393	1.00	69,097
EDN150/FA	7/29/2011	801131	EDUC ASST III	Y	SR12	03	T	A	1.00	26,131	1.00	25,030
EDN400/MD	7/29/2011	52940	CAFETERIA HELPER	N	BC02	01	T	N	0.50	16,614	0.50	16,614
EDN100/AA	7/29/2011	56456	CLERK TYPIST II	N	SR08	03	P	A	0.50	12,834	0.50	12,834
EDN400/MD	7/29/2011	59622	CAFETERIA HELPER	N	BC02	01	T	A			0.50	16,614
EDN400/MD	7/29/2011	49660	CAFETERIA HELPER	N	BC02	01	T	N	0.50	16,614	0.50	16,614
EDN100/AA	7/29/2011	801371	SCHOOL SECURITY ATTENDANT	N	SR07	03	T	A	1.00	21,444	1.00	20,540
EDN400/MD	7/29/2011	14660	CAFETERIA HELPER	N	BC02	01	T	N			0.50	16,614
EDN150/FA	7/29/2011	601886	SPEC ED TEACHER	Certificated	T02	05	T	A			1.00	42,509
EDN400/MD	7/29/2011	801812	CAFETERIA HELPER	N	BC02	01	T	N			0.50	16,614
EDN100/AA	7/29/2011	16197	SCHOOL CUSTODIAN II	N	BC02	01	P	A	0.50	16,614	0.50	16,614
EDN100/BX	7/31/2011	73011	TEACHER/DORMITORY	Certificated	T02	05	P	A	1.00	45,785	1.00	32,222
EDN100/AA	8/1/2011	31268	SCHOOL CUSTODIAN II	N	BC02	01	P	A	0.50	16,614	0.50	8,629
EDN150/FA	8/1/2011	65043	GEN EDUC/ARTICLE VI TCHR	Certificated	T02	05	P	A			1.00	42,509
EDN100/DB	8/1/2011	800129	EDUC ASST I	Y	SR08	03	T	N			1.00	13,327
EDN400/MB	8/1/2011	800731	PRGM SPCLT VI	N	SR26	13	T	N	1.00	55,500	1.00	55,500
EDN100/AA	8/1/2011	602240	ELEM TEACHER	Certificated	T02	05	T	A			1.00	42,509
EDN100/AA	8/1/2011	600809	ELEM TEACHER	Certificated	T02	05	T	A			1.00	42,509
EDN100/AA	8/1/2011	65092	ELEM TEACHER	Certificated	T03	05	P	A	1.00	50,493	1.00	45,909

<u>Prog ID/Org</u>	<u>New Hire Effective Date</u>	<u>Position Number</u>	<u>Position Title</u>	<u>Exempt (Y/N)</u>	<u>SR Level</u>	<u>BU Code</u>	<u>T/P</u>	<u>MOF</u>	<u>Budgeted FTE</u>	<u>Budgeted Salary</u>	<u>Actual FTE</u>	<u>Actual Salary</u>
EDN150/FA	8/1/2011	602329	SPEC ED TEACHER	Certificated	T02	05	T	A			1.00	42,509
EDN150/FA	8/1/2011	74159	SPEC ED TEACHER	Certificated	T02	05	P	A	1.00	55,622	1.00	42,509
EDN400/MD	8/1/2011	52984	CAFETERIA HELPER	N	BC02	01	T	N			0.50	16,614
EDN400/MD	8/1/2011	54896	CAFETERIA HELPER	N	BC02	01	T	N			0.50	16,614
EDN400/MD	8/1/2011	54591	CAFETERIA HELPER	N	BC02	01	P	A			0.50	16,614
EDN100/AA	8/1/2011	801950	EDUC ASST III	Y	SR12	03	T	A			1.00	25,030
EDN100/AA	8/1/2011	69471	ELEM TEACHER	Certificated	T03	05	P	A	1.00	43,157	1.00	45,909
EDN100/AA	8/1/2011	71503	SECONDARY TEACHER	Certificated	T02	05	T	A	1.00	36,463	1.00	42,509
EDN100/AA	8/1/2011	30662	SCHOOL SECURITY ATTENDANT	N	SR07	03	P	A	1.00	28,209	1.00	20,540
EDN100/AA	8/1/2011	800779	SCHOOL CUSTODIAN II	N	BC02	01	T	A	0.50	16,614	0.50	16,614
EDN100/AA	8/1/2011	62471	SECONDARY TEACHER	Certificated	T02	05	P	A	1.00	46,830	1.00	32,222
EDN150/FA	8/1/2011	65101	SPEC ED TEACHER	Certificated	T02	05	P	A	1.00	45,785	1.00	42,509
EDN100/AA	8/1/2011	61261	SECONDARY TEACHER	Certificated	T02	05	P	A	1.00	32,713	1.00	42,509
EDN150/FA	8/1/2011	57128	EDUC ASST II	Y	SR10	03	T	A			1.00	23,130
EDN100/AA	8/1/2011	66710	ELEM TEACHER	Certificated	T02	05	P	A	1.00	50,743	1.00	42,509
EDN100/AA	8/1/2011	56656	CLERK TYPIST II	N	SR08	03	P	A	1.00	28,836	1.00	25,668
EDN100/AA	8/1/2011	61533	ELEM TEACHER	Certificated	T03	05	P	A	1.00	64,427	1.00	45,909
EDN100/AA	8/1/2011	602323	ELEM TEACHER	Certificated	T02	05	T	A			1.00	42,509
EDN100/AA	8/1/2011	602254	SPEC ED TEACHER	Certificated	T02	05	T	A			1.00	42,509
EDN150/FA	8/1/2011	60342	SPEC ED TEACHER	Certificated	T03	05	P	A	1.00	44,452	1.00	45,909
EDN100/AA	8/1/2011	602255	SPEC ED TEACHER	Certificated	T02	05	T	A			1.00	42,509
EDN100/AA	8/1/2011	64240	SECONDARY TEACHER	Certificated	T02	05	P	A	1.00	48,008	1.00	42,509
EDN150/FA	8/1/2011	601726	SPEC ED TEACHER	Certificated	T02	05	T	A			1.00	42,509
EDN150/FA	8/1/2011	66274	SPEC ED TEACHER	Certificated	T02	05	P	A	1.00	33,694	1.00	42,509
EDN100/BV	8/1/2011	601558	ELEM TEACHER	Certificated	T03	05	P	A			1.00	47,287
EDN100/AA	8/1/2011	44137	SCHOOL CUSTODIAN II	N	BC02	01	P	A	1.00	33,228	1.00	33,228
EDN150/FA	8/1/2011	75583	GEN EDUC/ARTICLE VI TCHR	Certificated	T02	05	T	A			1.00	32,222
EDN100/AA	8/1/2011	56610	CLERK TYPIST II	N	SR08	03	P	A	1.00	28,836	1.00	25,668
EDN100/BJ	8/1/2011	801647	SCHOOL SECURITY ATTENDANT	N	SR07	03	T	A			0.75	9,599
EDN150/FA	8/1/2011	600823	GEN EDUC/ARTICLE VI TCHR	Certificated	T02	05	T	A			1.00	42,509
EDN150/FA	8/2/2011	62510	SPEC ED TEACHER	Certificated	T02	05	P	A	1.00	64,482	1.00	32,222
EDN150/FA	8/2/2011	63846	GEN EDUC/ARTICLE VI TCHR	Certificated	T02	05	P	A			1.00	42,509
EDN100/AA	8/2/2011	61706	SECONDARY TEACHER	Certificated	T03	05	P	A	1.00	67,750	1.00	45,909
EDN150/FA	8/2/2011	72377	SPEC ED TEACHER	Certificated	T03	05	P	A	1.00	49,448	1.00	45,909
EDN100/AA	8/2/2011	71897	ELEM TEACHER	Certificated	T02	05	P	A	1.00	45,785	1.00	42,509
EDN150/FA	8/2/2011	65480	SPEC ED TEACHER	Certificated	T03	05	P	A	1.00	71,695	1.00	45,909
EDN100/AA	8/2/2011	64778	SECONDARY TEACHER	Certificated	T02	05	P	A	1.00	50,412	1.00	32,222
EDN100/AA	8/3/2011	802253	DP USER SUPPORT TECH II	N	SR15	03	T	A			1.00	17,528
EDN150/FA	8/3/2011	602347	GEN EDUC/ARTICLE VI TCHR	Certificated	T02	05	T	A			1.00	42,509
EDN100/AA	8/3/2011	30606	SCHOOL SECURITY ATTENDANT	N	SR07	03	P	A	1.00	30,506	1.00	20,540
EDN100/AA	8/3/2011	802200	DP USER SUPPORT TECH II	N	SR15	03	T	A			1.00	17,528
EDN100/AA	8/4/2011	61684	SECONDARY TEACHER	Certificated	T02	05	P	A	1.00	79,170	1.00	32,222
EDN150/YG	8/4/2011	801737	EDUC ASST II	Y	SR10	03	T	A			1.00	23,130
EDN100/AA	8/5/2011	600294	ELEM TEACHER	Certificated	T02	05	T	A			1.00	42,509
EDN100/AA	8/5/2011	68936	SECONDARY TEACHER	Certificated	T03	05	P	A	1.00	62,024	1.00	45,909
EDN100/DB	8/5/2011	800127	EDUC ASST I	Y	SR08	03	T	N			1.00	13,327
EDN150/YG	8/5/2011	801525	EDUC ASST III	Y	SR12	03	T	A			1.00	25,030

<u>Prog ID/Org</u>	<u>New Hire Effective Date</u>	<u>Position Number</u>	<u>Position Title</u>	<u>Exempt (Y/N)</u>	<u>SR Level</u>	<u>BU Code</u>	<u>T/P</u>	<u>MOF</u>	<u>Budgeted FTE</u>	<u>Budgeted Salary</u>	<u>Actual FTE</u>	<u>Actual Salary</u>
EDN150/FA	8/8/2011	72339	SPEC ED TEACHER	Certificated	T02	05	P	A	1.00	49,448	1.00	42,509
EDN100/AA	8/8/2011	602386	ELEM TEACHER	Certificated	T02	05	T	A			1.00	42,509
EDN100/DB	8/8/2011	800128	EDUC ASST I	Y	SR08	03	T	N			1.00	13,327
EDN150/SA	8/8/2011	37409	SPEECH PATHOLOGIST II	Y	SR18	13	P	A	1.00	56,247	1.00	20,239
EDN150/FA	8/8/2011	602346	GEN EDUC/ARTICLE VI TCHR	Certificated	T02	05	T	A			1.00	42,509
EDN100/AA	8/8/2011	60241	COUNSELOR	Certificated	T03	05	P	A	1.00	53,483	1.00	45,909
EDN100/AA	8/8/2011	67312	ELEM TEACHER	Certificated	T02	05	P	A	1.00	79,170	1.00	42,509
EDN150/FA	8/8/2011	71674	GEN EDUC/ARTICLE VI TCHR	Certificated	T03	05	P	A			1.00	45,909
EDN150/FA	8/8/2011	67672	SPEC ED TEACHER	Certificated	T03	05	P	A	1.00	53,483	1.00	45,909
EDN150/FA	8/8/2011	601028	GEN EDUC/ARTICLE VI TCHR	Certificated	T03	05	T	A			1.00	45,909
EDN150/YG	8/8/2011	801878	EDUC ASST III	Y	SR12	03	T	A			1.00	25,030
EDN150/SA	8/8/2011	56180	SPEECH PATHOLOGIST IV	Y	SR22	13	P	A	1.00	63,644	1.00	45,576
EDN150/YG	8/9/2011	801871	EDUC ASST III	Y	SR12	03	T	A			1.00	25,030
EDN100/AA	8/9/2011	19062	ACCOUNT CLERK IV	N	SR13	03	P	A	1.00	31,212	1.00	16,211
EDN100/AA	8/9/2011	75157	ELEM TEACHER	Certificated	T03	05	T	A	1.00	50,743	1.00	47,287
EDN100/AA	8/9/2011	602389	ELEM TEACHER	Certificated	T03	05	T	A			1.00	45,909
EDN100/AA	8/10/2011	71769	ELEM TEACHER	Certificated	T02	05	P	A	1.00	46,609	1.00	42,509
EDN150/FA	8/10/2011	67179	SPEC ED TEACHER	Certificated	T03	05	P	A	1.00	58,959	1.00	45,909
EDN150/FA	8/10/2011	61613	SPEC ED TEACHER	Certificated	T02	05	P	A	1.00	64,482	1.00	42,509
EDN150/FA	8/10/2011	72663	SPEC ED TEACHER	Certificated	T02	05	P	A	1.00	60,195	1.00	42,509
EDN100/AA	8/10/2011	71626	SECONDARY TEACHER	Certificated	T02	05	P	A	1.00	48,008	1.00	42,509
EDN100/AA	8/10/2011	55951	CLERK III	N	SR08	03	T	A	0.75	22,527	0.75	9,995
EDN100/AA	8/11/2011	72378	ELEM TEACHER	Certificated	T02	05	P	A	1.00	62,550	1.00	42,509
EDN100/AA	8/12/2011	602387	ELEM TEACHER	Certificated	T02	05	T	A			1.00	42,509
EDN150/FA	8/12/2011	75847	GEN EDUC/ARTICLE VI TCHR	Certificated	T03	05	T	A			1.00	45,909
EDN100/AA	8/12/2011	61883	COUNSELOR	Certificated	T02	05	P	A			1.00	42,509
EDN150/NB	8/12/2011	801744	EDUC ASST I	Y	SR08	03	T	N			0.75	9,995
EDN100/AA	8/15/2011	69951	ELEM TEACHER	Certificated	T02	05	P	A	1.00	44,452	1.00	42,509
EDN100/AA	8/15/2011	601717	SECONDARY TEACHER	Certificated	T02	05	T	A			1.00	32,222
EDN100/AA	8/15/2011	601001	ELEM TEACHER	Certificated	T02	05	T	A			1.00	42,509
EDN100/AA	8/15/2011	14692	CLERK TYPIST II	N	SR08	03	P	A	1.00	25,668	1.00	13,327
EDN100/DB	8/15/2011	79635	ELEM TEACHER	Certificated	T02	05	T	N			1.00	42,509
EDN100/AA	8/15/2011	602391	ELEM TEACHER	Certificated	T02	05	T	A			1.00	42,509
EDN150/FA	8/15/2011	600173	SPEC ED TEACHER	Certificated	T03	05	T	A			1.00	45,909
EDN150/FA	8/15/2011	602340	SPEC ED TEACHER	Certificated	T03	05	T	A			1.00	45,909
EDN150/FA	8/15/2011	73244	SPEC ED TEACHER	Certificated	T02	05	P	A	1.00	32,713	1.00	42,509
EDN150/FA	8/15/2011	601885	SPEC ED TEACHER	Certificated	T02	05	T	A			1.00	42,509
EDN150/FA	8/15/2011	601887	SPEC ED TEACHER	Certificated	T02	05	T	A			1.00	42,509
EDN100/AA	8/15/2011	63159	SECONDARY TEACHER	Certificated	T02	05	T	A	1.00	43,157	1.00	32,222
EDN150/YC	8/15/2011	58473	BEHAVIORAL HLTH SPCLT IV	N	SR22	13	T	A	1.00	45,576	1.00	49,332
EDN100/DB	8/15/2011	79857	TITLE I LINKER TEACHER	Certificated	T02	05	T	N			1.00	42,509
EDN400/MD	8/15/2011	14668	CAFETERIA HELPER	N	BC02	01	T	N	0.50	16,614	0.50	16,614
EDN150/FA	8/15/2011	55323	EDUC ASST III	Y	SR12	03	P	A	1.00	28,209	1.00	25,030
EDN100/AA	8/16/2011	802204	EDUC ASST III	Y	SR12	03	T	A			0.88	21,901
EDN100/AA	8/16/2011	33125	SCHOOL SECURITY ATTENDANT	N	SR07	03	P	A	1.00	22,331	1.00	20,540
EDN100/AA	8/16/2011	602403	COUNSELOR	Certificated	T03	05	T	A			1.00	45,909
EDN100/AA	8/16/2011	64240	SECONDARY TEACHER	Certificated	T02	05	P	A	1.00	48,008	1.00	42,509

Department of Education
New Hires

Table 16

<u>Prog ID/Org</u>	<u>New Hire Effective Date</u>	<u>Position Number</u>	<u>Position Title</u>	<u>Exempt (Y/N)</u>	<u>SR Level</u>	<u>BU Code</u>	<u>T/P</u>	<u>MOF</u>	<u>Budgeted FTE</u>	<u>Budgeted Salary</u>	<u>Actual FTE</u>	<u>Actual Salary</u>
EDN100/AA	8/16/2011	75025	ELEM TEACHER	Certificated	T03	05	P	A	0.50	25,713	0.50	22,955
EDN400/MD	8/16/2011	58692	CAFETERIA HELPER	N	BC02	01	T	N			0.50	16,614
EDN150/FB	8/16/2011	801444	HSEPARANT FOR DEAF/BLIND (FP)	N	HE05	10	P	A	1.00	33,756	1.00	33,756
EDN150/FA	8/16/2011	71947	GEN EDUC/ARTICLE VI TCHR	Certificated	T02	05	P	A	1.00	62,024	1.00	42,509
EDN150/FA	8/16/2011	64063	SPEC ED TEACHER	Certificated	T02	05	P	A	1.00	45,785	1.00	42,509
EDN100/AA	8/17/2011	802163	DP USER SUPPORT TECH II	N	SR15	03	T	A			1.00	17,528
EDN100/AA	8/17/2011	56806	CLERK TYPIST II	N	SR08	03	P	A	0.50	18,258	0.50	12,834
EDN150/FA	8/17/2011	63289	SPEC ED TEACHER	Certificated	T02	05	P	A	1.00	56,917	1.00	42,509
EDN150/YG	8/17/2011	801837	EDUC ASST III	Y	SR12	03	T	A			1.00	30,036
EDN150/FA	8/17/2011	64643	SPEC ED TEACHER	Certificated	T03	05	P	A	1.00	49,928	1.00	45,909
EDN100/AA	8/18/2011	60731	SECONDARY TEACHER	Certificated	T02	05	P	A	1.00	49,448	1.00	43,785
EDN100/AA	8/18/2011	73374	COUNSELOR	Certificated	T03	05	P	A	1.00	53,483	1.00	45,909
EDN150/YG	8/18/2011	800480	EDUC ASST III	Y	SR12	03	P	A	1.00	26,131	1.00	25,030
EDN150/FA	8/18/2011	68517	GEN EDUC/ARTICLE VI TCHR	Certificated	T02	05	T	A	1.00	48,008	1.00	42,509
EDN100/AA	8/18/2011	69520	ELEM TEACHER	Certificated	T02	05	P	A	1.00	43,157	1.00	42,509
EDN100/AA	8/22/2011	802053	DP USER SUPPORT TECH I	N	SR13	03	T	A			1.00	31,212
EDN100/AA	8/22/2011	64802	SECONDARY TEACHER	Certificated	T02	05	P	A	1.00	52,968	1.00	42,509
EDN100/AA	8/22/2011	17498	SCHOOL CUSTODIAN II	N	BC02	01	P	A	0.50	16,614	0.50	16,614
EDN150/YG	8/22/2011	801836	EDUC ASST II	Y	SR10	03	T	A			1.00	27,756
EDN150/FA	8/22/2011	61974	SPEC ED TEACHER	Certificated	T02	05	P	A	1.00	32,713	1.00	42,509
EDN100/AA	8/22/2011	60779	COUNSELOR	Certificated	T03	05	T	A			1.00	45,909
EDN150/FA	8/22/2011	71939	SPEC ED TEACHER	Certificated	T02	05	T	A			1.00	42,509
EDN100/AA	8/22/2011	65650	SECONDARY TEACHER	Certificated	T02	05	T	A	1.00	49,448	1.00	32,222
EDN150/FA	8/22/2011	62287	SPEC ED TEACHER	Certificated	T02	05	P	A	1.00	52,721	1.00	43,785
EDN150/YC	8/22/2011	58485	BEHAVIORAL HLTH SPCLT IV	N	SR22	13	T	A	1.00	45,576	1.00	47,412
EDN100/BM	8/22/2011	52462	ATHLETIC HLTH CARE TRAINER	Y	SR22	13	P	A	1.00	45,576	1.00	45,576
EDN400/MD	8/22/2011	801155	CLERK TYPIST II	N	SR08	03	P	N	1.00	25,668	1.00	25,668
EDN400/MD	8/22/2011	801154	CLERK TYPIST II	N	SR08	03	T	N	1.00	25,668	1.00	25,668
EDN150/FA	8/23/2011	57579	EDUC ASST II	Y	SR10	03	T	A	0.88	22,865	0.88	20,239
EDN150/FA	8/23/2011	57289	EDUC ASST II	Y	SR10	03	T	A	0.75	19,599	0.75	17,348
EDN400/MD	8/23/2011	801839	CAFETERIA HELPER	N	BC02	01	P	A			0.50	16,614
EDN100/DB	8/23/2011	802052	ACCOUNT CLERK II	N	SR08	03	T	N			0.50	12,834
EDN100/AA	8/24/2011	65490	ELEM TEACHER	Certificated	T02	05	P	A	1.00	49,448	1.00	42,509
EDN150/SA	8/24/2011	3082	OCC THERAPIST IV	N	SR22	13	P	A	1.00	54,636	1.00	23,663
EDN150/FA	8/25/2011	71845	SPEC ED TCHR/PRE-SCHOOL	Certificated	T03	05	P	A	1.00	59,010	1.00	45,909
EDN100/AA	8/26/2011	802092	EDUC ASST III	Y	SR12	03	T	A			1.00	25,030
EDN100/AA	8/29/2011	62631	ELEM TEACHER	Certificated	T03	05	P	A	1.00	51,426	1.00	45,909
EDN100/AA	8/29/2011	71621	SECONDARY TEACHER	Certificated	T02	05	T	A	1.00	49,448	1.00	42,509
EDN100/AA	8/29/2011	65304	SECONDARY TEACHER	Certificated	T03	05	P	A	1.00	50,493	1.00	45,909
EDN150/YG	8/29/2011	801073	EDUC ASST III	Y	SR12	03	P	A			1.00	30,036
EDN150/FA	8/29/2011	61864	SPEC ED TCHR/PRE-SCHOOL	Certificated	T02	05	P	A	1.00	50,743	1.00	42,509
EDN150/FA	8/29/2011	600599	GEN EDUC/ARTICLE VI TCHR	Certificated	T02	05	T	A			1.00	42,509
EDN100/AA	8/29/2011	50454	CLERK TYPIST II	N	SR08	03	P	A	1.00	39,480	0.50	6,664
EDN150/NB	8/29/2011	802222	EDUC ASST I	Y	SR08	03	T	N			1.00	13,327
EDN150/NB	8/30/2011	802223	EDUC ASST I	Y	SR08	03	T	N			1.00	13,327
EDN100/AA	8/30/2011	601819	SECONDARY TEACHER	Certificated	T03	05	T	A			1.00	45,909
EDN150/FA	8/30/2011	73738	SPEC ED TEACHER	Certificated	T03	05	P	A	1.00	40,567	1.00	45,909

<u>Prog ID/Org</u>	<u>New Hire Effective Date</u>	<u>Position Number</u>	<u>Position Title</u>	<u>Exempt (Y/N)</u>	<u>SR Level</u>	<u>BU Code</u>	<u>T/P</u>	<u>MOF</u>	<u>Budgeted FTE</u>	<u>Budgeted Salary</u>	<u>Actual FTE</u>	<u>Actual Salary</u>
EDN150/YC	8/30/2011	800430	SCHOOL PSYCHOLOGIST	Y	SR24	13	P	A	1.00	58,716	1.00	51,312
EDN100/AA	8/31/2011	600865	ELEM TEACHER	Certificated	T02	05	T	A			1.00	42,509
EDN150/FA	8/31/2011	66656	SPEC ED TEACHER	Certificated	T03	05	P	A	1.00	46,609	1.00	45,909
EDN150/NB	9/1/2011	800365	EDUC ASST III	Y	SR12	03	T	N			1.00	25,030
EDN100/AA	9/1/2011	60904	LIBRARIAN	Certificated	T03	05	P	A	1.00	69,646	1.00	45,909
EDN150/FA	9/1/2011	76021	SPEC ED TEACHER	Certificated	T02	05	P	A	1.00	48,008	1.00	32,222
EDN150/FA	9/1/2011	66643	SPEC ED TEACHER	Certificated	T02	05	P	A	1.00	48,008	1.00	42,509
EDN100/AA	9/1/2011	801582	EDUC ASST III	Y	SR12	03	T	A			1.00	25,030
EDN150/FA	9/1/2011	62236	GEN EDUC/ARTICLE VI TCHR	Certificated	T03	05	P	A	1.00	32,713	1.00	45,909
EDN100/AA	9/1/2011	65713	ELEM TEACHER	Certificated	T02	05	P	A	1.00	43,157	1.00	42,509
EDN100/AA	9/1/2011	65451	SECONDARY TEACHER	Certificated	T03	05	P	A	1.00	58,442	1.00	45,909
EDN100/AA	9/1/2011	63783	SECONDARY TEACHER	Certificated	T02	05	T	A	1.00	46,609	1.00	42,509
EDN150/FA	9/1/2011	62337	SPEC ED TEACHER	Certificated	T02	05	P	A	1.00	46,609	1.00	32,222
EDN100/AA	9/1/2011	72615	ELEM TEACHER	Certificated	T02	05	P	A	1.00	43,157	1.00	42,509
EDN150/FA	9/1/2011	30755	EDUC ASST II	Y	SR10	03	P	A	1.00	35,705	1.00	23,130
EDN400/MD	9/1/2011	58897	CAFETERIA HELPER	N	BC02	01	T	N	0.50	16,614	0.50	16,614
EDN100/DB	9/1/2011	800130	EDUC ASST I	Y	SR08	03	T	N			1.00	13,327
EDN400/MD	9/1/2011	57930	CAFETERIA HELPER	N	BC02	01	T	N			0.50	16,614
EDN100/AA	9/1/2011	68324	COUNSELOR	Certificated	T03	05	P	A	1.00	68,351	1.00	45,909
EDN100/AA	9/1/2011	64592	COUNSELOR	Certificated	T02	05	P	A	1.00	79,170	1.00	42,509
EDN100/AA	9/1/2011	602400	SECONDARY TEACHER	Certificated	T03	05	T	A			0.50	17,400
EDN100/AA	9/1/2011	602313	ELEM TEACHER	Certificated	T02	05	T	A			1.00	42,509
EDN150/NB	9/1/2011	801772	EDUC ASST III	Y	SR12	03	T	N			0.75	18,773
EDN100/AA	9/1/2011	802291	CLERK TYPIST II	N	SR08	03	T	A			1.00	12,658
EDN150/YG	9/1/2011	801864	EDUC ASST II	Y	SR10	03	T	A			1.00	23,130
EDN400/MD	9/1/2011	50838	CAFETERIA HELPER	N	BC02	01	T	N			0.50	16,614
EDN150/SA	9/1/2011	58742	SPEECH PATHOLOGIST IV	Y	SR22	13	P	A	1.00	59,043	1.00	45,576
EDN100/AA	9/1/2011	13947	LIBRARY ASSISTANT III	N	SR07	03	P	A	1.00	25,668	1.00	12,798
EDN100/AA	9/1/2011	802131	CLERK TYPIST II	N	SR08	03	T	A			0.50	12,834
EDN500/WA	9/1/2011	48491	CLERK TYPIST II	N	SR08	03	T	W			1.00	25,668
EDN150/NB	9/1/2011	801751	EDUC ASST II	Y	SR10	03	T	N			0.75	17,348
EDN150/SA	9/1/2011	30484	COMMUNICATION AIDE	Y	SR12	03	P	A	1.00	26,131	1.00	25,030
EDN150/FA	9/2/2011	73685	SPEC ED TEACHER	Certificated	T02	05	T	A	1.00	43,157	1.00	32,222
EDN100/AA	9/2/2011	16273	SCHOOL CUSTODIAN II	N	BC02	01	P	A	0.50	16,614	0.50	16,614
EDN150/FA	9/2/2011	71762	SPEC ED TEACHER	Certificated	T03	05	P	A			1.00	45,909
EDN150/FA	9/2/2011	58883	EDUC ASST III	Y	SR12	03	T	A	0.75	19,599	0.75	18,773
EDN100/AA	9/6/2011	801506	SCHOOL SECURITY ATTENDANT	N	SR07	03	P	A	1.00	21,444	1.00	20,540
EDN150/FA	9/6/2011	72043	SPEC ED TEACHER	Certificated	T02	05	P	A	1.00	43,157	1.00	32,222
EDN150/FA	9/6/2011	71710	SPEC ED TEACHER	Certificated	T03	05	P	A	1.00	49,448	1.00	45,909
EDN100/AA	9/6/2011	602388	ELEM TEACHER	Certificated	T03	05	T	A			1.00	45,909
EDN150/FA	9/6/2011	68786	SPEC ED TEACHER	Certificated	T02	05	P	A	1.00	49,448	1.00	42,509
EDN100/AA	9/6/2011	69009	ELEM TEACHER	Certificated	T02	05	P	A	1.00	56,740	1.00	42,509
EDN100/AA	9/6/2011	69736	SECONDARY TEACHER	Certificated	T02	05	P	A	1.00	68,291	1.00	43,785
EDN150/YC	9/6/2011	58288	CLINICAL PSYCHOLOGIST VI	N	SR26	13	P	A	1.00	68,160	1.00	27,378
EDN100/AA	9/6/2011	602415	ELEM TEACHER	Certificated	T03	05	T	A			1.00	45,909
EDN150/NB	9/6/2011	801784	EDUC ASST III	Y	SR12	03	T	N			1.00	25,030
EDN150/YC	9/6/2011	800467	SCHOOL PSYCHOLOGIST	Y	SR24	13	P	A	1.00	58,716	1.00	51,312

Department of Education
New Hires

Table 16

<u>Prog ID/Org</u>	<u>New Hire Effective Date</u>	<u>Position Number</u>	<u>Position Title</u>	<u>Exempt (Y/N)</u>	<u>SR Level</u>	<u>BU Code</u>	<u>T/P</u>	<u>MOF</u>	<u>Budgeted FTE</u>	<u>Budgeted Salary</u>	<u>Actual FTE</u>	<u>Actual Salary</u>
EDN150/YC	9/6/2011	27394	SCHOOL PSYCHOLOGIST	Y	SR24	13	P	A	1.00	54,788	1.00	26,644
EDN150/FA	9/7/2011	61465	SPEC ED TEACHER	Certificated	T02	05	P	A	1.00	49,448	1.00	32,222
EDN100/AA	9/7/2011	601624	ELEM TEACHER	Certificated	T02	05	T	A			1.00	42,509
EDN100/AA	9/7/2011	68265	ELEM TEACHER	Certificated	T03	05	P	A	1.00	80,465	1.00	45,909
EDN150/FA	9/7/2011	66600	SPEC ED TEACHER	Certificated	T03	05	P	A	0.50	24,724	1.00	47,287
EDN150/FA	9/7/2011	76166	SPEC ED TCHR/PRE-SCHOOL	Certificated	T03	05	P	A	1.00	75,733	1.00	47,287
EDN150/YC	9/7/2011	58651	BEHAVIORAL HLTH SPCLT III	N	SR20	13	T	A	1.00	45,576	1.00	21,881
EDN100/AA	9/7/2011	11132	CLERK TYPIST II	N	SR08	03	P	A	1.00	35,064	1.00	25,668
EDN150/FA	9/8/2011	69857	GEN EDUC/ARTICLE VI TCHR	Certificated	T02	05	P	A	1.00	54,558	1.00	42,509
EDN100/AA	9/8/2011	801490	SCHOOL CUSTODIAN II	N	BC02	01	T	A			0.50	16,614
EDN150/FA	9/8/2011	68739	GEN EDUC/ARTICLE VI TCHR	Certificated	T03	05	T	A	1.00	46,609	1.00	47,287
EDN150/YC	9/9/2011	800463	SCHOOL PSYCHOLOGIST	Y	SR24	13	P	A	1.00	58,716	1.00	51,312
EDN100/AA	9/12/2011	71756	SECONDARY TEACHER	Certificated	T02	05	P	A	1.00	48,159	1.00	32,222
EDN150/FA	9/12/2011	62527	SPEC ED TEACHER	Certificated	T02	05	P	A	1.00	58,959	1.00	42,509
EDN100/AA	9/12/2011	802091	EDUC ASST III	Y	SR12	03	T	A			1.00	25,030
EDN150/FA	9/12/2011	30137	EDUC ASST III	Y	SR12	03	P	A	0.75	22,879	0.75	18,773
EDN100/AA	9/12/2011	68672	SECONDARY TEACHER	Certificated	T03	05	P	A	1.00	53,483	1.00	45,909
EDN150/FA	9/12/2011	74183	SPEC ED TEACHER	Certificated	T03	05	P	A	1.00	45,785	1.00	45,909
EDN150/FA	9/12/2011	63505	SPEC ED TEACHER	Certificated	T02	05	T	A			1.00	42,509
EDN100/AA	9/12/2011	72266	ELEM TEACHER	Certificated	T02	05	P	A	1.00	45,785	1.00	42,509
EDN150/FA	9/12/2011	601815	SPEC ED TCHR/PRE-SCHOOL	Certificated	T02	05	T	A			1.00	42,509
EDN100/AA	9/12/2011	602421	ELEM TEACHER	Certificated	T02	05	T	A			1.00	42,509
EDN100/AA	9/13/2011	802090	EDUC ASST III	Y	SR12	03	T	A			1.00	25,030
EDN100/AA	9/13/2011	68882	COUNSELOR	Certificated	T03	05	P	A	1.00	49,448	1.00	47,287
EDN100/AA	9/14/2011	602411	ELEM TEACHER	Certificated	T03	05	T	A			1.00	45,909
EDN100/AA	9/14/2011	602404	ELEM TEACHER	Certificated	T03	05	T	A			1.00	45,909
EDN100/AA	9/14/2011	802324	CLERK TYPIST II	N	SR08	03	T	A			0.50	6,664
EDN100/AA	9/14/2011	71482	COUNSELOR	Certificated	T03	05	P	A	1.00	49,448	1.00	45,909
EDN300/KF	9/14/2011	76185	ASST SUPT,FISCAL SVCS	N	E00	06	P	A	1.00	115,000	1.00	115,000
EDN100/AA	9/15/2011	802332	DP USER SUPPORT TECH II	N	SR15	03	T	A			1.00	17,528
EDN100/AA	9/16/2011	16703	SCHOOL CUSTODIAN II	N	BC02	01	P	A	1.00	33,228	0.50	8,629
EDN400/MD	9/16/2011	801845	CAFETERIA HELPER	N	BC02	01	P	A			0.50	16,614
EDN100/AA	9/16/2011	47013	SCHOOL CUSTODIAN II	N	BC02	01	P	A	1.00	33,228	0.50	16,614
EDN100/AA	9/16/2011	802130	SCHOOL CUSTODIAN II	N	BC02	01	P	A			0.50	16,614
EDN100/AA	9/16/2011	802209	EDUC ASST II	Y	SR10	03	T	A			1.00	23,130
EDN100/AA	9/16/2011	54930	SCHOOL SECURITY ATTENDANT	N	SR07	03	P	A	1.00	26,700	1.00	24,648
EDN100/AA	9/16/2011	16248	SCHOOL CUSTODIAN II	N	BC02	01	P	A	1.00	33,228	1.00	33,228
EDN100/AA	9/16/2011	802132	SCHOOL CUSTODIAN II	N	BC02	01	T	A			1.00	33,228
EDN400/MD	9/16/2011	55503	CAFETERIA HELPER	N	BC02	01	T	N			0.50	16,614
EDN400/MD	9/16/2011	801151	CLERK TYPIST II	N	SR08	03	P	N	1.00	25,668	1.00	25,668
EDN150/YC	9/19/2011	58487	BEHAVIORAL HLTH SPCLT III	N	SR20	13	T	A	1.00	45,576	1.00	42,132
EDN100/AA	9/19/2011	801675	SCHOOL SECURITY ATTENDANT	N	SR07	03	T	A			1.00	12,798
EDN150/NB	9/19/2011	800066	EDUC ASST II	Y	SR10	03	T	N			1.00	23,130
EDN100/AA	9/19/2011	602424	ELEM TEACHER	Certificated	T02	05	T	A			0.50	21,255
EDN100/AA	9/19/2011	62568	SECONDARY TEACHER	Certificated	T02	05	P	A	1.00	62,550	1.00	42,509
EDN150/FA	9/19/2011	62860	GEN EDUC/ARTICLE VI TCHR	Certificated	T02	05	T	A			1.00	42,509
EDN100/AA	9/19/2011	76259	ELEM TEACHER	Certificated	T02	05	P	A	1.00	46,830	1.00	42,509

Department of Education
New Hires

Table 16

Prog ID/Org	New Hire Effective Date	Position Number	Position Title	Exempt (Y/N)	SR Level	BU Code	T/P	MOF	Budgeted FTE	Budgeted Salary	Actual FTE	Actual Salary
EDN100/AA	9/19/2011	62470	SECONDARY TEACHER	Certificated	T03	05	P	A	1.00	60,004	1.00	45,909
EDN300/KO	9/19/2011	12321	PERSONNEL CLERK IV	N	SR11	03	P	A	1.00	36,516	1.00	28,836
EDN150/YC	9/19/2011	800860	BEHAVIORAL HLTH SPCLT III	N	SR20	13	T	A	1.00	45,576	1.00	42,132
EDN100/AA	9/20/2011	71784	ELEM TEACHER	Certificated	T02	05	T	A	1.00	44,452	1.00	42,509
EDN100/AA	9/20/2011	602423	ELEM TEACHER	Certificated	T02	05	T	A			0.50	21,255
EDN100/AA	9/20/2011	802330	DP USER SUPPORT TECH II	N	SR15	03	T	A			1.00	17,528
EDN150/FA	9/20/2011	73354	SPEC ED TEACHER	Certificated	T02	05	P	A	1.00	58,925	1.00	32,222
EDN100/AA	9/21/2011	33170	SCHOOL SECURITY ATTENDANT	N	SR07	03	P	A	1.00	28,209	1.00	20,540
EDN100/AA	9/21/2011	602410	SPEC ED TEACHER	Certificated	T03	05	T	A			1.00	47,287
EDN100/AA	9/22/2011	802226	EDUC ASST III	Y	SR12	03	T	A			0.75	18,773
EDN150/FA	9/22/2011	76321	SPEC ED TCHR/PRE-SCHOOL	Certificated	T02	05	P	A	1.00	60,729	1.00	42,509
EDN150/YG	9/23/2011	801831	EDUC ASST I	Y	SR08	03	T	A			1.00	13,327
EDN150/FA	9/23/2011	73368	SPEC ED TEACHER	Certificated	T02	05	P	A	1.00	49,448	1.00	32,222
EDN100/AA	9/26/2011	69821	ELEM TEACHER	Certificated	T02	05	P	A	1.00	68,351	1.00	43,785
EDN100/AA	9/26/2011	602433	ELEM TEACHER	Certificated	T03	05	T	A			1.00	45,909
EDN100/AA	9/26/2011	602414	ELEM TEACHER	Certificated	T03	05	T	A			1.00	45,909
EDN100/AA	9/26/2011	602422	SECONDARY TEACHER	Certificated	T02	05	T	A			1.00	43,785
EDN150/FA	9/26/2011	62415	SPEC ED TEACHER	Certificated	T03	05	P	A	1.00	43,157	1.00	45,909
EDN150/FA	9/26/2011	64326	SPEC ED TEACHER	Certificated	T02	05	P	A	1.00	49,448	1.00	32,222
EDN100/AA	9/26/2011	74370	COUNSELOR	Certificated	T01	05	P	A	1.00	49,448	1.00	29,662
EDN150/FA	9/26/2011	57338	EDUC ASST II	Y	SR10	03	T	A	0.75	19,599	0.50	11,565
EDN100/AA	9/26/2011	56569	CLERK TYPIST II	N	SR08	03	P	A	0.50	15,018	0.50	12,834
EDN100/AA	9/27/2011	602392	ELEM TEACHER	Certificated	T02	05	T	A			1.00	42,509
EDN100/AA	9/27/2011	62068	SECONDARY TEACHER	Certificated	T02	05	P	A	1.00	55,622	1.00	42,509
EDN100/AA	9/28/2011	601156	ELEM TEACHER	Certificated	T02	05	T	A			1.00	42,509
EDN100/AA	9/29/2011	53194	SCHOOL CUSTODIAN II	N	BC02	01	P	A	0.50	16,614	0.50	8,629
EDN150/YC	9/29/2011	802215	EDUC ASST I	Y	SR08	03	T	A			1.00	13,327
EDN100/AA	9/29/2011	802294	CLERK III	N	SR08	03	T	A			0.50	6,664
EDN150/YC	9/29/2011	58333	BEHAVIORAL HLTH SPCLT III	N	SR20	13	P	A	1.00	45,576	1.00	21,881
EDN150/SA	9/29/2011	33173	SPEECH PATHOLOGIST II	Y	SR18	13	P	A	1.00	69,305	1.00	20,239
EDN100/AA	9/30/2011	60895	ELEM TEACHER	Certificated	T03	05	P	A	1.00	55,622	1.00	45,909
EDN100/AA	9/30/2011	66295	SECONDARY TEACHER	Certificated	T02	05	P	A	1.00	48,574	1.00	43,785
EDN100/AA	9/30/2011	602432	ELEM TEACHER	Certificated	T03	05	T	A			1.00	45,909
EDN150/YC	10/3/2011	801828	BEHAVIORAL HLTH SPCLT IV	N	SR22	13	P	A			1.00	47,412
EDN100/AA	10/3/2011	45313	CLERK TYPIST II	N	SR08	03	P	A	1.00	31,212	1.00	13,327
EDN100/DB	10/3/2011	801055	PERSONNEL CLERK IV	N	SR11	03	T	N			1.00	28,836
EDN100/AA	10/3/2011	802303	SCHOOL CUSTODIAN II	N	BC02	01	P	A			0.50	8,629
EDN100/AA	10/3/2011	802224	DP USER SUPPORT TECH I	N	SR13	03	T	A			1.00	31,212
EDN100/AA	10/3/2011	801543	SCHOOL CUSTODIAN II	N	BC02	01	T	A			0.50	16,614
EDN150/YC	10/3/2011	800438	SCHOOL PSYCHOLOGIST	Y	SR24	13	P	A	1.00	58,716	1.00	51,312
EDN150/SA	10/10/2011	30487	COMMUNICATION AIDE	Y	SR12	03	P	A	1.00	26,131	1.00	25,030
EDN400/MD	10/10/2011	32437	CAFETERIA HELPER	N	BC02	01	T	N	0.50	16,614	0.50	8,629
EDN150/YG	10/10/2011	801853	EDUC ASST III	Y	SR12	03	T	A			1.00	25,030
EDN150/YG	10/10/2011	801860	EDUC ASST II	Y	SR10	03	T	A			1.00	23,130
EDN100/AA	10/10/2011	38979	CLERK TYPIST II	N	SR08	03	P	A	1.00	27,756	1.00	25,668
EDN150/YG	10/10/2011	801863	EDUC ASST II	Y	SR10	03	T	A			1.00	23,130
EDN100/AA	10/11/2011	29471	SCHOOL HEALTH AIDE	N	SR09	03	P	A	1.00	19,620	1.00	18,078

<u>Prog ID/Org</u>	<u>New Hire Effective Date</u>	<u>Position Number</u>	<u>Position Title</u>	<u>Exempt (Y/N)</u>	<u>SR Level</u>	<u>BU Code</u>	<u>T/P</u>	<u>MOF</u>	<u>Budgeted FTE</u>	<u>Budgeted Salary</u>	<u>Actual FTE</u>	<u>Actual Salary</u>
EDN150/FA	10/11/2011	58765	EDUC ASST II	Y	SR10	03	P	A	1.00	30,506	1.00	23,130
EDN150/NB	10/11/2011	58148	EDUC ASST II	Y	SR10	03	T	N			1.00	23,130
EDN100/AA	10/11/2011	600327	SECONDARY TEACHER	Certificated	T03	05	T	A			1.00	34,799
EDN400/MD	10/11/2011	57928	CAFETERIA HELPER	N	BC02	01	T	N			0.50	16,614
EDN100/AA	10/11/2011	61000	ELEM TEACHER	Certificated	T02	05	P	A	1.00	45,747	1.00	42,509
EDN100/AA	10/11/2011	602435	COUNSELOR	Certificated	T03	05	T	A			1.00	45,909
EDN100/AA	10/11/2011	74536	ELEM TEACHER	Certificated	T03	05	P	A	1.00	68,351	1.00	45,909
EDN100/BV	10/11/2011	61880	ELEM TEACHER	Certificated	T02	05	T	A	1.00	32,713	1.00	32,222
EDN100/AA	10/11/2011	64184	COUNSELOR	Certificated	T03	05	P	A	1.00	49,448	1.00	45,909
EDN100/AA	10/11/2011	66980	SECONDARY TEACHER	Certificated	T02	05	P	A	1.00	43,157	0.50	16,111
EDN100/AA	10/11/2011	602417	SECONDARY TEACHER	Certificated	T02	05	T	A			1.00	42,509
EDN100/AA	10/11/2011	600262	ELEM TEACHER	Certificated	T03	05	T	A			1.00	45,909
EDN100/AA	10/11/2011	63026	SECONDARY TEACHER	Certificated	T03	05	P	A	1.00	62,002	1.00	45,909
EDN150/NB	10/11/2011	800183	EDUC ASST III	Y	SR12	03	T	N			1.00	25,030
EDN100/AA	10/11/2011	65393	SECONDARY TEACHER	Certificated	T03	05	P	A	1.00	49,448	1.00	47,287
EDN100/AA	10/11/2011	71735	ELEM TEACHER	Certificated	T02	05	P	A	1.00	68,351	1.00	42,509
EDN150/FA	10/11/2011	71551	SPEC ED TEACHER	Certificated	T02	05	P	A	1.00	43,157	1.00	32,222
EDN100/AA	10/11/2011	68358	ELEM TEACHER	Certificated	T02	05	P	A	1.00	70,400	1.00	42,509
EDN100/AA	10/11/2011	602426	ELEM TEACHER	Certificated	T02	05	T	A			1.00	42,509
EDN100/AA	10/11/2011	601431	SECONDARY TEACHER	Certificated	T02	05	T	A			1.00	42,509
EDN100/AA	10/11/2011	65653	SECONDARY TEACHER	Certificated	T03	05	P	A	1.00	72,513	1.00	45,909
EDN100/AA	10/11/2011	602439	ELEM TEACHER	Certificated	T02	05	T	A			1.00	42,509
EDN100/AA	10/11/2011	62525	LIBRARIAN	Certificated	T03	05	P	A	1.00	63,845	1.00	45,909
EDN150/FA	10/11/2011	64936	SPEC ED TEACHER	Certificated	T02	05	P	A	1.00	32,713	1.00	42,509
EDN100/AA	10/11/2011	602442	ELEM TEACHER	Certificated	T02	05	T	A			0.50	21,255
EDN100/AA	10/11/2011	600089	ELEM TEACHER	Certificated	T02	05	T	A			1.00	42,509
EDN100/AA	10/11/2011	602418	SECONDARY TEACHER	Certificated	T02	05	T	A			1.00	42,509
EDN150/FA	10/11/2011	602288	SPEC ED TEACHER	Certificated	T01	05	T	A			1.00	29,662
EDN150/FA	10/11/2011	67360	SPEC ED TEACHER	Certificated	T02	05	P	A			1.00	42,509
EDN100/AA	10/11/2011	602402	ELEM TEACHER	Certificated	T03	05	T	A			1.00	45,909
EDN150/FA	10/11/2011	63852	SPEC ED TCHR/PRE-SCHOOL	Certificated	T02	05	P	A	1.00	45,785	1.00	42,509
EDN100/AA	10/11/2011	62598	SECONDARY TEACHER	Certificated	T02	05	P	A	1.00	50,931	1.00	32,222
EDN100/AA	10/11/2011	68263	ELEM TEACHER	Certificated	T03	05	P	A	1.00	51,426	1.00	45,909
EDN150/NB	10/11/2011	801027	EDUC ASST III	Y	SR12	03	T	N			1.00	25,030
EDN150/FA	10/11/2011	74415	SPEC ED TEACHER	Certificated	T02	05	P	A	1.00	43,157	1.00	42,509
EDN100/BS	10/11/2011	73398	ROTC INSTRUCTOR	Certificated	ROTC	05	T	A	1.00	86,203	0.50	36,701
EDN150/FA	10/13/2011	57516	EDUC ASST III	Y	SR12	03	T	A	1.00	27,154	1.00	25,030
EDN200/GN	10/14/2011	15229	CLERK TYPIST II	N	SR08	03	P	A	1.00	30,036	1.00	13,327
EDN150/FA	10/17/2011	74428	SPEC ED TEACHER	Certificated	T03	05	P	A	1.00	60,729	1.00	45,909
EDN150/FA	10/17/2011	71295	SPEC ED TEACHER	Certificated	T03	05	P	A	1.00	49,448	1.00	45,909
EDN150/FA	10/17/2011	67656	SPEC ED TEACHER	Certificated	T02	05	P	A	1.00	46,609	1.00	32,222
EDN100/AA	10/17/2011	801373	SCHOOL SECURITY ATTENDANT	N	SR07	03	T	A			1.00	20,540
EDN100/AA	10/17/2011	30595	SCHOOL SECURITY ATTENDANT	N	SR07	03	P	A	1.00	21,444	1.00	12,798
EDN150/FA	10/17/2011	602459	GEN EDUC/ARTICLE VI TCHR	Certificated	T02	05	T	A			1.00	42,509
EDN150/FA	10/17/2011	57359	EDUC ASST II	Y	SR10	03	P	A	0.75	19,599	0.75	17,348
EDN100/AA	10/17/2011	802295	SCHOOL SECURITY ATTENDANT	N	SR07	03	T	A			1.00	12,798
EDN100/AA	10/17/2011	67629	ELEM TEACHER	Certificated	T03	05	P	A	1.00	43,157	1.00	45,909

<u>Prog ID/Org</u>	<u>New Hire Effective Date</u>	<u>Position Number</u>	<u>Position Title</u>	<u>Exempt (Y/N)</u>	<u>SR Level</u>	<u>BU Code</u>	<u>T/P</u>	<u>MOF</u>	<u>Budgeted FTE</u>	<u>Budgeted Salary</u>	<u>Actual FTE</u>	<u>Actual Salary</u>
EDN100/AA	10/17/2011	11128	CLERK TYPIST II	N	SR08	03	P	A	1.00	31,212	1.00	13,327
EDN100/AA	10/17/2011	29495	SCHOOL HEALTH AIDE	N	SR09	03	P	A	1.00	24,786	1.00	18,078
EDN100/AA	10/17/2011	61815	ELEM TEACHER	Certificated	T02	05	P	A	1.00	46,609	1.00	42,509
EDN100/AA	10/17/2011	33167	SCHOOL SECURITY ATTENDANT	N	SR07	03	P	A	1.00	28,209	1.00	20,540
EDN100/AA	10/17/2011	71759	ELEM TEACHER	Certificated	T02	05	P	A	1.00	64,427	1.00	42,509
EDN150/FA	10/17/2011	57763	EDUC ASST III	Y	SR12	03	T	A	0.75	22,879	0.75	18,773
EDN150/FA	10/17/2011	73275	SPEC ED TEACHER	Certificated	T02	05	P	A			1.00	42,509
EDN150/FA	10/17/2011	57336	EDUC ASST I	Y	SR08	03	T	A	0.75	19,599	0.75	9,995
EDN150/FA	10/17/2011	64822	SPEC ED TEACHER	Certificated	T02	05	P	A	1.00	53,483	1.00	42,509
EDN100/AA	10/17/2011	29389	SCHOOL HEALTH AIDE	N	SR09	03	P	A	1.00	21,231	1.00	18,078
EDN100/AA	10/18/2011	63235	SECONDARY TEACHER	Certificated	T02	05	P	A	1.00	62,550	1.00	42,509
EDN100/BV	10/19/2011	74895	SECONDARY TEACHER	Certificated	T02	05	T	A	1.00	32,713	1.00	32,222
EDN100/AA	10/19/2011	64906	SECONDARY TEACHER	Certificated	T02	05	P	A	1.00	65,752	1.00	32,222
EDN150/FA	10/20/2011	602342	SPEC ED TEACHER	Certificated	T02	05	T	A			1.00	32,222
EDN200/GQ	10/20/2011	79209	EDUCATIONAL SPEC II	Y	E07	06	T	N	1.00	87,340	1.00	77,069
EDN100/AA	10/21/2011	65173	ELEM TEACHER	Certificated	T02	05	T	A	1.00	43,157	1.00	42,509
EDN100/AA	10/24/2011	601610	ELEM TEACHER	Certificated	T02	05	T	A			1.00	42,509
EDN100/AA	10/24/2011	67680	SECONDARY TEACHER	Certificated	T03	05	P	A	1.00	56,740	1.00	47,287
EDN100/CB	10/24/2011	59997	CLERK TYPIST II	N	SR08	03	T	A	1.00	25,668	1.00	13,327
EDN100/AA	10/24/2011	602463	COUNSELOR	Certificated	T03	05	T	A			0.50	22,955
EDN150/FA	10/24/2011	60726	SPEC ED TEACHER	Certificated	T03	05	P	A	1.00	33,694	1.00	45,909
EDN100/AA	10/24/2011	61156	ELEM TEACHER	Certificated	T03	05	P	A	1.00	46,609	1.00	45,909
EDN100/AA	10/24/2011	801637	DP USER SUPPORT TECH II	N	SR15	03	P	A			1.00	17,528
EDN150/FA	10/25/2011	65943	GEN EDUC/ARTICLE VI TCHR	Certificated	T02	05	P	A	1.00	46,609	1.00	32,222
EDN100/AA	10/25/2011	602413	ELEM TEACHER	Certificated	T03	05	T	A			1.00	45,909
EDN400/MB	10/25/2011	50316	PROFESSIONAL TRAINEE II	N	SR18	13	T	N	1.00	70,224	1.00	38,988
EDN150/YG	10/26/2011	802281	EDUC ASST III	Y	SR12	03	T	A			1.00	25,030
EDN150/FA	10/27/2011	61209	SPEC ED TEACHER	Certificated	T03	05	P	A	1.00	52,721	1.00	45,909
EDN100/AA	10/31/2011	602456	SPEC ED TEACHER	Certificated	T03	05	T	A			0.50	22,955
EDN100/AA	10/31/2011	67212	ELEM TEACHER	Certificated	T02	05	P	A	1.00	60,729	1.00	42,509
EDN100/AA	10/31/2011	65770	ELEM TEACHER	Certificated	T03	05	P	A	1.00	72,513	1.00	45,909
EDN150/YG	10/31/2011	801834	EDUC ASST II	Y	SR10	03	T	A			1.00	27,756
EDN100/DB	10/31/2011	801103	PERSONNEL CLERK V	N	SR13	03	T	N			1.00	16,211
EDN150/FA	10/31/2011	71035	SPEC ED TEACHER	Certificated	T02	05	P	A	1.00	32,713	1.00	32,222
EDN100/AA	11/1/2011	801722	CLERK III	N	SR08	03	T	A			1.00	25,668
EDN100/AA	11/1/2011	29451	SCHOOL HEALTH AIDE	N	SR09	03	P	A	1.00	18,873	1.00	18,078
EDN150/FA	11/1/2011	56057	EDUC ASST II	Y	SR10	03	P	A	0.75	22,879	0.75	17,348
EDN100/AA	11/1/2011	602453	COUNSELOR	Certificated	T03	05	T	A			1.00	45,909
EDN150/FA	11/1/2011	74107	SPEC ED TCHR/PRE-SCHOOL	Certificated	T02	05	P	A			1.00	32,222
EDN150/FA	11/1/2011	801216	EDUC ASST II	Y	SR10	03	T	A	1.00	26,131	1.00	23,130
EDN100/AA	11/1/2011	802175	CLERK II	N	SR06	03	T	A			1.00	23,688
EDN100/AA	11/1/2011	68696	ELEM TEACHER	Certificated	T03	05	P	A	1.00	63,845	1.00	45,909
EDN100/AA	11/1/2011	68508	SECONDARY TEACHER	Certificated	T02	05	P	A	1.00	49,448	1.00	42,509
EDN150/FA	11/1/2011	65189	SPEC ED TEACHER	Certificated	T02	05	P	A	1.00	49,448	1.00	42,509
EDN150/FA	11/1/2011	73678	SPEC ED TCHR/PRE-SCHOOL	Certificated	T02	05	P	A	1.00	51,426	1.00	42,509
EDN100/BV	11/1/2011	65378	ELEM TEACHER	Certificated	T02	05	T	A			1.00	32,222
EDN100/AA	11/1/2011	802202	EDUC ASST III	Y	SR12	03	T	A			0.75	18,773

<u>Prog ID/Org</u>	<u>New Hire Effective Date</u>	<u>Position Number</u>	<u>Position Title</u>	<u>Exempt (Y/N)</u>	<u>SR Level</u>	<u>BU Code</u>	<u>T/P</u>	<u>MOF</u>	<u>Budgeted FTE</u>	<u>Budgeted Salary</u>	<u>Actual FTE</u>	<u>Actual Salary</u>
EDN100/AA	11/1/2011	801841	GEN PROF IV	N	SR22	13	T	A			0.50	22,788
EDN150/YC	11/1/2011	58309	BEHAVIORAL HLTH SPCLT IV	N	SR22	13	P	A	1.00	55,500	1.00	51,312
EDN150/YG	11/1/2011	59560	BEHAVIORAL HLTH SPCLT III	N	SR20	13	P	A	1.00	47,412	1.00	21,881
EDN150/SA	11/1/2011	801320	EDUCATIONAL INTERPRETER I	N	SR12	03	P	A	1.00	30,036	1.00	30,036
EDN150/FA	11/2/2011	62955	GEN EDUC/ARTICLE VI TCHR	Certificated	T02	05	P	A	1.00	56,740	1.00	32,222
EDN150/NB	11/2/2011	801457	EDUC ASST II	Y	SR10	03	T	N			1.00	23,130
EDN100/AA	11/2/2011	59963	SCHOOL SECURITY ATTENDANT	N	SR07	03	T	A	1.00	21,444	1.00	20,540
EDN150/YG	11/2/2011	802284	EDUC ASST II	Y	SR10	03	T	A			1.00	23,130
EDN100/AA	11/3/2011	602409	SECONDARY TEACHER	Certificated	T02	05	T	A			0.50	16,111
EDN150/FA	11/3/2011	65253	GEN EDUC/ARTICLE VI TCHR	Certificated	T02	05	P	A	1.00	46,830	1.00	32,222
EDN150/FA	11/4/2011	71263	SPEC ED TEACHER	Certificated	T02	05	P	A	1.00	46,609	1.00	32,222
EDN100/AA	11/4/2011	71704	ELEM TEACHER	Certificated	T02	05	T	A	1.00	43,157	1.00	42,509
EDN150/FA	11/7/2011	601946	GEN EDUC/ARTICLE VI TCHR	Certificated	T02	05	T	A			1.00	42,509
EDN400/MD	11/7/2011	51654	CAFETERIA HELPER	N	BC02	01	T	N	0.50	16,614	0.50	16,614
EDN150/FA	11/8/2011	800069	EDUC ASST II	Y	SR10	03	T	A	1.00	28,209	1.00	23,130
EDN400/MD	11/8/2011	50901	FOOD SERVICES DRIVER	N	BC03	01	T	N	1.00	34,164	1.00	34,164
EDN150/FA	11/9/2011	57790	EDUC ASST I	Y	SR08	03	P	A	0.75	19,599	0.75	16,043
EDN400/MD	11/9/2011	9536	CAFETERIA HELPER	N	BC02	01	T	A			0.50	16,614
EDN150/FA	11/9/2011	53043	EDUC ASST II	Y	SR10	03	P	A	1.00	31,769	1.00	23,130
EDN100/AA	11/10/2011	29400	SCHOOL HEALTH AIDE	N	SR09	03	P	A	1.00	21,231	1.00	18,078
EDN100/AA	11/10/2011	65644	COUNSELOR	Certificated	T03	05	T	A	1.00	51,426	1.00	45,909
EDN100/AA	11/14/2011	802255	EDUC ASST III	Y	SR12	03	T	A			1.00	25,030
EDN100/AA	11/14/2011	27201	CLERK TYPIST II	N	SR08	03	P	A	1.00	27,756	1.00	25,668
EDN150/FA	11/14/2011	602420	SPEC ED TEACHER	Certificated	T02	05	T	A			1.00	32,222
EDN100/AA	11/14/2011	602470	COUNSELOR	Certificated	T03	05	T	A			1.00	45,909
EDN100/AA	11/14/2011	801621	EDUC ASST I	Y	SR08	03	T	A			1.00	21,390
EDN150/FA	11/14/2011	75725	SPEC ED TEACHER	Certificated	T02	05	P	A	1.00	46,609	1.00	42,509
EDN400/MD	11/14/2011	12368	CAFETERIA HELPER	N	BC02	01	T	A			0.50	16,614
EDN100/AA	11/14/2011	16254	SCHOOL CUSTODIAN II	N	BC02	01	P	A	0.50	16,614	0.50	16,614
EDN150/FA	11/14/2011	73675	SPEC ED TCHR/PRE-SCHOOL	Certificated	T03	05	T	A	1.00	48,008	1.00	45,909
EDN400/MD	11/14/2011	54661	CAFETERIA HELPER	N	BC02	01	T	N			0.50	16,614
EDN100/AA	11/16/2011	802320	SCHOOL SECURITY ATTENDANT	N	SR07	03	T	A			1.00	20,540
EDN100/AA	11/16/2011	802321	CLERK TYPIST II	N	SR08	03	T	A			1.00	25,668
EDN150/FA	11/16/2011	801895	EDUC ASST III	Y	SR12	03	T	A			0.50	12,515
EDN100/DB	11/16/2011	801550	EDUC ASST III	Y	SR12	03	T	N			1.00	25,030
EDN150/FA	11/16/2011	800780	EDUC ASST II	Y	SR10	03	T	A	0.75	19,599	0.75	17,348
EDN100/AA	11/16/2011	802189	SCHOOL CUSTODIAN II	N	BC02	01	T	A			0.50	16,614
EDN150/FA	11/16/2011	57911	EDUC ASST II	Y	SR10	03	T	A	0.75	22,026	0.75	17,348
EDN150/FA	11/16/2011	65453	GEN EDUC/ARTICLE VI TCHR	Certificated	T03	05	P	A	1.00	79,170	1.00	45,909
EDN100/AA	11/16/2011	64784	SECONDARY TEACHER	Certificated	T02	05	P	A	1.00	43,157	1.00	42,509
EDN150/YG	11/16/2011	801856	EDUC ASST II	Y	SR10	03	T	A			1.00	23,130
EDN150/YG	11/16/2011	801865	EDUC ASST III	Y	SR12	03	T	A			1.00	25,030
EDN400/MD	11/16/2011	47307	SCHOOL BAKER	N	BC06	01	P	A	1.00	38,436	1.00	38,436
EDN400/MD	11/16/2011	801150	CLERK TYPIST II	N	SR08	03	T	N	1.00	25,668	1.00	25,668
EDN150/FA	11/16/2011	57423	EDUC ASST II	Y	SR10	03	T	A	0.75	19,599	0.75	17,348
EDN300/KD	11/16/2011	59953	SECRETARY IV	N	SR18	03	P	A	1.00	41,040	1.00	37,968
EDN150/NB	11/17/2011	801132	EDUC ASST III	Y	SR12	03	T	N			1.00	25,030

<u>Prog ID/Org</u>	<u>New Hire Effective Date</u>	<u>Position Number</u>	<u>Position Title</u>	<u>Exempt (Y/N)</u>	<u>SR Level</u>	<u>BU Code</u>	<u>T/P</u>	<u>MOF</u>	<u>Budgeted FTE</u>	<u>Budgeted Salary</u>	<u>Actual FTE</u>	<u>Actual Salary</u>
EDN100/AA	11/17/2011	62447	ELEM TEACHER	Certificated	T03	05	P	A	1.00	75,983	1.00	45,909
EDN100/AA	11/18/2011	29378	SCHOOL HEALTH AIDE	N	SR09	03	P	A	1.00	21,231	1.00	18,078
EDN100/AA	11/21/2011	29793	SCHOOL HEALTH AIDE	N	SR09	03	P	A	1.00	24,786	1.00	18,078
EDN100/AA	11/21/2011	802418	DP USER SUPPORT TECH II	N	SR15	03	T	A			1.00	17,528
EDN150/SA	11/21/2011	30578	OCC THERAPIST IV	N	SR22	13	P	A	1.00	54,636	1.00	45,576
EDN100/BM	11/21/2011	48257	ATHLETIC HLTH CARE TRAINER	Y	SR22	13	P	A	1.00	45,576	1.00	23,663
EDN150/YC	11/21/2011	58406	BEHAVIORAL HLTH SPCLT III	N	SR20	13	P	A	1.00	57,708	1.00	21,881
EDN100/AA	11/23/2011	56493	CLERK TYPIST II	N	SR08	03	P	A	1.00	42,684	0.50	12,834
EDN100/AA	11/25/2011	16615	SCHOOL CUSTODIAN II	N	BC02	01	P	A	1.00	33,228	1.00	33,228
EDN100/AA	11/28/2011	13947	LIBRARY ASSISTANT III	N	SR07	03	P	A	1.00	25,668	1.00	12,809
EDN100/BJ	11/28/2011	68095	SECONDARY TEACHER	Certificated	T02	05	P	A			1.00	42,509
EDN150/YC	11/28/2011	59135	CLERK TYPIST II	N	SR08	03	T	A	0.50	12,834	0.50	12,834
EDN400/OC	11/28/2011	17092	CARPENTER I	N	BC09	01	P	A	1.00	44,544	1.00	44,544
EDN150/FA	11/28/2011	57030	EDUC ASST III	Y	SR12	03	T	A			0.75	18,773
EDN100/AA	11/29/2011	602482	ELEM TEACHER	Certificated	T02	05	T	A			0.50	21,255
EDN300/KO	12/1/2011	69930	PERS REGIONAL OFFICER II	Certificated	E07	06	P	A	1.00	78,146	1.00	77,069
EDN100/AA	12/1/2011	802297	CLERK II	N	SR06	03	T	A			1.00	23,688
EDN100/AA	12/1/2011	29299	SCHOOL HEALTH AIDE	N	SR09	03	P	A	1.00	24,786	1.00	18,078
EDN100/AA	12/1/2011	800978	CLERK TYPIST II	N	SR08	03	P	A	0.50	15,018	0.50	12,834
EDN100/AA	12/1/2011	802260	CLERK TYPIST II	N	SR08	03	T	A			0.50	12,834
EDN100/AA	12/1/2011	29462	SCHOOL HEALTH AIDE	N	SR09	03	P	A	1.00	22,919	1.00	18,078
EDN300/KD	12/1/2011	601797	DOE AUDITOR SPEC II	Certificated	E07	06	P	A	1.00	-	1.00	77,069
EDN150/FA	12/1/2011	52735	EDUC ASST II	Y	SR10	03	P	A	1.00	28,209	1.00	23,130
EDN150/FA	12/1/2011	56128	EDUC ASST II	Y	SR10	03	P	A	0.75	20,366	0.75	17,348
EDN100/AA	12/1/2011	49550	SCHOOL HEALTH AIDE	N	SR09	03	P	A	1.00	29,010	1.00	18,078
EDN150/FA	12/1/2011	602447	SPEC ED TEACHER	Certificated	T02	05	T	A			1.00	42,509
EDN400/MD	12/1/2011	802414	CAFETERIA HELPER	N	BC02	01	T	N			0.50	8,629
EDN100/AA	12/1/2011	800715	CLERK TYPIST II	N	SR08	03	T	A	0.50	12,834	0.50	6,664
EDN100/AA	12/1/2011	801063	CLERK TYPIST II	N	SR08	03	T	A	0.50	12,834	0.50	6,664
EDN150/FA	12/1/2011	68748	GEN EDUC/ARTICLE VI TCHR	Certificated	T02	05	P	A	1.00	48,008	1.00	42,509
EDN100/AA	12/1/2011	600100	ELEM TEACHER	Certificated	T02	05	T	A			1.00	43,785
EDN100/AA	12/1/2011	802234	SCHOOL CUSTODIAN II	N	BC02	01	T	A			0.50	16,614
EDN200/GN	12/1/2011	60084	COMPLX SCH RENEW SPEC II	Certificated	E07	06	P	A	1.00	103,196	1.00	83,772
EDN100/AA	12/1/2011	55954	CLERK III	N	SR08	03	T	A	1.00	30,036	1.00	25,668
EDN100/AA	12/2/2011	602451	ELEM TEACHER	Certificated	T02	05	T	A			1.00	42,509
EDN150/FA	12/5/2011	32483	EDUC ASST III	Y	SR12	03	P	A	1.00	28,209	1.00	25,030
EDN150/FB	12/5/2011	800645	EDUC ASST II	Y	SR10	03	P	A	1.00	27,154	1.00	23,130
EDN100/AA	12/5/2011	61135	ELEM TEACHER	Certificated	T02	05	T	A	1.00	48,008	1.00	42,509
EDN150/FA	12/5/2011	66749	SPEC ED TEACHER	Certificated	T02	05	P	A	1.00	40,567	1.00	32,222
EDN150/FA	12/5/2011	602460	GEN EDUC/ARTICLE VI TCHR	Certificated	T02	05	T	A			1.00	42,509
EDN150/FA	12/5/2011	800607	EDUC ASST III	Y	SR12	03	T	A	1.00	26,131	1.00	25,030
EDN150/YC	12/5/2011	58654	BEHAVIORAL HLTH SPCLT III	N	SR20	13	T	A	1.00	45,576	1.00	42,132
EDN400/MD	12/5/2011	44430	CAFETERIA HELPER	N	BC02	01	T	N	1.00	33,228	1.00	33,228
EDN150/NB	12/5/2011	58598	EDUC ASST II	Y	SR10	03	T	N			1.00	23,130
EDN100/AA	12/6/2011	802182	EDUC ASST III	Y	SR12	03	T	A			1.00	25,030
EDN100/AA	12/6/2011	602393	SPEC ED TEACHER	Certificated	T02	05	T	A			1.00	32,222
EDN100/AA	12/6/2011	600860	COUNSELOR	Certificated	T03	05	T	A			1.00	45,909

<u>Prog ID/Org</u>	<u>New Hire Effective Date</u>	<u>Position Number</u>	<u>Position Title</u>	<u>Exempt (Y/N)</u>	<u>SR Level</u>	<u>BU Code</u>	<u>T/P</u>	<u>MOF</u>	<u>Budgeted FTE</u>	<u>Budgeted Salary</u>	<u>Actual FTE</u>	<u>Actual Salary</u>
EDN100/AA	12/6/2011	802336	DP USER SUPPORT TECH II	N	SR15	03	T	A			1.00	17,528
EDN150/FA	12/8/2011	57037	EDUC ASST II	Y	SR10	03	T	A	1.00	29,368	1.00	23,130
EDN150/FA	12/9/2011	53007	EDUC ASST II	Y	SR10	03	P	A	0.75	19,599	0.75	17,348
EDN100/AA	12/12/2011	802424	DP USER SUPPORT TECH II	N	SR15	03	T	A			1.00	17,528
EDN400/OC	12/12/2011	17093	CARPENTER I	N	BC09	01	P	A	1.00	48,096	1.00	44,544
EDN150/FA	12/13/2011	74656	SPEC ED TEACHER	Certificated	T02	05	P	A	1.00	32,713	1.00	32,222
EDN150/YC	12/14/2011	58747	BEHAVIORAL HLTH SPCLT IV	N	SR22	13	P	A	1.00	47,412	1.00	47,412
EDN100/AA	12/15/2011	801698	DP USER SUPPORT TECH II	N	SR15	03	T	A			1.00	17,528
EDN100/AA	12/16/2011	802192	CLERK TYPIST II	N	SR08	03	T	A			1.00	25,668
EDN150/FA	12/16/2011	802331	EDUC ASST II	Y	SR10	03	P	A			0.75	17,348
EDN300/KD	12/16/2011	60001	ADM ASST TO THE SUPT	N	E10	06	P	A	1.00	123,642	1.00	99,408
EDN100/CB	12/16/2011	50395	PERSONNEL CLERK IV	N	SR11	03	P	A	1.00	30,036	1.00	14,969
EDN150/YC	12/19/2011	58325	BEHAVIORAL HLTH SPCLT III	N	SR20	13	P	A	1.00	51,312	1.00	42,132
EDN300/KO	12/19/2011	59128	PERSONNEL CLERK V	N	SR13	03	P	A	1.00	37,968	1.00	16,211
EDN100/AA	12/19/2011	41279	SCHOOL CUSTODIAN II	N	BC02	01	P	A	0.50	16,614	0.50	8,629
EDN400/YA	12/19/2011	801102	ACCOUNT CLERK II	N	SR08	03	P	A	1.00	28,836	1.00	25,668
EDN100/AA	12/20/2011	802427	CLERK I	N	SR04	03	T	A			0.50	5,697
EDN100/AA	12/27/2011	4982	ACCOUNT CLERK IV	N	SR13	03	P	A	1.00	35,064	1.00	31,212
EDN150/FA	1/3/2012	47141	EDUC ASST I	Y	SR08	03	P	A	1.00	31,769	1.00	21,390
EDN100/AA	1/3/2012	55116	CLERK II	N	SR06	03	T	A			1.00	23,688
EDN100/AA	1/3/2012	14710	CLERK TYPIST II	N	SR08	03	P	A	1.00	25,668	1.00	25,668
EDN100/AA	1/3/2012	23046	SCHOOL ADM SERVICES ASST IV	N	SR18	04	P	A	1.00	54,012	1.00	19,710
EDN100/AA	1/3/2012	46292	ACCOUNT CLERK II	N	SR08	03	P	A	1.00	25,668	1.00	13,327
EDN150/FA	1/3/2012	55383	EDUC ASST II	Y	SR10	03	P	A	0.75	19,599	0.75	17,348
EDN150/YG	1/3/2012	801524	EDUC ASST II	Y	SR10	03	T	A			1.00	23,130
EDN150/YC	1/3/2012	802217	EDUC ASST I	Y	SR08	03	T	A			1.00	13,327
EDN100/AA	1/3/2012	802278	SCHOOL SECURITY ATTENDANT	N	SR07	03	T	A			1.00	20,540
EDN100/AA	1/3/2012	72635	ELEM TEACHER	Certificated	T03	05	P	A	1.00	49,448	1.00	45,909
EDN150/YG	1/3/2012	802281	EDUC ASST III	Y	SR12	03	T	A			1.00	25,030
EDN150/FB	1/3/2012	800648	EDUC ASST II	Y	SR10	03	P	A	1.00	26,131	1.00	23,130
EDN150/YC	1/3/2012	58750	BEHAVIORAL HLTH SPCLT IV	N	SR22	13	P	A	1.00	55,500	1.00	51,312
EDN150/YG	1/3/2012	802283	EDUC ASST II	Y	SR10	03	T	A			1.00	23,130
EDN150/FA	1/3/2012	67506	GEN EDUC/ARTICLE VI TCHR	Certificated	T02	05	P	A	1.00	48,008	1.00	32,222
EDN150/FA	1/3/2012	801893	EDUC ASST II	Y	SR10	03	T	A			0.75	17,348
EDN100/AA	1/3/2012	45313	CLERK TYPIST II	N	SR08	03	P	A	1.00	31,212	1.00	25,668
EDN150/YG	1/3/2012	802286	EDUC ASST II	Y	SR10	03	T	A			1.00	23,130
EDN400/OJ	1/3/2012	802259	PRGM SPCLT V	N	SR24	13	P	A			1.00	51,312
EDN100/AA	1/4/2012	602512	ELEM TEACHER	Certificated	T03	05	T	A			1.00	45,909
EDN150/YG	1/4/2012	801705	EDUC ASST I	Y	SR08	03	T	A			1.00	13,327
EDN100/AA	1/4/2012	65079	ELEM TEACHER	Certificated	T03	05	P	A	1.00	72,513	1.00	45,909
EDN100/DB	1/4/2012	800127	EDUC ASST I	Y	SR08	03	T	N			1.00	13,327
EDN100/AA	1/4/2012	60612	SECONDARY TEACHER	Certificated	T03	05	P	A	1.00	45,785	1.00	45,909
EDN150/FA	1/4/2012	62646	SPEC ED TEACHER	Certificated	T02	05	P	A	1.00	45,785	1.00	42,509
EDN100/AA	1/4/2012	73200	COUNSELOR	Certificated	T03	05	T	A	1.00	46,609	1.00	45,909
EDN150/FA	1/4/2012	68988	SPEC ED TEACHER	Certificated	T03	05	P	A	1.00	50,743	1.00	45,909
EDN100/AA	1/4/2012	62855	SECONDARY TEACHER	Certificated	T02	05	P	A	1.00	62,024	1.00	32,222
EDN150/FA	1/4/2012	600191	SPEC ED TEACHER	Certificated	T02	05	T	A			1.00	32,222

<u>Prog ID/Org</u>	<u>New Hire Effective Date</u>	<u>Position Number</u>	<u>Position Title</u>	<u>Exempt (Y/N)</u>	<u>SR Level</u>	<u>BU Code</u>	<u>T/P</u>	<u>MOF</u>	<u>Budgeted FTE</u>	<u>Budgeted Salary</u>	<u>Actual FTE</u>	<u>Actual Salary</u>
EDN100/AA	1/4/2012	62139	SECONDARY TEACHER	Certificated	T02	05	T	A	1.00	49,448	1.00	42,509
EDN100/DB	1/4/2012	800126	EDUC ASST I	Y	SR08	03	T	N			1.00	13,327
EDN100/AA	1/4/2012	602514	ELEM TEACHER	Certificated	T02	05	T	A			1.00	42,509
EDN150/FA	1/4/2012	56849	EDUC ASST III	Y	SR12	03	T	A	1.00	27,154	1.00	25,030
EDN100/AA	1/4/2012	69055	COUNSELOR	Certificated	T03	05	P	A	1.00	70,400	0.50	22,955
EDN100/AA	1/4/2012	600416	ELEM TEACHER	Certificated	T03	05	T	A			0.50	22,955
EDN150/FA	1/4/2012	602464	SPEC ED TEACHER	Certificated	T02	05	T	A			1.00	42,509
EDN150/FA	1/4/2012	60197	SPEC ED TEACHER	Certificated	T02	05	P	A	1.00	32,713	1.00	42,509
EDN100/AA	1/4/2012	61548	ELEM TEACHER	Certificated	T03	05	P	A	1.00	79,170	1.00	45,909
EDN100/AA	1/4/2012	66250	ELEM TEACHER	Certificated	T02	05	P	A	1.00	58,483	1.00	42,509
EDN100/AA	1/4/2012	66552	ELEM TEACHER	Certificated	T02	05	P	A	1.00	79,170	1.00	42,509
EDN150/FA	1/4/2012	62153	SPEC ED TEACHER	Certificated	T02	05	P	A	1.00	65,778	1.00	32,222
EDN150/YG	1/4/2012	801353	HUMAN SVCS PROF III	N	SR20	13	P	A			1.00	21,881
EDN150/FA	1/4/2012	602487	GEN EDUC/ARTICLE VI TCHR	Certificated	T02	05	T	A			1.00	42,509
EDN100/AA	1/4/2012	801699	EDUC ASST II	Y	SR10	03	T	A			1.00	23,130
EDN150/FA	1/4/2012	602485	SPEC ED TCHR/PRE-SCHOOL	Certificated	T02	05	T	A			1.00	42,509
EDN150/FA	1/4/2012	64394	GEN EDUC/ARTICLE VI TCHR	Certificated	T02	05	P	A	1.00	43,157	1.00	42,509
EDN150/FA	1/4/2012	67672	SPEC ED TEACHER	Certificated	T02	05	P	A	1.00	53,483	1.00	42,509
EDN100/AA	1/4/2012	602473	ELEM TEACHER	Certificated	T02	05	T	A			1.00	42,509
EDN100/AA	1/4/2012	66710	ELEM TEACHER	Certificated	T02	05	P	A	1.00	50,743	1.00	42,509
EDN150/FA	1/4/2012	67024	SPEC ED TCHR/PRE-SCHOOL	Certificated	T02	05	P	A	1.00	60,195	1.00	42,509
EDN100/AA	1/4/2012	602472	ELEM TEACHER	Certificated	T02	05	T	A			0.50	21,255
EDN100/AA	1/4/2012	602509	ELEM TEACHER	Certificated	T02	05	T	A			1.00	42,509
EDN100/AA	1/4/2012	71778	SECONDARY TEACHER	Certificated	T03	05	T	A	1.00	49,448	1.00	45,909
EDN100/AA	1/4/2012	602469	ELEM TEACHER	Certificated	T02	05	T	A			1.00	42,509
EDN150/FA	1/4/2012	73738	SPEC ED TEACHER	Certificated	T02	05	P	A	1.00	40,567	1.00	32,222
EDN100/AA	1/4/2012	69631	SECONDARY TEACHER	Certificated	T03	05	P	A	1.00	68,351	1.00	45,909
EDN150/FA	1/4/2012	72689	GEN EDUC/ARTICLE VI TCHR	Certificated	T03	05	P	A	1.00	68,351	1.00	45,909
EDN150/FA	1/4/2012	64956	GEN EDUC/ARTICLE VI TCHR	Certificated	T03	05	P	A	1.00	46,609	1.00	45,909
EDN100/AA	1/4/2012	61702	SECONDARY TEACHER	Certificated	T02	05	P	A	1.00	79,170	1.00	32,222
EDN150/FA	1/4/2012	48817	EDUC ASST II	Y	SR10	03	T	A	0.75	19,599	0.75	17,348
EDN100/AA	1/4/2012	602510	ELEM TEACHER	Certificated	T02	05	T	A			1.00	42,509
EDN150/FA	1/4/2012	65993	SPEC ED TEACHER	Certificated	T02	05	P	A	1.00	55,622	1.00	42,509
EDN100/BJ	1/4/2012	74261	SECONDARY TEACHER	Certificated	T03	05	P	A			1.00	45,909
EDN100/AA	1/4/2012	63948	ELEM TEACHER	Certificated	T02	05	P	A	1.00	68,351	1.00	42,509
EDN100/AA	1/4/2012	602513	ELEM TEACHER	Certificated	T02	05	T	A			1.00	42,509
EDN150/FA	1/4/2012	76151	SPEC ED TEACHER	Certificated	T02	05	T	A	1.00	49,448	1.00	42,509
EDN100/AA	1/4/2012	60494	ELEM TEACHER	Certificated	T02	05	P	A	1.00	56,740	1.00	42,509
EDN100/AA	1/4/2012	60365	SECONDARY TEACHER	Certificated	T02	05	P	A	1.00	68,351	1.00	42,509
EDN100/AA	1/4/2012	74454	SECONDARY TEACHER	Certificated	T02	05	P	A	1.00	79,170	1.00	42,509
EDN100/AA	1/4/2012	63747	ELEM TEACHER	Certificated	T02	05	P	A	1.00	45,785	1.00	42,509
EDN150/FA	1/4/2012	600737	SPEC ED TEACHER	Certificated	T02	05	T	A			1.00	42,509
EDN100/AA	1/4/2012	600220	SECONDARY TEACHER	Certificated	T02	05	T	A			1.00	42,509
EDN100/AA	1/4/2012	61112	ELEM TEACHER	Certificated	T02	05	P	A	1.00	70,400	1.00	42,509
EDN100/AA	1/4/2012	64741	ELEM TEACHER	Certificated	T02	05	P	A	1.00	45,785	1.00	42,509
EDN100/AA	1/4/2012	602532	ELEM TEACHER	Certificated	T02	05	T	A			0.50	21,255
EDN100/AA	1/4/2012	602508	ELEM TEACHER	Certificated	T02	05	T	A			1.00	42,509

<u>Prog ID/Org</u>	<u>New Hire Effective Date</u>	<u>Position Number</u>	<u>Position Title</u>	<u>Exempt (Y/N)</u>	<u>SR Level</u>	<u>BU Code</u>	<u>T/P</u>	<u>MOF</u>	<u>Budgeted FTE</u>	<u>Budgeted Salary</u>	<u>Actual FTE</u>	<u>Actual Salary</u>
EDN100/AA	1/4/2012	64237	ELEM TEACHER	Certificated	T02	05	T	A	1.00	44,452	1.00	42,509
EDN100/AA	1/4/2012	61256	ELEM TEACHER	Certificated	T02	05	P	A	1.00	66,359	1.00	42,509
EDN100/AA	1/4/2012	65429	SECONDARY TEACHER	Certificated	T02	05	P	A	1.00	50,493	1.00	42,509
EDN100/AA	1/4/2012	69064	ELEM TEACHER	Certificated	T02	05	P	A	1.00	66,359	1.00	42,509
EDN100/AA	1/4/2012	60881	ELEM TEACHER	Certificated	T02	05	P	A	1.00	60,662	1.00	42,509
EDN100/AA	1/4/2012	66768	SECONDARY TEACHER	Certificated	T02	05	P	A	1.00	49,448	1.00	42,509
EDN100/AA	1/4/2012	69670	ELEM TEACHER	Certificated	T02	05	P	A	1.00	69,646	1.00	42,509
EDN100/AA	1/4/2012	64804	SECONDARY TEACHER	Certificated	T02	05	P	A	1.00	74,688	1.00	42,509
EDN100/AA	1/4/2012	74400	ELEM TEACHER	Certificated	T02	05	T	A	1.00	51,426	1.00	42,509
EDN150/FA	1/4/2012	71327	SPEC ED TEACHER	Certificated	T03	05	P	A	1.00	58,959	1.00	47,287
EDN100/AA	1/4/2012	67905	COUNSELOR	Certificated	T03	05	P	A	1.00	60,729	1.00	45,909
EDN100/AA	1/4/2012	72301	SECONDARY TEACHER	Certificated	T03	05	P	A	1.00	60,729	1.00	45,909
EDN100/AA	1/4/2012	74169	ELEM TEACHER	Certificated	T03	05	P	A	1.00	80,465	1.00	47,287
EDN100/AA	1/4/2012	602396	SECONDARY TEACHER	Certificated	T03	05	T	A			1.00	45,909
EDN100/AA	1/4/2012	600700	ELEM TEACHER	Certificated	T02	05	T	A			1.00	42,509
EDN100/AA	1/4/2012	66534	SECONDARY TEACHER	Certificated	T02	05	P	A	1.00	74,688	1.00	42,509
EDN100/AA	1/4/2012	66631	SECONDARY TEACHER	Certificated	T02	05	P	A	1.00	60,729	1.00	32,222
EDN100/BJ	1/4/2012	602353	SPECIAL SCH TEACHER	Certificated	T02	05	T	A			0.50	16,111
EDN100/AA	1/4/2012	65075	SECONDARY TEACHER	Certificated	T03	05	P	A	1.00	57,785	1.00	47,287
EDN100/AA	1/4/2012	602491	ELEM TEACHER	Certificated	T02	05	T	A			1.00	42,509
EDN100/AA	1/4/2012	67324	ELEM TEACHER	Certificated	T03	05	P	A	1.00	72,513	1.00	47,287
EDN100/AA	1/4/2012	68664	ELEM TEACHER	Certificated	T03	05	P	A	1.00	79,170	1.00	45,909
EDN100/AA	1/4/2012	60701	ELEM TEACHER	Certificated	T02	05	P	A	1.00	47,159	1.00	42,509
EDN100/AA	1/4/2012	61498	ELEM TEACHER	Certificated	T02	05	P	A	1.00	43,157	1.00	42,509
EDN100/AA	1/4/2012	60213	ELEM TEACHER	Certificated	T03	05	P	A	1.00	63,595	1.00	45,909
EDN150/FA	1/4/2012	63179	SPEC ED TEACHER	Certificated	T07	05	P	A	1.00	55,622	1.00	54,741
EDN100/AA	1/4/2012	69090	ELEM TEACHER	Certificated	T02	05	P	A	1.00	52,460	1.00	42,509
EDN100/AA	1/4/2012	64594	SECONDARY TEACHER	Certificated	T02	05	P	A	1.00	56,917	1.00	42,509
EDN100/AA	1/4/2012	802326	SCHOOL SECURITY ATTENDANT	N	SR07	03	T	A			0.75	9,599
EDN150/FA	1/4/2012	601233	SPEC ED TCHR/PRE-SCHOOL	Certificated	T02	05	T	A			1.00	42,509
EDN100/AA	1/4/2012	602516	ELEM TEACHER	Certificated	T02	05	T	A			1.00	42,509
EDN150/FA	1/4/2012	57541	EDUC ASST III	Y	SR12	03	T	A	0.75	19,599	0.75	18,773
EDN100/AA	1/4/2012	62033	SECONDARY TEACHER	Certificated	T02	05	P	A	1.00	68,351	1.00	32,222
EDN400/MD	1/4/2012	801942	CAFETERIA HELPER	N	BC02	01	T	A			0.50	16,614
EDN100/AA	1/4/2012	66252	ELEM TEACHER	Certificated	T03	05	P	A	1.00	64,482	1.00	45,909
EDN150/FA	1/4/2012	69214	SPEC ED TEACHER	Certificated	T02	05	T	A	1.00	49,448	1.00	42,509
EDN150/FA	1/4/2012	69868	SPEC ED TEACHER	Certificated	T02	05	P	A	1.00	43,157	1.00	42,509
EDN100/AA	1/5/2012	33223	CLERK TYPIST II	N	SR08	03	P	A	1.00	33,756	1.00	13,327
EDN100/AA	1/5/2012	59731	SCHOOL SECURITY ATTENDANT	N	SR07	03	T	A	0.50	10,722	0.50	6,399
EDN100/AA	1/5/2012	59822	SCHOOL SECURITY ATTENDANT	N	SR07	03	T	A	0.50	10,722	0.50	6,080
EDN100/AA	1/5/2012	66738	SECONDARY TEACHER	Certificated	T02	05	P	A	1.00	79,170	1.00	42,509
EDN400/MD	1/5/2012	28010	CAFETERIA HELPER	N	BC02	01	T	N	0.50	16,614	0.50	8,629
EDN150/FA	1/6/2012	76166	SPEC ED TCHR/PRE-SCHOOL	Certificated	T02	05	P	A	1.00	75,733	1.00	42,509
EDN100/AA	1/9/2012	801740	EDUC ASST II	Y	SR10	03	T	A			0.75	17,348
EDN150/FA	1/9/2012	74173	SPEC ED TEACHER	Certificated	T02	05	P	A	1.00	48,008	1.00	42,509
EDN100/AA	1/9/2012	60804	SECONDARY TEACHER	Certificated	T02	05	P	A	1.00	44,452	1.00	42,509
EDN150/FA	1/9/2012	75534	GEN EDUC/ARTICLE VI TCHR	Certificated	T03	05	T	A			1.00	45,909

Department of Education
New Hires

Table 16

<u>Prog ID/Org</u>	<u>New Hire Effective Date</u>	<u>Position Number</u>	<u>Position Title</u>	<u>Exempt (Y/N)</u>	<u>SR Level</u>	<u>BU Code</u>	<u>T/P</u>	<u>MOF</u>	<u>Budgeted FTE</u>	<u>Budgeted Salary</u>	<u>Actual FTE</u>	<u>Actual Salary</u>
EDN100/AA	1/9/2012	601253	SECONDARY TEACHER	Certificated	T03	05	T	A			1.00	45,909
EDN150/FA	1/9/2012	800397	EDUC ASST III	Y	SR12	03	T	A	1.00	26,131	1.00	25,030
EDN100/AA	1/9/2012	600804	SECONDARY TEACHER	Certificated	T03	05	T	A			1.00	45,909
EDN100/DB	1/9/2012	800128	EDUC ASST I	Y	SR08	03	T	N			1.00	13,327
EDN150/FA	1/9/2012	600157	SPEC ED TEACHER	Certificated	T02	05	T	A			1.00	32,222
EDN150/FA	1/9/2012	72159	SPEC ED TCHR/PRE-SCHOOL	Certificated	T01	05	P	A	1.00	58,959	1.00	29,662
EDN100/AA	1/9/2012	60558	SPEC ED TEACHER	Certificated	T02	05	T	A			1.00	42,509
EDN100/AA	1/9/2012	66033	ELEM TEACHER	Certificated	T03	05	P	A	1.00	62,450	0.50	22,955
EDN100/AA	1/9/2012	13951	CLERK TYPIST II	N	SR08	03	P	A	1.00	26,700	0.50	12,834
EDN150/FA	1/10/2012	69802	SPEC ED TEACHER	Certificated	T03	05	P	A	1.00	70,400	1.00	45,909
EDN150/YG	1/10/2012	59555	BEHAVIORAL HLTH SPCLT III	N	SR20	13	P	A	1.00	45,576	1.00	42,132
EDN100/AA	1/11/2012	63005	COUNSELOR	Certificated	T03	05	P	A	1.00	68,408	1.00	45,909
EDN100/AA	1/11/2012	602533	ELEM TEACHER	Certificated	T02	05	T	A			1.00	42,509
EDN100/AA	1/11/2012	69876	ELEM TEACHER	Certificated	T02	05	P	A	1.00	49,448	1.00	42,509
EDN100/AA	1/11/2012	602506	ELEM TEACHER	Certificated	T02	05	T	A			0.50	21,255
EDN100/AA	1/11/2012	69916	SECONDARY TEACHER	Certificated	T02	05	P	A	1.00	51,426	1.00	42,509
EDN150/FA	1/11/2012	801887	EDUC ASST III	Y	SR12	03	T	A			1.00	25,030
EDN100/AA	1/13/2012	802473	DP USER SUPPORT TECH I	N	SR13	03	T	A			1.00	16,211
EDN150/FA	1/13/2012	57141	EDUC ASST II	Y	SR10	03	T	A			1.00	23,130
EDN100/AA	1/13/2012	602540	ELEM TEACHER	Certificated	T02	05	T	A			0.50	21,255
EDN100/AA	1/13/2012	69555	SECONDARY TEACHER	Certificated	T02	05	T	A	1.00	51,426	1.00	32,222
EDN100/AA	1/13/2012	600211	ELEM TEACHER	Certificated	T02	05	T	A			1.00	42,509
EDN100/AA	1/13/2012	69261	ELEM TEACHER	Certificated	T02	05	P	A	1.00	45,785	1.00	42,509
EDN100/AA	1/17/2012	802207	EDUC ASST III	Y	SR12	03	T	A			0.88	21,901
EDN100/AA	1/17/2012	802227	EDUC ASST III	Y	SR12	03	T	A			0.75	18,773
EDN150/NB	1/17/2012	802452	EDUC ASST I	Y	SR08	03	T	N			1.00	13,327
EDN100/AA	1/17/2012	802190	SCHOOL SECURITY ATTENDANT	N	SR07	03	T	A			1.00	20,540
EDN100/AA	1/17/2012	54867	CLERK III	N	SR08	03	T	A			1.00	25,668
EDN100/AA	1/17/2012	65205	ELEM TEACHER	Certificated	T03	05	P	A	1.00	62,550	1.00	45,909
EDN100/AA	1/17/2012	54879	CLERK III	N	SR08	03	T	A	0.50	12,834	0.50	6,664
EDN100/AA	1/17/2012	23045	SCHOOL CUSTODIAN II	N	BC02	01	P	A	0.50	16,614	0.50	16,614
EDN150/FA	1/17/2012	64805	SPEC ED TEACHER	Certificated	T02	05	T	A	1.00	43,157	1.00	42,509
EDN150/FA	1/17/2012	602351	GEN EDUC/ARTICLE VI TCHR	Certificated	T02	05	T	A			1.00	42,509
EDN100/AA	1/17/2012	63240	SECONDARY TEACHER	Certificated	T02	05	P	A	1.00	68,351	1.00	42,509
EDN100/AA	1/17/2012	802323	EDUC ASST II	Y	SR10	03	T	A			1.00	23,130
EDN100/AA	1/17/2012	62152	ELEM TEACHER	Certificated	T02	05	P	A	1.00	60,729	1.00	42,509
EDN150/FA	1/17/2012	68196	SPEC ED TEACHER	Certificated	T03	05	P	A	1.00	48,008	1.00	47,287
EDN150/YC	1/17/2012	58631	BEHAVIORAL HLTH SPCLT III	N	SR20	13	P	A	1.00	45,576	1.00	42,132
EDN150/FA	1/17/2012	57415	EDUC ASST II	Y	SR10	03	P	A	0.75	19,599	0.75	17,348
EDN100/AA	1/17/2012	18132	SCHOOL CUSTODIAN II	N	BC02	01	P	A	0.50	16,614	0.50	8,629
EDN100/CB	1/17/2012	801024	PRGM SPCLT V	N	SR24	13	T	W			1.00	51,312
EDN150/FA	1/17/2012	800197	EDUC ASST III	Y	SR12	03	P	A	1.00	26,131	1.00	25,030
EDN200/GN	1/17/2012	29998	BILINGUAL/BICULTURAL S/H ASST	Y	SR11	03	T	A	1.00	39,480	0.50	14,418
EDN400/OC	1/17/2012	3869	HEAVY TRUCK DRIVER	N	BC07	01	P	A	1.00	39,972	1.00	39,972
EDN100/DB	1/17/2012	23101	ACCOUNT CLERK III	N	SR11	03	T	N			1.00	28,836
EDN100/AA	1/17/2012	29373	SCHOOL HEALTH AIDE	N	SR09	03	P	A	1.00	21,231	1.00	18,078
EDN100/CB	1/17/2012	59992	PRGM SPCLT V	N	SR24	13	T	W			1.00	51,312

Department of Education
New Hires

Table 16

<u>Prog ID/Org</u>	<u>New Hire Effective Date</u>	<u>Position Number</u>	<u>Position Title</u>	<u>Exempt (Y/N)</u>	<u>SR Level</u>	<u>BU Code</u>	<u>T/P</u>	<u>MOF</u>	<u>Budgeted FTE</u>	<u>Budgeted Salary</u>	<u>Actual FTE</u>	<u>Actual Salary</u>
EDN100/AA	1/18/2012	62693	COUNSELOR	Certificated	T03	05	P	A	1.00	58,959	1.00	45,909
EDN300/KO	1/18/2012	58577	PERSONNEL CLERK IV	N	SR11	03	P	A	1.00	32,424	1.00	28,836
EDN100/AA	1/18/2012	66805	SECONDARY TEACHER	Certificated	T02	05	P	A	1.00	35,329	1.00	32,222
EDN150/FA	1/19/2012	800062	EDUC ASST III	Y	SR12	03	T	A	1.00	29,368	1.00	25,030
EDN100/AA	1/20/2012	9764	CLERK TYPIST II	N	SR08	03	P	A	1.00	27,756	1.00	13,327
EDN150/FA	1/20/2012	74909	SPEC ED TEACHER	Certificated	T03	05	P	A	1.00	46,609	1.00	45,909
EDN100/AA	1/23/2012	802303	SCHOOL CUSTODIAN II	N	BC02	01	P	A			0.50	8,629
EDN150/FA	1/23/2012	76046	SPEC ED TEACHER	Certificated	T02	05	P	A	1.00	49,448	1.00	32,222
EDN100/AA	1/23/2012	68018	SECONDARY TEACHER	Certificated	T02	05	P	A	1.00	79,170	1.00	42,509
EDN150/FA	1/23/2012	801335	EDUC ASST II	Y	SR10	03	T	A	1.00	26,131	0.75	17,348
EDN100/AA	1/23/2012	62268	SECONDARY TEACHER	Certificated	T02	05	P	A	1.00	74,688	1.00	42,509
EDN100/AA	1/23/2012	73790	COUNSELOR	Certificated	T03	05	T	A	1.00	49,448	1.00	45,909
EDN100/AA	1/23/2012	602468	ELEM TEACHER	Certificated	T02	05	T	A			1.00	42,509
EDN100/AA	1/24/2012	802327	EDUC ASST III	Y	SR12	03	P	A			1.00	25,030
EDN100/AA	1/24/2012	601468	LIBRARIAN	Certificated	T03	05	T	A			0.50	23,643
EDN100/AA	1/24/2012	60542	ELEM TEACHER	Certificated	T03	05	P	A	1.00	60,004	1.00	45,909
EDN150/FA	1/25/2012	600005	SPEC ED TEACHER	Certificated	T02	05	T	A			1.00	42,509
EDN100/AA	1/25/2012	60556	ELEM TEACHER	Certificated	T02	05	P	A	1.00	63,959	1.00	42,509
EDN150/FA	1/25/2012	65760	SPEC ED TEACHER	Certificated	T02	05	P	A	1.00	47,159	1.00	32,222
EDN150/FA	1/26/2012	69582	SPEC ED TEACHER	Certificated	T02	05	P	A	1.00	70,400	1.00	32,222
EDN100/AA	1/30/2012	64764	SECONDARY TEACHER	Certificated	T03	05	P	A	1.00	40,567	1.00	45,909
EDN100/AA	1/30/2012	600436	ELEM TEACHER	Certificated	T02	05	T	A			1.00	42,509
EDN100/AA	1/30/2012	66662	ELEM TEACHER	Certificated	T02	05	P	A	1.00	58,959	1.00	42,509
EDN150/YC	1/30/2012	58332	BEHAVIORAL HLTH SPCLT III	N	SR20	13	T	A	0.50	24,666	0.50	21,066
EDN100/AA	1/30/2012	54884	CLERK III	N	SR08	03	T	A	1.00	25,668	1.00	25,668
EDN400/OC	1/30/2012	43544	BUILDING MAINTENANCE WORKER I	N	BC09	01	P	A	1.00	44,544	1.00	23,134
EDN150/YC	1/30/2012	58650	BEHAVIORAL HLTH SPCLT III	N	SR20	13	T	A	1.00	49,332	1.00	21,881
EDN400/MD	1/30/2012	802013	CAFETERIA HELPER	N	BC02	01	T	A			0.50	16,614
EDN150/YG	2/1/2012	68677	DIST OFF TCHR	Certificated	T03	05	P	A	1.00	68,351	1.00	47,287
EDN150/YG	2/1/2012	801881	EDUC ASST III	Y	SR12	03	T	A			1.00	25,030
EDN150/YG	2/1/2012	801882	EDUC ASST III	Y	SR12	03	T	A			1.00	25,030
EDN150/FA	2/1/2012	71499	SPEC ED TCHR/PRE-SCHOOL	Certificated	T02	05	P	A	1.00	58,959	1.00	32,222
EDN100/AA	2/1/2012	29432	SCHOOL HEALTH AIDE	N	SR09	03	P	A	1.00	18,873	1.00	18,078
EDN100/AA	2/1/2012	16175	SCHOOL CUSTODIAN II	N	BC02	01	P	A	1.00	33,228	1.00	33,228
EDN100/AA	2/1/2012	802306	EDUC ASST II	Y	SR10	03	T	A			1.00	23,130
EDN100/AA	2/1/2012	55138	EDUC ASST III	Y	SR12	03	P	A	0.50	13,066	0.50	12,515
EDN100/AA	2/1/2012	63524	SECONDARY TEACHER	Certificated	T03	05	P	A	1.00	58,959	1.00	45,909
EDN400/MD	2/1/2012	46015	CAFETERIA HELPER	N	BC02	01	T	N	0.50	16,614	0.50	16,614
EDN200/GN	2/1/2012	802393	SCHOOL CUSTODIAN II	N	BC02	01	T	A			0.50	8,629
EDN100/AA	2/1/2012	14715	CLERK TYPIST II	N	SR08	03	P	A	0.50	17,532	0.50	6,664
EDN100/AA	2/1/2012	601362	ELEM TEACHER	Certificated	T02	05	T	A			1.00	42,509
EDN400/MD	2/1/2012	28140	CAFETERIA HELPER	N	BC02	01	T	N	0.50	16,614	0.50	16,614
EDN150/YG	2/1/2012	800272	EDUC ASST III	Y	SR12	03	P	A	1.00	26,131	1.00	25,030
EDN150/FA	2/1/2012	801468	EDUC ASST II	Y	SR10	03	T	A	1.00	26,131	1.00	23,130
EDN100/AA	2/1/2012	56444	CLERK TYPIST II	N	SR08	03	P	A	0.50	12,834	1.00	13,327
EDN100/AA	2/1/2012	802410	EDUC ASST I	Y	SR08	03	T	A			0.50	10,695
EDN100/AA	2/1/2012	73053	COUNSELOR	Certificated	T02	05	P	A	1.00	48,008	1.00	32,222

<u>Prog ID/Org</u>	<u>New Hire Effective Date</u>	<u>Position Number</u>	<u>Position Title</u>	<u>Exempt (Y/N)</u>	<u>SR Level</u>	<u>BU Code</u>	<u>T/P</u>	<u>MOF</u>	<u>Budgeted FTE</u>	<u>Budgeted Salary</u>	<u>Actual FTE</u>	<u>Actual Salary</u>
EDN150/FA	2/1/2012	63913	GEN EDUC/ARTICLE VI TCHR	Certificated	T02	05	P	A	1.00	43,157	1.00	42,509
EDN150/YG	2/1/2012	801876	EDUC ASST II	Y	SR10	03	T	A			1.00	23,130
EDN100/AA	2/1/2012	801838	CLERK TYPIST II	N	SR08	03	T	A			1.00	25,668
EDN150/YC	2/1/2012	58349	BEHAVIORAL HLTH SPCLT III	N	SR20	13	P	A	1.00	45,576	1.00	42,132
EDN150/NB	2/1/2012	602444	12-MO DIST OFF TCHR	Certificated	T03	05	T	N			1.00	45,909
EDN150/YG	2/1/2012	801854	EDUC ASST III	Y	SR12	03	T	A			1.00	25,030
EDN100/AA	2/1/2012	59989	CLERK II	N	SR06	03	T	A			1.00	12,301
EDN150/NB	2/1/2012	38737	CLERK TYPIST II	N	SR08	03	T	N			1.00	25,668
EDN100/AA	2/1/2012	12126	CLERK TYPIST II	N	SR08	03	P	A	1.00	26,700	1.00	25,668
EDN100/AA	2/1/2012	802166	CLERK TYPIST II	N	SR08	03	T	A			0.50	12,834
EDN150/FA	2/1/2012	52733	EDUC ASST III	Y	SR12	03	P	A	1.00	30,506	0.75	18,773
EDN400/OC	2/1/2012	10127	SECRETARY IV	N	SR18	03	P	A	1.00	58,440	1.00	37,968
EDN150/SA	2/1/2012	33173	SPEECH PATHOLOGIST IV	Y	SR22	13	P	A	1.00	69,305	1.00	45,576
EDN100/AA	2/2/2012	801961	EDUC ASST III	Y	SR12	03	T	A			1.00	25,030
EDN100/AA	2/2/2012	16495	SCHOOL CUSTODIAN II	N	BC02	01	P	A	1.00	33,228	0.50	16,614
EDN150/FA	2/2/2012	64291	GEN EDUC/ARTICLE VI TCHR	Certificated	T02	05	P	A			1.00	42,509
EDN100/AA	2/3/2012	56818	CLERK TYPIST II	N	SR08	03	P	A	1.00	28,836	0.50	6,664
EDN150/NB	2/3/2012	600606	DIST OFF TCHR	Certificated	T02	05	T	N			1.00	32,222
EDN100/AA	2/6/2012	19030	SCHOOL CUSTODIAN II	N	BC02	01	P	A	0.50	16,614	0.50	16,614
EDN100/AA	2/6/2012	802478	DP USER SUPPORT TECH II	N	SR15	03	T	A			1.00	17,528
EDN150/FA	2/6/2012	56773	EDUC ASST III	Y	SR12	03	T	A	1.00	26,131	1.00	25,030
EDN400/MD	2/6/2012	58619	CAFETERIA HELPER	N	BC02	01	T	N			0.50	8,629
EDN150/FA	2/6/2012	602481	SPEC ED TEACHER	Certificated	T02	05	T	A			1.00	42,509
EDN400/MD	2/6/2012	47321	CAFETERIA HELPER	N	BC02	01	T	N			0.50	16,614
EDN150/FA	2/6/2012	69843	SPEC ED TEACHER	Certificated	T02	05	P	A	1.00	55,622	1.00	42,509
EDN100/AA	2/6/2012	602695	ELEM TEACHER	Certificated	T02	05	T	A			1.00	42,509
EDN100/AA	2/6/2012	73433	ELEM TEACHER	Certificated	T02	05	P	A	1.00	50,931	1.00	42,509
EDN150/FA	2/6/2012	600989	SPEC ED TEACHER	Certificated	T03	05	T	A			1.00	45,909
EDN150/FA	2/6/2012	73308	SPEC ED TEACHER	Certificated	T02	05	P	A	1.00	46,609	0.50	21,255
EDN100/AA	2/6/2012	600866	ELEM TEACHER	Certificated	T02	05	T	A			1.00	42,509
EDN400/MD	2/6/2012	45866	CAFETERIA HELPER	N	BC02	01	T	N	0.50	16,614	0.50	16,614
EDN100/AA	2/6/2012	42553	SCHOOL CUSTODIAN II	N	BC02	01	P	A	0.50	16,614	0.50	16,614
EDN150/FA	2/7/2012	66615	SPEC ED TEACHER	Certificated	T02	05	T	A	1.00	43,157	1.00	32,222
EDN100/AA	2/7/2012	48420	CLERK TYPIST II	N	SR08	03	P	A	0.50	16,212	0.50	12,834
EDN100/AA	2/8/2012	31268	SCHOOL CUSTODIAN II	N	BC02	01	P	A	0.50	16,614	0.50	16,614
EDN100/AA	2/8/2012	600281	COUNSELOR	Certificated	T03	05	T	A			1.00	45,909
EDN150/YC	2/9/2012	58377	BEHAVIORAL HLTH SPCLT IV	N	SR22	13	P	A	1.00	57,708	1.00	49,332
EDN400/MD	2/13/2012	9418	SCHOOL COOK II	N	BC06	01	P	A			1.00	38,436
EDN100/AA	2/13/2012	59760	CLERK TYPIST II	N	SR08	03	T	A			0.50	12,834
EDN100/AA	2/13/2012	68447	ELEM TEACHER	Certificated	T03	05	P	A	1.00	60,662	1.00	45,909
EDN100/AA	2/13/2012	66863	SECONDARY TEACHER	Certificated	T02	05	P	A	1.00	46,609	1.00	42,509
EDN150/SA	2/13/2012	30935	COMMUNICATION AIDE	Y	SR12	03	P	A	1.00	28,209	1.00	25,030
EDN150/FA	2/14/2012	800491	EDUC ASST III	Y	SR12	03	T	A	1.00	27,154	1.00	25,030
EDN100/AA	2/14/2012	62369	SECONDARY TEACHER	Certificated	T02	05	P	A	1.00	53,483	1.00	42,509
EDN100/AA	2/15/2012	74071	ELEM TEACHER	Certificated	T02	05	P	A	1.00	58,959	1.00	42,509
EDN100/AA	2/15/2012	61379	ELEM TEACHER	Certificated	T02	05	P	A	1.00	49,928	1.00	42,509
EDN400/MD	2/16/2012	22824	CAFETERIA HELPER	N	BC02	01	P	A			0.50	8,629

Department of Education
New Hires

Table 16

<u>Prog ID/Org</u>	<u>New Hire Effective Date</u>	<u>Position Number</u>	<u>Position Title</u>	<u>Exempt (Y/N)</u>	<u>SR Level</u>	<u>BU Code</u>	<u>T/P</u>	<u>MOF</u>	<u>Budgeted FTE</u>	<u>Budgeted Salary</u>	<u>Actual FTE</u>	<u>Actual Salary</u>
EDN150/FA	2/16/2012	46091	EDUC ASST III	Y	SR12	03	P	A	1.00	34,347	1.00	25,030
EDN500/WA	2/16/2012	802397	CLERK TYPIST II	N	SR08	03	T	W			0.50	12,834
EDN100/AA	2/16/2012	30595	SCHOOL SECURITY ATTENDANT	N	SR07	03	P	A	1.00	21,444	1.00	12,798
EDN100/AA	2/16/2012	801535	CLERK TYPIST II	N	SR08	03	P	A			1.00	13,327
EDN100/AA	2/16/2012	69458	ELEM TEACHER	Certificated	T02	05	P	A	1.00	74,688	1.00	43,785
EDN100/AA	2/16/2012	45221	SCHOOL CUSTODIAN II	N	BC02	01	P	A	0.50	16,614	0.50	16,614
EDN100/AA	2/16/2012	801556	LIBRARY ASSISTANT II	N	SR05	03	T	A			1.00	22,776
EDN150/FA	2/16/2012	56685	EDUC ASST I	Y	SR08	03	P	A	0.75	21,157	0.75	9,995
EDN150/FA	2/16/2012	800124	EDUC ASST II	Y	SR10	03	T	A	0.75	19,599	0.75	17,348
EDN300/KF	2/16/2012	69290	FISCAL SPECIALIST II	Certificated	E07	06	P	A	1.00	78,146	1.00	77,069
EDN200/GN	2/16/2012	5061	CLERK TYPIST II	N	SR08	03	P	A	1.00	30,036	1.00	25,668
EDN100/AA	2/17/2012	29434	SCHOOL HEALTH AIDE	N	SR09	03	P	A	1.00	24,786	1.00	18,078
EDN100/AA	2/17/2012	66475	ELEM TEACHER	Certificated	T03	05	P	A	1.00	60,729	1.00	47,287
EDN100/AA	2/21/2012	64352	SECONDARY TEACHER	Certificated	T03	05	P	A	1.00	46,609	1.00	45,909
EDN150/YG	2/21/2012	801381	CLERK TYPIST II	N	SR08	03	P	A	1.00	25,668	1.00	13,327
EDN100/AA	2/21/2012	59773	CLERK II	N	SR06	03	T	A	0.50	11,844	0.50	6,151
EDN150/FA	2/21/2012	62415	SPEC ED TEACHER	Certificated	T02	05	P	A	1.00	43,157	1.00	42,509
EDN150/FA	2/21/2012	802408	EDUC ASST III	Y	SR12	03	P	A			0.75	18,773
EDN100/AA	2/21/2012	601631	SECONDARY TEACHER	Certificated	T03	05	T	A			1.00	45,909
EDN150/YC	2/21/2012	59733	CLINICAL PSYCHOLOGIST V	N	SR24	13	T	A	1.00	66,024	1.00	51,312
EDN150/YC	2/21/2012	58093	SOCIAL WORKER IV	N	SR22	13	P	A	1.00	49,332	1.00	23,663
EDN150/FB	2/22/2012	802304	SCHOOL SECURITY ATTENDANT	N	SR07	03	P	A			1.00	20,540
EDN100/AA	2/22/2012	67006	SECONDARY TEACHER	Certificated	T03	05	P	A	1.00	45,785	1.00	45,909
EDN150/NB	2/22/2012	79401	DIST OFF TCHR	Certificated	T02	05	T	N			1.00	42,509
EDN150/FA	2/24/2012	66439	GEN EDUC/ARTICLE VI TCHR	Certificated	T02	05	P	A	1.00	51,426	1.00	42,509
EDN150/FA	2/24/2012	65121	SPEC ED TEACHER	Certificated	T02	05	P	A	1.00	45,785	1.00	43,785
EDN150/FA	2/24/2012	75582	SPEC ED TCHR/PRE-SCHOOL	Certificated	T03	05	T	A	1.00	32,713	1.00	45,909
EDN100/AA	2/24/2012	69195	SECONDARY TEACHER	Certificated	T03	05	P	A	1.00	43,157	1.00	45,909
EDN150/FA	2/24/2012	73809	SPEC ED TEACHER	Certificated	T02	05	P	A	1.00	52,721	1.00	42,509
EDN150/FA	2/24/2012	66221	SPEC ED TEACHER	Certificated	T03	05	P	A	1.00	49,448	1.00	45,909
EDN100/AA	2/24/2012	73935	SECONDARY TEACHER	Certificated	T02	05	T	A	1.00	79,170	1.00	32,222
EDN100/AA	2/24/2012	68079	ELEM TEACHER	Certificated	T03	05	P	A	1.00	54,558	1.00	45,909
EDN150/FA	2/24/2012	52676	EDUC ASST II	Y	SR10	03	P	A	0.75	19,599	0.75	17,348
EDN150/NB	2/24/2012	802469	CLINICAL PSYCHOLOGIST VI	N	SR26	13	T	N			1.00	28,814
EDN150/FA	2/27/2012	54721	EDUC ASST III	Y	SR12	03	P	A	0.50	14,684	0.50	12,515
EDN100/AA	2/27/2012	802427	CLERK I	N	SR04	03	T	A			0.50	10,974
EDN100/CB	2/27/2012	50395	PERSONNEL CLERK IV	N	SR11	03	P	A	1.00	30,036	1.00	14,969
EDN150/FA	2/27/2012	56688	EDUC ASST II	Y	SR10	03	T	A	0.75	19,599	0.75	17,348
EDN100/AA	3/1/2012	16376	SCHOOL CUSTODIAN II	N	BC02	01	P	A	1.00	33,228	0.50	16,614
EDN150/YC	3/1/2012	58334	BEHAVIORAL HLTH SPCLT III	N	SR20	13	P	A	1.00	45,576	1.00	21,881
EDN100/AA	3/1/2012	30594	SCHOOL SECURITY ATTENDANT	N	SR07	03	P	A	1.00	23,229	1.00	12,798
EDN100/AA	3/1/2012	802205	EDUC ASST III	Y	SR12	03	T	A			0.88	21,901
EDN150/YG	3/1/2012	801848	EDUC ASST III	Y	SR12	03	T	A			1.00	25,030
EDN150/NB	3/1/2012	802449	EDUC ASST II	Y	SR10	03	T	N			1.00	23,130
EDN100/AA	3/1/2012	801551	EDUC ASST II	Y	SR10	03	T	A			1.00	23,130
EDN100/AA	3/1/2012	801580	OFFICE ASSISTANT III	N	SR08	03	T	A			1.00	25,668
EDN400/MD	3/1/2012	801917	CAFETERIA HELPER	N	BC02	01	T	A			0.50	16,614

Department of Education
New Hires

Table 16

<u>Prog ID/Org</u>	<u>New Hire Effective Date</u>	<u>Position Number</u>	<u>Position Title</u>	<u>Exempt (Y/N)</u>	<u>SR Level</u>	<u>BU Code</u>	<u>T/P</u>	<u>MOF</u>	<u>Budgeted FTE</u>	<u>Budgeted Salary</u>	<u>Actual FTE</u>	<u>Actual Salary</u>
EDN100/AA	3/1/2012	39925	OFFICE ASSISTANT III	N	SR08	03	P	A	1.00	30,036	1.00	13,327
EDN100/AA	3/1/2012	57674	OFFICE ASSISTANT III	N	SR08	03	P	A	0.50	14,418	0.50	12,834
EDN400/MD	3/1/2012	54661	CAFETERIA HELPER	N	BC02	01	T	N			0.50	16,614
EDN100/AA	3/1/2012	43092	OFFICE ASSISTANT III	N	SR08	03	P	A	1.00	28,836	1.00	30,036
EDN150/YC	3/1/2012	59732	CLINICAL PSYCHOLOGIST VI	N	SR26	13	T	A	1.00	74,160	1.00	55,500
EDN100/AA	3/1/2012	801637	DP USER SUPPORT TECH I	N	SR13	03	P	A			1.00	16,211
EDN150/FA	3/5/2012	57330	EDUC ASST II	Y	SR10	03	T	A	0.75	19,599	0.75	17,348
EDN150/NB	3/5/2012	800065	EDUC ASST II	Y	SR10	03	T	N			1.00	23,130
EDN400/OC	3/5/2012	43553	BUILDING MAINTENANCE WORKER I	N	BC09	01	P	A	1.00	44,544	1.00	23,134
EDN100/AA	3/5/2012	801077	OFFICE ASSISTANT III	N	SR08	03	T	A			1.00	25,668
EDN400/MD	3/6/2012	22062	FOOD SERVICES DRIVER	N	BC03	01	T	N	0.50	17,082	0.50	17,082
EDN150/FA	3/7/2012	52942	EDUC ASST II	Y	SR10	03	P	A	0.75	19,599	0.75	17,348
EDN400/OC	3/7/2012	33426	PLUMBER I	N	BC10	01	P	A	1.00	49,320	1.00	46,236
EDN150/YC	3/7/2012	800423	SCHOOL PSYCHOLOGIST	Y	SR24	13	P	A	1.00	58,716	1.00	51,312
EDN150/FA	3/8/2012	801418	EDUC ASST III	Y	SR12	03	T	A			1.00	25,030
EDN150/FA	3/8/2012	57050	EDUC ASST III	Y	SR12	03	T	A	1.00	28,209	1.00	25,030
EDN400/MD	3/12/2012	49640	CAFETERIA HELPER	N	BC02	01	T	N			0.50	16,614
EDN100/AA	3/12/2012	800710	OFFICE ASSISTANT III	N	SR08	03	P	A	1.00	26,700	1.00	26,700
EDN400/MB	3/12/2012	801721	PRGM SPCLT IV	N	SR22	13	T	N			1.00	23,663
EDN150/YG	3/15/2012	801817	SOCIAL WORKER IV	N	SR22	13	P	A			1.00	23,663
EDN100/AA	3/16/2012	45120	OFFICE ASSISTANT III	N	SR08	03	P	A	1.00	39,480	1.00	31,212
EDN100/AA	3/16/2012	58252	OFFICE ASSISTANT II	N	SR06	03	P	A	1.00	23,688	1.00	23,688
EDN300/JA	3/16/2012	73064	TELECOMM NETWORK SPEC II	Certificated	E07	06	P	A	1.00	77,069	1.00	80,350
EDN100/AA	3/19/2012	802208	EDUC ASST II	Y	SR10	03	T	A			0.75	17,348
EDN150/YG	3/19/2012	802282	EDUC ASST I	Y	SR08	03	T	A			1.00	21,390
EDN150/FA	3/19/2012	55342	EDUC ASST I	Y	SR08	03	P	A	0.50	13,577	0.50	6,664
EDN100/DB	3/19/2012	800131	EDUC ASST I	Y	SR08	03	T	N			1.00	13,327
EDN100/AA	3/19/2012	802206	EDUC ASST III	Y	SR12	03	T	A			0.88	21,901
EDN150/FA	3/19/2012	57140	EDUC ASST I	Y	SR08	03	T	A			1.00	21,390
EDN400/MB	3/19/2012	801313	OFFICE ASSISTANT III	N	SR08	03	T	N			1.00	13,327
EDN150/SA	3/19/2012	30436	SPEECH PATHOLOGIST II	Y	SR18	13	P	A	1.00	69,305	1.00	20,239
EDN150/YC	3/19/2012	58645	BEHAVIORAL HLTH SPCLT III	N	SR20	13	T	A	1.00	47,412	1.00	21,881
EDN100/AA	3/19/2012	30669	SCHOOL SECURITY ATTENDANT	N	SR07	03	P	A	1.00	23,229	1.00	20,540
EDN150/YC	3/19/2012	802219	EDUC ASST I	Y	SR08	03	T	A			1.00	13,327
EDN400/MB	3/20/2012	58713	SECRETARY III	N	SR16	03	T	N	1.00	37,968	1.00	35,064
EDN150/YG	3/21/2012	801669	BEHAVIORAL HLTH SPCLT III	N	SR20	13	T	A			1.00	42,132
EDN150/FA	3/21/2012	58812	EDUC ASST I	Y	SR08	03	T	A	1.00	28,209	1.00	21,390
EDN150/YG	3/21/2012	801883	EDUC ASST III	Y	SR12	03	T	A			1.00	25,030
EDN150/FA	3/21/2012	802337	EDUC ASST III	Y	SR12	03	P	A			1.00	25,030
EDN400/MD	3/22/2012	45999	CAFETERIA HELPER	N	BC02	01	P	A			0.50	16,614
EDN100/AA	3/22/2012	55850	EDUC ASST II	Y	SR10	03	P	A	0.50	13,066	0.50	11,565
EDN150/FA	3/27/2012	57669	EDUC ASST II	Y	SR10	03	T	A	1.00	30,506	0.75	17,348
EDN150/YG	3/27/2012	802379	EDUC ASST II	Y	SR10	03	T	A			1.00	23,130
EDN100/AA	3/27/2012	29303	SCHOOL HEALTH AIDE	N	SR09	03	P	A	1.00	23,861	1.00	18,078
EDN150/YC	3/28/2012	58653	BEHAVIORAL HLTH SPCLT III	N	SR20	13	P	A	1.00	47,412	1.00	42,132
EDN100/DB	3/30/2012	800130	EDUC ASST I	Y	SR08	03	T	N			1.00	13,327
EDN400/MD	3/30/2012	50822	CAFETERIA HELPER	N	BC02	01	T	N			0.50	16,614

Prog ID/Org	New Hire Effective Date	Position Number	Position Title	Exempt (Y/N)	SR Level	BU Code	T/P	MOF	Budgeted FTE	Budgeted Salary	Actual FTE	Actual Salary
EDN400/MD	4/2/2012	801948	CAFETERIA HELPER	N	BC02	01	T	A			0.50	16,614
EDN100/AA	4/2/2012	41902	OFFICE ASSISTANT III	N	SR08	03	P	A	0.50	12,834	0.50	12,834
EDN150/NB	4/2/2012	800362	EDUC ASST II	Y	SR10	03	T	N			1.00	23,130
EDN400/MD	4/2/2012	801488	CAFETERIA HELPER	N	BC02	01	T	A	0.50	16,614	0.50	16,614
EDN150/FA	4/2/2012	57356	EDUC ASST II	Y	SR10	03	T	A	0.75	19,599	0.75	17,348
EDN100/AA	4/2/2012	16673	SCHOOL CUSTODIAN II	N	BC02	01	P	A	1.00	33,228	1.00	33,228
EDN300/UA	4/2/2012	30542	AUTOMATED SYSTS EQUIP TECH I	N	BC14	01	P	A	1.00	53,532	1.00	27,799
EDN100/AA	4/3/2012	43993	EDUC ASST I	Y	SR08	03	P	A	1.00	29,368	1.00	13,327
EDN150/YC	4/3/2012	58331	BEHAVIORAL HLTH SPCLT III	N	SR20	13	P	A	1.00	47,412	1.00	21,881
EDN100/AA	4/3/2012	18818	SCHOOL CUSTODIAN II	N	BC02	01	P	A	0.50	16,614	0.50	8,629
EDN100/AA	4/3/2012	802512	EDUC ASST I	Y	SR08	03	T	A			1.00	13,327
EDN100/AA	4/3/2012	802517	OFFICE ASSISTANT II	N	SR06	03	T	A			1.00	12,301
EDN150/SA	4/3/2012	28987	PHYSICAL THERAPIST IV	N	SR22	13	P	A	1.00	61,812	1.00	45,576
EDN150/YG	4/3/2012	801073	EDUC ASST I	Y	SR08	03	P	A			1.00	13,327
EDN300/KD	4/3/2012	59880	AUDITOR V	N	SR24	13	P	A	1.00	60,024	1.00	26,644
EDN150/SA	4/9/2012	56374	SPEECH PATHOLOGIST IV	Y	SR22	13	P	A	1.00	58,563	1.00	23,663
EDN100/AA	4/9/2012	47088	SCHOOL CUSTODIAN II	N	BC02	01	P	A	0.50	16,614	0.50	16,614
EDN100/AA	4/11/2012	59843	LIBRARY ASSISTANT III	N	SR07	03	P	A	1.00	26,700	1.00	12,798
EDN100/AA	4/16/2012	802174	SCHOOL SECURITY ATTENDANT	N	SR07	03	T	A			1.00	20,540
EDN400/MD	4/16/2012	59065	CAFETERIA HELPER	N	BC02	01	T	N	0.50	16,614	0.50	16,614
EDN200/GN	4/16/2012	59863	OFFICE ASSISTANT III	N	SR08	03	T	A			1.00	13,327
EDN150/YG	4/16/2012	800791	EDUC ASST II	Y	SR10	03	P	A	1.00	26,131	1.00	23,130
EDN300/KO	4/16/2012	59128	PERSONNEL CLERK V	N	SR13	03	P	A	1.00	37,968	1.00	16,211
EDN150/FA	4/17/2012	58769	EDUC ASST II	Y	SR10	03	P	A	0.50	13,066	0.50	11,565
EDN150/NB	4/18/2012	800627	EDUC ASST III	Y	SR12	03	T	N			1.00	25,030
EDN300/KO	4/20/2012	58220	PERSONNEL CLERK V	N	SR13	03	P	A	1.00	35,064	1.00	16,211
EDN150/FA	4/23/2012	58055	EDUC ASST II	Y	SR10	03	P	A	0.50	13,066	0.50	11,565
EDN150/SA	4/23/2012	30482	COMMUNICATION AIDE	Y	SR12	03	P	A	1.00	31,769	1.00	25,030
EDN100/AA	4/27/2012	802394	OFFICE ASSISTANT III	N	SR08	03	T	A			0.50	12,834
EDN150/YC	4/30/2012	802214	EDUC ASST II	Y	SR10	03	T	A			1.00	23,130
EDN100/AA	4/30/2012	38891	OFFICE ASSISTANT III	N	SR08	03	P	A	0.50	12,834	0.50	6,664
EDN100/AA	4/30/2012	802197	DP USER SUPPORT TECH II	N	SR15	03	T	A			1.00	17,528
EDN150/FA	4/30/2012	57349	EDUC ASST III	Y	SR12	03	T	A	0.75	19,599	0.75	18,773
EDN100/DB	5/1/2012	802482	DISTRICT PCNC ASSISTANT	N	SR15	03	T	N			1.00	17,528
EDN100/AA	5/1/2012	56798	OFFICE ASSISTANT III	N	SR08	03	P	A	0.50	13,878	0.50	12,834
EDN300/KO	5/1/2012	8911	SECRETARY II	N	SR14	03	P	A	1.00	35,064	1.00	32,424
EDN100/AA	5/1/2012	16484	SCHOOL CUSTODIAN II	N	BC02	01	P	A	1.00	33,228	1.00	33,228
EDN150/YG	5/1/2012	802287	EDUC ASST II	Y	SR10	03	T	A			1.00	23,130
EDN100/AA	5/1/2012	55366	OFFICE ASSISTANT III	N	SR08	03	P	A	1.00	27,756	1.00	13,327
EDN400/MD	5/1/2012	2091	SCHOOL FOOD SERVICES MGR I	N	WF06	02	P	A	1.00	46,544	1.00	39,972
EDN300/KD	5/1/2012	802030	LITIGATION COORDINATOR	N	EM03	13	P	A	1.00	-	1.00	65,088
EDN200/GN	5/1/2012	802393	SCHOOL CUSTODIAN II	N	BC02	01	T	A			0.50	8,629
EDN300/KO	5/1/2012	45186	PERSONNEL MGMT SPECIALIST V	N	SR24	13	P	A	1.00	57,708	1.00	26,644
EDN150/YG	5/2/2012	801199	BEHAVIORAL HLTH SPCLT III	N	SR20	13	P	A	1.00	45,576	1.00	42,132
EDN150/YC	5/2/2012	58292	CLINICAL PSYCHOLOGIST VIII	N	SR30	13	T	A	1.00	93,780	1.00	67,488
EDN400/MD	5/2/2012	800971	SCHOOL COOK I	N	BC04	01	P	A			1.00	35,544
EDN400/MD	5/7/2012	802299	CAFETERIA HELPER	N	BC02	01	T	N			0.50	16,614

<u>Prog ID/Org</u>	<u>New Hire Effective Date</u>	<u>Position Number</u>	<u>Position Title</u>	<u>Exempt (Y/N)</u>	<u>SR Level</u>	<u>BU Code</u>	<u>T/P</u>	<u>MOF</u>	<u>Budgeted FTE</u>	<u>Budgeted Salary</u>	<u>Actual FTE</u>	<u>Actual Salary</u>
EDN150/SA	5/7/2012	28988	OCC THERAPIST IV	N	SR22	13	P	A	1.00	60,372	1.00	45,576
EDN100/AA	5/7/2012	801801	DP USER SUPPORT TECH II	N	SR15	03	T	A			0.50	8,764
EDN100/AA	5/14/2012	802253	DP USER SUPPORT TECH II	N	SR15	03	T	A			1.00	17,528
EDN150/YG	5/14/2012	800274	EDUC ASST III	Y	SR12	03	P	A	1.00	26,131	1.00	25,030
EDN150/SA	5/14/2012	30439	SPEECH PATHOLOGIST IV	Y	SR22	13	P	A	1.00	69,305	1.00	23,663
EDN100/DB	5/14/2012	59583	OFFICE ASSISTANT II	N	SR06	03	T	N			1.00	12,301
EDN100/AA	5/16/2012	59745	ACCOUNT CLERK II	N	SR08	03	T	A			1.00	25,668
EDN100/AA	5/16/2012	801060	OFFICE ASSISTANT III	N	SR08	03	T	A	1.00	25,668	1.00	13,327
EDN100/AA	5/16/2012	800735	SCHOOL CUSTODIAN II	N	BC02	01	P	A			1.00	17,258
EDN100/AA	5/16/2012	16454	SCHOOL CUSTODIAN II	N	BC02	01	P	A	1.00	33,228	1.00	33,228
EDN300/UA	5/16/2012	801044	DATA PROCSSG SYSTS ANAL II	N	SR18	13	T	A			1.00	38,988
EDN150/FA	5/17/2012	37289	EDUC ASST III	Y	SR12	03	P	A	1.00	28,209	1.00	25,030
EDN100/AA	5/17/2012	56811	SCHOOL CUSTODIAN II	N	BC02	01	P	A	1.00	33,228	1.00	17,258
EDN150/YC	5/21/2012	58304	CLINICAL PSYCHOLOGIST VI	N	SR26	13	T	A	1.00	80,244	1.00	55,500
EDN400/MD	5/21/2012	14610	SCHOOL COOK II	N	BC06	01	P	A			1.00	38,436
EDN400/OC	5/21/2012	43545	BUILDING MAINTENANCE WORKER I	N	BC09	01	P	A	1.00	44,544	1.00	44,544
EDN300/UA	5/21/2012	42301	DATA PROCSSG SYSTS ANAL VI	N	SR26	13	P	A	1.00	82,128	1.00	28,814
EDN300/UA	5/21/2012	48841	DATA PROCSSG SYSTS ANAL IV	N	SR22	13	P	A	1.00	47,412	1.00	23,663
EDN150/YC	5/23/2012	802221	EDUC ASST I	Y	SR08	03	T	A			1.00	13,327
EDN200/GP	5/24/2012	14585	SECRETARY II	N	SR14	03	P	A	1.00	41,040	1.00	33,756
EDN400/MD	5/29/2012	51890	SCHOOL COOK II	N	BC06	01	P	A			1.00	38,436
EDN400/OC	5/29/2012	39792	BUILDING MAINTENANCE WORKER I	N	BC09	01	P	A	1.00	44,544	1.00	23,134
EDN100/BS	5/29/2012	72058	ROTC INSTRUCTOR	Certificated	ROTC	05	T	A	1.00	86,203	1.00	79,296
EDN100/AA	6/1/2012	48468	SCHOOL CUSTODIAN II	N	BC02	01	P	A	0.50	16,614	0.50	16,614
EDN100/AA	6/1/2012	26564	SCHOOL CUSTODIAN II	N	BC02	01	P	A	1.00	33,228	0.50	8,629
EDN100/AA	6/1/2012	18132	SCHOOL CUSTODIAN II	N	BC02	01	P	A	0.50	16,614	0.50	8,629
EDN300/KO	6/4/2012	69986	PERSONNEL SPECIALIST II	Certificated	E07	06	P	A	1.00	77,069	1.00	77,069
EDN100/AA	6/4/2012	23345	OFFICE ASSISTANT III	N	SR08	03	P	A	1.00	33,756	1.00	13,327
EDN150/YG	6/4/2012	800727	HUMAN SVCS PROF IV	N	SR22	13	P	A	1.00	45,576	1.00	23,663
EDN400/OC	6/4/2012	16793	UTILITY WORKER	N	BC03	01	P	A	1.00	34,164	1.00	17,744
EDN150/YG	6/5/2012	800853	OFFICE ASSISTANT III	N	SR08	03	T	A			1.00	13,327
EDN300/UA	6/8/2012	59154	DP USER SUPPORT TECH I	N	SR13	03	P	A	1.00	35,064	1.00	31,212
EDN100/AA	6/12/2012	19059	ACCOUNT CLERK II	N	SR08	03	P	A	1.00	27,756	1.00	13,327
EDN100/CN	6/12/2012	59815	PERSONNEL CLERK IV	N	SR11	03	T	N			1.00	28,836
EDN100/AA	6/12/2012	56551	ACCOUNT CLERK II	N	SR08	03	P	A	0.50	13,878	0.50	12,834
EDN100/BS	6/28/2012	73393	ROTC INSTRUCTOR	Certificated	ROTC	05	T	A	1.00	86,568	1.00	87,276
EDN100/BS	6/28/2012	73492	ROTC INSTRUCTOR	Certificated	ROTC	05	T	A	1.00	65,796	1.00	80,957
EDN100/AA	7/1/2012	66856	ELEM TEACHER	Certificated	T02	05	P	A	1.00	57,098	1.00	42,509
EDN150/FA	7/1/2012	67506	GEN EDUC/ARTICLE VI TCHR	Certificated	T03	05	P	A	1.00	44,813	1.00	45,909
EDN150/FA	7/1/2012	73917	SPEC ED TEACHER	Certificated	T02	05	P	A	1.00	46,011	1.00	42,509
EDN150/FA	7/1/2012	76165	SPEC ED TEACHER	Certificated	T02	05	P	A	1.00	44,671	1.00	42,509
EDN100/AA	7/1/2012	75813	SECONDARY TEACHER	Certificated	T02	05	P	A	1.00	66,191	1.00	42,509
EDN150/FA	7/1/2012	61852	SPEC ED TEACHER	Certificated	T02	05	P	A	1.00	42,567	1.00	42,509
EDN150/FA	7/1/2012	67268	SPEC ED TEACHER	Certificated	T03	05	P	A	1.00	43,369	1.00	45,909
EDN100/AA	7/1/2012	69798	12-MO SECONDARY TEACHER	Certificated	T02	05	P	A	1.00	61,711	1.00	42,509
EDN150/FA	7/1/2012	76167	SPEC ED TEACHER	Certificated	T02	05	P	A	1.00	40,157	1.00	42,509
EDN150/FA	7/1/2012	74657	SPEC ED TEACHER	Certificated	T02	05	P	A	1.00	56,507	1.00	42,509

Department of Education
New Hires

Table 16

<u>Prog ID/Org</u>	<u>New Hire Effective Date</u>	<u>Position Number</u>	<u>Position Title</u>	<u>Exempt (Y/N)</u>	<u>SR Level</u>	<u>BU Code</u>	<u>T/P</u>	<u>MOF</u>	<u>Budgeted FTE</u>	<u>Budgeted Salary</u>	<u>Actual FTE</u>	<u>Actual Salary</u>
EDN150/FA	7/1/2012	64063	SPEC ED TEACHER	Certificated	T02	05	P	A	1.00	42,602	1.00	42,509
EDN150/FA	7/1/2012	600027	SPEC ED TEACHER	Certificated	T02	05	T	A			1.00	42,509
EDN100/AA	7/2/2012	801943	SCHOOL CUSTODIAN II	N	BC02	01	T	A			0.50	16,614
EDN100/AA	7/2/2012	17491	SCHOOL CUSTODIAN II	N	BC02	01	P	A	0.50	16,614	0.50	16,614
EDN100/AA	7/2/2012	64892	SCH ATHLETIC DIR I	Certificated	E01	06	P	A	1.00	92,334	1.00	60,007
EDN100/BS	7/2/2012	76181	ROTC INSTRUCTOR	Certificated	ROTC	05	T	A	1.00	72,107	1.00	102,870
EDN400/OB	7/2/2012	60008	ASST SUPT,BUSINESS SVCS	N	E00	06	P	A	1.00	98,849	1.00	115,000
EDN100/AA	7/3/2012	802522	DP USER SUPPORT TECH II	N	SR15	03	T	A			1.00	17,528
EDN100/AA	7/3/2012	56573	OFFICE ASSISTANT III	N	SR08	03	P	A	0.50	13,878	0.50	6,664
EDN100/AA	7/3/2012	802706	DP USER SUPPORT TECH II	N	SR15	03	T	A			1.00	17,528
EDN100/AA	7/3/2012	802582	OFFICE ASSISTANT III	N	SR08	03	T	A			0.50	6,664
EDN100/AA	7/3/2012	44325	LIBRARY ASSISTANT III	N	SR07	03	P	A	0.50	12,834	0.50	6,399
EDN100/AA	7/3/2012	802576	DP USER SUPPORT TECH II	N	SR15	03	T	A			1.00	17,528
EDN100/AA	7/3/2012	802659	DP USER SUPPORT TECH II	N	SR15	03	T	A			1.00	17,528
EDN100/AA	7/3/2012	802658	DP USER SUPPORT TECH II	N	SR15	03	T	A			1.00	17,528
EDN100/AA	7/3/2012	801067	OFFICE ASSISTANT III	N	SR08	03	T	A			0.50	6,664
EDN100/AA	7/3/2012	23353	OFFICE ASSISTANT III	N	SR08	03	P	A	1.00	31,212	1.00	13,327
EDN100/BM	7/3/2012	801120	ATHLETIC HLTH CARE TRAINER	Y	SR22	13	P	A	1.00	42,073	1.00	23,663
EDN400/MB	7/3/2012	801150	OFFICE ASSISTANT III	N	SR08	03	T	N	1.00	25,668	1.00	13,327
EDN100/BS	7/3/2012	72056	ROTC INSTRUCTOR	Certificated	ROTC	05	T	A	1.00	70,783	1.00	77,150
EDN150/YC	7/3/2012	59636	BEHAVIORAL HLTH SPCLT III	N	SR20	13	T	A	1.00	42,066	1.00	21,881
EDN300/UA	7/9/2012	66355	TELECOMM DIRECTOR	Certificated	E10	06	P	A	1.00	77,832	1.00	93,626
EDN150/FA	7/9/2012	74584	SPEC ED TEACHER	Certificated	T02	05	P	A	1.00	40,157	1.00	32,222
EDN100/CQ	7/9/2012	73595	EDUCATIONAL SPEC II	Y	E07	06	P	A	1.00	79,242	1.00	77,069
EDN100/AA	7/9/2012	75259	12-MO STUDENT SVCS COORD	Certificated	T03	05	T	A	1.00	59,338	1.00	45,909
EDN400/OC	7/9/2012	34313	ENGINEER V	N	SR26	13	P	A	1.00	63,026	1.00	55,500
EDN100/AA	7/10/2012	68162	SECONDARY TEACHER	Certificated	T02	05	P	A	1.00	57,098	1.00	42,509
EDN150/FA	7/16/2012	63004	SPEC ED TEACHER	Certificated	T02	05	P	A	1.00	42,602	1.00	49,991
EDN100/AA	7/16/2012	65205	ELEM TEACHER	Certificated	T03	05	P	A	1.00	58,810	1.00	53,990
EDN100/AA	7/16/2012	801581	EDUC ASST III	Y	SR12	03	T	A			1.00	25,030
EDN150/FA	7/16/2012	801254	EDUC ASST III	Y	SR12	03	T	A			1.00	25,030
EDN150/FA	7/16/2012	60984	SPEC ED TEACHER	Certificated	T02	05	P	A	1.00	46,157	1.00	49,991
EDN150/FA	7/16/2012	801339	EDUC ASST III	Y	SR12	03	T	A			1.00	25,030
EDN100/AA	7/16/2012	802622	DP USER SUPPORT TECH II	N	SR15	03	T	A			1.00	17,528
EDN400/MB	7/16/2012	802359	SCHOOL LUNCH SERVICES SUPVR	N	SR24	13	T	N			1.00	51,312
EDN100/AA	7/16/2012	69551	ELEM TEACHER	Certificated	T02	05	P	A	1.00	62,391	1.00	49,991
EDN150/FA	7/16/2012	74760	GEN EDUC/ARTICLE VI TCHR	Certificated	T03	05	P	A	1.00	46,157	1.00	53,990
EDN100/AA	7/16/2012	63884	ELEM TEACHER	Certificated	T02	05	P	A	1.00	58,316	1.00	49,991
EDN150/FA	7/16/2012	71905	SPEC ED TCHR/PRE-SCHOOL	Certificated	T03	05	P	A			1.00	53,990
EDN100/AA	7/16/2012	63806	ELEM TEACHER	Certificated	T02	05	P	A	1.00	58,810	1.00	49,991
EDN100/AA	7/16/2012	602630	ELEM TEACHER	Certificated	T02	05	T	A			1.00	49,991
EDN100/AA	7/16/2012	63283	SECONDARY TEACHER	Certificated	T02	05	P	A	1.00	43,048	1.00	49,991
EDN150/FB	7/16/2012	60267	SPECIAL SCH TEACHER	Certificated	T02	05	P	A	1.00	32,577	1.00	37,893
EDN100/AA	7/16/2012	69543	ELEM TEACHER	Certificated	T03	05	P	A	1.00	55,434	1.00	53,990
EDN100/AA	7/16/2012	63012	ELEM TEACHER	Certificated	T03	05	T	A	1.00	51,296	1.00	53,990
EDN100/DB	7/16/2012	602625	ELEM TEACHER	Certificated	T02	05	T	N			1.00	49,991
EDN100/AA	7/16/2012	601655	SECONDARY TEACHER	Certificated	T03	05	T	A			1.00	53,990

Department of Education
New Hires

Table 16

<u>Prog ID/Org</u>	<u>New Hire Effective Date</u>	<u>Position Number</u>	<u>Position Title</u>	<u>Exempt (Y/N)</u>	<u>SR Level</u>	<u>BU Code</u>	<u>T/P</u>	<u>MOF</u>	<u>Budgeted FTE</u>	<u>Budgeted Salary</u>	<u>Actual FTE</u>	<u>Actual Salary</u>
EDN100/AA	7/16/2012	65391	ELEM TEACHER	Certificated	T03	05	P	A	1.00	45,138	1.00	53,990
EDN100/AA	7/16/2012	68753	ELEM TEACHER	Certificated	T02	05	T	A	1.00	48,160	1.00	49,991
EDN400/MB	7/16/2012	802360	SCHOOL LUNCH SERVICES SUPVR	N	SR24	13	T	N			1.00	51,312
EDN150/FA	7/16/2012	72728	SPEC ED TEACHER	Certificated	T03	05	P	A	1.00	43,369	1.00	53,990
EDN100/AA	7/16/2012	68344	ELEM TEACHER	Certificated	T02	05	P	A	1.00	41,794	1.00	49,991
EDN100/AA	7/16/2012	63334	ELEM TEACHER	Certificated	T02	05	T	A	1.00	40,577	1.00	49,991
EDN100/AA	7/16/2012	64752	ELEM TEACHER	Certificated	T02	05	P	A	1.00	50,285	1.00	49,991
EDN100/AA	7/16/2012	64237	ELEM TEACHER	Certificated	T02	05	T	A	1.00	41,794	1.00	49,991
EDN100/DB	7/16/2012	600350	ELEM TEACHER	Certificated	T02	05	T	N			1.00	49,991
EDN100/DB	7/16/2012	79962	ELEM TEACHER	Certificated	T02	05	T	N			1.00	49,991
EDN150/FA	7/16/2012	75535	GEN EDUC/ARTICLE VI TCHR	Certificated	T02	05	T	A	1.00	43,507	1.00	49,991
EDN100/AA	7/16/2012	602629	ELEM TEACHER	Certificated	T02	05	T	A			1.00	49,991
EDN150/FA	7/16/2012	56910	EDUC ASST II	Y	SR10	03	P	A	0.50	12,158	0.50	11,565
EDN150/FA	7/16/2012	71161	SPEC ED TEACHER	Certificated	T02	05	P	A	1.00	46,011	1.00	49,991
EDN100/AA	7/16/2012	65204	ELEM TEACHER	Certificated	T02	05	P	A	1.00	66,191	1.00	49,991
EDN100/AA	7/16/2012	66548	ELEM TEACHER	Certificated	T03	05	P	A	1.00	53,348	1.00	53,990
EDN100/AA	7/16/2012	71257	ELEM TEACHER	Certificated	T03	05	P	A	1.00	45,138	1.00	53,990
EDN150/FA	7/16/2012	66937	SPEC ED TCHR/PRE-SCHOOL	Certificated	T03	05	P	A	1.00	41,362	1.00	53,990
EDN100/AA	7/16/2012	60813	ELEM TEACHER	Certificated	T03	05	P	A	1.00	49,323	1.00	53,990
EDN100/AA	7/16/2012	801303	OFFICE ASSISTANT III	N	SR08	03	T	A			1.00	13,327
EDN150/FA	7/16/2012	63107	GEN EDUC/ARTICLE VI TCHR	Certificated	T03	05	P	A	1.00	44,483	1.00	53,990
EDN100/AA	7/16/2012	63991	ELEM TEACHER	Certificated	T02	05	P	A	1.00	66,191	1.00	49,991
EDN150/FA	7/16/2012	63536	SPEC ED TEACHER	Certificated	T02	05	T	A	1.00	40,157	1.00	49,991
EDN150/FA	7/16/2012	68485	SPEC ED TEACHER	Certificated	T02	05	P	A	1.00	37,747	1.00	49,991
EDN100/AA	7/16/2012	603095	SECONDARY TEACHER	Certificated	T02	05	T	A			1.00	37,893
EDN150/FA	7/16/2012	73794	SPEC ED TEACHER	Certificated	T02	05	P	A	1.00	46,011	1.00	37,893
EDN100/AA	7/16/2012	74302	SECONDARY TEACHER	Certificated	T02	05	P	A	1.00	30,757	1.00	49,991
EDN150/FA	7/16/2012	74669	SPEC ED TEACHER	Certificated	T02	05	P	A	1.00	45,104	1.00	49,991
EDN150/FA	7/16/2012	600787	SPEC ED TCHR/PRE-SCHOOL	Certificated	T02	05	T	A			1.00	49,991
EDN100/AA	7/16/2012	63970	ELEM TEACHER	Certificated	T02	05	P	A	1.00	46,492	1.00	37,893
EDN150/FB	7/16/2012	75020	SPECIAL SCH TEACHER	Certificated	T03	05	P	A	1.00	39,795	1.00	53,990
EDN150/FA	7/16/2012	73321	SPEC ED TEACHER	Certificated	T02	05	P	A	1.00	40,157	1.00	49,991
EDN100/AA	7/16/2012	62637	ELEM TEACHER	Certificated	T02	05	P	A	1.00	45,040	1.00	49,991
EDN150/FA	7/16/2012	602662	SPEC ED TEACHER	Certificated	T02	05	T	A			1.00	49,991
EDN150/FA	7/16/2012	74181	SPEC ED TEACHER	Certificated	T02	05	P	A	1.00	43,369	1.00	49,991
EDN150/FA	7/16/2012	600361	SPEC ED TEACHER	Certificated	T03	05	T	A			1.00	53,990
EDN100/AA	7/16/2012	72534	SECONDARY TEACHER	Certificated	T02	05	P	A	1.00	62,420	1.00	49,991
EDN150/FA	7/16/2012	69196	SPEC ED TEACHER	Certificated	T02	05	P	A	1.00	40,157	1.00	49,991
EDN100/DB	7/16/2012	602549	SECONDARY TEACHER	Certificated	T03	05	T	N			1.00	53,990
EDN150/FA	7/16/2012	67948	SPEC ED TEACHER	Certificated	T02	05	P	A	1.00	47,216	1.00	37,893
EDN100/AA	7/16/2012	63182	SECONDARY TEACHER	Certificated	T02	05	P	A	1.00	43,822	1.00	37,893
EDN100/AA	7/16/2012	600397	ELEM TEACHER	Certificated	T02	05	T	A			1.00	37,893
EDN150/FA	7/16/2012	68549	SPEC ED TEACHER	Certificated	T02	05	P	A	1.00	43,507	1.00	37,893
EDN100/AA	7/16/2012	68650	SECONDARY TEACHER	Certificated	T02	05	P	A	1.00	75,654	1.00	37,893
EDN100/AA	7/16/2012	603111	SECONDARY TEACHER	Certificated	T02	05	T	A			1.00	37,893
EDN100/AA	7/16/2012	603093	SECONDARY TEACHER	Certificated	T02	05	T	A			1.00	37,893
EDN150/FA	7/16/2012	64512	SPEC ED TEACHER	Certificated	T02	05	T	A	1.00	37,747	1.00	37,893

<u>Prog ID/Org</u>	<u>New Hire Effective Date</u>	<u>Position Number</u>	<u>Position Title</u>	<u>Exempt (Y/N)</u>	<u>SR Level</u>	<u>BU Code</u>	<u>T/P</u>	<u>MOF</u>	<u>Budgeted FTE</u>	<u>Budgeted Salary</u>	<u>Actual FTE</u>	<u>Actual Salary</u>
EDN150/FA	7/16/2012	72762	SPEC ED TEACHER	Certificated	T02	05	P	A	1.00	43,369	1.00	37,893
EDN100/AA	7/16/2012	68808	SECONDARY TEACHER	Certificated	T02	05	P	A	1.00	46,492	1.00	37,893
EDN100/AA	7/16/2012	68569	SECONDARY TEACHER	Certificated	T02	05	P	A	1.00	46,492	1.00	37,893
EDN150/FA	7/16/2012	69259	SPEC ED TEACHER	Certificated	T02	05	P	A	1.00	40,157	1.00	37,893
EDN150/FA	7/16/2012	63712	SPEC ED TEACHER	Certificated	T02	05	P	A	1.00	40,157	1.00	37,893
EDN100/AA	7/16/2012	603098	SECONDARY TEACHER	Certificated	T02	05	T	A			1.00	37,893
EDN150/FA	7/16/2012	62156	SPEC ED TEACHER	Certificated	T02	05	P	A	1.00	40,157	1.00	37,893
EDN100/BJ	7/16/2012	73104	SECONDARY TEACHER	Certificated	T02	05	T	A			1.00	37,893
EDN150/FA	7/16/2012	64317	GEN EDUC/ARTICLE VI TCHR	Certificated	T02	05	P	A	1.00	43,507	1.00	37,893
EDN150/FA	7/16/2012	74074	SPEC ED TEACHER	Certificated	T02	05	P	A	1.00	31,352	1.00	37,893
EDN150/FA	7/16/2012	71158	SPEC ED TEACHER	Certificated	T02	05	P	A	1.00	44,671	1.00	37,893
EDN100/DB	7/16/2012	602544	SECONDARY TEACHER	Certificated	T02	05	T	N			1.00	49,991
EDN150/FB	7/16/2012	602861	SPECIAL SCH TEACHER	Certificated	T02	05	P	A			1.00	37,893
EDN100/AA	7/16/2012	44137	SCHOOL CUSTODIAN II	N	BC02	01	P	A	1.00	33,228	1.00	33,228
EDN150/YC	7/16/2012	59135	OFFICE ASSISTANT III	N	SR08	03	T	A	0.50	11,846	0.50	6,664
EDN150/YC	7/16/2012	58542	BEHAVIORAL HLTH SPCLT III	N	SR20	13	T	A	1.00	42,066	1.00	21,881
EDN100/BS	7/16/2012	73494	ROTC INSTRUCTOR	Certificated	ROTC	05	T	A	1.00	72,847	1.00	114,899
EDN100/AA	7/18/2012	802200	DP USER SUPPORT TECH II	N	SR15	03	T	A			1.00	17,528
EDN150/FA	7/18/2012	72127	SPEC ED TEACHER	Certificated	T02	05	P	A	1.00	41,362	1.00	37,893
EDN150/YG	7/18/2012	801669	BEHAVIORAL HLTH SPCLT III	N	SR20	13	T	A			1.00	21,881
EDN150/YC	7/18/2012	58400	BEHAVIORAL HLTH SPCLT III	N	SR20	13	T	A	1.00	42,066	1.00	21,881
EDN100/AA	7/20/2012	802581	DP USER SUPPORT TECH II	N	SR15	03	T	A			1.00	17,528
EDN100/AA	7/23/2012	56504	OFFICE ASSISTANT II	N	SR06	03	P	A	1.00	25,668	1.00	12,301
EDN150/YC	7/23/2012	58651	BEHAVIORAL HLTH SPCLT III	N	SR20	13	T	A	1.00	42,066	1.00	21,881
EDN100/AA	7/23/2012	74998	COUNSELOR/HIGH RISK	Certificated	T02	05	P	A	1.00	58,959	1.00	49,991
EDN150/FA	7/23/2012	60311	GEN EDUC/ARTICLE VI TCHR	Certificated	T03	05	P	A	1.00	43,507	1.00	53,990
EDN100/BM	7/23/2012	800799	ATHLETIC HLTH CARE TRAINER	Y	SR22	13	P	A	1.00	42,073	1.00	45,576
EDN100/AA	7/23/2012	603039	SECONDARY TEACHER	Certificated	T02	05	T	A			1.00	37,893
EDN100/AA	7/23/2012	56449	OFFICE ASSISTANT III	N	SR08	03	P	A	0.50	16,212	0.50	6,664
EDN100/AA	7/23/2012	46276	SCHOOL CUSTODIAN II	N	BC02	01	P	A	0.50	16,614	0.50	16,614
EDN150/YC	7/23/2012	58670	SCHOOL PSYCHOLOGIST	Y	SR24	13	P	A	1.00	55,401	1.00	51,312
EDN500/PC	7/23/2012	802662	OFFICE ASSISTANT III	N	SR08	03	P	A			0.50	6,664
EDN150/FA	7/24/2012	603367	SPEC ED TEACHER	Certificated	T02	05	T	A			1.00	42,509
EDN100/AA	7/24/2012	72727	SECONDARY TEACHER	Certificated	T03	05	P	A	1.00	53,897	0.50	22,955
EDN100/AA	7/24/2012	74232	SECONDARY TEACHER	Certificated	T02	05	T	A	0.50	22,569	1.00	42,509
EDN150/FA	7/24/2012	63950	SPEC ED TCHR/PRE-SCHOOL	Certificated	T02	05	P	A	1.00	67,472	1.00	42,509
EDN100/AA	7/24/2012	62892	ELEM TEACHER	Certificated	T03	05	P	A	1.00	44,339	1.00	45,909
EDN100/AA	7/24/2012	63241	SECONDARY TEACHER	Certificated	T02	05	P	A	1.00	57,145	1.00	42,509
EDN150/FA	7/24/2012	64521	SPEC ED TEACHER	Certificated	T02	05	P	A	1.00	46,011	1.00	32,222
EDN150/FA	7/24/2012	74077	SPEC ED TEACHER	Certificated	T03	05	P	A	1.00	44,671	1.00	45,909
EDN100/AA	7/24/2012	75199	COUNSELOR/HIGH RISK	Certificated	T03	05	P	A	1.00	49,448	1.00	45,909
EDN100/AA	7/24/2012	62838	ELEM TEACHER	Certificated	T02	05	P	A	1.00	68,177	1.00	42,509
EDN100/AA	7/24/2012	68187	LIBRARIAN	Certificated	T02	05	P	A	1.00	80,465	1.00	42,509
EDN100/AA	7/24/2012	29373	SCHOOL HEALTH AIDE	N	SR09	03	P	A	1.00	19,575	1.00	13,867
EDN150/FA	7/24/2012	601831	SPEC ED TEACHER	Certificated	T02	05	T	A			1.00	32,222
EDN100/AA	7/24/2012	66361	ELEM TEACHER	Certificated	T02	05	P	A	1.00	60,575	1.00	42,509
EDN100/AA	7/24/2012	64604	ELEM TEACHER	Certificated	T02	05	P	A	1.00	68,177	1.00	42,509

<u>Prog ID/Org</u>	<u>New Hire Effective Date</u>	<u>Position Number</u>	<u>Position Title</u>	<u>Exempt (Y/N)</u>	<u>SR Level</u>	<u>BU Code</u>	<u>T/P</u>	<u>MOF</u>	<u>Budgeted FTE</u>	<u>Budgeted Salary</u>	<u>Actual FTE</u>	<u>Actual Salary</u>
EDN100/AA	7/24/2012	76038	SECONDARY TEACHER	Certificated	T02	05	P	A	1.00	40,577	1.00	42,509
EDN100/DB	7/24/2012	79526	ELEM TEACHER	Certificated	T02	05	T	N			1.00	42,509
EDN100/AA	7/24/2012	61984	ELEM TEACHER	Certificated	T02	05	P	A	1.00	51,426	1.00	42,509
EDN100/AA	7/24/2012	601465	ELEM TEACHER	Certificated	T02	05	T	A			1.00	42,509
EDN100/AA	7/24/2012	66315	SECONDARY TEACHER	Certificated	T02	05	P	A	1.00	79,138	1.00	42,509
EDN150/FA	7/24/2012	65326	SPEC ED TCHR/PRE-SCHOOL	Certificated	T03	05	P	A	1.00	47,390	1.00	45,909
EDN100/AA	7/24/2012	67377	ELEM TEACHER	Certificated	T02	05	T	A	1.00	62,550	1.00	42,509
EDN100/AA	7/24/2012	602802	SECONDARY TEACHER	Certificated	T03	05	T	A			1.00	45,909
EDN100/AA	7/24/2012	601437	SECONDARY TEACHER	Certificated	T03	05	T	A			1.00	45,909
EDN150/FA	7/24/2012	69582	SPEC ED TEACHER	Certificated	T02	05	P	A	1.00	65,506	1.00	42,509
EDN100/AA	7/24/2012	64450	SECONDARY TEACHER	Certificated	T02	05	P	A	1.00	62,445	1.00	42,509
EDN150/FA	7/24/2012	66131	SPEC ED TEACHER	Certificated	T02	05	P	A	1.00	43,369	1.00	42,509
EDN150/SA	7/24/2012	30411	SPEECH PATHOLOGIST II	Y	SR18	13	P	A	1.00	61,990	1.00	38,988
EDN150/FA	7/24/2012	603360	GEN EDUC/ARTICLE VI TCHR	Certificated	T03	05	T	A			1.00	45,909
EDN100/AA	7/24/2012	76266	ELEM TEACHER	Certificated	T03	05	P	A	1.00	41,794	1.00	45,909
EDN100/AA	7/24/2012	60675	SECONDARY TEACHER	Certificated	T02	05	P	A	1.00	40,577	1.00	42,509
EDN100/AA	7/24/2012	602400	SECONDARY TEACHER	Certificated	T02	05	T	A			1.00	42,509
EDN150/FA	7/24/2012	62273	SPEC ED TEACHER	Certificated	T03	05	P	A	1.00	52,728	1.00	45,909
EDN100/AA	7/24/2012	69349	ELEM TEACHER	Certificated	T03	05	T	A	1.00	43,822	1.00	34,799
EDN100/AA	7/24/2012	69704	ELEM TEACHER	Certificated	T03	05	P	A	1.00	40,577	1.00	45,909
EDN100/AA	7/24/2012	73767	SECONDARY TEACHER	Certificated	T02	05	P	A	1.00	40,577	1.00	42,509
EDN100/AA	7/24/2012	603100	SECONDARY TEACHER	Certificated	T02	05	T	A			0.50	21,255
EDN150/FA	7/24/2012	68235	SPEC ED TEACHER	Certificated	T02	05	P	A	1.00	37,747	1.00	42,509
EDN100/AA	7/24/2012	67205	SECONDARY TEACHER	Certificated	T02	05	P	A	1.00	47,886	1.00	42,509
EDN150/SA	7/24/2012	56374	SPEECH PATHOLOGIST II	Y	SR18	13	P	A	1.00	54,027	1.00	38,988
EDN100/AA	7/24/2012	603421	ELEM TEACHER	Certificated	T03	05	T	A			1.00	45,909
EDN100/AA	7/24/2012	68053	ELEM TEACHER	Certificated	T02	05	P	A	1.00	43,822	1.00	42,509
EDN150/FA	7/24/2012	603475	SPEC ED TEACHER	Certificated	T02	05	T	A			1.00	42,509
EDN100/AA	7/24/2012	603381	ELEM TEACHER	Certificated	T02	05	T	A			1.00	42,509
EDN100/AA	7/24/2012	63571	ELEM TEACHER	Certificated	T02	05	P	A	1.00	55,434	1.00	32,222
EDN150/FA	7/24/2012	73281	SPEC ED TEACHER	Certificated	T03	05	P	A	1.00	42,602	1.00	45,909
EDN100/AA	7/24/2012	29369	SCHOOL HEALTH AIDE	N	SR09	03	P	A	1.00	21,999	1.00	18,078
EDN100/AA	7/24/2012	68157	ELEM TEACHER	Certificated	T02	05	P	A	1.00	47,709	1.00	42,509
EDN100/AA	7/24/2012	65353	ELEM TEACHER	Certificated	T02	05	T	A	1.00	60,627	1.00	42,509
EDN100/AA	7/24/2012	65897	SECONDARY TEACHER	Certificated	T03	05	P	A	1.00	43,822	1.00	45,909
EDN150/FA	7/24/2012	71306	SPEC ED TEACHER	Certificated	T02	05	P	A	1.00	57,692	1.00	32,222
EDN100/AA	7/24/2012	603386	SECONDARY TEACHER	Certificated	T02	05	T	A			1.00	42,509
EDN150/FA	7/24/2012	75718	GEN EDUC/ARTICLE VI TCHR	Certificated	T02	05	T	A	1.00	43,507	1.00	42,509
EDN150/FA	7/24/2012	603213	GEN EDUC/ARTICLE VI TCHR	Certificated	T03	05	T	A			1.00	45,909
EDN100/AA	7/24/2012	60192	ELEM TEACHER	Certificated	T03	05	P	A	1.00	62,391	1.00	45,909
EDN100/AA	7/24/2012	71121	ELEM TEACHER	Certificated	T02	05	P	A	1.00	63,699	1.00	42,509
EDN100/AA	7/24/2012	66785	ELEM TEACHER	Certificated	T02	05	P	A	1.00	45,138	1.00	42,509
EDN150/FA	7/24/2012	601841	SPEC ED TEACHER	Certificated	T03	05	T	A			1.00	45,909
EDN150/FA	7/24/2012	67382	SPEC ED TEACHER	Certificated	T03	05	P	A	1.00	73,666	1.00	45,909
EDN150/FA	7/24/2012	60908	GEN EDUC/ARTICLE VI TCHR	Certificated	T02	05	T	A			1.00	42,509
EDN150/FA	7/24/2012	75775	GEN EDUC/ARTICLE VI TCHR	Certificated	T02	05	P	A	1.00	48,979	1.00	42,509
EDN100/AA	7/24/2012	66173	SECONDARY TEACHER	Certificated	T03	05	P	A	1.00	40,577	1.00	45,909

<u>Prog ID/Org</u>	<u>New Hire Effective Date</u>	<u>Position Number</u>	<u>Position Title</u>	<u>Exempt (Y/N)</u>	<u>SR Level</u>	<u>BU Code</u>	<u>T/P</u>	<u>MOF</u>	<u>Budgeted FTE</u>	<u>Budgeted Salary</u>	<u>Actual FTE</u>	<u>Actual Salary</u>
EDN150/FA	7/24/2012	67970	SPEC ED TEACHER	Certificated	T02	05	P	A	1.00	46,011	1.00	42,509
EDN150/FA	7/24/2012	67448	GEN EDUC/ARTICLE VI TCHR	Certificated	T03	05	P	A	1.00	46,605	1.00	45,909
EDN100/AA	7/24/2012	602397	SECONDARY TEACHER	Certificated	T03	05	T	A			1.00	45,909
EDN100/AA	7/24/2012	60546	ELEM TEACHER	Certificated	T02	05	P	A	1.00	60,575	1.00	42,509
EDN150/FA	7/24/2012	601184	SPEC ED TEACHER	Certificated	T03	05	T	A			1.00	45,909
EDN150/FA	7/24/2012	66003	SPEC ED TEACHER	Certificated	T03	05	T	A	1.00	44,671	1.00	45,909
EDN100/AA	7/24/2012	72105	SECONDARY TEACHER	Certificated	T03	05	P	A	1.00	43,822	1.00	45,909
EDN150/FA	7/24/2012	603451	SPEC ED TCHR/PRE-SCHOOL	Certificated	T03	05	T	A			1.00	45,909
EDN100/AA	7/24/2012	64256	ELEM TEACHER	Certificated	T03	05	P	A	1.00	43,048	1.00	45,909
EDN150/FA	7/24/2012	67430	SPEC ED TEACHER	Certificated	T02	05	P	A	1.00	69,496	1.00	32,222
EDN100/AA	7/24/2012	68971	ELEM TEACHER	Certificated	T02	05	P	A	1.00	68,177	1.00	42,509
EDN100/AA	7/24/2012	61710	SECONDARY TEACHER	Certificated	T03	05	P	A	1.00	49,801	1.00	45,909
EDN100/BJ	7/24/2012	603146	SECONDARY TEACHER	Certificated	T02	05	T	A			1.00	42,509
EDN150/FA	7/24/2012	600143	SPEC ED TEACHER	Certificated	T02	05	T	A			1.00	42,509
EDN100/AA	7/24/2012	63063	ELEM TEACHER	Certificated	T03	05	P	A	1.00	42,777	1.00	45,909
EDN100/AA	7/24/2012	63988	ELEM TEACHER	Certificated	T02	05	P	A	1.00	50,285	1.00	42,509
EDN100/AA	7/24/2012	603532	ELEM TEACHER	Certificated	T02	05	T	A			1.00	42,509
EDN100/DB	7/24/2012	74596	ELEM TEACHER	Certificated	T02	05	T	N			1.00	42,509
EDN150/FA	7/24/2012	74426	SPEC ED TEACHER	Certificated	T03	05	P	A	1.00	41,362	1.00	45,909
EDN100/AA	7/24/2012	69748	ELEM TEACHER	Certificated	T02	05	P	A	1.00	60,078	1.00	42,509
EDN150/FA	7/24/2012	74102	SPEC ED TEACHER	Certificated	T03	05	P	A	1.00	59,174	1.00	45,909
EDN100/AA	7/24/2012	69836	ELEM TEACHER	Certificated	T03	05	P	A	1.00	66,191	1.00	45,909
EDN100/AA	7/24/2012	61608	ELEM TEACHER	Certificated	T03	05	P	A	1.00	45,138	1.00	45,909
EDN150/FA	7/24/2012	60905	SPEC ED TEACHER	Certificated	T02	05	P	A	1.00	43,369	1.00	42,509
EDN100/DB	7/24/2012	601162	SECONDARY TEACHER	Certificated	T02	05	T	N			1.00	42,509
EDN100/AA	7/24/2012	602120	ELEM TEACHER	Certificated	T02	05	T	A			1.00	42,509
EDN150/FA	7/24/2012	66214	SPEC ED TEACHER	Certificated	T02	05	P	A	1.00	43,369	1.00	42,509
EDN100/AA	7/24/2012	60888	ELEM TEACHER	Certificated	T02	05	P	A	1.00	64,264	1.00	42,509
EDN100/AA	7/24/2012	69884	ELEM TEACHER	Certificated	T02	05	P	A	1.00	45,138	1.00	42,509
EDN100/AA	7/24/2012	62938	ELEM TEACHER	Certificated	T03	05	P	A	1.00	55,434	1.00	45,909
EDN100/AA	7/24/2012	602587	SECONDARY TEACHER	Certificated	T03	05	T	A			1.00	45,909
EDN100/AA	7/24/2012	600131	ELEM TEACHER	Certificated	T02	05	T	A			1.00	42,509
EDN150/FA	7/24/2012	65627	SPEC ED TEACHER	Certificated	T02	05	P	A	1.00	42,602	1.00	32,222
EDN150/FA	7/24/2012	75534	GEN EDUC/ARTICLE VI TCHR	Certificated	T03	05	T	A			1.00	45,909
EDN100/AA	7/24/2012	600325	SECONDARY TEACHER	Certificated	T03	05	T	A			1.00	45,909
EDN100/AA	7/24/2012	601436	SECONDARY TEACHER	Certificated	T02	05	T	A			1.00	42,509
EDN100/AA	7/24/2012	65862	ELEM TEACHER	Certificated	T03	05	P	A	1.00	40,577	1.00	45,909
EDN100/AA	7/24/2012	64460	SECONDARY TEACHER	Certificated	T03	05	P	A	1.00	79,138	1.00	45,909
EDN100/AA	7/24/2012	64870	SECONDARY TEACHER	Certificated	T02	05	P	A	1.00	50,285	1.00	42,509
EDN100/AA	7/24/2012	603569	ELEM TEACHER	Certificated	T03	05	T	A			1.00	45,909
EDN150/FA	7/24/2012	62613	GEN EDUC/ARTICLE VI TCHR	Certificated	T02	05	P	A	1.00	63,855	1.00	42,509
EDN150/FA	7/24/2012	602035	GEN EDUC/ARTICLE VI TCHR	Certificated	T03	05	T	A			1.00	45,909
EDN150/FA	7/24/2012	601151	SPEC ED TEACHER	Certificated	T03	05	T	A			1.00	45,909
EDN100/AA	7/24/2012	69787	COUNSELOR	Certificated	T03	05	P	A	1.00	54,358	1.00	45,909
EDN100/AA	7/24/2012	61354	ELEM TEACHER	Certificated	T02	05	P	A	1.00	68,177	1.00	42,509
EDN100/AA	7/24/2012	72948F	COUNSELOR/HIGH RISK	Certificated	T02	05	P	A	1.00	50,743	1.00	42,509
EDN150/NB	7/24/2012	79501	DIST OFF TCHR	Certificated	T03	05	T	N			1.00	45,909

<u>Prog ID/Org</u>	<u>New Hire Effective Date</u>	<u>Position Number</u>	<u>Position Title</u>	<u>Exempt (Y/N)</u>	<u>SR Level</u>	<u>BU Code</u>	<u>T/P</u>	<u>MOF</u>	<u>Budgeted FTE</u>	<u>Budgeted Salary</u>	<u>Actual FTE</u>	<u>Actual Salary</u>
EDN150/FA	7/24/2012	73255	SPEC ED TEACHER	Certificated	T02	05	P	A	1.00	49,286	1.00	32,222
EDN100/AA	7/24/2012	65885	SECONDARY TEACHER	Certificated	T02	05	P	A	1.00	38,142	1.00	42,509
EDN100/AA	7/24/2012	71736	ELEM TEACHER	Certificated	T03	05	P	A	1.00	46,492	1.00	45,909
EDN100/AA	7/24/2012	29415	SCHOOL HEALTH AIDE	N	SR09	03	P	A	1.00	22,852	1.00	13,867
EDN150/FA	7/24/2012	603184	SPEC ED TEACHER	Certificated	T02	05	T	A			1.00	32,222
EDN100/AA	7/24/2012	71142	ELEM TEACHER	Certificated	T02	05	P	A	1.00	75,983	1.00	42,509
EDN150/FA	7/24/2012	75500	SPEC ED TEACHER	Certificated	T02	05	T	A	1.00	59,422	1.00	42,509
EDN100/AA	7/24/2012	63034	SECONDARY TEACHER	Certificated	T02	05	P	A	1.00	51,296	1.00	42,509
EDN150/FA	7/24/2012	73481	SPEC ED TEACHER	Certificated	T02	05	P	A	1.00	50,737	1.00	42,509
EDN100/AA	7/24/2012	62740	ELEM TEACHER	Certificated	T02	05	P	A	1.00	46,492	1.00	42,509
EDN100/AA	7/24/2012	72238	SECONDARY TEACHER	Certificated	T03	05	P	A	1.00	54,419	1.00	45,909
EDN100/AA	7/24/2012	603571	ELEM TEACHER	Certificated	T02	05	T	A			1.00	42,509
EDN100/AA	7/24/2012	601256	ELEM TEACHER	Certificated	T03	05	T	A			1.00	45,909
EDN100/AA	7/24/2012	602984	ELEM TEACHER	Certificated	T02	05	T	A			1.00	42,509
EDN150/FA	7/24/2012	64080	SPEC ED TCHR/PRE-SCHOOL	Certificated	T03	05	P	A	1.00	52,230	1.00	45,909
EDN150/FA	7/24/2012	603479	GEN EDUC/ARTICLE VI TCHR	Certificated	T02	05	T	A			1.00	42,509
EDN150/FA	7/24/2012	72305	SPEC ED TEACHER	Certificated	T03	05	T	A	1.00	44,671	1.00	45,909
EDN100/AA	7/24/2012	73879	SECONDARY TEACHER	Certificated	T02	05	P	A	1.00	48,351	1.00	42,509
EDN150/FA	7/24/2012	74754	SPEC ED TEACHER	Certificated	T02	05	P	A			1.00	32,222
EDN100/AA	7/24/2012	64783	SECONDARY TEACHER	Certificated	T02	05	P	A	1.00	45,138	1.00	42,509
EDN100/AA	7/24/2012	63366	ELEM TEACHER	Certificated	T02	05	P	A	1.00	45,138	1.00	42,509
EDN100/AA	7/24/2012	66497	SECONDARY TEACHER	Certificated	T02	05	P	A	1.00	58,894	1.00	42,509
EDN100/AA	7/24/2012	60478	ELEM TEACHER	Certificated	T03	05	P	A	1.00	58,081	1.00	45,909
EDN150/FA	7/24/2012	74872	GEN EDUC/ARTICLE VI TCHR	Certificated	T02	05	P	A	1.00	44,813	1.00	42,509
EDN100/AA	7/24/2012	601636	ELEM TEACHER	Certificated	T02	05	T	A			1.00	42,509
EDN100/AA	7/24/2012	64019	SECONDARY TEACHER	Certificated	T02	05	P	A	1.00	43,822	1.00	42,509
EDN100/AA	7/24/2012	69477	ELEM TEACHER	Certificated	T03	05	P	A	1.00	53,348	1.00	45,909
EDN100/AA	7/24/2012	66042	LIBRARIAN	Certificated	T03	05	P	A	1.00	73,808	0.50	22,955
EDN100/AA	7/24/2012	602745	COUNSELOR	Certificated	T02	05	T	A			1.00	42,509
EDN150/FA	7/24/2012	66643	SPEC ED TEACHER	Certificated	T02	05	P	A	1.00	44,671	1.00	32,222
EDN100/AA	7/24/2012	603530	ELEM TEACHER	Certificated	T03	05	T	A			1.00	45,909
EDN100/AA	7/24/2012	61480	ELEM TEACHER	Certificated	T02	05	P	A	1.00	48,868	1.00	42,509
EDN100/AA	7/24/2012	601291	10-MO STUDENT SVCS COORD	Certificated	T03	05	T	A			0.50	22,955
EDN100/AA	7/24/2012	67904	LIBRARIAN	Certificated	T02	05	P	A	1.00	75,983	1.00	42,509
EDN100/AA	7/24/2012	69634	ELEM TEACHER	Certificated	T02	05	P	A	1.00	51,400	1.00	42,509
EDN100/AA	7/24/2012	63414	ELEM TEACHER	Certificated	T02	05	P	A	1.00	46,492	1.00	42,509
EDN150/FA	7/24/2012	62149	SPEC ED TEACHER	Certificated	T03	05	P	A	1.00	57,712	1.00	45,909
EDN150/FA	7/24/2012	603229	SPEC ED TEACHER	Certificated	T02	05	T	A			1.00	42,509
EDN100/AA	7/24/2012	69912	ELEM TEACHER	Certificated	T02	05	P	A	1.00	47,886	1.00	42,509
EDN100/AA	7/24/2012	603422	ELEM TEACHER	Certificated	T02	05	T	A			1.00	42,509
EDN100/AA	7/24/2012	603424	ELEM TEACHER	Certificated	T02	05	T	A			1.00	42,509
EDN150/FA	7/24/2012	60342	SPEC ED TEACHER	Certificated	T02	05	P	A	1.00	41,362	1.00	42,509
EDN100/AA	7/24/2012	60331	ELEM TEACHER	Certificated	T02	05	P	A	1.00	45,138	1.00	42,509
EDN100/AA	7/24/2012	63175	SECONDARY TEACHER	Certificated	T02	05	P	A	1.00	46,492	1.00	42,509
EDN150/FA	7/24/2012	602067	GEN EDUC/ARTICLE VI TCHR	Certificated	T03	05	T	A			1.00	45,909
EDN100/AA	7/24/2012	67702	ELEM TEACHER	Certificated	T02	05	P	A	1.00	48,868	1.00	42,509
EDN150/FA	7/24/2012	71343	SPEC ED TCHR/PRE-SCHOOL	Certificated	T02	05	P	A	1.00	69,496	1.00	42,509

<u>Prog ID/Org</u>	<u>New Hire Effective Date</u>	<u>Position Number</u>	<u>Position Title</u>	<u>Exempt (Y/N)</u>	<u>SR Level</u>	<u>BU Code</u>	<u>T/P</u>	<u>MOF</u>	<u>Budgeted FTE</u>	<u>Budgeted Salary</u>	<u>Actual FTE</u>	<u>Actual Salary</u>
EDN100/AA	7/24/2012	64009	ELEM TEACHER	Certificated	T02	05	P	A	1.00	55,482	1.00	42,509
EDN100/AA	7/24/2012	75808	ELEM TEACHER	Certificated	T02	05	T	A			1.00	42,509
EDN100/AA	7/24/2012	73575	SECONDARY TEACHER	Certificated	T02	05	P	A	1.00	70,222	1.00	42,509
EDN100/AA	7/24/2012	75110	ELEM TEACHER	Certificated	T02	05	P	A	1.00	43,822	1.00	42,509
EDN100/AA	7/24/2012	603417	SECONDARY TEACHER	Certificated	T02	05	T	A			1.00	42,509
EDN100/AA	7/24/2012	600112	ELEM TEACHER	Certificated	T02	05	T	A			1.00	42,509
EDN100/AA	7/24/2012	603411	ELEM TEACHER	Certificated	T03	05	T	A			1.00	45,909
EDN150/FA	7/24/2012	76057	SPEC ED TEACHER	Certificated	T02	05	P	A	1.00	43,369	1.00	42,509
EDN100/AA	7/24/2012	74570	ELEM TEACHER	Certificated	T02	05	P	A	1.00	53,866	1.00	42,509
EDN150/FA	7/24/2012	603471	SPEC ED TCHR/PRE-SCHOOL	Certificated	T02	05	T	A			1.00	42,509
EDN150/FA	7/24/2012	63399	SPEC ED TEACHER	Certificated	T02	05	P	A	1.00	49,924	1.00	42,509
EDN100/AA	7/24/2012	69401	ELEM TEACHER	Certificated	T02	05	P	A	1.00	70,222	1.00	42,509
EDN150/FA	7/24/2012	71915	SPEC ED TEACHER	Certificated	T02	05	P	A	1.00	40,157	1.00	42,509
EDN150/FA	7/24/2012	601895	SPEC ED TEACHER	Certificated	T03	05	T	A			1.00	45,909
EDN150/FA	7/24/2012	69370	SPEC ED TEACHER	Certificated	T02	05	P	A	1.00	44,671	1.00	42,509
EDN100/AA	7/24/2012	603564	SECONDARY TEACHER	Certificated	T02	05	T	A			1.00	42,509
EDN150/FA	7/24/2012	74159	SPEC ED TEACHER	Certificated	T03	05	P	A	1.00	51,755	1.00	45,909
EDN100/AA	7/24/2012	66385	SECONDARY TEACHER	Certificated	T03	05	P	A	1.00	40,577	1.00	45,909
EDN100/AA	7/24/2012	63628	ELEM TEACHER	Certificated	T02	05	P	A	1.00	68,177	1.00	42,509
EDN150/FA	7/24/2012	69406	SPEC ED TEACHER	Certificated	T03	05	P	A	1.00	48,813	1.00	45,909
EDN100/AA	7/24/2012	61628	ELEM TEACHER	Certificated	T02	05	P	A	1.00	57,098	1.00	42,509
EDN100/AA	7/24/2012	62902	SECONDARY TEACHER	Certificated	T02	05	P	A	1.00	46,492	1.00	42,509
EDN150/FA	7/24/2012	603076	GEN EDUC/ARTICLE VI TCHR	Certificated	T02	05	T	A			1.00	42,509
EDN100/AA	7/24/2012	69115	SECONDARY TEACHER	Certificated	T02	05	P	A	1.00	43,822	1.00	42,509
EDN100/AA	7/24/2012	64719	ELEM TEACHER	Certificated	T02	05	P	A	1.00	58,810	1.00	42,509
EDN100/AA	7/24/2012	60625	ELEM TEACHER	Certificated	T02	05	P	A	1.00	45,138	1.00	42,509
EDN100/AA	7/24/2012	69886	ELEM TEACHER	Certificated	T02	05	P	A	1.00	71,440	1.00	42,509
EDN100/AA	7/24/2012	603236	SECONDARY TEACHER	Certificated	T03	05	T	A			0.50	22,955
EDN100/AA	7/24/2012	602885	ELEM TEACHER	Certificated	T02	05	T	A			1.00	42,509
EDN100/AA	7/24/2012	72550	SECONDARY TEACHER	Certificated	T03	05	P	A	1.00	48,451	1.00	45,909
EDN150/FA	7/24/2012	71126	SPEC ED TEACHER	Certificated	T03	05	P	A	1.00	57,205	1.00	45,909
EDN100/AA	7/24/2012	69209	SECONDARY TEACHER	Certificated	T03	05	P	A	1.00	48,351	1.00	45,909
EDN150/FA	7/24/2012	66459	SPEC ED TEACHER	Certificated	T02	05	P	A	1.00	49,765	1.00	42,509
EDN100/AA	7/24/2012	68653	SECONDARY TEACHER	Certificated	T03	05	P	A	1.00	67,173	1.00	45,909
EDN100/AA	7/24/2012	71730	ELEM TEACHER	Certificated	T02	05	P	A	1.00	49,334	1.00	42,509
EDN100/AA	7/24/2012	67191	SECONDARY TEACHER	Certificated	T03	05	P	A	1.00	43,822	1.00	45,909
EDN100/AA	7/24/2012	603062	ELEM TEACHER	Certificated	T02	05	T	A			1.00	42,509
EDN100/AA	7/24/2012	603540	ELEM TEACHER	Certificated	T02	05	T	A			1.00	42,509
EDN100/AA	7/24/2012	600503	SECONDARY TEACHER	Certificated	T02	05	T	A			1.00	42,509
EDN100/AA	7/24/2012	603443	ELEM TEACHER	Certificated	T02	05	T	A			1.00	42,509
EDN150/FA	7/24/2012	67005	SPEC ED TEACHER	Certificated	T02	05	T	A	1.00	56,010	1.00	42,509
EDN100/AA	7/24/2012	67759	ELEM TEACHER	Certificated	T02	05	P	A	1.00	64,264	1.00	42,509
EDN150/FA	7/24/2012	603187	GEN EDUC/ARTICLE VI TCHR	Certificated	T02	05	T	A			1.00	42,509
EDN100/AA	7/24/2012	60445	ELEM TEACHER	Certificated	T02	05	P	A	1.00	46,558	1.00	42,509
EDN150/FA	7/24/2012	71846	SPEC ED TEACHER	Certificated	T02	05	P	A	1.00	59,422	1.00	42,509
EDN100/AA	7/24/2012	603568	ELEM TEACHER	Certificated	T02	05	T	A			1.00	42,509
EDN100/BB	7/24/2012	60997	SECONDARY TEACHER	Certificated	T02	05	P	A	1.00	55,264	1.00	42,509

Department of Education
New Hires

Table 16

<u>Prog ID/Org</u>	<u>New Hire Effective Date</u>	<u>Position Number</u>	<u>Position Title</u>	<u>Exempt (Y/N)</u>	<u>SR Level</u>	<u>BU Code</u>	<u>T/P</u>	<u>MOF</u>	<u>Budgeted FTE</u>	<u>Budgeted Salary</u>	<u>Actual FTE</u>	<u>Actual Salary</u>
EDN100/AA	7/24/2012	61156	ELEM TEACHER	Certificated	T02	05	P	A	1.00	43,822	1.00	42,509
EDN100/AA	7/24/2012	65962	ELEM TEACHER	Certificated	T03	05	P	A	1.00	46,492	1.00	45,909
EDN150/FA	7/24/2012	62423	SPEC ED TEACHER	Certificated	T03	05	P	A	1.00	51,421	1.00	45,909
EDN100/AA	7/24/2012	600822	ELEM TEACHER	Certificated	T03	05	T	A			1.00	45,909
EDN150/FA	7/24/2012	75721	GEN EDUC/ARTICLE VI TCHR	Certificated	T02	05	T	A	1.00	42,738	1.00	42,509
EDN100/AA	7/24/2012	73752	SECONDARY TEACHER	Certificated	T02	05	P	A	1.00	46,492	1.00	42,509
EDN150/FA	7/24/2012	74528	GEN EDUC/ARTICLE VI TCHR	Certificated	T03	05	P	A	1.00	43,507	1.00	45,909
EDN100/AA	7/24/2012	62288	ELEM TEACHER	Certificated	T02	05	P	A	1.00	53,348	1.00	42,509
EDN150/FA	7/24/2012	72753	SPEC ED TCHR/PRE-SCHOOL	Certificated	T02	05	P	A	1.00	46,011	1.00	32,222
EDN150/FA	7/24/2012	63222	SPEC ED TEACHER	Certificated	T02	05	P	A	1.00	42,602	1.00	42,509
EDN100/AA	7/24/2012	75318	COUNSELOR/HIGH RISK	Certificated	T03	05	T	A			1.00	45,909
EDN150/FA	7/24/2012	61151	SPEC ED TCHR/PRE-SCHOOL	Certificated	T02	05	P	A	1.00	30,439	1.00	42,509
EDN100/AA	7/24/2012	600844	SECONDARY TEACHER	Certificated	T02	05	T	A			1.00	42,509
EDN100/AA	7/24/2012	60609	ELEM TEACHER	Certificated	T02	05	P	A	1.00	43,822	1.00	42,509
EDN100/AA	7/24/2012	600745	ELEM TEACHER	Certificated	T03	05	T	A			1.00	45,909
EDN150/FA	7/24/2012	72772	SPEC ED TEACHER	Certificated	T03	05	P	A	1.00	44,671	1.00	45,909
EDN100/AA	7/24/2012	68414	SECONDARY TEACHER	Certificated	T03	05	P	A	1.00	66,191	1.00	45,909
EDN100/AA	7/24/2012	63854	SECONDARY TEACHER	Certificated	T03	05	P	A	1.00	75,419	1.00	45,909
EDN150/FA	7/24/2012	63746	SPEC ED TEACHER	Certificated	T03	05	P	A	1.00	46,457	1.00	45,909
EDN100/AA	7/24/2012	71642	SECONDARY TEACHER	Certificated	T02	05	P	A	1.00	45,138	1.00	42,509
EDN100/AA	7/24/2012	66966	ELEM TEACHER	Certificated	T03	05	T	A	1.00	46,492	1.00	45,909
EDN100/AA	7/24/2012	63445	ELEM TEACHER	Certificated	T02	05	P	A	1.00	56,699	1.00	42,509
EDN100/AA	7/24/2012	65503	ELEM TEACHER	Certificated	T02	05	P	A	1.00	71,440	1.00	42,509
EDN100/AA	7/24/2012	65818	SECONDARY TEACHER	Certificated	T02	05	P	A	1.00	57,179	1.00	42,509
EDN150/FA	7/24/2012	603204	SPEC ED TEACHER	Certificated	T02	05	T	A			1.00	42,509
EDN150/FA	7/24/2012	62392	SPEC ED TEACHER	Certificated	T02	05	P	A	1.00	42,602	1.00	42,509
EDN100/AA	7/24/2012	66993	SECONDARY TEACHER	Certificated	T02	05	P	A	1.00	48,351	1.00	32,222
EDN100/AA	7/24/2012	69390	SECONDARY TEACHER	Certificated	T03	05	P	A	1.00	43,822	1.00	45,909
EDN150/FA	7/24/2012	603215	GEN EDUC/ARTICLE VI TCHR	Certificated	T02	05	T	A			1.00	42,509
EDN100/AA	7/24/2012	603412	ELEM TEACHER	Certificated	T03	05	T	A			1.00	45,909
EDN150/FA	7/24/2012	69879	SPEC ED TEACHER	Certificated	T03	05	P	A	1.00	44,671	1.00	45,909
EDN100/AA	7/24/2012	67476	ELEM TEACHER	Certificated	T03	05	T	A	1.00	55,482	1.00	45,909
EDN150/FA	7/24/2012	69851	GEN EDUC/ARTICLE VI TCHR	Certificated	T03	05	P	A	1.00	42,738	1.00	45,909
EDN100/AA	7/24/2012	74487	ELEM TEACHER	Certificated	T03	05	P	A	1.00	53,279	1.00	45,909
EDN150/FA	7/24/2012	74140	SPEC ED TEACHER	Certificated	T03	05	P	A	1.00	46,011	1.00	45,909
EDN100/AA	7/24/2012	61546	ELEM TEACHER	Certificated	T02	05	P	A	1.00	48,351	1.00	42,509
EDN100/AA	7/24/2012	66172	SECONDARY TEACHER	Certificated	T03	05	P	A	1.00	41,794	1.00	45,909
EDN150/FA	7/24/2012	71670	SPEC ED TEACHER	Certificated	T03	05	T	A	1.00	40,157	1.00	45,909
EDN150/FA	7/24/2012	602460	GEN EDUC/ARTICLE VI TCHR	Certificated	T03	05	T	A			1.00	45,909
EDN150/FA	7/24/2012	602023	SPEC ED TEACHER	Certificated	T03	05	T	A			1.00	45,909
EDN100/AA	7/24/2012	60773	SECONDARY TEACHER	Certificated	T03	05	P	A	1.00	53,866	1.00	45,909
EDN150/FA	7/24/2012	63219	GEN EDUC/ARTICLE VI TCHR	Certificated	T03	05	P	A	1.00	65,715	1.00	45,909
EDN100/AA	7/24/2012	61146	ELEM TEACHER	Certificated	T02	05	P	A	1.00	43,048	1.00	42,509
EDN100/AA	7/24/2012	62381	SECONDARY TEACHER	Certificated	T03	05	P	A	1.00	74,436	1.00	45,909
EDN150/FA	7/24/2012	600206	GEN EDUC/ARTICLE VI TCHR	Certificated	T03	05	T	A			1.00	45,909
EDN100/AA	7/24/2012	61625	ELEM TEACHER	Certificated	T03	05	P	A	1.00	75,419	1.00	45,909
EDN100/AA	7/24/2012	72658	ELEM TEACHER	Certificated	T02	05	P	A	1.00	74,436	1.00	42,509

Department of Education
New Hires

Table 16

<u>Prog ID/Org</u>	<u>New Hire Effective Date</u>	<u>Position Number</u>	<u>Position Title</u>	<u>Exempt (Y/N)</u>	<u>SR Level</u>	<u>BU Code</u>	<u>T/P</u>	<u>MOF</u>	<u>Budgeted FTE</u>	<u>Budgeted Salary</u>	<u>Actual FTE</u>	<u>Actual Salary</u>
EDN100/AA	7/24/2012	64127	SECONDARY TEACHER	Certificated	T03	05	P	A	1.00	43,822	1.00	45,909
EDN100/AA	7/24/2012	63602	SECONDARY TEACHER	Certificated	T02	05	P	A	1.00	66,191	0.50	21,255
EDN100/AA	7/24/2012	600100	ELEM TEACHER	Certificated	T03	05	T	A			1.00	45,909
EDN100/AA	7/24/2012	66252	ELEM TEACHER	Certificated	T03	05	P	A	1.00	60,627	1.00	45,909
EDN150/FA	7/24/2012	68473	SPEC ED TEACHER	Certificated	T03	05	P	A	1.00	43,369	1.00	45,909
EDN100/AA	7/24/2012	61393	ELEM TEACHER	Certificated	T03	05	P	A			1.00	45,909
EDN100/AA	7/24/2012	67203	ELEM TEACHER	Certificated	T03	05	P	A	1.00	44,265	1.00	45,909
EDN100/AA	7/24/2012	69594	ELEM TEACHER	Certificated	T03	05	P	A	1.00	53,866	1.00	45,909
EDN100/AA	7/24/2012	71118	ELEM TEACHER	Certificated	T03	05	P	A	1.00	46,492	1.00	45,909
EDN100/AA	7/24/2012	68449	SECONDARY TEACHER	Certificated	T03	05	P	A	1.00	41,794	1.00	45,909
EDN100/AA	7/24/2012	60322	SECONDARY TEACHER	Certificated	T03	05	P	A	1.00	30,757	1.00	45,909
EDN100/AA	7/24/2012	63298	ELEM TEACHER	Certificated	T02	05	T	A	1.00	52,471	1.00	42,509
EDN100/AA	7/24/2012	68076	ELEM TEACHER	Certificated	T03	05	P	A	1.00	43,822	1.00	45,909
EDN100/AA	7/24/2012	65987	ELEM TEACHER	Certificated	T03	05	P	A	1.00	46,492	1.00	45,909
EDN100/AA	7/24/2012	601441	ELEM TEACHER	Certificated	T03	05	T	A			1.00	45,909
EDN150/FA	7/24/2012	603206	GEN EDUC/ARTICLE VI TCHR	Certificated	T03	05	T	A			1.00	45,909
EDN150/FA	7/24/2012	71961	SPEC ED TEACHER	Certificated	T03	05	P	A			1.00	45,909
EDN100/AA	7/24/2012	60154	ELEM TEACHER	Certificated	T03	05	P	A	1.00	66,191	1.00	45,909
EDN150/FA	7/24/2012	71189	SPEC ED TEACHER	Certificated	T02	05	P	A	1.00	40,157	1.00	42,509
EDN100/AA	7/24/2012	65135	ELEM TEACHER	Certificated	T03	05	P	A	1.00	40,577	1.00	45,909
EDN100/AA	7/24/2012	62702	ELEM TEACHER	Certificated	T03	05	T	A	1.00	45,138	1.00	45,909
EDN150/FA	7/24/2012	69386	SPEC ED TEACHER	Certificated	T02	05	P	A	1.00	46,011	1.00	42,509
EDN150/FA	7/24/2012	74566	SPEC ED TEACHER	Certificated	T02	05	P	A	1.00	46,011	1.00	42,509
EDN150/FA	7/24/2012	602340	SPEC ED TEACHER	Certificated	T03	05	T	A			1.00	45,909
EDN100/AA	7/24/2012	67141	ELEM TEACHER	Certificated	T03	05	P	A	1.00	54,531	1.00	45,909
EDN100/AA	7/24/2012	603510	SECONDARY TEACHER	Certificated	T02	05	T	A			1.00	42,509
EDN150/FA	7/24/2012	76031	SPEC ED TEACHER	Certificated	T02	05	P	A	1.00	47,851	1.00	32,222
EDN150/FA	7/24/2012	72159	SPEC ED TCHR/PRE-SCHOOL	Certificated	T02	05	P	A	1.00	54,860	1.00	42,509
EDN100/AA	7/24/2012	603542	ELEM TEACHER	Certificated	T02	05	T	A			1.00	42,509
EDN100/AA	7/24/2012	74251	ELEM TEACHER	Certificated	T03	05	T	A	1.00	52,296	1.00	45,909
EDN150/FA	7/24/2012	76150	GEN EDUC/ARTICLE VI TCHR	Certificated	T02	05	P	A	1.00	65,715	1.00	42,509
EDN100/AA	7/24/2012	69195	SECONDARY TEACHER	Certificated	T03	05	P	A	1.00	43,157	1.00	45,909
EDN100/AA	7/24/2012	69102	ELEM TEACHER	Certificated	T02	05	P	A	1.00	47,886	1.00	42,509
EDN100/AA	7/24/2012	66485	SECONDARY TEACHER	Certificated	T02	05	P	A	1.00	43,822	1.00	32,222
EDN100/AA	7/24/2012	72787	SECONDARY TEACHER	Certificated	T02	05	P	A	1.00	46,492	1.00	42,509
EDN100/AA	7/24/2012	73151	COUNSELOR	Certificated	T03	05	P	A	1.00	48,008	1.00	45,909
EDN100/AA	7/24/2012	65490	ELEM TEACHER	Certificated	T03	05	P	A	1.00	46,492	1.00	45,909
EDN100/AA	7/24/2012	603527	ELEM TEACHER	Certificated	T02	05	P	A			1.00	42,509
EDN100/AA	7/24/2012	603435	SECONDARY TEACHER	Certificated	T02	05	T	A			1.00	42,509
EDN100/AA	7/24/2012	68450	SECONDARY TEACHER	Certificated	T02	05	P	A	1.00	45,138	1.00	42,509
EDN150/FA	7/24/2012	68201	GEN EDUC/ARTICLE VI TCHR	Certificated	T02	05	P	A	1.00	49,924	1.00	42,509
EDN150/FA	7/24/2012	601255	SPEC ED TEACHER	Certificated	T03	05	T	A			1.00	45,909
EDN100/AA	7/24/2012	61424	ELEM TEACHER	Certificated	T03	05	P	A	1.00	70,222	1.00	45,909
EDN100/AA	7/24/2012	603574	ELEM TEACHER	Certificated	T02	05	T	A			1.00	42,509
EDN150/FA	7/24/2012	65101	SPEC ED TEACHER	Certificated	T03	05	P	A	1.00	42,602	1.00	45,909
EDN100/AA	7/24/2012	603154	SECONDARY TEACHER	Certificated	T03	05	T	A			1.00	45,909
EDN100/AA	7/24/2012	603405	ELEM TEACHER	Certificated	T02	05	T	A			0.50	21,255

<u>Prog ID/Org</u>	<u>New Hire Effective Date</u>	<u>Position Number</u>	<u>Position Title</u>	<u>Exempt (Y/N)</u>	<u>SR Level</u>	<u>BU Code</u>	<u>T/P</u>	<u>MOF</u>	<u>Budgeted FTE</u>	<u>Budgeted Salary</u>	<u>Actual FTE</u>	<u>Actual Salary</u>
EDN150/NB	7/24/2012	600606	DIST OFF TCHR	Certificated	T03	05	T	N			1.00	45,909
EDN100/AA	7/24/2012	66285	COUNSELOR	Certificated	T02	05	P	A	1.00	70,400	1.00	42,509
EDN150/FA	7/24/2012	72250	SPEC ED TEACHER	Certificated	T03	05	P	A	1.00	41,362	1.00	45,909
EDN100/AA	7/24/2012	62369	SECONDARY TEACHER	Certificated	T02	05	P	A	1.00	50,285	1.00	42,509
EDN150/FA	7/24/2012	73807	GEN EDUC/ARTICLE VI TCHR	Certificated	T03	05	P	A			1.00	45,909
EDN150/FA	7/24/2012	75890	GEN EDUC/ARTICLE VI TCHR	Certificated	T02	05	P	A	1.00	55,035	1.00	42,509
EDN100/AA	7/24/2012	71194	ELEM TEACHER	Certificated	T02	05	P	A	1.00	55,434	1.00	42,509
EDN100/AA	7/24/2012	602670	SECONDARY TEACHER	Certificated	T02	05	T	A			1.00	42,509
EDN100/AA	7/24/2012	60678	SECONDARY TEACHER	Certificated	T02	05	P	A	1.00	57,098	1.00	42,509
EDN100/AA	7/24/2012	76259	ELEM TEACHER	Certificated	T03	05	P	A	1.00	44,030	1.00	45,909
EDN100/BJ	7/24/2012	63205	SECONDARY TEACHER	Certificated	T02	05	T	A	1.00	66,191	1.00	42,509
EDN150/FA	7/24/2012	603291	SPEC ED TEACHER	Certificated	T03	05	T	A			1.00	45,909
EDN150/FA	7/24/2012	603286	GEN EDUC/ARTICLE VI TCHR	Certificated	T03	05	T	A			1.00	45,909
EDN100/AA	7/24/2012	61718	SECONDARY TEACHER	Certificated	T02	05	P	A	1.00	46,492	1.00	32,222
EDN100/AA	7/24/2012	64585	SECONDARY TEACHER	Certificated	T02	05	P	A	1.00	60,729	1.00	42,509
EDN150/FA	7/24/2012	601628	SPEC ED TEACHER	Certificated	T03	05	T	A			1.00	45,909
EDN100/AA	7/24/2012	64110	SECONDARY TEACHER	Certificated	T03	05	P	A	1.00	53,866	1.00	45,909
EDN150/FA	7/24/2012	65122	SPEC ED TEACHER	Certificated	T03	05	P	A	1.00	49,286	1.00	45,909
EDN100/AA	7/24/2012	67052	SECONDARY TEACHER	Certificated	T02	05	P	A	1.00	46,492	1.00	42,509
EDN100/AA	7/24/2012	60961	SECONDARY TEACHER	Certificated	T03	05	P	A	1.00	43,822	1.00	45,909
EDN100/AA	7/24/2012	62473	SECONDARY TEACHER	Certificated	T02	05	P	A	1.00	53,279	1.00	42,509
EDN150/FA	7/24/2012	63088	GEN EDUC/ARTICLE VI TCHR	Certificated	T02	05	P	A	1.00	43,713	1.00	42,509
EDN100/AA	7/24/2012	66631	SECONDARY TEACHER	Certificated	T02	05	P	A	1.00	57,098	1.00	42,509
EDN100/AA	7/24/2012	603384	ELEM TEACHER	Certificated	T03	05	T	A			1.00	45,909
EDN150/FA	7/24/2012	65744	SPEC ED TEACHER	Certificated	T03	05	P	A	1.00	46,011	1.00	45,909
EDN150/FA	7/24/2012	73558	SPEC ED TEACHER	Certificated	T03	05	P	A	1.00	43,575	1.00	45,909
EDN100/AA	7/24/2012	67258	ELEM TEACHER	Certificated	T03	05	P	A	1.00	60,449	1.00	45,909
EDN100/DB	7/24/2012	603450	ELEM TEACHER	Certificated	T03	05	T	N			1.00	45,909
EDN100/AA	7/24/2012	66897	ELEM TEACHER	Certificated	T03	05	P	A	1.00	48,351	1.00	45,909
EDN150/FA	7/24/2012	66247	SPEC ED TEACHER	Certificated	T02	05	P	A	1.00	46,011	1.00	42,509
EDN100/AA	7/24/2012	603506	SECONDARY TEACHER	Certificated	T02	05	T	A			1.00	49,991
EDN100/AA	7/24/2012	602685	ELEM TEACHER	Certificated	T02	05	T	A			1.00	42,509
EDN100/AA	7/24/2012	601587	COUNSELOR	Certificated	T03	05	T	A			1.00	45,909
EDN150/FA	7/24/2012	66030	SPEC ED TCHR/PRE-SCHOOL	Certificated	T03	05	P	A	1.00	43,575	1.00	45,909
EDN100/AA	7/24/2012	62897	SECONDARY TEACHER	Certificated	T02	05	P	A	1.00	43,822	1.00	32,222
EDN150/FA	7/24/2012	71313	GEN EDUC/ARTICLE VI TCHR	Certificated	T03	05	T	A	1.00	57,876	1.00	45,909
EDN100/AA	7/24/2012	74242	SECONDARY TEACHER	Certificated	T02	05	P	A	1.00	64,264	1.00	42,509
EDN100/AA	7/24/2012	66343	ELEM TEACHER	Certificated	T02	05	P	A	1.00	68,177	1.00	42,509
EDN100/AA	7/24/2012	601717	SECONDARY TEACHER	Certificated	T07	05	T	A			1.00	54,741
EDN150/SA	7/24/2012	46662	SPEECH PATHOLOGIST II	Y	SR18	13	P	A	1.00	54,027	1.00	38,988
EDN150/FA	7/24/2012	603183	SPEC ED TEACHER	Certificated	T02	05	T	A			1.00	42,509
EDN100/AA	7/24/2012	66752	SECONDARY TEACHER	Certificated	T02	05	P	A	1.00	43,822	1.00	42,509
EDN150/FA	7/24/2012	62860	GEN EDUC/ARTICLE VI TCHR	Certificated	T02	05	T	A			1.00	42,509
EDN150/FA	7/24/2012	603290	SPEC ED TEACHER	Certificated	T02	05	T	A			1.00	42,509
EDN150/FA	7/24/2012	64365	GEN EDUC/ARTICLE VI TCHR	Certificated	T03	05	P	A	1.00	47,133	1.00	45,909
EDN100/AA	7/24/2012	72298	ELEM TEACHER	Certificated	T03	05	P	A	1.00	65,247	1.00	45,909
EDN150/FA	7/24/2012	64047	SPEC ED TEACHER	Certificated	T03	05	P	A	1.00	54,908	1.00	45,909

<u>Prog ID/Org</u>	<u>New Hire Effective Date</u>	<u>Position Number</u>	<u>Position Title</u>	<u>Exempt (Y/N)</u>	<u>SR Level</u>	<u>BU Code</u>	<u>T/P</u>	<u>MOF</u>	<u>Budgeted FTE</u>	<u>Budgeted Salary</u>	<u>Actual FTE</u>	<u>Actual Salary</u>
EDN150/FA	7/24/2012	73570	SPEC ED TEACHER	Certificated	T02	05	P	A	1.00	49,286	1.00	42,509
EDN100/BJ	7/24/2012	76042	SECONDARY TEACHER	Certificated	T02	05	P	A	1.00	40,577	1.00	32,222
EDN100/AA	7/24/2012	68965	ELEM TEACHER	Certificated	T03	05	P	A	1.00	43,822	1.00	45,909
EDN150/FA	7/24/2012	62714	SPEC ED TEACHER	Certificated	T02	05	P	A	1.00	49,387	1.00	32,222
EDN100/AA	7/24/2012	600113	ELEM TEACHER	Certificated	T03	05	T	A			1.00	45,909
EDN100/AA	7/24/2012	60672	SECONDARY TEACHER	Certificated	T03	05	P	A	1.00	45,138	1.00	45,909
EDN100/AA	7/24/2012	67629	ELEM TEACHER	Certificated	T02	05	P	A	1.00	40,577	1.00	42,509
EDN150/FA	7/24/2012	64149	SPEC ED TEACHER	Certificated	T03	05	P	A	1.00	43,369	1.00	45,909
EDN100/AA	7/24/2012	29388	SCHOOL HEALTH AIDE	N	SR09	03	P	A	1.00	21,131	1.00	13,867
EDN150/FA	7/24/2012	603477	SPEC ED TEACHER	Certificated	T03	05	T	A			1.00	45,909
EDN150/SA	7/24/2012	800335	SPEECH PATHOLOGIST II	Y	SR18	13	P	A	1.00	51,891	1.00	38,988
EDN150/FA	7/24/2012	69320	SPEC ED TEACHER	Certificated	T02	05	P	A	1.00	40,157	1.00	32,222
EDN150/SA	7/24/2012	48826	SPEECH PATHOLOGIST II	Y	SR18	13	P	A	1.00	54,027	1.00	38,988
EDN100/AA	7/24/2012	66626	SECONDARY TEACHER	Certificated	T03	05	P	A	1.00	48,351	1.00	45,909
EDN150/FA	7/24/2012	73248	SPEC ED TEACHER	Certificated	T02	05	P	A	1.00	46,011	1.00	42,509
EDN150/FA	7/24/2012	74334	SPEC ED TEACHER	Certificated	T02	05	P	A	1.00	37,747	1.00	42,509
EDN150/FA	7/24/2012	74335	SPEC ED TEACHER	Certificated	T02	05	P	A	1.00	37,747	1.00	42,509
EDN150/FA	7/24/2012	68791	SPEC ED TEACHER	Certificated	T02	05	P	A	1.00	46,157	1.00	42,509
EDN150/FA	7/24/2012	73673	SPEC ED TEACHER	Certificated	T02	05	T	A	1.00	41,362	1.00	42,509
EDN100/BB	7/24/2012	68441	SECONDARY TEACHER	Certificated	T02	05	P	A	1.00	51,228	1.00	42,509
EDN150/FA	7/24/2012	603315	SPEC ED TEACHER	Certificated	T03	05	T	A			1.00	45,909
EDN150/SA	7/24/2012	56363	SPEECH PATHOLOGIST II	Y	SR18	13	P	A	1.00	54,027	1.00	38,988
EDN100/AA	7/24/2012	603508	ELEM TEACHER	Certificated	T03	05	T	A			1.00	45,909
EDN150/NB	7/24/2012	600815	DIST OFF TCHR	Certificated	T03	05	T	N			1.00	45,909
EDN150/SA	7/24/2012	33115	SPEECH PATHOLOGIST IV	Y	SR22	13	P	A	1.00	63,874	1.00	45,576
EDN100/BJ	7/24/2012	62703	SPECIAL SCH TEACHER	Certificated	T02	05	T	A	1.00	43,597	1.00	32,222
EDN100/AA	7/24/2012	602965	SECONDARY TEACHER	Certificated	T02	05	T	A			1.00	42,509
EDN150/FA	7/24/2012	75848	SPEC ED TEACHER	Certificated	T02	05	T	A	1.00	40,157	1.00	42,509
EDN100/AA	7/24/2012	602077	SECONDARY TEACHER	Certificated	T02	05	P	A			1.00	42,509
EDN100/AA	7/24/2012	68580	ELEM TEACHER	Certificated	T02	05	P	A	1.00	40,577	1.00	32,222
EDN100/AA	7/24/2012	72190	ELEM TEACHER	Certificated	T02	05	P	A	1.00	48,351	1.00	32,222
EDN100/AA	7/24/2012	65275	SECONDARY TEACHER	Certificated	T02	05	P	A	1.00	65,247	1.00	32,222
EDN100/AA	7/24/2012	602586	SECONDARY TEACHER	Certificated	T02	05	T	A			1.00	32,222
EDN100/AA	7/24/2012	68107	SECONDARY TEACHER	Certificated	T02	05	P	A	1.00	62,391	1.00	32,222
EDN100/AA	7/24/2012	63785	SECONDARY TEACHER	Certificated	T02	05	T	A	1.00	56,053	1.00	32,222
EDN100/AA	7/24/2012	61427	ELEM TEACHER	Certificated	T02	05	P	A	1.00	41,794	1.00	32,222
EDN150/FA	7/24/2012	69052	SPEC ED TEACHER	Certificated	T02	05	P	A	1.00	47,851	1.00	32,222
EDN100/AA	7/24/2012	603453	ELEM TEACHER	Certificated	T02	05	T	A			1.00	32,222
EDN100/AA	7/24/2012	602076	ELEM TEACHER	Certificated	T02	05	P	A			1.00	32,222
EDN100/AA	7/24/2012	60262	ELEM TEACHER	Certificated	T02	05	T	A	1.00	45,138	1.00	32,222
EDN100/AA	7/24/2012	69590	ELEM TEACHER	Certificated	T02	05	P	A	1.00	52,296	1.00	32,222
EDN150/FA	7/24/2012	72410	SPEC ED TEACHER	Certificated	T02	05	P	A	1.00	55,833	1.00	32,222
EDN100/AA	7/24/2012	602930	ELEM TEACHER	Certificated	T02	05	T	A			1.00	32,222
EDN150/FA	7/24/2012	69083	SPEC ED TEACHER	Certificated	T02	05	P	A	1.00	37,747	1.00	32,222
EDN100/AA	7/24/2012	62323	SECONDARY TEACHER	Certificated	T02	05	P	A	1.00	74,436	1.00	32,222
EDN150/FA	7/24/2012	600535	SPEC ED TEACHER	Certificated	T02	05	T	A			1.00	32,222
EDN100/AA	7/24/2012	603396	SECONDARY TEACHER	Certificated	T02	05	T	A			1.00	32,222

<u>Prog ID/Org</u>	<u>New Hire Effective Date</u>	<u>Position Number</u>	<u>Position Title</u>	<u>Exempt (Y/N)</u>	<u>SR Level</u>	<u>BU Code</u>	<u>T/P</u>	<u>MOF</u>	<u>Budgeted FTE</u>	<u>Budgeted Salary</u>	<u>Actual FTE</u>	<u>Actual Salary</u>
EDN100/AA	7/24/2012	65051	ELEM TEACHER	Certificated	T02	05	P	A	1.00	41,794	1.00	32,222
EDN150/FA	7/24/2012	64006	SPEC ED TEACHER	Certificated	T02	05	P	A	1.00	49,286	1.00	32,222
EDN100/AA	7/24/2012	602687	SECONDARY TEACHER	Certificated	T02	05	T	A			1.00	32,222
EDN150/FA	7/24/2012	61817	SPEC ED TEACHER	Certificated	T02	05	P	A	1.00	40,157	1.00	32,222
EDN100/AA	7/24/2012	61765	ELEM TEACHER	Certificated	T02	05	T	A	1.00	49,904	1.00	32,222
EDN100/AA	7/24/2012	67298	SECONDARY TEACHER	Certificated	T02	05	P	A	1.00	43,822	1.00	32,222
EDN100/AA	7/24/2012	68618	SECONDARY TEACHER	Certificated	T02	05	P	A	1.00	38,142	1.00	42,509
EDN150/FA	7/24/2012	72377	SPEC ED TEACHER	Certificated	T02	05	P	A	1.00	46,011	1.00	42,509
EDN150/FA	7/24/2012	74194	SPEC ED TEACHER	Certificated	T02	05	P	A	1.00	40,157	1.00	42,509
EDN150/FA	7/24/2012	74070	SPEC ED TEACHER	Certificated	T02	05	P	A	1.00	30,536	1.00	32,222
EDN150/FA	7/24/2012	63102	SPEC ED TEACHER	Certificated	T02	05	P	A	1.00	69,496	1.00	32,222
EDN100/AA	7/24/2012	603080	SECONDARY TEACHER	Certificated	T02	05	T	A			1.00	32,222
EDN100/AA	7/24/2012	601479	ELEM TEACHER	Certificated	T02	05	T	A			1.00	32,222
EDN150/FA	7/24/2012	74327	SPEC ED TEACHER	Certificated	T02	05	P	A	1.00	43,369	1.00	32,222
EDN100/AA	7/24/2012	75034	SECONDARY TEACHER	Certificated	T02	05	T	A	1.00	38,142	1.00	32,222
EDN100/AA	7/24/2012	62730	ELEM TEACHER	Certificated	T02	05	T	A	1.00	43,822	1.00	32,222
EDN100/AA	7/24/2012	600500	SECONDARY TEACHER	Certificated	T02	05	T	A			1.00	32,222
EDN100/AA	7/24/2012	71999	ELEM TEACHER	Certificated	T02	05	P	A	1.00	58,810	1.00	32,222
EDN100/AA	7/24/2012	602425	ELEM TEACHER	Certificated	T02	05	T	A			1.00	32,222
EDN100/BJ	7/24/2012	603177	SECONDARY TEACHER	Certificated	T02	05	T	A			1.00	32,222
EDN150/FA	7/24/2012	73368	SPEC ED TEACHER	Certificated	T02	05	P	A	1.00	46,011	1.00	32,222
EDN100/AA	7/24/2012	71137	ELEM TEACHER	Certificated	T02	05	P	A	1.00	46,492	1.00	32,222
EDN100/AA	7/24/2012	61649	SECONDARY TEACHER	Certificated	T02	05	P	A	0.50	28,549	1.00	32,222
EDN100/AA	7/24/2012	62727	SECONDARY TEACHER	Certificated	T02	05	P	A	1.00	48,351	1.00	32,222
EDN150/FA	7/24/2012	603230	GEN EDUC/ARTICLE VI TCHR	Certificated	T02	05	T	A			1.00	32,222
EDN100/AA	7/24/2012	601500	SECONDARY TEACHER	Certificated	T02	05	T	A			1.00	32,222
EDN150/FA	7/24/2012	64165	GEN EDUC/ARTICLE VI TCHR	Certificated	T02	05	P	A	1.00	43,507	1.00	32,222
EDN100/AA	7/24/2012	68120	ELEM TEACHER	Certificated	T02	05	P	A	1.00	43,822	1.00	32,222
EDN100/AA	7/24/2012	61658	SECONDARY TEACHER	Certificated	T02	05	P	A	1.00	74,436	1.00	32,222
EDN100/AA	7/24/2012	67342	SECONDARY TEACHER	Certificated	T02	05	P	A	1.00	58,810	1.00	32,222
EDN150/FA	7/24/2012	72342	SPEC ED TEACHER	Certificated	T02	05	P	A	1.00	46,011	1.00	32,222
EDN150/FA	7/24/2012	74115	SPEC ED TEACHER	Certificated	T02	05	P	A	1.00	50,737	1.00	32,222
EDN100/AA	7/24/2012	64207	SECONDARY TEACHER	Certificated	T02	05	P	A	1.00	51,268	1.00	32,222
EDN100/AA	7/24/2012	62268	SECONDARY TEACHER	Certificated	T02	05	P	A	1.00	70,222	1.00	32,222
EDN100/AA	7/24/2012	72188	ELEM TEACHER	Certificated	T02	05	P	A	1.00	47,886	1.00	32,222
EDN100/AA	7/24/2012	73597	SECONDARY TEACHER	Certificated	T02	05	T	A	1.00	30,757	1.00	42,509
EDN150/FA	7/24/2012	602347	GEN EDUC/ARTICLE VI TCHR	Certificated	T02	05	T	A			1.00	32,222
EDN100/AA	7/24/2012	66963	ELEM TEACHER	Certificated	T02	05	P	A	1.00	65,247	1.00	32,222
EDN150/FA	7/24/2012	72267	SPEC ED TEACHER	Certificated	T02	05	P	A	1.00	44,671	1.00	32,222
EDN150/FA	7/24/2012	75658	SPEC ED TEACHER	Certificated	T02	05	P	A	1.00	57,480	1.00	32,222
EDN100/AA	7/24/2012	62368	SECONDARY TEACHER	Certificated	T02	05	P	A	1.00	46,492	1.00	32,222
EDN100/BJ	7/24/2012	73022	SECONDARY TEACHER	Certificated	T02	05	P	A			1.00	32,222
EDN100/AA	7/24/2012	71523	ELEM TEACHER	Certificated	T02	05	P	A	1.00	40,577	1.00	32,222
EDN150/FA	7/24/2012	64191	SPEC ED TEACHER	Certificated	T02	05	P	A	1.00	69,496	1.00	42,509
EDN150/FA	7/24/2012	602288	SPEC ED TEACHER	Certificated	T02	05	T	A			1.00	32,222
EDN100/AA	7/24/2012	602929	ELEM TEACHER	Certificated	T02	05	T	A			1.00	32,222
EDN150/FA	7/24/2012	75907	GEN EDUC/ARTICLE VI TCHR	Certificated	T02	05	P	A	1.00	37,867	1.00	32,222

Department of Education
New Hires

Table 16

<u>Prog ID/Org</u>	<u>New Hire Effective Date</u>	<u>Position Number</u>	<u>Position Title</u>	<u>Exempt (Y/N)</u>	<u>SR Level</u>	<u>BU Code</u>	<u>T/P</u>	<u>MOF</u>	<u>Budgeted FTE</u>	<u>Budgeted Salary</u>	<u>Actual FTE</u>	<u>Actual Salary</u>
EDN100/AA	7/24/2012	68993	SECONDARY TEACHER	Certificated	T02	05	P	A	1.00	44,030	1.00	32,222
EDN150/FA	7/24/2012	71551	SPEC ED TEACHER	Certificated	T02	05	P	A	1.00	40,157	1.00	42,509
EDN100/AA	7/24/2012	63539	SECONDARY TEACHER	Certificated	T02	05	P	A	1.00	68,177	1.00	42,509
EDN100/AA	7/24/2012	72022	SECONDARY TEACHER	Certificated	T02	05	P	A	1.00	38,142	1.00	32,222
EDN100/AA	7/24/2012	73972	ELEM TEACHER	Certificated	T02	05	T	A	1.00	43,822	1.00	32,222
EDN150/FA	7/24/2012	74843	GEN EDUC/ARTICLE VI TCHR	Certificated	T02	05	P	A	1.00	41,494	1.00	32,222
EDN100/AA	7/24/2012	29449	SCHOOL HEALTH AIDE	N	SR09	03	P	A	1.00	19,575	1.00	13,867
EDN150/FA	7/24/2012	76154	SPEC ED TEACHER	Certificated	T02	05	P	A	1.00	40,157	1.00	32,222
EDN100/AA	7/24/2012	802580	DP USER SUPPORT TECH II	N	SR15	03	T	A			0.50	8,764
EDN150/FA	7/24/2012	73293	SPEC ED TEACHER	Certificated	T02	05	T	A	1.00	30,439	1.00	42,509
EDN150/SA	7/24/2012	56191	SPEECH PATHOLOGIST IV	Y	SR22	13	P	A	1.00	51,891	1.00	45,576
EDN100/AA	7/24/2012	72666	SECONDARY TEACHER	Certificated	T02	05	P	A	1.00	46,492	1.00	32,222
EDN150/FA	7/24/2012	603273	GEN EDUC/ARTICLE VI TCHR	Certificated	T03	05	T	A			1.00	45,909
EDN150/YC	7/24/2012	800470	SCHOOL PSYCHOLOGIST	Y	SR24	13	P	A	1.00	54,194	1.00	26,644
EDN150/SA	7/24/2012	33038	SPEECH PATHOLOGIST II	Y	SR18	13	P	A	1.00	54,027	1.00	38,988
EDN150/FA	7/25/2012	801888	EDUC ASST III	Y	SR12	03	T	A			1.00	25,030
EDN100/AA	7/25/2012	603401	SECONDARY TEACHER	Certificated	T03	05	T	A			1.00	45,909
EDN200/GP	7/25/2012	69702	DOE DECISION SUPP SPEC I	Certificated	E06	06	P	A			1.00	73,921
EDN100/AA	7/25/2012	61394	COUNSELOR	Certificated	T03	05	P	A	1.00	79,170	1.00	45,909
EDN150/YG	7/25/2012	802378	EDUC ASST III	Y	SR12	03	T	A			1.00	25,030
EDN150/FA	7/25/2012	61247	GEN EDUC/ARTICLE VI TCHR	Certificated	T02	05	T	A			1.00	42,509
EDN100/AA	7/25/2012	29306	SCHOOL HEALTH AIDE	N	SR09	03	P	A	1.00	20,342	1.00	13,867
EDN150/YG	7/25/2012	801720	EDUC ASST I	Y	SR08	03	T	A			1.00	13,327
EDN150/FA	7/25/2012	52592	EDUC ASST III	Y	SR12	03	T	A	0.75	18,237	0.75	18,773
EDN150/YG	7/25/2012	801719	EDUC ASST I	Y	SR08	03	T	A			1.00	13,327
EDN150/FA	7/25/2012	800195	EDUC ASST III	Y	SR12	03	T	A	1.00	24,314	1.00	25,030
EDN100/AA	7/25/2012	600222	SECONDARY TEACHER	Certificated	T02	05	T	A			1.00	32,222
EDN100/AA	7/25/2012	64759	SECONDARY TEACHER	Certificated	T02	05	P	A	1.00	43,048	1.00	42,509
EDN150/YG	7/25/2012	801705	EDUC ASST I	Y	SR08	03	T	A			1.00	13,327
EDN100/AA	7/25/2012	802575	SCHOOL SECURITY ATTENDANT	N	SR07	03	T	A			1.00	12,798
EDN100/AA	7/25/2012	30606	SCHOOL SECURITY ATTENDANT	N	SR07	03	P	A	1.00	30,506	1.00	12,798
EDN150/FA	7/25/2012	52626	EDUC ASST II	Y	SR10	03	P	A	0.75	20,495	0.75	17,348
EDN150/FA	7/25/2012	56679	EDUC ASST I	Y	SR08	03	P	A	0.75	18,237	0.75	9,995
EDN100/AA	7/25/2012	61218	ELEM TEACHER	Certificated	T02	05	P	A	1.00	45,138	1.00	42,509
EDN150/FA	7/25/2012	56717	EDUC ASST III	Y	SR12	03	P	A	0.50	13,124	0.50	12,515
EDN100/AA	7/25/2012	67348	ELEM TEACHER	Certificated	T02	05	T	A	1.00	58,810	1.00	42,509
EDN150/NB	7/25/2012	800177	EDUC ASST II	Y	SR10	03	T	N			1.00	23,130
EDN100/AA	7/25/2012	800736	SCHOOL SECURITY ATTENDANT	N	SR07	03	T	A			1.00	12,798
EDN150/YG	7/25/2012	801718	EDUC ASST I	Y	SR08	03	T	A			1.00	13,327
EDN100/AA	7/25/2012	72106	SECONDARY TEACHER	Certificated	T03	05	P	A	1.00	43,822	1.00	45,909
EDN150/FA	7/25/2012	802070	EDUC ASST II	Y	SR10	03	T	A			0.75	17,348
EDN150/YG	7/25/2012	802377	EDUC ASST II	Y	SR10	03	T	A			1.00	23,130
EDN100/AA	7/25/2012	54879	OFFICE ASSISTANT III	N	SR08	03	T	A	0.50	12,834	0.50	6,664
EDN150/FA	7/25/2012	56746	EDUC ASST I	Y	SR08	03	P	A	1.00	26,248	0.75	16,043
EDN150/YG	7/25/2012	801704	EDUC ASST I	Y	SR08	03	T	A			1.00	13,327
EDN150/FA	7/25/2012	66324	SPEC ED TEACHER	Certificated	T02	05	P	A	1.00	37,747	1.00	32,222
EDN150/YC	7/25/2012	59637	SCHOOL PSYCHOLOGIST	Y	SR24	13	T	A	1.00	47,360	1.00	26,644

<u>Prog ID/Org</u>	<u>New Hire Effective Date</u>	<u>Position Number</u>	<u>Position Title</u>	<u>Exempt (Y/N)</u>	<u>SR Level</u>	<u>BU Code</u>	<u>T/P</u>	<u>MOF</u>	<u>Budgeted FTE</u>	<u>Budgeted Salary</u>	<u>Actual FTE</u>	<u>Actual Salary</u>
EDN150/YG	7/25/2012	801941	SCHOOL PSYCHOLOGIST	Y	SR24	13	T	A			1.00	26,644
EDN150/SA	7/26/2012	801136	PHYSICAL THERAPIST IV	N	SR22	13	P	A	1.00	51,759	1.00	23,663
EDN100/AA	7/26/2012	29319	SCHOOL HEALTH AIDE	N	SR09	03	P	A	1.00	18,793	1.00	13,867
EDN150/YC	7/26/2012	59148	BEHAVIORAL HLTH SPCLT III	N	SR20	13	P	A	1.00	42,066	1.00	21,881
EDN400/MD	7/27/2012	59513	CAFETERIA HELPER	N	BC02	01	T	B			0.50	16,614
EDN400/MD	7/27/2012	42811	CAFETERIA HELPER	N	BC02	01	T	B			0.50	16,614
EDN400/MD	7/27/2012	58837	FOOD SERVICES DRIVER	N	BC03	01	T	B			1.00	34,164
EDN400/MD	7/27/2012	58619	CAFETERIA HELPER	N	BC02	01	T	B	0.50	5,192	0.50	8,629
EDN150/FA	7/27/2012	75694	SPEC ED TEACHER	Certificated	T02	05	T	A	1.00	30,439	1.00	49,991
EDN400/MD	7/27/2012	28010	CAFETERIA HELPER	N	BC02	01	T	B			0.50	16,614
EDN150/YC	7/27/2012	58084	HUMAN SVCS PROF IV	N	SR22	13	P	A	1.00	42,066	1.00	23,663
EDN150/FA	7/30/2012	802348	EDUC ASST I	Y	SR08	03	T	A			1.00	13,327
EDN100/AA	7/30/2012	72276	ELEM TEACHER	Certificated	T02	05	P	A	1.00	47,474	1.00	42,509
EDN400/MD	7/30/2012	801267	CAFETERIA HELPER	N	BC02	01	T	B			0.50	16,614
EDN100/AA	7/30/2012	75075	SECONDARY TEACHER	Certificated	T02	05	P	A	1.00	58,316	1.00	42,509
EDN400/MD	7/30/2012	34170	CAFETERIA HELPER	N	BC02	01	T	B			0.50	8,629
EDN150/FA	7/30/2012	801906	EDUC ASST I	Y	SR08	03	T	A			0.50	6,664
EDN150/NB	7/30/2012	802223	EDUC ASST I	Y	SR08	03	T	N			1.00	13,327
EDN150/FA	7/30/2012	64954	SPEC ED TEACHER	Certificated	T03	05	P	A	1.00	40,157	1.00	45,909
EDN100/AA	7/30/2012	37422	OFFICE ASSISTANT III	N	SR08	03	P	A	1.00	28,836	1.00	13,327
EDN100/AA	7/30/2012	62471	SECONDARY TEACHER	Certificated	T02	05	P	A	1.00	44,030	1.00	42,509
EDN150/YC	7/30/2012	58514	BEHAVIORAL HLTH SPCLT III	N	SR20	13	T	A	1.00	43,761	1.00	21,881
EDN100/AA	7/30/2012	603468	ELEM TEACHER	Certificated	T02	05	T	A			0.50	21,255
EDN150/FA	7/30/2012	74810	SPEC ED TEACHER	Certificated	T02	05	P	A	1.00	57,480	1.00	32,222
EDN100/AA	7/30/2012	800717	OFFICE ASSISTANT III	N	SR08	03	T	A			1.00	13,327
EDN150/FA	7/30/2012	74909	SPEC ED TEACHER	Certificated	T02	05	P	A	1.00	43,369	1.00	32,222
EDN150/FA	7/30/2012	57352	EDUC ASST I	Y	SR08	03	T	A	0.75	18,237	0.75	9,995
EDN150/FA	7/30/2012	69766	GEN EDUC/ARTICLE VI TCHR	Certificated	T02	05	P	A	1.00	45,788	1.00	42,509
EDN150/FA	7/30/2012	52625	EDUC ASST I	Y	SR08	03	P	A	0.50	12,158	0.50	6,664
EDN100/AA	7/30/2012	600426	10-MO STUDENT SVCS COORD	Certificated	T03	05	T	A			1.00	45,909
EDN150/FA	7/30/2012	73335	SPEC ED TEACHER	Certificated	T02	05	P	A	1.00	40,157	1.00	32,222
EDN150/FA	7/30/2012	802353	EDUC ASST III	Y	SR12	03	T	A			1.00	25,030
EDN150/FA	7/30/2012	61624	SPEC ED TEACHER	Certificated	T03	05	P	A	1.00	44,671	1.00	45,909
EDN400/MD	7/30/2012	802417	CAFETERIA HELPER	N	BC02	01	T	B			0.50	16,614
EDN100/AA	7/30/2012	61573	ELEM TEACHER	Certificated	T02	05	P	A	1.00	43,822	1.00	42,509
EDN150/FA	7/30/2012	76122	GEN EDUC/ARTICLE VI TCHR	Certificated	T03	05	P	A	1.00	49,443	1.00	45,909
EDN100/AA	7/30/2012	603403	SECONDARY TEACHER	Certificated	T02	05	T	A			1.00	42,509
EDN100/AA	7/30/2012	61785	ELEM TEACHER	Certificated	T03	05	P	A	1.00	75,419	1.00	45,909
EDN100/AA	7/30/2012	601427	SECONDARY TEACHER	Certificated	T03	05	T	A			1.00	45,909
EDN150/FA	7/30/2012	62110	SPEC ED TEACHER	Certificated	T02	05	P	A	1.00	30,439	1.00	32,222
EDN150/FA	7/30/2012	63273	GEN EDUC/ARTICLE VI TCHR	Certificated	T02	05	T	A	1.00	46,605	1.00	42,509
EDN100/AA	7/30/2012	603526	ELEM TEACHER	Certificated	T03	05	T	A			1.00	45,909
EDN150/FA	7/30/2012	801892	EDUC ASST I	Y	SR08	03	P	A			0.50	6,664
EDN100/AA	7/30/2012	64261	SECONDARY TEACHER	Certificated	T03	05	T	A	1.00	57,098	1.00	45,909
EDN150/FA	7/30/2012	54726	EDUC ASST I	Y	SR08	03	P	A	1.00	25,266	1.00	13,327
EDN150/FA	7/30/2012	71738	SPEC ED TEACHER	Certificated	T02	05	T	A	1.00	40,157	1.00	32,222
EDN150/FA	7/30/2012	63401	SPEC ED TEACHER	Certificated	T02	05	P	A	1.00	37,747	1.00	32,222

Department of Education
New Hires

Table 16

<u>Prog ID/Org</u>	<u>New Hire Effective Date</u>	<u>Position Number</u>	<u>Position Title</u>	<u>Exempt (Y/N)</u>	<u>SR Level</u>	<u>BU Code</u>	<u>T/P</u>	<u>MOF</u>	<u>Budgeted FTE</u>	<u>Budgeted Salary</u>	<u>Actual FTE</u>	<u>Actual Salary</u>
EDN100/AA	7/30/2012	61498	ELEM TEACHER	Certificated	T02	05	P	A	1.00	40,577	1.00	42,509
EDN100/AA	7/30/2012	61035	SECONDARY TEACHER	Certificated	T02	05	P	A	1.00	48,351	1.00	32,222
EDN150/FA	7/30/2012	800045	EDUC ASST I	Y	SR08	03	P	A			0.75	9,995
EDN150/FA	7/30/2012	60662	SPEC ED TEACHER	Certificated	T03	05	P	A	1.00	30,439	1.00	45,909
EDN100/BJ	7/30/2012	73105	SECONDARY TEACHER	Certificated	T02	05	T	A			1.00	42,509
EDN150/FA	7/30/2012	601716	SPEC ED TEACHER	Certificated	T03	05	T	A			1.00	45,909
EDN150/SA	7/30/2012	56287	SPEECH PATHOLOGIST II	Y	SR18	13	P	A	1.00	58,715	1.00	38,988
EDN100/AA	7/30/2012	76034	SECONDARY TEACHER	Certificated	T03	05	P	A	1.00	64,264	1.00	45,909
EDN100/AA	7/30/2012	64067	SECONDARY TEACHER	Certificated	T03	05	P	A	1.00	43,048	1.00	45,909
EDN100/AA	7/30/2012	66079	ELEM TEACHER	Certificated	T02	05	P	A	1.00	46,492	1.00	42,509
EDN100/AA	7/30/2012	61067	LIBRARIAN	Certificated	T02	05	T	A	1.00	56,382	1.00	32,222
EDN100/AA	7/30/2012	64301	SECONDARY TEACHER	Certificated	T02	05	P	A	1.00	43,822	1.00	49,991
EDN100/BJ	7/30/2012	69479	SECONDARY TEACHER	Certificated	T02	05	T	A			1.00	42,509
EDN100/AA	7/30/2012	802683	SCHOOL SECURITY ATTENDANT	N	SR07	03	T	A			1.00	12,798
EDN100/BS	7/30/2012	73395	ROTC INSTRUCTOR	Certificated	ROTC	05	T	A	1.00	66,578	1.00	86,883
EDN100/AA	7/30/2012	63139	SECONDARY TEACHER	Certificated	T02	05	P	A	1.00	54,565	1.00	32,222
EDN100/AA	7/30/2012	802689	DP USER SUPPORT TECH II	N	SR15	03	T	A			1.00	17,528
EDN100/BM	7/30/2012	52450	ATHLETIC HLTH CARE TRAINER	Y	SR22	13	P	A	1.00	42,073	1.00	23,663
EDN100/AA	7/31/2012	72361	SECONDARY TEACHER	Certificated	T03	05	P	A	1.00	46,492	1.00	45,909
EDN150/FA	7/31/2012	58936	EDUC ASST III	Y	SR12	03	P	A	1.00	27,326	0.75	18,773
EDN150/FA	7/31/2012	74183	SPEC ED TEACHER	Certificated	T02	05	P	A	1.00	42,602	1.00	42,509
EDN100/AA	8/1/2012	802630	SCHOOL SECURITY ATTENDANT	N	SR07	03	T	A			1.00	12,798
EDN150/NB	8/1/2012	802474	EDUC ASST II	Y	SR10	03	T	N			1.00	23,130
EDN150/NB	8/1/2012	600605	DIST OFF TCHR	Certificated	T02	05	T	N			1.00	32,222
EDN100/AA	8/1/2012	74475	SECONDARY TEACHER	Certificated	T02	05	P	A	1.00	75,419	1.00	42,509
EDN100/AA	8/1/2012	29330	SCHOOL HEALTH AIDE	N	SR09	03	P	A	1.00	17,401	1.00	13,867
EDN100/AA	8/1/2012	72316	SECONDARY TEACHER	Certificated	T02	05	P	A	1.00	66,191	1.00	32,222
EDN150/FA	8/1/2012	73471	SPEC ED TEACHER	Certificated	T02	05	P	A	1.00	54,939	1.00	32,222
EDN150/SA	8/1/2012	56278	SPEECH PATHOLOGIST II	Y	SR18	13	P	A	1.00	54,027	1.00	38,988
EDN150/FA	8/1/2012	69918	GEN EDUC/ARTICLE VI TCHR	Certificated	T01	05	P	A	1.00	44,813	1.00	34,883
EDN150/FA	8/2/2012	58931	EDUC ASST I	Y	SR08	03	T	A	1.00	27,326	0.50	6,664
EDN150/FA	8/2/2012	76116	GEN EDUC/ARTICLE VI TCHR	Certificated	T03	05	T	A	1.00	47,366	1.00	45,909
EDN400/MD	8/2/2012	52479	SCHOOL COOK II	N	BC06	01	P	B	1.00	12,012	1.00	19,958
EDN100/AA	8/2/2012	802685	EDUC ASST I	Y	SR08	03	T	A			0.50	6,664
EDN400/MD	8/2/2012	801268	CAFETERIA HELPER	N	BC02	01	T	B			0.50	8,629
EDN100/AA	8/2/2012	62797	ELEM TEACHER	Certificated	T02	05	T	A	1.00	41,559	1.00	42,509
EDN100/AA	8/2/2012	71231	ELEM TEACHER	Certificated	T02	05	P	A	1.00	51,296	1.00	42,509
EDN100/AA	8/3/2012	64009	ELEM TEACHER	Certificated	T02	05	P	A	1.00	55,482	1.00	42,509
EDN150/FA	8/3/2012	602393	SPEC ED TEACHER	Certificated	T02	05	T	A			1.00	32,222
EDN400/MB	8/3/2012	19126	PRGM SPCLT V	N	SR24	13	T	N	1.00	51,312	1.00	57,708
EDN150/FA	8/6/2012	66674	SPEC ED TEACHER	Certificated	T02	05	T	A	1.00	40,157	1.00	37,893
EDN100/AA	8/6/2012	600319	ELEM TEACHER	Certificated	T03	05	T	A			1.00	45,909
EDN150/FA	8/6/2012	57132	EDUC ASST I	Y	SR08	03	T	A	0.50	14,193	0.50	6,664
EDN100/AA	8/6/2012	69147	SECONDARY TEACHER	Certificated	T02	05	P	A	1.00	38,142	1.00	32,222
EDN100/AA	8/6/2012	72693	SECONDARY TEACHER	Certificated	T02	05	P	A	1.00	43,822	1.00	42,509
EDN150/FA	8/6/2012	600005	SPEC ED TEACHER	Certificated	T02	05	T	A			1.00	42,509
EDN100/AA	8/6/2012	66106	12-MO SECONDARY TEACHER	Certificated	T02	05	P	A	1.00	53,420	1.00	42,509

<u>Prog ID/Org</u>	<u>New Hire Effective Date</u>	<u>Position Number</u>	<u>Position Title</u>	<u>Exempt (Y/N)</u>	<u>SR Level</u>	<u>BU Code</u>	<u>T/P</u>	<u>MOF</u>	<u>Budgeted FTE</u>	<u>Budgeted Salary</u>	<u>Actual FTE</u>	<u>Actual Salary</u>
EDN100/AA	8/6/2012	600057	ELEM TEACHER	Certificated	T02	05	T	A			1.00	42,509
EDN100/AA	8/6/2012	603593	ELEM TEACHER	Certificated	T03	05	T	A			1.00	45,909
EDN100/AA	8/6/2012	603594	ELEM TEACHER	Certificated	T03	05	T	A			1.00	45,909
EDN150/YC	8/6/2012	58399	BEHAVIORAL HLTH SPCLT III	N	SR20	13	T	A	1.00	42,066	1.00	21,881
EDN100/AA	8/6/2012	603583	ELEM TEACHER	Certificated	T03	05	T	A			1.00	45,909
EDN400/OC	8/6/2012	16797	UTILITY WORKER	N	BC03	01	P	A	1.00	30,682	1.00	17,744
EDN100/BM	8/6/2012	800258	ATHLETIC HLTH CARE TRAINER	Y	SR22	13	P	A	1.00	42,073	1.00	23,663
EDN100/AA	8/7/2012	603400	SECONDARY TEACHER	Certificated	T03	05	T	A			1.00	45,909
EDN150/FA	8/8/2012	55744	EDUC ASST I	Y	SR08	03	T	A	0.50	12,158	0.50	6,664
EDN100/AA	8/8/2012	55024	SCHOOL CUSTODIAN II	N	BC02	01	P	A	1.00	33,228	1.00	33,228
EDN150/FA	8/8/2012	73732	SPEC ED TEACHER	Certificated	T02	05	P	A	1.00	47,851	1.00	32,222
EDN100/AA	8/8/2012	69178	SECONDARY TEACHER	Certificated	T02	05	P	A	1.00	43,822	1.00	49,991
EDN150/NB	8/8/2012	600607	DIST OFF TCHR	Certificated	T02	05	T	N			1.00	42,509
EDN150/FA	8/8/2012	68196	SPEC ED TEACHER	Certificated	T02	05	P	A	1.00	44,671	1.00	32,222
EDN100/AA	8/8/2012	62693	COUNSELOR	Certificated	T02	05	P	A	1.00	58,959	1.00	42,509
EDN100/AA	8/8/2012	603389	SECONDARY TEACHER	Certificated	T02	05	T	A			1.00	32,222
EDN100/AA	8/8/2012	603589	ELEM TEACHER	Certificated	T03	05	T	A			1.00	45,909
EDN100/AA	8/9/2012	68846	COUNSELOR	Certificated	T03	05	P	A	1.00	51,426	1.00	45,909
EDN100/AA	8/9/2012	64611	SECONDARY TEACHER	Certificated	T02	05	P	A	1.00	43,048	1.00	32,222
EDN100/AA	8/10/2012	602309	SECONDARY TEACHER	Certificated	T02	05	T	A			1.00	37,893
EDN100/BM	8/10/2012	52462	ATHLETIC HLTH CARE TRAINER	Y	SR22	13	P	A	1.00	42,073	1.00	45,576
EDN100/AA	8/13/2012	62898	ELEM TEACHER	Certificated	T03	05	P	A	1.00	53,348	1.00	45,909
EDN150/FA	8/13/2012	72127	SPEC ED TEACHER	Certificated	T03	05	P	A	1.00	41,362	1.00	53,990
EDN150/FA	8/13/2012	65222	SPEC ED TEACHER	Certificated	T03	05	P	A	1.00	42,602	1.00	53,990
EDN100/AA	8/13/2012	603599	ELEM TEACHER	Certificated	T02	05	T	A			1.00	42,509
EDN100/AA	8/13/2012	802253	DP USER SUPPORT TECH II	N	SR15	03	T	A			1.00	17,528
EDN150/FA	8/13/2012	65453	GEN EDUC/ARTICLE VI TCHR	Certificated	T02	05	P	A	1.00	73,901	1.00	42,509
EDN100/AA	8/13/2012	601918	ELEM TEACHER	Certificated	T03	05	T	A			1.00	45,909
EDN100/AA	8/13/2012	29319	SCHOOL HEALTH AIDE	N	SR09	03	P	A	1.00	18,793	1.00	13,867
EDN150/FA	8/13/2012	600590	SPEC ED TEACHER	Certificated	T02	05	T	A			1.00	42,509
EDN150/YC	8/13/2012	802365	BEHAVIORAL HLTH SPCLT III	N	SR20	13	T	A			1.00	21,881
EDN150/FA	8/13/2012	55305	EDUC ASST I	Y	SR08	03	P	A	0.75	18,237	0.75	9,995
EDN100/AA	8/14/2012	603590	ELEM TEACHER	Certificated	T03	05	T	A			1.00	45,909
EDN400/OC	8/14/2012	34313	ENGINEER V	N	SR26	13	P	A	1.00	63,026	1.00	28,814
EDN150/SA	8/14/2012	30439	SPEECH PATHOLOGIST IV	Y	SR22	13	P	A	1.00	63,937	0.50	22,788
EDN150/FA	8/15/2012	72224	SPEC ED TEACHER	Certificated	T03	05	P	A	1.00	42,602	1.00	53,990
EDN100/AA	8/15/2012	603606	ELEM TEACHER	Certificated	T02	05	T	A			1.00	42,509
EDN150/FA	8/15/2012	603134	SPEC ED TEACHER	Certificated	T03	05	T	A			1.00	53,990
EDN150/FA	8/15/2012	71681	GEN EDUC/ARTICLE VI TCHR	Certificated	T02	05	P	A	1.00	48,469	1.00	32,222
EDN100/AA	8/15/2012	802735	EDUC ASST I	Y	SR08	03	T	A			1.00	13,327
EDN100/AA	8/15/2012	33150	SCHOOL SECURITY ATTENDANT	N	SR07	03	P	A	1.00	28,209	1.00	12,798
EDN100/AA	8/16/2012	802690	DP USER SUPPORT TECH II	N	SR15	03	T	A			1.00	17,528
EDN100/AA	8/16/2012	36296	OFFICE ASSISTANT III	N	SR08	03	P	A	1.00	28,836	1.00	13,327
EDN300/KD	8/16/2012	602519	DOE AUDITOR SPEC II	Certificated	E07	06	P	A			1.00	77,069
EDN150/FA	8/16/2012	60796	SPEC ED TEACHER	Certificated	T02	05	P	A	1.00	48,823	1.00	42,509
EDN100/AA	8/16/2012	56534	OFFICE ASSISTANT III	N	SR08	03	P	A	1.00	30,036	1.00	13,327
EDN100/AA	8/16/2012	55353	OFFICE ASSISTANT III	N	SR08	03	P	A	1.00	27,756	1.00	25,668

Department of Education
New Hires

Table 16

<u>Prog ID/Org</u>	<u>New Hire Effective Date</u>	<u>Position Number</u>	<u>Position Title</u>	<u>Exempt (Y/N)</u>	<u>SR Level</u>	<u>BU Code</u>	<u>T/P</u>	<u>MOF</u>	<u>Budgeted FTE</u>	<u>Budgeted Salary</u>	<u>Actual FTE</u>	<u>Actual Salary</u>
EDN400/OC	8/16/2012	802510	PROFESSIONAL TRAINEE I	N	SR16	13	P	A			1.00	36,024
EDN150/SA	8/20/2012	56234	OFFICE ASSISTANT III	N	SR08	03	T	A	0.50	13,308	0.50	6,664
EDN100/AA	8/20/2012	66232	ELEM TEACHER	Certificated	T03	05	T	A	1.00	43,822	1.00	53,990
EDN150/FA	8/20/2012	62427	GEN EDUC/ARTICLE VI TCHR	Certificated	T03	05	P	A	1.00	52,396	1.00	45,909
EDN100/AA	8/20/2012	802197	DP USER SUPPORT TECH II	N	SR15	03	T	A			1.00	17,528
EDN150/FA	8/20/2012	67115	SPEC ED TEACHER	Certificated	T02	05	P	A	1.00	41,362	1.00	32,222
EDN150/FA	8/20/2012	63974	SPEC ED TEACHER	Certificated	T02	05	P	A	1.00	46,011	1.00	32,222
EDN100/AA	8/20/2012	603588	ELEM TEACHER	Certificated	T03	05	T	A			1.00	45,909
EDN100/AA	8/20/2012	603603	ELEM TEACHER	Certificated	T02	05	T	A			1.00	42,509
EDN100/AA	8/20/2012	68773	SECONDARY TEACHER	Certificated	T03	05	P	A	1.00	31,679	1.00	34,799
EDN100/AA	8/20/2012	56588	OFFICE ASSISTANT III	N	SR08	03	P	A	0.50	12,834	0.50	6,664
EDN100/AA	8/20/2012	33168	SCHOOL SECURITY ATTENDANT	N	SR07	03	P	A	1.00	26,131	1.00	12,798
EDN100/AA	8/20/2012	802521	OFFICE ASSISTANT III	N	SR08	03	T	A			1.00	13,327
EDN100/AA	8/20/2012	603387	SECONDARY TEACHER	Certificated	T02	05	T	A			1.00	42,509
EDN400/OC	8/20/2012	17102	WELDER I	N	BC10	01	P	A	1.00	41,524	1.00	24,008
EDN100/AA	8/20/2012	603388	SECONDARY TEACHER	Certificated	T02	05	T	A			1.00	32,222
EDN150/FA	8/21/2012	30755	EDUC ASST II	Y	SR10	03	P	A	1.00	33,223	1.00	23,130
EDN100/AA	8/21/2012	603547	ELEM TEACHER	Certificated	T02	05	T	A			1.00	42,509
EDN100/AA	8/22/2012	603604	ELEM TEACHER	Certificated	T03	05	T	A			1.00	45,909
EDN100/AA	8/22/2012	69246	ELEM TEACHER	Certificated	T03	05	P	A	1.00	59,793	1.00	45,909
EDN100/AA	8/22/2012	603592	ELEM TEACHER	Certificated	T02	05	T	A			1.00	42,509
EDN500/WA	8/22/2012	59925	PROGRAM SPECIALIST IV	N	SR22	13	T	A			1.00	45,576
EDN400/OC	8/22/2012	34314	ENGINEER V	N	SR26	13	P	A	1.00	63,026	1.00	28,814
EDN100/AA	8/23/2012	29316	SCHOOL HEALTH AIDE	N	SR09	03	P	A	1.00	19,575	1.00	13,867
EDN100/AA	8/23/2012	603586	COUNSELOR	Certificated	T02	05	T	A			1.00	42,509
EDN100/AA	8/23/2012	603597	ELEM TEACHER	Certificated	T03	05	T	A			1.00	45,909
EDN150/FA	8/27/2012	57068	EDUC ASST III	Y	SR12	03	P	A	1.00	24,314	1.00	25,030
EDN400/MD	8/27/2012	10838	SCHOOL COOK II	N	BC06	01	P	B	1.00	12,012	1.00	19,958
EDN100/AA	8/27/2012	68193	ELEM TEACHER	Certificated	T02	05	P	A	1.00	55,434	1.00	42,509
EDN100/AA	8/27/2012	56654	OFFICE ASSISTANT III	N	SR08	03	P	A	1.00	35,064	1.00	13,327
EDN150/NB	8/27/2012	802339	BEHAVIORAL HLTH SPLCT III	N	SR20	13	T	N			1.00	21,881
EDN150/FA	8/27/2012	57924	EDUC ASST III	Y	SR12	03	T	A	0.75	18,237	0.75	18,773
EDN100/AA	8/27/2012	61152	ELEM TEACHER	Certificated	T02	05	P	A	1.00	55,083	1.00	42,509
EDN500/PC	8/27/2012	802682	OFFICE ASSISTANT III	N	SR08	03	T	A			1.00	13,327
EDN150/SA	8/27/2012	27262	SPEECH PATHOLOGIST II	Y	SR18	13	P	A	1.00	60,973	1.00	20,239
EDN100/AA	8/27/2012	602968	ELEM TEACHER	Certificated	T02	05	T	A			1.00	42,509
EDN150/FA	8/27/2012	802704	EDUC ASST I	Y	SR08	03	T	A			0.50	6,664
EDN100/AA	8/28/2012	602808	COUNSELOR	Certificated	T03	05	T	A			1.00	45,909
EDN100/DE	8/28/2012	58900	OFFICE ASSISTANT III	N	SR08	03	T	N			1.00	25,668
EDN150/SA	8/28/2012	56186	SPEECH PATHOLOGIST IV	Y	SR22	13	P	A	1.00	63,874	1.00	45,576
EDN100/AA	8/29/2012	67438	ELEM TEACHER	Certificated	T02	05	P	A	1.00	46,492	1.00	42,509
EDN100/AA	8/29/2012	60494	ELEM TEACHER	Certificated	T02	05	P	A	1.00	53,348	1.00	42,509
EDN100/AA	8/29/2012	75806	SECONDARY TEACHER	Certificated	T02	05	T	A	1.00	44,339	1.00	32,222
EDN100/AA	8/29/2012	71736	ELEM TEACHER	Certificated	T02	05	P	A	1.00	46,492	1.00	42,509
EDN500/PC	8/29/2012	802668	ACCOUNT CLERK II	N	SR08	03	T	A			1.00	13,327
EDN400/MD	8/30/2012	49641	CAFETERIA HELPER	N	BC02	01	T	B			0.50	16,614
EDN100/AA	8/30/2012	69928	ELEM TEACHER	Certificated	T03	05	P	A	1.00	44,265	1.00	45,909

Department of Education
New Hires

Table 16

<u>Prog ID/Org</u>	<u>New Hire Effective Date</u>	<u>Position Number</u>	<u>Position Title</u>	<u>Exempt (Y/N)</u>	<u>SR Level</u>	<u>BU Code</u>	<u>T/P</u>	<u>MOF</u>	<u>Budgeted FTE</u>	<u>Budgeted Salary</u>	<u>Actual FTE</u>	<u>Actual Salary</u>
EDN150/FA	8/30/2012	72758	SPEC ED TEACHER	Certificated	T02	05	P	A	1.00	51,755	1.00	32,222
EDN100/AA	8/30/2012	74282	SECONDARY TEACHER	Certificated	T02	05	T	A	1.00	46,492	1.00	32,222
EDN150/FA	8/31/2012	62074	SPEC ED TEACHER	Certificated	T02	05	P	A	1.00	49,765	1.00	32,222
EDN150/FA	9/4/2012	64930	SPEC ED TEACHER	Certificated	T02	05	P	A	1.00	30,439	1.00	32,222
EDN100/AA	9/4/2012	16708	SCHOOL CUSTODIAN II	N	BC02	01	P	A	0.75	24,921	0.75	12,944
EDN100/AA	9/4/2012	36596	SCHOOL HEALTH AIDE	N	SR09	03	P	A	1.00	18,793	1.00	13,867
EDN100/AA	9/4/2012	29793	SCHOOL HEALTH AIDE	N	SR09	03	P	A	1.00	22,852	1.00	13,867
EDN100/AA	9/4/2012	36271	ACCOUNT CLERK IV	N	SR13	03	P	A	1.00	41,040	1.00	31,212
EDN100/AA	9/4/2012	603538	SECONDARY TEACHER	Certificated	T02	05	T	A			0.50	16,111
EDN100/AA	9/4/2012	801739	SCHOOL CUSTODIAN II	N	BC02	01	P	A			0.50	16,614
EDN150/FA	9/4/2012	53011	EDUC ASST III	Y	SR12	03	P	A	0.63	15,197	0.63	15,644
EDN150/FA	9/4/2012	56933	EDUC ASST III	Y	SR12	03	P	A	1.00	28,385	1.00	25,030
EDN100/AA	9/4/2012	65151	ELEM TEACHER	Certificated	T02	05	P	A	1.00	46,492	1.00	42,509
EDN100/AA	9/4/2012	29379	SCHOOL HEALTH AIDE	N	SR09	03	P	A	1.00	18,089	1.00	13,867
EDN100/AA	9/4/2012	66942	ELEM TEACHER	Certificated	T02	05	P	A	1.00	58,295	1.00	42,509
EDN100/AA	9/4/2012	603609	ELEM TEACHER	Certificated	T02	05	T	A			1.00	42,509
EDN150/FA	9/4/2012	67385	SPEC ED TEACHER	Certificated	T02	05	P	A	1.00	47,851	1.00	32,222
EDN100/AA	9/4/2012	75334	COUNSELOR/HIGH RISK	Certificated	T02	05	T	A	1.00	53,483	1.00	49,991
EDN150/FA	9/4/2012	69324	GEN EDUC/ARTICLE VI TCHR	Certificated	T02	05	P	A	1.00	40,285	1.00	32,222
EDN150/FA	9/4/2012	801903	EDUC ASST I	Y	SR08	03	P	A			0.75	9,995
EDN100/AA	9/4/2012	802739	SCHOOL SECURITY ATTENDANT	N	SR07	03	T	A			1.00	12,798
EDN100/AA	9/4/2012	69390	SECONDARY TEACHER	Certificated	T02	05	P	A	1.00	43,822	1.00	42,509
EDN100/AA	9/4/2012	68471	SECONDARY TEACHER	Certificated	T02	05	P	A	1.00	61,567	1.00	32,222
EDN100/AA	9/4/2012	16634	SCHOOL CUSTODIAN III	N	WS02	01	P	A	1.00	35,544	1.00	35,544
EDN100/AA	9/4/2012	67562	SECONDARY TEACHER	Certificated	T02	05	T	A	1.00	43,048	1.00	42,509
EDN150/FA	9/4/2012	75647	SPEC ED TEACHER	Certificated	T02	05	T	A	1.00	47,851	1.00	49,991
EDN150/FA	9/4/2012	55130	EDUC ASST III	Y	SR12	03	P	A	0.75	19,686	0.75	18,773
EDN100/AA	9/4/2012	65053	LIBRARIAN	Certificated	T02	05	P	A	1.00	75,983	1.00	42,509
EDN100/AA	9/4/2012	36295	OFFICE ASSISTANT III	N	SR08	03	P	A	1.00	28,836	1.00	25,668
EDN100/AA	9/4/2012	62913	SECONDARY TEACHER	Certificated	T02	05	P	A	1.00	74,436	1.00	42,509
EDN150/SA	9/4/2012	56309	OCC THERAPIST IV	N	SR22	13	P	A	1.00	52,019	1.00	23,663
EDN500/PC	9/4/2012	58845	ACCOUNT CLERK II	N	SR08	03	T	A	1.00	27,394	0.50	6,664
EDN150/SA	9/4/2012	30935	COMMUNICATION AIDE	Y	SR12	03	P	A	1.00	26,024	1.00	15,595
EDN150/YG	9/4/2012	801875	EDUC ASST I	Y	SR08	03	T	A			1.00	13,327
EDN400/OC	9/5/2012	802440	AUXILIARY SERVICES ADMINISTRATOR	N	EM07	13	P	A			1.00	112,596
EDN150/FA	9/5/2012	52627	EDUC ASST I	Y	SR08	03	P	A	0.75	22,171	0.75	9,995
EDN100/AA	9/5/2012	68119	COUNSELOR	Certificated	T03	05	P	A	1.00	59,010	1.00	45,909
EDN150/FA	9/6/2012	65263	GEN EDUC/ARTICLE VI TCHR	Certificated	T02	05	P	A	1.00	42,738	1.00	42,509
EDN100/AA	9/6/2012	62308	ELEM TEACHER	Certificated	T03	05	P	A	1.00	58,810	1.00	45,909
EDN150/FA	9/7/2012	58139	EDUC ASST I	Y	SR08	03	P	A	0.75	19,686	0.75	9,995
EDN150/YG	9/7/2012	800792	EDUC ASST I	Y	SR08	03	P	A	1.00	28,145	1.00	13,327
EDN300/KO	9/10/2012	45344	OFFICE ASSISTANT IV	N	SR10	03	P	A	1.00	32,873	1.00	14,407
EDN100/AA	9/10/2012	603621	ELEM TEACHER	Certificated	T02	05	T	A			1.00	42,509
EDN100/AA	9/10/2012	603622	ELEM TEACHER	Certificated	T02	05	T	A			1.00	42,509
EDN150/FA	9/10/2012	802703	EDUC ASST I	Y	SR08	03	T	A			1.00	13,327
EDN100/AA	9/10/2012	603623	ELEM TEACHER	Certificated	T02	05	T	A			1.00	42,509
EDN400/OC	9/10/2012	802468	ACCOUNT CLERK IV	N	SR13	03	T	W			1.00	31,212

Department of Education
New Hires

Table 16

<u>Prog ID/Org</u>	<u>New Hire Effective Date</u>	<u>Position Number</u>	<u>Position Title</u>	<u>Exempt (Y/N)</u>	<u>SR Level</u>	<u>BU Code</u>	<u>T/P</u>	<u>MOF</u>	<u>Budgeted FTE</u>	<u>Budgeted Salary</u>	<u>Actual FTE</u>	<u>Actual Salary</u>
EDN150/YG	9/10/2012	603379	12-MO DIST OFF TCHR	Certificated	T02	05	P	A			1.00	32,222
EDN150/FA	9/10/2012	60077	SPEC ED TEACHER	Certificated	T03	05	P	A	1.00	44,671	1.00	53,990
EDN100/AA	9/10/2012	603620	ELEM TEACHER	Certificated	T02	05	T	A			1.00	42,509
EDN100/AA	9/10/2012	71257	ELEM TEACHER	Certificated	T03	05	P	A	1.00	45,138	1.00	53,990
EDN150/FA	9/10/2012	75266	SPEC ED TEACHER	Certificated	T03	05	P	A	1.00	49,765	1.00	45,909
EDN150/SA	9/10/2012	30449	SPEECH PATHOLOGIST II	Y	SR18	13	P	A	1.00	54,027	1.00	38,988
EDN100/AA	9/10/2012	802110	EDUC ASST III	Y	SR12	03	T	A			1.00	25,030
EDN150/YC	9/10/2012	59130	OFFICE ASSISTANT III	N	SR08	03	T	A	0.50	12,809	0.50	6,664
EDN100/AA	9/10/2012	62015	SECONDARY TEACHER	Certificated	T02	05	P	A	0.50	27,135	0.50	16,111
EDN100/AA	9/10/2012	603626	ELEM TEACHER	Certificated	T03	05	T	A			1.00	45,909
EDN100/BM	9/10/2012	52463	ATHLETIC HLTH CARE TRAINER	Y	SR22	13	P	A	1.00	42,073	1.00	45,576
EDN200/GJ	9/11/2012	57804	OFFICE ASSISTANT III	N	SR08	03	P	A	1.00	32,192	1.00	25,668
EDN100/AA	9/11/2012	603610	COUNSELOR	Certificated	T02	05	T	A			0.50	21,255
EDN100/AA	9/11/2012	603631	ELEM TEACHER	Certificated	T02	05	T	A			1.00	42,509
EDN150/FA	9/12/2012	76127	GEN EDUC/ARTICLE VI TCHR	Certificated	T02	05	P	A	1.00	43,507	1.00	42,509
EDN100/AA	9/12/2012	68910	ELEM TEACHER	Certificated	T02	05	T	A	1.00	40,577	1.00	42,509
EDN150/NB	9/13/2012	800459	SCHOOL PSYCHOLOGIST	Y	SR24	13	T	N	1.00	58,716	1.00	51,312
EDN100/AA	9/14/2012	67231	ELEM TEACHER	Certificated	T02	05	P	A	1.00	62,391	1.00	42,509
EDN150/FA	9/14/2012	801790	EDUC ASST III	Y	SR12	03	T	A			1.00	25,030
EDN150/YG	9/17/2012	802601	EDUC ASST I	Y	SR08	03	T	A			1.00	13,327
EDN100/AA	9/17/2012	802743	SCHOOL SECURITY ATTENDANT	N	SR07	03	T	A			0.50	6,399
EDN150/FA	9/17/2012	37501	EDUC ASST I	Y	SR08	03	P	A	1.00	25,266	1.00	13,327
EDN150/YG	9/17/2012	801879	EDUC ASST I	Y	SR08	03	T	A			1.00	13,327
EDN150/YG	9/17/2012	802382	EDUC ASST I	Y	SR08	03	T	A			1.00	13,327
EDN150/FA	9/17/2012	60381	SPEC ED TEACHER	Certificated	T02	05	P	A	1.00	48,813	1.00	32,222
EDN100/AA	9/17/2012	29495	SCHOOL HEALTH AIDE	N	SR09	03	P	A	1.00	22,852	1.00	13,867
EDN150/SA	9/17/2012	32738	OCC THERAPIST IV	N	SR22	03	P	A	1.00	55,495	1.00	23,663
EDN150/FA	9/17/2012	64177	SPEC ED TEACHER	Certificated	T02	05	P	A	1.00	40,157	1.00	32,222
EDN150/YG	9/17/2012	802602	EDUC ASST I	Y	SR08	03	T	A			1.00	13,327
EDN150/YC	9/17/2012	801436	BEHAVIORAL HLTH SPCLT III	N	SR20	13	P	A	0.50	21,880	0.50	10,940
EDN150/FA	9/17/2012	57317	EDUC ASST II	Y	SR10	03	T	A	1.00	26,248	1.00	23,130
EDN150/FA	9/17/2012	800571	EDUC ASST I	Y	SR08	03	T	A	0.75	18,237	0.75	9,995
EDN150/FA	9/17/2012	58138	EDUC ASST II	Y	SR10	03	P	A	0.75	19,686	0.75	17,348
EDN100/AA	9/17/2012	29315	SCHOOL HEALTH AIDE	N	SR09	03	P	A	1.00	17,401	1.00	13,867
EDN100/BM	9/17/2012	52457	ATHLETIC HLTH CARE TRAINER	Y	SR22	13	P	A	1.00	49,251	1.00	23,663
EDN100/AA	9/17/2012	68344	ELEM TEACHER	Certificated	T02	05	P	A	1.00	41,794	1.00	49,991
EDN100/AA	9/17/2012	73706	COUNSELOR	Certificated	T03	05	P	A	1.00	51,426	1.00	45,909
EDN150/FA	9/17/2012	74182	SPEC ED TEACHER	Certificated	T02	05	P	A	1.00	46,011	1.00	49,991
EDN100/AA	9/17/2012	68898	SECONDARY TEACHER	Certificated	T02	05	P	A	1.00	45,138	1.00	42,509
EDN150/FA	9/17/2012	60856	SPEC ED TCHR/PRE-SCHOOL	Certificated	T02	05	P	A	1.00	54,860	1.00	32,222
EDN150/YC	9/18/2012	58364	BEHAVIORAL HLTH SPCLT III	N	SR20	13	T	A	1.00	43,761	1.00	21,881
EDN100/AA	9/19/2012	603541	ELEM TEACHER	Certificated	T03	05	T	A			0.50	22,955
EDN150/FA	9/19/2012	601044	SPEC ED TCHR/PRE-SCHOOL	Certificated	T02	05	P	A			1.00	32,222
EDN150/NB	9/20/2012	802222	EDUC ASST III	Y	SR12	03	T	N			1.00	25,030
EDN150/FA	9/20/2012	57565	EDUC ASST II	Y	SR10	03	T	A	0.75	18,950	0.75	17,348
EDN100/AA	9/20/2012	75806	SECONDARY TEACHER	Certificated	T02	05	T	A	1.00	44,339	1.00	42,509
EDN150/YC	9/21/2012	58491	BEHAVIORAL HLTH SPCLT III	N	SR20	13	T	A	1.00	42,066	1.00	21,881

<u>Prog ID/Org</u>	<u>New Hire Effective Date</u>	<u>Position Number</u>	<u>Position Title</u>	<u>Exempt (Y/N)</u>	<u>SR Level</u>	<u>BU Code</u>	<u>T/P</u>	<u>MOF</u>	<u>Budgeted FTE</u>	<u>Budgeted Salary</u>	<u>Actual FTE</u>	<u>Actual Salary</u>
EDN150/NB	9/21/2012	58723	EDUC ASST III	Y	SR12	03	T	N			1.00	25,030
EDN300/KF	9/21/2012	66414	ACCTG OPERATION SPEC III	Certificated	E08	06	P	A	1.00	72,207	1.00	87,340
EDN150/FA	9/24/2012	73505	SPEC ED TEACHER	Certificated	T02	05	P	A	1.00	47,851	1.00	37,893
EDN100/AA	9/24/2012	802707	OFFICE ASSISTANT III	N	SR08	03	T	A			0.50	12,834
EDN100/AA	9/24/2012	802618	EDUC ASST III	Y	SR12	03	T	A			0.50	12,515
EDN150/YG	9/24/2012	802380	EDUC ASST I	Y	SR08	03	T	A			1.00	13,327
EDN150/YG	9/24/2012	802381	EDUC ASST I	Y	SR08	03	T	A			1.00	13,327
EDN100/AA	9/24/2012	603629	ELEM TEACHER	Certificated	T03	05	T	A			1.00	45,909
EDN100/AA	9/24/2012	602876	10-MONTH SAC TEACHER	Certificated	T03	05	T	A			1.00	53,990
EDN100/AA	9/24/2012	16657	SCHOOL CUSTODIAN II	N	BC02	01	P	A	1.00	33,228	1.00	33,228
EDN150/YG	9/24/2012	801835	EDUC ASST I	Y	SR08	03	T	A			1.00	13,327
EDN100/AA	9/24/2012	63479	ELEM TEACHER	Certificated	T03	05	P	A	1.00	74,436	1.00	45,909
EDN100/AA	9/24/2012	65549	SECONDARY TEACHER	Certificated	T02	05	P	A	1.00	74,436	1.00	32,222
EDN100/AA	9/24/2012	14739	OFFICE ASSISTANT III	N	SR08	03	P	A	1.00	28,836	1.00	25,668
EDN100/AA	9/24/2012	62601	ELEM TEACHER	Certificated	T02	05	P	A	1.00	52,279	1.00	42,509
EDN150/FA	9/24/2012	601028	GEN EDUC/ARTICLE VI TCHR	Certificated	T02	05	T	A			1.00	42,509
EDN150/FA	9/24/2012	63281	SPEC ED TEACHER	Certificated	T02	05	P	A	1.00	51,755	1.00	37,893
EDN100/AA	9/24/2012	603630	ELEM TEACHER	Certificated	T02	05	T	A			1.00	42,509
EDN100/AA	9/24/2012	71247	ELEM TEACHER	Certificated	T03	05	P	A	1.00	70,222	1.00	45,909
EDN100/AA	9/24/2012	65835	ELEM TEACHER	Certificated	T02	05	T	A	1.00	47,474	1.00	42,509
EDN150/FA	9/24/2012	57152	EDUC ASST III	Y	SR12	03	P	A			1.00	25,030
EDN150/YC	9/24/2012	802219	EDUC ASST I	Y	SR08	03	T	A			1.00	13,327
EDN150/FA	9/24/2012	64326	SPEC ED TEACHER	Certificated	T02	05	P	A	1.00	46,011	1.00	32,222
EDN150/NB	9/24/2012	802487	EDUC ASST III	Y	SR12	03	P	N			1.00	25,030
EDN150/YC	9/24/2012	800857	BEHAVIORAL HLTH SPCLT III	N	SR20	13	T	A	0.50	21,033	1.00	21,881
EDN150/YG	9/24/2012	801709	EDUC ASST III	Y	SR12	03	T	A			1.00	25,030
EDN100/AA	9/25/2012	69655	ELEM TEACHER	Certificated	T02	05	P	A	1.00	60,028	1.00	42,509
EDN150/FA	9/26/2012	58783	EDUC ASST II	Y	SR10	03	P	A	1.00	24,314	1.00	23,130
EDN150/FA	9/26/2012	48794	EDUC ASST III	Y	SR12	03	T	A	1.00	28,385	1.00	25,030
EDN100/AA	9/26/2012	603641	ELEM TEACHER	Certificated	T02	05	T	A			1.00	42,509
EDN150/FA	9/27/2012	601233	SPEC ED TCHR/PRE-SCHOOL	Certificated	T03	05	T	A			1.00	53,990
EDN150/FA	9/28/2012	603470	SPEC ED TEACHER	Certificated	T02	05	T	A			1.00	32,222
EDN150/FB	9/28/2012	60268	SPECIAL SCH TEACHER	Certificated	T02	05	P	A	1.00	44,268	1.00	37,893
EDN200/GJ	9/28/2012	76405	ACE INTERN	Certificated	E01	06	T	A	1.00	57,908	1.00	58,482
EDN150/FA	9/28/2012	74419	SPEC ED TEACHER	Certificated	T02	05	P	A	1.00	48,813	1.00	37,893
EDN150/FB	9/28/2012	61236	SPECIAL SCH TEACHER	Certificated	T03	05	P	A	1.00	46,559	1.00	53,990
EDN200/GJ	9/28/2012	76409	ACE INTERN	Certificated	E01	06	T	A	1.00	63,825	1.00	58,482
EDN100/AA	10/1/2012	29514	SCHOOL HEALTH AIDE	N	SR09	03	P	A	1.00	17,401	1.00	18,078
EDN100/AA	10/1/2012	56616	OFFICE ASSISTANT III	N	SR08	03	P	A	0.50	12,834	0.50	12,834
EDN150/FA	10/1/2012	52677	EDUC ASST II	Y	SR10	03	P	A	1.00	28,385	1.00	23,130
EDN100/AA	10/1/2012	55276	OFFICE ASSISTANT III	N	SR08	03	T	A	1.00	30,036	1.00	25,668
EDN100/AA	10/1/2012	53032	SCHOOL CUSTODIAN II	N	BC02	01	P	A	0.50	16,614	0.50	16,614
EDN150/SA	10/1/2012	56234	OFFICE ASSISTANT III	N	SR08	03	T	A	0.50	13,308	0.50	12,834
EDN150/YC	10/1/2012	58347	BEHAVIORAL HLTH SPCLT III	N	SR20	13	P	A	1.00	51,226	1.00	42,132
EDN100/AA	10/2/2012	802629	SCHOOL ADM SERVICES ASST I	N	SR12	04	P	A			1.00	15,595
EDN100/AA	10/2/2012	16307	SCHOOL CUSTODIAN II	N	BC02	01	P	A	0.50	16,614	0.50	8,629
EDN100/AA	10/2/2012	16310	SCHOOL CUSTODIAN II	N	BC02	01	P	A	0.50	16,614	0.50	8,629

Department of Education
New Hires

Table 16

<u>Prog ID/Org</u>	<u>New Hire Effective Date</u>	<u>Position Number</u>	<u>Position Title</u>	<u>Exempt (Y/N)</u>	<u>SR Level</u>	<u>BU Code</u>	<u>T/P</u>	<u>MOF</u>	<u>Budgeted FTE</u>	<u>Budgeted Salary</u>	<u>Actual FTE</u>	<u>Actual Salary</u>
EDN100/AA	10/2/2012	56566	OFFICE ASSISTANT III	N	SR08	03	P	A	0.50	12,834	0.50	12,834
EDN100/AA	10/3/2012	56599	OFFICE ASSISTANT III	N	SR08	03	P	A	0.50	12,834	0.50	12,834
EDN300/KO	10/8/2012	800131	EDUC ASST I	Y	SR08	03	T	A			1.00	13,327
EDN150/FA	10/8/2012	65518	GEN EDUC/ARTICLE VI TCHR	Certificated	T03	05	P	A	1.00	59,363	1.00	53,990
EDN150/YG	10/8/2012	802159	EDUC ASST III	Y	SR12	03	T	A			1.00	25,030
EDN100/AA	10/8/2012	602654	ELEM TEACHER	Certificated	T02	05	T	A			1.00	49,991
EDN150/YG	10/8/2012	802288	EDUC ASST II	Y	SR10	03	T	A			1.00	23,130
EDN100/AA	10/8/2012	603644	ELEM TEACHER	Certificated	T03	05	T	A			1.00	53,990
EDN100/AA	10/8/2012	603643	ELEM TEACHER	Certificated	T02	05	T	A			1.00	49,991
EDN100/AA	10/8/2012	603654	ELEM TEACHER	Certificated	T02	05	T	A			1.00	49,991
EDN150/YC	10/8/2012	58419	BEHAVIORAL HLTH SPCLT III	N	SR20	13	T	A	1.00	42,066	1.00	21,881
EDN150/FA	10/8/2012	57525	EDUC ASST I	Y	SR08	03	T	A	0.50	13,663	0.50	6,664
EDN100/AA	10/9/2012	73058	ELEM TEACHER	Certificated	T03	05	T	A	1.00	53,866	1.00	45,909
EDN150/FA	10/9/2012	800659	EDUC ASST III	Y	SR12	03	P	A			1.00	25,030
EDN150/FA	10/9/2012	57030	EDUC ASST III	Y	SR12	03	T	A			0.75	18,773
EDN100/AA	10/9/2012	62576	COUNSELOR	Certificated	T03	05	P	A	1.00	66,416	1.00	45,909
EDN100/AA	10/9/2012	802785	SCHOOL SECURITY ATTENDANT	N	SR07	03	T	A			1.00	12,798
EDN150/FA	10/9/2012	69582	SPEC ED TEACHER	Certificated	T02	05	P	A	1.00	65,506	1.00	32,222
EDN100/AA	10/9/2012	603550	SECONDARY TEACHER	Certificated	T02	05	T	A			1.00	42,509
EDN150/YG	10/9/2012	801871	EDUC ASST I	Y	SR08	03	T	A			1.00	13,327
EDN150/YG	10/9/2012	802600	EDUC ASST I	Y	SR08	03	T	A			1.00	13,327
EDN150/FA	10/9/2012	55322	EDUC ASST I	Y	SR08	03	P	A			1.00	13,327
EDN100/AA	10/9/2012	802780	EDUC ASST I	Y	SR08	03	T	A			1.00	13,327
EDN100/AA	10/9/2012	61218	ELEM TEACHER	Certificated	T02	05	P	A	1.00	45,138	1.00	42,509
EDN100/BB	10/9/2012	65595	SECONDARY TEACHER	Certificated	T02	05	P	A	1.00	55,932	1.00	32,222
EDN150/FA	10/9/2012	802702	EDUC ASST I	Y	SR08	03	P	A			0.75	9,995
EDN100/AA	10/9/2012	603653	SECONDARY TEACHER	Certificated	T03	05	T	A			0.50	18,459
EDN100/AA	10/9/2012	601291	10-MO STUDENT SVCS COORD	Certificated	T03	05	T	A			0.50	22,955
EDN100/AA	10/9/2012	603658	ELEM TEACHER	Certificated	T03	05	T	A			1.00	45,909
EDN150/FA	10/9/2012	74036	GEN EDUC/ARTICLE VI TCHR	Certificated	T02	05	P	A	1.00	45,341	1.00	32,222
EDN150/FA	10/9/2012	72250	SPEC ED TEACHER	Certificated	T02	05	P	A	1.00	41,362	1.00	42,509
EDN150/FA	10/9/2012	68542	SPEC ED TEACHER	Certificated	T02	05	T	A	1.00	42,602	1.00	32,222
EDN150/FA	10/9/2012	74869	SPEC ED TEACHER	Certificated	T03	05	P	A	1.00	46,011	1.00	45,909
EDN100/AA	10/9/2012	603656	ELEM TEACHER	Certificated	T02	05	T	A			1.00	42,509
EDN100/AA	10/9/2012	63690	ELEM TEACHER	Certificated	T02	05	P	A	1.00	46,492	1.00	42,509
EDN150/FA	10/9/2012	67382	SPEC ED TEACHER	Certificated	T03	05	P	A	1.00	73,666	1.00	45,909
EDN150/YC	10/9/2012	58315	BEHAVIORAL HLTH SPCLT III	N	SR20	13	P	A	1.00	45,533	1.00	21,881
EDN150/NB	10/9/2012	801755	EDUC ASST II	Y	SR10	03	T	N			0.75	17,348
EDN100/AA	10/9/2012	600095	SECONDARY TEACHER	Certificated	T02	05	T	A			1.00	42,509
EDN150/FA	10/9/2012	61026	SPEC ED TEACHER	Certificated	T02	05	T	A	1.00	43,369	1.00	42,509
EDN100/AA	10/9/2012	71549	ELEM TEACHER	Certificated	T02	05	P	A	1.00	64,264	1.00	42,509
EDN150/FA	10/9/2012	63822	SPEC ED TEACHER	Certificated	T02	05	P	A	1.00	47,851	1.00	32,222
EDN100/AA	10/9/2012	66059	ELEM TEACHER	Certificated	T02	05	P	A	1.00	45,138	1.00	42,509
EDN150/FA	10/9/2012	57483	EDUC ASST I	Y	SR08	03	P	A	0.50	14,193	0.50	6,664
EDN150/FA	10/9/2012	800600	EDUC ASST I	Y	SR08	03	T	A	0.50	12,158	0.50	6,664
EDN150/FA	10/9/2012	73916	SPEC ED TEACHER	Certificated	T03	05	P	A	1.00	46,011	1.00	45,909
EDN100/AA	10/9/2012	60821	SECONDARY TEACHER	Certificated	T02	05	T	A	1.00	41,794	1.00	32,222

<u>Prog ID/Org</u>	<u>New Hire Effective Date</u>	<u>Position Number</u>	<u>Position Title</u>	<u>Exempt (Y/N)</u>	<u>SR Level</u>	<u>BU Code</u>	<u>T/P</u>	<u>MOF</u>	<u>Budgeted FTE</u>	<u>Budgeted Salary</u>	<u>Actual FTE</u>	<u>Actual Salary</u>
EDN400/OD	10/10/2012	37392	SCHOOL CUSTODIAN II	N	BC02	01	P	A	0.50	14,922	0.50	8,629
EDN300/KF	10/10/2012	37315	PRE AUDIT CLERK II	N	SR13	03	P	A	1.00	30,335	1.00	16,211
EDN100/AA	10/12/2012	603628	SECONDARY TEACHER	Certificated	T03	05	T	A			1.00	45,909
EDN150/FA	10/12/2012	73672	SPEC ED TEACHER	Certificated	T03	05	T	A	1.00	51,258	1.00	45,909
EDN300/KO	10/12/2012	58579	PERSONNEL CLERK V	N	SR13	03	P	A	1.00	30,193	1.00	16,211
EDN100/AA	10/15/2012	72743	SECONDARY TEACHER	Certificated	T03	05	P	A	1.00	60,575	1.00	45,909
EDN150/FA	10/15/2012	73333	SPEC ED TEACHER	Certificated	T02	05	T	A	1.00	42,602	1.00	32,222
EDN150/FA	10/15/2012	65829	SPEC ED TEACHER	Certificated	T03	05	P	A	1.00	59,422	1.00	45,909
EDN100/AA	10/15/2012	802473	DP USER SUPPORT TECH II	N	SR15	03	T	A			1.00	17,528
EDN100/AA	10/15/2012	603646	ELEM TEACHER	Certificated	T02	05	T	A			1.00	42,509
EDN100/BB	10/15/2012	74206	SECONDARY TEACHER	Certificated	T02	05	P	A	1.00	40,941	1.00	32,222
EDN100/AA	10/15/2012	603660	ELEM TEACHER	Certificated	T03	05	T	A			1.00	45,909
EDN150/FA	10/15/2012	67941	SPEC ED TEACHER	Certificated	T02	05	P	A	1.00	43,369	1.00	42,509
EDN100/AA	10/15/2012	63461	ELEM TEACHER	Certificated	T02	05	P	A	1.00	53,866	1.00	42,509
EDN100/AA	10/16/2012	63479	ELEM TEACHER	Certificated	T03	05	P	A	1.00	74,436	1.00	45,909
EDN150/FA	10/16/2012	603472	SPEC ED TCHR/PRE-SCHOOL	Certificated	T02	05	T	A			1.00	32,222
EDN150/YG	10/16/2012	801863	EDUC ASST II	Y	SR10	03	T	A			1.00	23,130
EDN100/AA	10/16/2012	54848	OFFICE ASSISTANT III	N	SR08	03	T	A	0.50	13,350	0.50	12,834
EDN150/YC	10/16/2012	58410	BEHAVIORAL HLTH SPCLT III	N	SR20	13	P	A	1.00	42,066	1.00	42,132
EDN150/NB	10/16/2012	58188	EDUC ASST I	Y	SR08	03	T	N			1.00	21,390
EDN150/NB	10/16/2012	57376	EDUC ASST I	Y	SR08	03	T	N			1.00	13,327
EDN100/AA	10/17/2012	69431	ELEM TEACHER	Certificated	T02	05	P	A	1.00	57,098	1.00	42,509
EDN100/AA	10/17/2012	61498	ELEM TEACHER	Certificated	T03	05	P	A	1.00	40,577	1.00	45,909
EDN200/GN	10/18/2012	801957	OFFICE ASSISTANT III	N	SR08	03	T	A			0.50	12,834
EDN150/FA	10/18/2012	67024	SPEC ED TCHR/PRE-SCHOOL	Certificated	T02	05	P	A	1.00	56,010	1.00	42,509
EDN150/NB	10/19/2012	56843	EDUC ASST II	Y	SR10	03	T	N			1.00	23,130
EDN100/AA	10/19/2012	56549	OFFICE ASSISTANT III	N	SR08	03	P	A	0.50	12,834	0.50	12,834
EDN100/AA	10/22/2012	802812	EDUC ASST I	Y	SR08	03	T	A			1.00	13,327
EDN400/OC	10/22/2012	34314	ENGINEER III	N	SR22	13	P	A	1.00	63,026	1.00	45,576
EDN150/NB	10/22/2012	802469	CLINICAL PSYCHOLOGIST V	N	SR24	13	T	N			1.00	51,312
EDN150/NB	10/22/2012	58661	EDUC ASST III	Y	SR12	03	T	N			1.00	25,030
EDN100/AA	10/22/2012	16522	SCHOOL CUSTODIAN II	N	BC02	01	P	A	1.00	33,228	1.00	33,228
EDN150/YG	10/22/2012	802376	EDUC ASST I	Y	SR08	03	T	A			1.00	13,327
EDN150/SA	10/22/2012	32222	COMMUNICATION AIDE	Y	SR12	03	P	A	1.00	32,940	1.00	15,595
EDN150/NB	10/22/2012	600555	DIST OFF TCHR	Certificated	T03	05	T	N			1.00	53,990
EDN100/AA	10/22/2012	64967	SECONDARY TEACHER	Certificated	T03	05	P	A	1.00	70,222	1.00	53,990
EDN100/AA	10/22/2012	802728	EDUC ASST III	Y	SR12	03	T	A			1.00	25,030
EDN150/FA	10/22/2012	75613	GEN EDUC/ARTICLE VI TCHR	Certificated	T03	05	T	A	1.00	46,157	1.00	53,990
EDN100/AA	10/22/2012	55868	EDUC ASST I	Y	SR08	03	T	A	1.00	30,506	1.00	13,327
EDN100/AA	10/23/2012	603667	ELEM TEACHER	Certificated	T02	05	T	A			1.00	42,509
EDN150/FA	10/24/2012	63042	SPEC ED TEACHER	Certificated	T02	05	T	A	1.00	40,157	1.00	42,509
EDN150/FA	10/24/2012	55305	EDUC ASST I	Y	SR08	03	P	A	0.75	18,237	0.75	9,995
EDN150/FA	10/25/2012	75621	GEN EDUC/ARTICLE VI TCHR	Certificated	T02	05	T	A	1.00	56,011	1.00	49,991
EDN100/AA	10/25/2012	68236	SECONDARY TEACHER	Certificated	T02	05	P	A	1.00	30,757	1.00	42,509
EDN100/AA	10/26/2012	603651	ELEM TEACHER	Certificated	T02	05	T	A			1.00	42,509
EDN150/YG	10/26/2012	801817	SOCIAL WORKER IV	N	SR22	13	P	A			1.00	23,663
EDN100/AA	10/29/2012	29436	SCHOOL HEALTH AIDE	N	SR09	03	P	A	1.00	21,131	1.00	13,867

Department of Education
New Hires

Table 16

<u>Prog ID/Org</u>	<u>New Hire Effective Date</u>	<u>Position Number</u>	<u>Position Title</u>	<u>Exempt (Y/N)</u>	<u>SR Level</u>	<u>BU Code</u>	<u>T/P</u>	<u>MOF</u>	<u>Budgeted FTE</u>	<u>Budgeted Salary</u>	<u>Actual FTE</u>	<u>Actual Salary</u>
EDN150/NB	10/29/2012	38737	OFFICE ASSISTANT III	N	SR08	03	T	N			1.00	25,668
EDN150/NB	10/29/2012	57168	EDUC ASST II	Y	SR10	03	T	N			1.00	23,130
EDN300/KO	10/30/2012	800126	EDUC ASST I	Y	SR08	03	T	A			1.00	13,327
EDN100/AA	10/30/2012	600859	ELEM TEACHER	Certificated	T02	05	T	A			1.00	42,509
EDN150/NB	10/30/2012	802632	EDUC ASST III	Y	SR12	03	T	N			1.00	25,030
EDN150/YG	11/1/2012	802445	EDUC ASST II	Y	SR10	03	T	A			1.00	23,130
EDN150/FA	11/1/2012	57028	EDUC ASST III	Y	SR12	03	T	A	1.00	28,385	1.00	25,030
EDN150/FA	11/1/2012	49610	EDUC ASST II	Y	SR10	03	P	A	0.50	14,781	0.50	11,565
EDN100/AA	11/1/2012	30595	SCHOOL SECURITY ATTENDANT	N	SR07	03	P	A	1.00	21,444	1.00	20,540
EDN100/AA	11/1/2012	56004	OFFICE ASSISTANT III	N	SR08	03	P	A	1.00	28,836	1.00	25,668
EDN100/AA	11/1/2012	29331	SCHOOL HEALTH AIDE	N	SR09	03	P	A	1.00	21,131	1.00	13,867
EDN150/FA	11/1/2012	602976	SPEC ED TCHR/PRE-SCHOOL	Certificated	T02	05	T	A			1.00	42,509
EDN150/NB	11/1/2012	56129	SCHOOL PSYCHOLOGIST	Y	SR24	13	T	N			1.00	26,644
EDN300/KD	11/1/2012	603467	DOE COMM DIRECTOR	Certificated	E10	06	P	A			1.00	100,367
EDN100/AA	11/1/2012	600430	ELEM TEACHER	Certificated	T03	05	T	A			1.00	45,909
EDN150/NB	11/1/2012	802483	EDUC ASST I	Y	SR08	03	T	N			1.00	13,327
EDN100/AA	11/1/2012	55369	OFFICE ASSISTANT III	N	SR08	03	T	A	0.50	13,878	0.50	12,834
EDN150/SA	11/1/2012	801434	SPEECH PATHOLOGIST IV	Y	SR22	13	P	A	1.00	54,027	1.00	45,576
EDN400/OC	11/1/2012	17063	OFFICE ASSISTANT IV	N	SR10	03	P	A	1.00	25,897	1.00	27,756
EDN150/YG	11/1/2012	802597	BEHAVIORAL HLTH SPCLT III	N	SR20	13	T	A			1.00	42,132
EDN300/KD	11/1/2012	59880	AUDITOR V	N	SR24	13	P	A	1.00	53,963	1.00	55,500
EDN100/AA	11/1/2012	802131	OFFICE ASSISTANT III	N	SR08	03	T	A			0.50	12,834
EDN300/KD	11/1/2012	603473	DOE COMM SPEC II	Certificated	E07	06	P	A			1.00	77,069
EDN100/BM	11/1/2012	52471	ATHLETIC HLTH CARE TRAINER	Y	SR22	13	P	A	1.00	42,073	1.00	23,663
EDN150/FA	11/1/2012	55071	EDUC ASST II	Y	SR10	03	T	A	0.75	18,237	0.75	17,348
EDN100/AA	11/2/2012	67145	ELEM TEACHER	Certificated	T03	05	T	A	1.00	52,296	1.00	45,909
EDN150/FA	11/2/2012	36809	EDUC ASST II	Y	SR10	03	P	A	1.00	25,266	1.00	23,130
EDN100/AA	11/2/2012	65652	SECONDARY TEACHER	Certificated	T02	05	P	A	1.00	50,285	1.00	42,509
EDN100/AA	11/5/2012	44434	LIBRARY ASSISTANT IV	N	SR09	03	P	A	1.00	36,516	1.00	26,700
EDN150/NB	11/5/2012	801743	EDUC ASST I	Y	SR08	03	T	N			0.75	9,995
EDN150/FA	11/5/2012	65279	GEN EDUC/ARTICLE VI TCHR	Certificated	T02	05	P	A	1.00	42,738	1.00	42,509
EDN150/FA	11/5/2012	76154	SPEC ED TEACHER	Certificated	T03	05	P	A	1.00	40,157	1.00	45,909
EDN150/FA	11/5/2012	601076	GEN EDUC/ARTICLE VI TCHR	Certificated	T02	05	T	A			1.00	42,509
EDN100/BM	11/5/2012	800184	ATHLETIC HLTH CARE TRAINER	Y	SR22	13	P	A	1.00	45,540	1.00	23,663
EDN100/AA	11/5/2012	72712	ELEM TEACHER	Certificated	T03	05	P	A	1.00	57,098	1.00	45,909
EDN100/AA	11/7/2012	67729	SECONDARY TEACHER	Certificated	T03	05	P	A	1.00	53,052	1.00	45,909
EDN100/AA	11/8/2012	802684	SCHOOL SECURITY ATTENDANT	N	SR07	03	T	A			1.00	24,648
EDN150/FA	11/8/2012	58062	EDUC ASST I	Y	SR08	03	P	A	0.75	20,495	0.75	16,043
EDN150/NB	11/9/2012	801751	EDUC ASST II	Y	SR10	03	T	N			0.75	17,348
EDN150/FA	11/9/2012	67192	SPEC ED TEACHER	Certificated	T02	05	P	A	1.00	52,796	1.00	42,509
EDN100/AA	11/13/2012	802807	SCHOOL CUSTODIAN II	N	BC02	01	T	A			0.50	8,629
EDN400/MC	11/13/2012	801555	ACCOUNTANT II	N	SR18	13	T	N			1.00	38,988
EDN150/FA	11/13/2012	71630	SPEC ED TEACHER	Certificated	T03	05	P	A			1.00	53,990
EDN400/MC	11/13/2012	59553	ACCOUNTANT IV	N	SR22	13	T	N	1.00	45,576	1.00	45,576
EDN100/AA	11/13/2012	602687	SECONDARY TEACHER	Certificated	T02	05	T	A			1.00	42,509
EDN400/MD	11/15/2012	51647	CAFETERIA HELPER	N	BC02	01	T	B	0.50	5,192	0.50	8,629
EDN400/OC	11/16/2012	17208	BUILDING MAINTENANCE WORKER I	N	BC09	01	P	A	1.00	40,004	1.00	44,544

<u>Prog ID/Org</u>	<u>New Hire Effective Date</u>	<u>Position Number</u>	<u>Position Title</u>	<u>Exempt (Y/N)</u>	<u>SR Level</u>	<u>BU Code</u>	<u>T/P</u>	<u>MOF</u>	<u>Budgeted FTE</u>	<u>Budgeted Salary</u>	<u>Actual FTE</u>	<u>Actual Salary</u>
EDN100/AA	11/16/2012	56409	OFFICE ASSISTANT III	N	SR08	03	P	A	0.50	12,834	0.50	12,834
EDN400/MD	11/16/2012	802412	CAFETERIA HELPER	N	BC02	01	T	B			0.50	8,629
EDN300/KD	11/16/2012	603635	DOE AUDITOR SPEC II	Certificated	E07	06	P	A			1.00	77,069
EDN150/FA	11/16/2012	802799	EDUC ASST I	Y	SR08	03	T	A			0.50	6,664
EDN150/FA	11/16/2012	69456	SPEC ED TEACHER	Certificated	T02	05	P	A	1.00	49,765	1.00	49,991
EDN150/FA	11/16/2012	57603	EDUC ASST II	Y	SR10	03	P	A	0.75	18,237	0.75	17,348
EDN150/FA	11/16/2012	802620	EDUC ASST II	Y	SR10	03	P	A			0.75	17,348
EDN150/FA	11/16/2012	57399	EDUC ASST I	Y	SR08	03	T	A	0.75	21,289	0.75	9,995
EDN150/FA	11/16/2012	52681	EDUC ASST II	Y	SR10	03	P	A	0.50	12,158	0.50	11,565
EDN150/FA	11/16/2012	802562	EDUC ASST II	Y	SR10	03	P	A			1.00	23,130
EDN300/KF	11/16/2012	58240	PROCUREMENT AND CONTRACTS SUPPORT SPECIALIST IV	N	SR22	13	P	A	1.00	41,425	1.00	45,576
EDN100/AA	11/19/2012	55692	EDUC ASST I	Y	SR08	03	T	A	1.00	34,347	1.00	13,327
EDN150/FB	11/19/2012	802305	SCHOOL SECURITY ATTENDANT	N	SR07	03	T	A			1.00	20,540
EDN150/FA	11/19/2012	55201	EDUC ASST II	Y	SR10	03	P	A	1.00	27,326	1.00	23,130
EDN150/SA	11/19/2012	44050	OFFICE ASSISTANT III	N	SR08	03	P	A	1.00	26,570	1.00	25,668
EDN150/FA	11/19/2012	56066	EDUC ASST II	Y	SR10	03	P	A	1.00	27,326	1.00	23,130
EDN100/AA	11/20/2012	65207	SECONDARY TEACHER	Certificated	T02	05	P	A	1.00	44,339	1.00	37,893
EDN150/FA	11/21/2012	52552	EDUC ASST III	Y	SR12	03	P	A	1.00	28,385	1.00	25,030
EDN150/FA	11/21/2012	801462	EDUC ASST III	Y	SR12	03	T	A	1.00	24,314	1.00	25,030
EDN150/FA	11/26/2012	802858	EDUC ASST I	Y	SR08	03	P	A			1.00	13,327
EDN150/NB	11/26/2012	800176	EDUC ASST II	Y	SR10	03	T	N			1.00	23,130
EDN100/AA	11/26/2012	45078	SCHOOL CUSTODIAN II	N	BC02	01	P	A	0.50	16,614	0.50	16,614
EDN150/FA	11/26/2012	38914	EDUC ASST III	Y	SR12	03	P	A	1.00	33,223	1.00	25,030
EDN300/KD	11/26/2012	602581	INSTIT ANALYST III	Certificated	E08	06	P	A			1.00	91,060
EDN100/AA	11/26/2012	801067	OFFICE ASSISTANT II	N	SR06	03	T	A			0.50	11,844
EDN400/OC	11/26/2012	34313	ENGINEER III	N	SR22	13	P	A	1.00	63,026	1.00	23,663
EDN100/AA	11/27/2012	603634	SPEC ED TEACHER	Certificated	T02	05	T	A			1.00	42,509
EDN200/GB	11/27/2012	1784	PRIVATE SECRETARY I	N	SR20	03	P	A	1.00	36,802	1.00	21,308
EDN150/FA	11/27/2012	800085	EDUC ASST I	Y	SR08	03	T	A	1.00	26,248	1.00	13,327
EDN150/FA	11/28/2012	802349	EDUC ASST II	Y	SR10	03	T	A			1.00	23,130
EDN150/FA	11/28/2012	56746	EDUC ASST I	Y	SR08	03	P	A	1.00	26,248	0.75	9,995
EDN150/FA	11/28/2012	52569	EDUC ASST III	Y	SR12	03	P	A	1.00	30,736	1.00	25,030
EDN150/FA	11/29/2012	802798	EDUC ASST I	Y	SR08	03	T	A			0.50	6,664
EDN100/AA	11/29/2012	64245	ELEM TEACHER	Certificated	T02	05	P	A	1.00	43,048	1.00	42,509
EDN300/KO	11/29/2012	10407	PERSONNEL CLERK V	N	SR13	03	P	A	1.00	29,002	1.00	16,211
EDN150/SA	11/30/2012	50479	SOCIAL WORKER IV	N	SR22	13	P	A	1.00	52,649	1.00	45,576
EDN100/AA	11/30/2012	67044	ELEM TEACHER	Certificated	T03	05	P	A	1.00	74,436	1.00	45,909
EDN100/AA	12/3/2012	29517	SCHOOL HEALTH AIDE	N	SR09	03	P	A	1.00	17,401	1.00	13,867
EDN100/AA	12/3/2012	800941	OFFICE ASSISTANT II	N	SR06	03	T	A			0.50	11,844
EDN100/AA	12/3/2012	65298	SECONDARY TEACHER	Certificated	T03	05	P	A	1.00	55,482	1.00	45,909
EDN150/NB	12/3/2012	79997	DIST OFF TCHR	Certificated	T02	05	T	N			1.00	32,222
EDN150/FA	12/3/2012	56736	EDUC ASST I	Y	SR08	03	T	A	1.00	24,314	0.75	16,043
EDN150/FA	12/3/2012	28507	EDUC ASST II	Y	SR10	03	P	A	1.00	29,561	1.00	23,130
EDN100/AA	12/3/2012	29501	SCHOOL HEALTH AIDE	N	SR09	03	P	A	1.00	20,342	1.00	18,078
EDN400/MC	12/3/2012	36109	OFFICE ASSISTANT III	N	SR08	03	T	N	1.00	25,668	1.00	13,327
EDN150/FA	12/3/2012	602718	GEN EDUC/ARTICLE VI TCHR	Certificated	T02	05	T	A			1.00	42,509
EDN300/KO	12/3/2012	41968	PERSONNEL CLERK IV	N	SR11	03	P	A	1.00	36,708	1.00	14,969

<u>Prog ID/Org</u>	<u>New Hire Effective Date</u>	<u>Position Number</u>	<u>Position Title</u>	<u>Exempt (Y/N)</u>	<u>SR Level</u>	<u>BU Code</u>	<u>T/P</u>	<u>MOF</u>	<u>Budgeted FTE</u>	<u>Budgeted Salary</u>	<u>Actual FTE</u>	<u>Actual Salary</u>
EDN150/FA	12/3/2012	603684	SPEC ED TEACHER	Certificated	T02	05	T	A			1.00	42,509
EDN100/AA	12/3/2012	603679	ELEM TEACHER	Certificated	T03	05	T	A			1.00	45,909
EDN150/FA	12/3/2012	800045	EDUC ASST III	Y	SR12	03	P	A			0.75	18,773
EDN100/AA	12/3/2012	603688	ELEM TEACHER	Certificated	T03	05	T	A			1.00	45,909
EDN200/GN	12/3/2012	801957	OFFICE ASSISTANT III	N	SR08	03	T	A			0.50	6,664
EDN150/NB	12/4/2012	800361	EDUC ASST II	Y	SR10	03	T	N			1.00	23,130
EDN400/OC	12/5/2012	59831	SECRETARY II	N	SR14	03	P	A	1.00	28,281	1.00	32,424
EDN150/FA	12/10/2012	57345	EDUC ASST II	Y	SR10	03	P	A	0.75	18,237	0.75	17,348
EDN100/AA	12/10/2012	68034	COUNSELOR	Certificated	T03	05	P	A	1.00	48,008	1.00	45,909
EDN150/YG	12/10/2012	802381	EDUC ASST I	Y	SR08	03	T	A			1.00	13,327
EDN100/AA	12/10/2012	802418	DP USER SUPPORT TECH II	N	SR15	03	T	A			0.75	13,146
EDN150/YG	12/10/2012	802383	EDUC ASST I	Y	SR08	03	T	A			1.00	13,327
EDN100/AA	12/10/2012	75321	COUNSELOR	Certificated	T03	05	T	A	1.00	51,426	1.00	45,909
EDN100/AA	12/10/2012	67251	SECONDARY TEACHER	Certificated	T02	05	P	A	1.00	40,577	1.00	32,222
EDN150/FA	12/10/2012	56945	EDUC ASST II	Y	SR10	03	T	A	1.00	26,248	1.00	23,130
EDN100/AA	12/10/2012	603035	COUNSELOR	Certificated	T03	05	T	A			1.00	40,924
EDN150/FA	12/10/2012	63852	SPEC ED TCHR/PRE-SCHOOL	Certificated	T02	05	P	A	1.00	42,602	1.00	42,509
EDN100/BS	12/10/2012	73139	ROTC INSTRUCTOR	Certificated	ROTC	05	T	A	1.00	79,276	1.00	98,283
EDN400/OC	12/10/2012	55076	ENGINEER V	N	SR26	13	P	A	1.00	63,026	1.00	28,814
EDN150/FA	12/11/2012	68736	SPEC ED TEACHER	Certificated	T02	05	P	A			1.00	37,893
EDN100/AA	12/12/2012	63022	SECONDARY TEACHER	Certificated	T02	05	P	A	1.00	68,177	1.00	32,222
EDN150/FA	12/12/2012	75511	GEN EDUC/ARTICLE VI TCHR	Certificated	T02	05	T	A	1.00	46,157	1.00	42,509
EDN150/FA	12/13/2012	66614	SPEC ED TEACHER	Certificated	T02	05	P	A	1.00	40,157	1.00	32,222
EDN300/KF	12/17/2012	22467	ACCOUNTANT IV	N	SR22	13	P	A	1.00	47,945	1.00	23,663
EDN100/AA	12/18/2012	16461	SCHOOL CUSTODIAN II	N	BC02	01	P	A	0.50	16,614	0.50	16,614
EDN500/PC	12/24/2012	802681	OFFICE ASSISTANT III	N	SR08	03	T	A			1.00	13,327
EDN100/AA	12/26/2012	801166	SCHOOL CUSTODIAN II	N	BC02	01	T	A	0.50	16,614	0.50	16,614
EDN100/AA	1/2/2013	802806	LIBRARY ASSISTANT II	N	SR05	03	T	A			0.50	5,913
EDN400/MD	1/2/2013	802865	CAFETERIA HELPER	N	BC02	01	T	B			0.50	8,629
EDN100/AA	1/2/2013	16104	SCHOOL CUSTODIAN II	N	BC02	01	P	A	1.00	33,228	1.00	17,258
EDN100/AA	1/2/2013	56439	OFFICE ASSISTANT II	N	SR06	03	P	A	1.00	25,668	1.00	23,688
EDN150/YG	1/2/2013	800476	EDUC ASST II	Y	SR10	03	P	A	1.00	24,109	1.00	23,130
EDN150/YG	1/2/2013	801876	EDUC ASST I	Y	SR08	03	T	A			1.00	13,327
EDN150/NB	1/2/2013	802222	EDUC ASST I	Y	SR08	03	T	N			1.00	13,327
EDN400/OC	1/2/2013	800726	GEN PROF VI	N	SR26	13	P	A	1.00	58,831	1.00	82,128
EDN100/AA	1/2/2013	802572	ACCOUNT CLERK II	N	SR08	03	P	A			0.50	6,664
EDN100/AA	1/2/2013	802659	DP USER SUPPORT TECH II	N	SR15	03	T	A			1.00	17,528
EDN400/MD	1/3/2013	802403	CAFETERIA HELPER	N	BC02	01	T	B			0.50	16,614
EDN150/FA	1/3/2013	65050	GEN EDUC/ARTICLE VI TCHR	Certificated	T02	05	P	A	1.00	55,035	1.00	42,509
EDN400/MD	1/3/2013	380	SCHOOL FOOD SERVICES MGR II	N	F106	02	P	B			1.00	42,576
EDN100/AA	1/3/2013	62734	ELEM TEACHER	Certificated	T02	05	P	A	1.00	48,351	1.00	42,509
EDN100/AA	1/3/2013	55788	EDUC ASST I	Y	SR08	03	P	A	1.00	30,506	1.00	13,327
EDN400/MD	1/3/2013	26859	CAFETERIA HELPER	N	BC02	01	P	B	0.50	5,249	1.00	33,228
EDN100/AA	1/3/2013	60475	ELEM TEACHER	Certificated	T02	05	P	A	1.00	43,048	1.00	42,509
EDN400/MD	1/3/2013	9882	CAFETERIA HELPER	N	BC02	01	T	B			0.50	16,614
EDN100/AA	1/3/2013	63738	ELEM TEACHER	Certificated	T02	05	P	A	1.00	44,030	1.00	42,509
EDN150/FA	1/3/2013	65480	SPEC ED TEACHER	Certificated	T02	05	P	A	1.00	66,711	1.00	42,509

Department of Education
New Hires

Table 16

<u>Prog ID/Org</u>	<u>New Hire Effective Date</u>	<u>Position Number</u>	<u>Position Title</u>	<u>Exempt (Y/N)</u>	<u>SR Level</u>	<u>BU Code</u>	<u>T/P</u>	<u>MOF</u>	<u>Budgeted FTE</u>	<u>Budgeted Salary</u>	<u>Actual FTE</u>	<u>Actual Salary</u>
EDN100/AA	1/3/2013	600526	SECONDARY TEACHER	Certificated	T03	05	T	A			1.00	45,909
EDN150/FA	1/3/2013	32157	EDUC ASST I	Y	SR08	03	P	A	1.00	31,959	1.00	13,327
EDN150/FA	1/3/2013	63086	SPEC ED TEACHER	Certificated	T03	05	P	A	1.00	37,747	1.00	45,909
EDN150/FA	1/3/2013	62858	GEN EDUC/ARTICLE VI TCHR	Certificated	T03	05	P	A	1.00	44,813	1.00	45,909
EDN100/BJ	1/3/2013	69479	SECONDARY TEACHER	Certificated	T02	05	T	A			1.00	42,509
EDN150/FA	1/3/2013	62149	SPEC ED TEACHER	Certificated	T02	05	P	A	1.00	57,712	1.00	42,509
EDN100/AA	1/3/2013	603705	ELEM TEACHER	Certificated	T03	05	T	A			1.00	45,909
EDN100/AA	1/3/2013	71198	ELEM TEACHER	Certificated	T02	05	P	A	1.00	68,936	1.00	42,509
EDN100/AA	1/3/2013	60501	ELEM TEACHER	Certificated	T02	05	P	A	0.50	31,275	0.50	21,255
EDN100/AA	1/3/2013	68623	SECONDARY TEACHER	Certificated	T03	05	P	A	1.00	58,295	1.00	53,990
EDN100/AA	1/3/2013	66215	SECONDARY TEACHER	Certificated	T02	05	P	A	1.00	46,652	1.00	42,509
EDN100/AA	1/3/2013	63350	ELEM TEACHER	Certificated	T02	05	P	A	1.00	74,436	1.00	42,509
EDN150/FA	1/3/2013	601255	SPEC ED TEACHER	Certificated	T03	05	T	A			1.00	45,909
EDN100/AA	1/3/2013	60319	SECONDARY TEACHER	Certificated	T02	05	P	A	1.00	43,048	1.00	42,509
EDN100/AA	1/3/2013	57660	SCHOOL SECURITY ATTENDANT	N	SR07	03	P	A	1.00	21,444	1.00	20,540
EDN100/AA	1/3/2013	74666	ELEM TEACHER	Certificated	T02	05	T	A	1.00	47,398	1.00	42,509
EDN100/AA	1/3/2013	61856	LIBRARIAN	Certificated	T02	05	P	A	1.00	44,452	1.00	32,222
EDN100/AA	1/3/2013	603704	ELEM TEACHER	Certificated	T02	05	T	A			1.00	42,509
EDN150/FA	1/3/2013	61726	SPEC ED TCHR/PRE-SCHOOL	Certificated	T03	05	P	A	1.00	51,755	1.00	45,909
EDN100/AA	1/3/2013	69949	SECONDARY TEACHER	Certificated	T02	05	T	A	1.00	64,264	1.00	42,509
EDN100/AA	1/3/2013	67912	ELEM TEACHER	Certificated	T02	05	P	A	1.00	65,482	1.00	42,509
EDN100/AA	1/3/2013	60503	ELEM TEACHER	Certificated	T02	05	T	A	0.50	23,246	1.00	42,509
EDN100/DB	1/3/2013	603692	ELEM TEACHER	Certificated	T02	05	T	N			1.00	49,991
EDN150/FA	1/3/2013	603637	SPEC ED TEACHER	Certificated	T02	05	T	A			1.00	32,222
EDN100/AA	1/3/2013	71114	ELEM TEACHER	Certificated	T03	05	P	A	1.00	51,503	1.00	45,909
EDN150/FA	1/3/2013	71263	SPEC ED TEACHER	Certificated	T02	05	P	A	1.00	43,369	1.00	42,509
EDN100/AA	1/3/2013	62257	ELEM TEACHER	Certificated	T02	05	P	A	1.00	66,191	1.00	42,509
EDN100/AA	1/3/2013	603663	ELEM TEACHER	Certificated	T02	05	T	A			1.00	42,509
EDN100/AA	1/3/2013	72835	SECONDARY TEACHER	Certificated	T03	05	P	A	1.00	43,048	1.00	34,799
EDN150/FA	1/3/2013	601779	SPEC ED TEACHER	Certificated	T02	05	T	A			1.00	42,509
EDN150/FA	1/3/2013	601031	SPEC ED TEACHER	Certificated	T03	05	T	A			1.00	34,799
EDN100/AA	1/3/2013	66856	ELEM TEACHER	Certificated	T02	05	P	A	1.00	57,098	1.00	42,509
EDN150/FA	1/3/2013	64047	SPEC ED TEACHER	Certificated	T02	05	P	A	1.00	54,908	1.00	42,509
EDN100/AA	1/3/2013	61256	ELEM TEACHER	Certificated	T02	05	P	A	1.00	62,391	1.00	42,509
EDN100/AA	1/3/2013	74838	SECONDARY TEACHER	Certificated	T02	05	T	A	1.00	62,391	1.00	42,509
EDN150/FA	1/3/2013	603558	GEN EDUC/ARTICLE VI TCHR	Certificated	T03	05	T	A			1.00	45,909
EDN100/AA	1/3/2013	65962	ELEM TEACHER	Certificated	T02	05	P	A	1.00	46,492	1.00	42,509
EDN100/AA	1/3/2013	71062	ELEM TEACHER	Certificated	T03	05	P	A	1.00	66,191	1.00	45,909
EDN100/AA	1/3/2013	603690	ELEM TEACHER	Certificated	T03	05	T	A			1.00	45,909
EDN100/AA	1/3/2013	71582	ELEM TEACHER	Certificated	T03	05	P	A	1.00	52,296	1.00	45,909
EDN100/AA	1/3/2013	63845	ELEM TEACHER	Certificated	T03	05	P	A	1.00	65,247	1.00	45,909
EDN150/FA	1/3/2013	603536	SPEC ED TEACHER	Certificated	T02	05	T	A			1.00	42,509
EDN100/AA	1/3/2013	67661	ELEM TEACHER	Certificated	T02	05	P	A	1.00	57,098	1.00	42,509
EDN150/FA	1/3/2013	72473	SPEC ED TEACHER	Certificated	T02	05	P	A	1.00	47,851	1.00	32,222
EDN100/AA	1/3/2013	68450	SECONDARY TEACHER	Certificated	T02	05	P	A	1.00	45,138	1.00	42,509
EDN100/AA	1/3/2013	57923	SCHOOL CUSTODIAN II	N	BC02	01	P	A	0.50	16,614	0.50	16,614
EDN150/FA	1/3/2013	69602	SPEC ED TEACHER	Certificated	T02	05	P	A	1.00	49,765	0.50	16,111

Department of Education
New Hires

Table 16

<u>Prog ID/Org</u>	<u>New Hire Effective Date</u>	<u>Position Number</u>	<u>Position Title</u>	<u>Exempt (Y/N)</u>	<u>SR Level</u>	<u>BU Code</u>	<u>T/P</u>	<u>MOF</u>	<u>Budgeted FTE</u>	<u>Budgeted Salary</u>	<u>Actual FTE</u>	<u>Actual Salary</u>
EDN100/AA	1/3/2013	600447	COUNSELOR	Certificated	T03	05	T	A			1.00	45,909
EDN100/AA	1/3/2013	63641	ELEM TEACHER	Certificated	T03	05	P	A	1.00	58,860	1.00	45,909
EDN100/DB	1/3/2013	603689	DIST OFF TCHR	Certificated	T03	05	T	N			1.00	45,909
EDN150/FA	1/3/2013	65671	GEN EDUC/ARTICLE VI TCHR	Certificated	T03	05	P	A	1.00	44,813	1.00	45,909
EDN100/AA	1/3/2013	61942	SECONDARY TEACHER	Certificated	T02	05	P	A	1.00	64,264	1.00	42,509
EDN100/AA	1/3/2013	603696	ELEM TEACHER	Certificated	T02	05	T	A			1.00	42,509
EDN100/AA	1/3/2013	603708	ELEM TEACHER	Certificated	T02	05	T	A			1.00	49,991
EDN100/AA	1/3/2013	64551	SECONDARY TEACHER	Certificated	T02	05	P	A	1.00	45,138	1.00	49,991
EDN100/AA	1/3/2013	603707	ELEM TEACHER	Certificated	T02	05	T	A			0.50	21,255
EDN100/AA	1/3/2013	63034	SECONDARY TEACHER	Certificated	T02	05	P	A	1.00	51,296	1.00	42,509
EDN150/FA	1/3/2013	74905	SPEC ED TEACHER	Certificated	T03	05	P	A	1.00	54,513	1.00	45,909
EDN100/AA	1/3/2013	61729	SECONDARY TEACHER	Certificated	T02	05	P	A	1.00	47,039	1.00	42,509
EDN100/AA	1/3/2013	66491	SECONDARY TEACHER	Certificated	T02	05	P	A	1.00	55,434	1.00	42,509
EDN150/FA	1/3/2013	63487	SPEC ED TEACHER	Certificated	T02	05	P	A	1.00	51,755	1.00	42,509
EDN150/FA	1/3/2013	603627	SPEC ED TEACHER	Certificated	T02	05	T	A			1.00	42,509
EDN150/FA	1/3/2013	72572	SPEC ED TEACHER	Certificated	T02	05	P	A	1.00	48,813	1.00	42,509
EDN150/FA	1/3/2013	600157	SPEC ED TEACHER	Certificated	T02	05	T	A			1.00	42,509
EDN150/FA	1/3/2013	74426	SPEC ED TEACHER	Certificated	T02	05	P	A	1.00	41,362	1.00	42,509
EDN150/FA	1/3/2013	802703	EDUC ASST I	Y	SR08	03	T	A			1.00	13,327
EDN100/AA	1/3/2013	802477	DP USER SUPPORT TECH II	N	SR15	03	T	A			1.00	17,528
EDN200/GN	1/3/2013	33118	ACCOUNT CLERK III	N	SR11	03	P	A	0.50	14,176	0.50	7,484
EDN400/OD	1/4/2013	16394	SCHOOL CUSTODIAN II	N	BC02	01	P	A	1.00	35,544	1.00	17,258
EDN100/AA	1/4/2013	63119	ELEM TEACHER	Certificated	T02	05	P	A	1.00	57,145	1.00	42,509
EDN150/FA	1/4/2013	55659	EDUC ASST I	Y	SR08	03	P	A	0.50	12,158	0.50	6,664
EDN100/AA	1/7/2013	71033	ELEM TEACHER	Certificated	T02	05	P	A	1.00	64,264	1.00	42,509
EDN150/FA	1/7/2013	601617	SPEC ED TEACHER	Certificated	T03	05	T	A			1.00	45,909
EDN100/AA	1/7/2013	600924	COUNSELOR	Certificated	T03	05	T	A			1.00	45,909
EDN150/FA	1/7/2013	60700	GEN EDUC/ARTICLE VI TCHR	Certificated	T03	05	P	A	1.00	64,778	1.00	45,909
EDN150/FA	1/7/2013	802861	EDUC ASST I	Y	SR08	03	P	A			0.75	9,995
EDN100/AA	1/7/2013	69466	ELEM TEACHER	Certificated	T02	05	P	A	1.00	45,670	1.00	42,509
EDN100/AA	1/7/2013	801473	SCHOOL CUSTODIAN II	N	BC02	01	T	A			0.50	16,614
EDN150/FA	1/7/2013	602934	SPEC ED TEACHER	Certificated	T03	05	T	A			1.00	45,909
EDN100/AA	1/7/2013	67191	SECONDARY TEACHER	Certificated	T03	05	P	A	1.00	43,822	1.00	45,909
EDN400/OC	1/7/2013	17085	CARPENTER I	N	BC09	01	P	A	1.00	43,194	1.00	44,544
EDN150/FA	1/7/2013	67845	GEN EDUC/ARTICLE VI TCHR	Certificated	T02	05	P	A	1.00	55,035	1.00	42,509
EDN100/AA	1/7/2013	63266	ELEM TEACHER	Certificated	T02	05	P	A	1.00	61,845	1.00	42,509
EDN100/AA	1/7/2013	601747	ELEM TEACHER	Certificated	T02	05	T	A			1.00	42,509
EDN150/FA	1/8/2013	55069	EDUC ASST II	Y	SR10	03	P	A	1.00	28,385	1.00	23,130
EDN400/OC	1/8/2013	59887	ENERGY CONSERVATION COORD	N	SR24	13	P	A	1.00	36,756	1.00	26,644
EDN150/YC	1/9/2013	58746	BEHAVIORAL HLTH SPCLT III	N	SR20	13	P	A	1.00	42,066	1.00	21,881
EDN150/FA	1/9/2013	58068	EDUC ASST II	Y	SR10	03	T	A	0.75	20,495	0.75	17,348
EDN150/FA	1/10/2013	603320	GEN EDUC/ARTICLE VI TCHR	Certificated	T02	05	T	A			1.00	42,509
EDN150/FA	1/11/2013	26533	EDUC ASST II	Y	SR10	03	P	A	1.00	24,314	1.00	23,130
EDN100/AA	1/11/2013	602816	SECONDARY TEACHER	Certificated	T02	05	T	A			1.00	42,509
EDN100/AA	1/11/2013	62407	LIBRARIAN	Certificated	T03	05	P	A	1.00	56,917	1.00	45,909
EDN100/AA	1/11/2013	64362	COUNSELOR	Certificated	T03	05	P	A	1.00	48,008	1.00	45,909
EDN100/AA	1/14/2013	74312	SECONDARY TEACHER	Certificated	T03	05	P	A	1.00	59,617	1.00	45,909

<u>Prog ID/Org</u>	<u>New Hire Effective Date</u>	<u>Position Number</u>	<u>Position Title</u>	<u>Exempt (Y/N)</u>	<u>SR Level</u>	<u>BU Code</u>	<u>T/P</u>	<u>MOF</u>	<u>Budgeted FTE</u>	<u>Budgeted Salary</u>	<u>Actual FTE</u>	<u>Actual Salary</u>
EDN150/FA	1/14/2013	61906	SPEC ED TEACHER	Certificated	T02	05	P	A	1.00	49,286	1.00	42,509
EDN150/FA	1/14/2013	66715	SPEC ED TEACHER	Certificated	T02	05	P	A	1.00	65,506	1.00	32,222
EDN100/AA	1/14/2013	66679	ELEM TEACHER	Certificated	T02	05	P	A	1.00	51,400	1.00	49,991
EDN100/AA	1/14/2013	802683	SCHOOL SECURITY ATTENDANT	N	SR07	03	T	A			1.00	12,798
EDN150/FA	1/14/2013	67941	SPEC ED TEACHER	Certificated	T03	05	P	A	1.00	43,369	1.00	45,909
EDN300/KO	1/14/2013	14738	PERSONNEL CLERK V	N	SR13	03	P	A	1.00	27,918	1.00	16,211
EDN150/FA	1/15/2013	64481	SPEC ED TEACHER	Certificated	T02	05	P	A	1.00	42,567	1.00	49,991
EDN100/AA	1/16/2013	800669	GEN PROF IV	N	SR22	13	T	A	1.00	45,576	1.00	23,663
EDN150/FA	1/16/2013	57264	EDUC ASST II	Y	SR10	03	T	A	0.75	18,237	0.75	17,348
EDN150/SA	1/16/2013	801319	EDUCATIONAL INTERPRETER I	N	SR12	03	P	A	1.00	26,733	1.00	30,036
EDN100/AA	1/16/2013	67814	SECONDARY TEACHER	Certificated	T02	05	P	A	1.00	46,120	1.00	42,509
EDN100/AA	1/16/2013	65796	SECONDARY TEACHER	Certificated	T03	05	P	A	1.00	51,019	1.00	36,918
EDN100/AA	1/16/2013	63146	ELEM TEACHER	Certificated	T02	05	P	A	1.00	64,264	1.00	42,509
EDN300/KO	1/16/2013	58576	PERSONNEL CLERK V	N	SR13	03	P	A	1.00	33,961	1.00	16,211
EDN150/FA	1/17/2013	52706	EDUC ASST I	Y	SR08	03	T	A			1.00	21,390
EDN100/AA	1/17/2013	16552	SCHOOL CUSTODIAN II	N	BC02	01	P	A	0.50	16,614	0.50	16,614
EDN100/AA	1/18/2013	61647	SECONDARY TEACHER	Certificated	T02	05	P	A	1.00	43,048	1.00	42,509
EDN150/SA	1/18/2013	28718	OCC THERAPIST IV	N	SR22	13	P	A	1.00	56,680	1.00	23,663
EDN100/AA	1/22/2013	603695	SPEC ED TEACHER	Certificated	T02	05	T	A			1.00	32,222
EDN100/AA	1/22/2013	66665	ELEM TEACHER	Certificated	T02	05	T	A	1.00	63,374	1.00	42,509
EDN100/AA	1/22/2013	60206	ELEM TEACHER	Certificated	T02	05	P	A	1.00	44,265	1.00	42,509
EDN300/KD	1/22/2013	603243	DOE COMM SPEC II	Certificated	E07	06	P	A			1.00	77,069
EDN100/AA	1/23/2013	64778	SECONDARY TEACHER	Certificated	T02	05	P	A	1.00	47,398	1.00	42,509
EDN150/FA	1/23/2013	603518	SPEC ED TEACHER	Certificated	T02	05	T	A			1.00	42,509
EDN150/YC	1/23/2013	58084	HUMAN SVCS PROF IV	N	SR22	13	P	A	1.00	42,066	1.00	23,663
EDN150/FA	1/25/2013	802715	EDUC ASST I	Y	SR08	03	T	A			0.50	6,664
EDN100/AA	1/28/2013	61362	ELEM TEACHER	Certificated	T03	05	P	A	1.00	58,959	1.00	45,909
EDN100/AA	1/28/2013	603770	COUNSELOR	Certificated	T03	05	T	A			1.00	45,909
EDN150/FA	1/28/2013	57325	EDUC ASST I	Y	SR08	03	P	A	0.75	18,237	0.75	16,043
EDN100/AA	1/28/2013	603718	ELEM TEACHER	Certificated	T02	05	T	A			1.00	42,509
EDN400/MD	1/28/2013	50304	CAFETERIA HELPER	N	BC02	01	T	B			0.50	16,614
EDN300/UA	1/30/2013	42580	AUTOMATED SYSTS EQUIP TECH I	N	BC14	01	P	A	1.00	47,704	1.00	27,799
EDN300/KF	2/1/2013	802738	OFFICE ASSISTANT IV	N	SR10	03	T	A			1.00	27,756
EDN400/MD	2/1/2013	802847	CAFETERIA HELPER	N	BC02	01	T	B			0.50	16,614
EDN100/AA	2/1/2013	600503	SECONDARY TEACHER	Certificated	T03	05	T	A			1.00	45,909
EDN100/AA	2/1/2013	33123	SCHOOL SECURITY ATTENDANT	N	SR07	03	P	A	1.00	21,444	1.00	20,540
EDN400/MD	2/1/2013	50845	CAFETERIA HELPER	N	BC02	01	T	B			0.50	16,614
EDN100/AA	2/1/2013	57664	SCHOOL SECURITY ATTENDANT	N	SR07	03	P	A	1.00	21,444	1.00	20,540
EDN150/FA	2/1/2013	61242	SPEC ED TEACHER	Certificated	T02	05	P	A	1.00	54,860	1.00	42,509
EDN300/KO	2/1/2013	800126	EDUC ASST I	Y	SR08	03	T	A			1.00	13,327
EDN100/AA	2/1/2013	74101	10-MO STUDENT SVCS COORD	Certificated	T02	05	P	A	1.00	46,011	0.50	16,111
EDN100/AA	2/1/2013	40155	SCHOOL CUSTODIAN II	N	BC02	01	P	A	0.50	16,614	0.50	16,614
EDN150/FA	2/1/2013	62287	SPEC ED TEACHER	Certificated	T02	05	P	A	1.00	49,056	1.00	42,509
EDN150/FA	2/1/2013	66399	SPEC ED TEACHER	Certificated	T02	05	P	A	1.00	40,157	1.00	42,509
EDN150/FA	2/1/2013	71013	SPEC ED TEACHER	Certificated	T02	05	P	A	1.00	41,362	1.00	42,509
EDN100/AA	2/1/2013	61387	ELEM TEACHER	Certificated	T03	05	P	A	1.00	64,264	1.00	45,909
EDN100/AA	2/1/2013	56456	OFFICE ASSISTANT III	N	SR08	03	P	A	0.50	12,834	0.50	12,834

Prog ID/Org	New Hire Effective Date	Position Number	Position Title	Exempt (Y/N)	SR Level	BU Code	T/P	MOF	Budgeted FTE	Budgeted Salary	Actual FTE	Actual Salary
EDN150/YC	2/1/2013	59130	OFFICE ASSISTANT III	N	SR08	03	T	A	0.50	12,809	0.50	6,664
EDN100/AA	2/4/2013	56654	OFFICE ASSISTANT II	N	SR06	03	P	A	1.00	35,064	1.00	23,688
EDN100/AA	2/4/2013	53017	SCHOOL CUSTODIAN II	N	BC02	01	P	A	0.50	16,614	0.50	16,614
EDN100/CB	2/4/2013	800666	OFFICE ASSISTANT III	N	SR08	03	T	A	1.00	24,617	1.00	13,327
EDN150/SA	2/4/2013	46770	OFFICE ASSISTANT III	N	SR08	03	P	A	1.00	23,651	1.00	13,327
EDN100/AA	2/5/2013	19061	OFFICE ASSISTANT III	N	SR08	03	P	A	1.00	33,756	1.00	13,327
EDN500/PC	2/6/2013	802662	OFFICE ASSISTANT III	N	SR08	03	P	A			0.50	12,834
EDN150/FA	2/6/2013	602554	SPEC ED TCHR/PRE-SCHOOL	Certificated	T02	05	T	A			1.00	32,222
EDN100/AA	2/6/2013	603768	ELEM TEACHER	Certificated	T02	05	T	A			0.50	16,111
EDN150/FA	2/6/2013	602342	SPEC ED TEACHER	Certificated	T02	05	T	A			1.00	32,222
EDN150/YC	2/8/2013	58347	BEHAVIORAL HLTH SPCLT III	N	SR20	13	P	A	1.00	51,226	1.00	42,132
EDN400/MD	2/11/2013	55510	CAFETERIA HELPER	N	BC02	01	T	B	0.50	5,192	0.50	16,614
EDN400/MD	2/11/2013	51597	CAFETERIA HELPER	N	BC02	01	T	B	0.50	5,192	0.50	16,614
EDN150/FA	2/11/2013	601891	SPEC ED TEACHER	Certificated	T02	05	T	A			1.00	32,222
EDN400/MD	2/11/2013	38202	CAFETERIA HELPER	N	BC02	01	T	B			0.50	16,614
EDN100/AA	2/11/2013	67416	SECONDARY TEACHER	Certificated	T03	05	P	A	1.00	43,822	1.00	45,909
EDN100/AA	2/11/2013	800710	OFFICE ASSISTANT III	N	SR08	03	P	A	1.00	26,700	1.00	13,327
EDN300/UA	2/11/2013	36699	SECRETARY IV	N	SR18	03	P	A	1.00	42,817	1.00	37,968
EDN100/CN	2/11/2013	59815	PERSONNEL CLERK IV	N	SR11	03	T	A			1.00	14,969
EDN150/FA	2/13/2013	52714	EDUC ASST II	Y	SR10	03	P	A	1.00	29,561	1.00	23,130
EDN150/FA	2/13/2013	69805	SPEC ED TCHR/PRE-SCHOOL	Certificated	T03	05	P	A			1.00	53,990
EDN150/FA	2/13/2013	58941	EDUC ASST I	Y	SR08	03	P	A	0.50	14,193	0.50	6,664
EDN150/YG	2/13/2013	801817	SOCIAL WORKER IV	N	SR22	13	P	A			1.00	23,663
EDN100/AA	2/14/2013	802940	EDUC ASST I	Y	SR08	03	T	A			1.00	13,327
EDN100/AA	2/14/2013	802939	EDUC ASST I	Y	SR08	03	T	A			1.00	13,327
EDN150/YC	2/14/2013	58289	CLINICAL PSYCHOLOGIST V	N	SR24	13	P	A	1.00	60,939	1.00	51,312
EDN100/AA	2/15/2013	50469	SCHOOL CUSTODIAN II	N	BC02	01	P	A	0.50	16,614	0.50	16,614
EDN150/FA	2/15/2013	75985	GEN EDUC/ARTICLE VI TCHR	Certificated	T03	05	P	A	1.00	46,157	1.00	53,990
EDN100/AA	2/15/2013	16473	SCHOOL CUSTODIAN II	N	BC02	01	P	A	0.50	16,614	0.50	16,614
EDN150/FA	2/19/2013	57461	EDUC ASST III	Y	SR12	03	P	A	0.75	18,237	0.75	18,773
EDN150/FA	2/19/2013	57575	EDUC ASST I	Y	SR08	03	T	A	0.87	21,276	0.88	18,716
EDN150/YG	2/19/2013	802284	EDUC ASST III	Y	SR12	03	T	A			1.00	25,030
EDN100/AA	2/19/2013	802936	DP USER SUPPORT TECH II	N	SR15	03	T	A			1.00	17,528
EDN150/YC	2/19/2013	58639	BEHAVIORAL HLTH SPCLT III	N	SR20	13	T	A	1.00	42,066	1.00	42,132
EDN100/AA	2/19/2013	22580	SCHOOL CUSTODIAN II	N	BC02	01	P	A	1.00	33,228	1.00	33,228
EDN100/AA	2/19/2013	603415	ELEM TEACHER	Certificated	T03	05	T	A			1.00	45,909
EDN150/FA	2/19/2013	55070	EDUC ASST I	Y	SR08	03	P	A	1.00	24,314	1.00	13,327
EDN100/AA	2/19/2013	45107	SCHOOL CUSTODIAN II	N	BC02	01	P	A	1.00	33,228	1.00	33,228
EDN400/MD	2/19/2013	801482	CAFETERIA HELPER	N	BC02	01	T	B			0.50	8,629
EDN100/AA	2/19/2013	604332	ELEM TEACHER	Certificated	T02	05	T	A			0.50	21,255
EDN400/MD	2/19/2013	39638	CAFETERIA HELPER	N	BC02	01	T	B			0.50	16,614
EDN150/FA	2/19/2013	603713	SPEC ED TEACHER	Certificated	T03	05	T	A			1.00	45,909
EDN150/FA	2/19/2013	75926	GEN EDUC/ARTICLE VI TCHR	Certificated	T02	05	P	A	1.00	46,157	1.00	42,509
EDN150/FA	2/19/2013	37289	EDUC ASST I	Y	SR08	03	P	A	1.00	26,248	1.00	21,390
EDN100/AA	2/19/2013	29415	SCHOOL HEALTH AIDE	N	SR09	03	P	A	1.00	22,852	1.00	18,078
EDN150/FA	2/19/2013	54989	EDUC ASST I	Y	SR08	03	P	A	0.75	21,289	0.75	9,995
EDN150/YC	2/19/2013	58409	BEHAVIORAL SPECIALIST III	N	SR20	13	P	A	1.00	53,264	1.00	21,881

Department of Education
New Hires

Table 16

<u>Prog ID/Org</u>	<u>New Hire Effective Date</u>	<u>Position Number</u>	<u>Position Title</u>	<u>Exempt (Y/N)</u>	<u>SR Level</u>	<u>BU Code</u>	<u>T/P</u>	<u>MOF</u>	<u>Budgeted FTE</u>	<u>Budgeted Salary</u>	<u>Actual FTE</u>	<u>Actual Salary</u>
EDN300/KF	2/19/2013	349	PRE AUDIT CLERK III	N	SR15	03	P	A	1.00	30,335	1.00	33,756
EDN150/FA	2/19/2013	75467	SPEC ED TEACHER	Certificated	T02	05	T	A	1.00	42,602	1.00	42,509
EDN150/FA	2/19/2013	64310	SPEC ED TCHR/PRE-SCHOOL	Certificated	T02	05	P	A	1.00	63,653	1.00	42,509
EDN400/MD	2/19/2013	58589	CAFETERIA HELPER	N	BC02	01	T	B	0.50	5,192	0.50	16,614
EDN150/NB	2/19/2013	802449	EDUC ASST I	Y	SR08	03	T	N			1.00	13,327
EDN100/AA	2/19/2013	603524	ELEM TEACHER	Certificated	T03	05	T	A			0.50	22,955
EDN300/KF	2/19/2013	37525	PRE AUDIT CLERK II	N	SR13	03	P	A	1.00	31,510	1.00	16,211
EDN150/NB	2/20/2013	802374	EDUC ASST I	Y	SR08	03	T	N			1.00	13,327
EDN100/AA	2/20/2013	802708	SCHOOL CUSTODIAN II	N	BC02	01	T	A			0.50	16,614
EDN150/FA	2/22/2013	75865	SPEC ED TEACHER	Certificated	T03	05	P	A	1.00	73,666	1.00	45,909
EDN150/FA	2/22/2013	73214	SPEC ED TCHR/PRE-SCHOOL	Certificated	T02	05	P	A	1.00	47,851	1.00	42,509
EDN150/FA	2/22/2013	603638	GEN EDUC/ARTICLE VI TCHR	Certificated	T02	05	T	A			1.00	32,222
EDN150/FA	2/22/2013	66134	SPEC ED TEACHER	Certificated	T02	05	T	A	1.00	43,369	1.00	32,222
EDN150/FA	2/22/2013	602311	SPEC ED TEACHER	Certificated	T02	05	T	A			1.00	42,509
EDN100/AA	2/22/2013	602449	ELEM TEACHER	Certificated	T02	05	T	A			1.00	42,509
EDN100/AA	2/25/2013	73692	COUNSELOR	Certificated	T03	05	P	A	1.00	59,010	1.00	53,990
EDN100/AA	2/25/2013	69668	ELEM TEACHER	Certificated	T02	05	P	A	1.00	55,434	1.00	42,509
EDN100/AA	2/26/2013	55691	EDUC ASST III	Y	SR12	03	T	A	1.00	28,209	1.00	25,030
EDN150/FA	3/1/2013	57265	EDUC ASST I	Y	SR08	03	T	A	0.75	18,950	0.75	16,043
EDN100/AA	3/1/2013	36296	OFFICE ASSISTANT III	N	SR08	03	P	A	1.00	28,836	1.00	13,327
EDN150/FA	3/1/2013	47592	EDUC ASST I	Y	SR08	03	P	A	1.00	28,385	1.00	21,390
EDN400/MD	3/1/2013	49645	CAFETERIA HELPER	N	BC02	01	T	B			0.50	16,614
EDN400/MD	3/1/2013	42841	CAFETERIA HELPER	N	BC02	01	T	B	0.50	5,192	0.50	16,614
EDN100/AA	3/1/2013	802549	SCHOOL CUSTODIAN II	N	BC02	01	T	A			1.00	33,228
EDN400/MD	3/1/2013	32340	CAFETERIA HELPER	N	BC02	01	P	B	0.50	5,192	0.50	16,614
EDN100/AA	3/1/2013	802920	EDUC ASST II	Y	SR10	03	T	A			1.00	23,130
EDN100/AA	3/1/2013	59520	SCHOOL CUSTODIAN II	N	BC02	01	P	A	0.50	16,614	0.50	16,614
EDN150/NB	3/1/2013	800182	EDUC ASST III	Y	SR12	03	T	N			1.00	25,030
EDN100/AA	3/1/2013	802548	SCHOOL CUSTODIAN II	N	BC02	01	T	A			0.50	16,614
EDN400/MD	3/1/2013	802405	CAFETERIA HELPER	N	BC02	01	T	B			0.50	16,614
EDN150/FA	3/1/2013	51220	EDUC ASST II	Y	SR10	03	P	A	0.50	12,158	0.50	11,565
EDN400/MD	3/4/2013	55496	CAFETERIA HELPER	N	BC02	01	T	B	0.50	5,192	0.50	16,614
EDN150/FA	3/4/2013	52517	EDUC ASST II	Y	SR10	03	P	A	1.00	27,326	1.00	23,130
EDN150/FA	3/4/2013	57344	EDUC ASST II	Y	SR10	03	P	A	0.75	20,495	0.75	17,348
EDN100/AA	3/4/2013	802572	ACCOUNT CLERK II	N	SR08	03	P	A			0.50	12,834
EDN100/AA	3/5/2013	802949	SCHOOL SECURITY ATTENDANT	N	SR07	03	T	A			1.00	12,798
EDN150/FA	3/7/2013	54991	EDUC ASST III	Y	SR12	03	P	A	0.50	12,158	0.50	12,515
EDN150/NB	3/7/2013	58141	EDUC ASST III	Y	SR12	03	T	N			1.00	25,030
EDN100/AA	3/8/2013	26564	SCHOOL CUSTODIAN II	N	BC02	01	P	A	1.00	33,228	0.50	16,614
EDN150/FA	3/11/2013	43959	EDUC ASST II	Y	SR10	03	P	A	1.00	24,314	1.00	23,130
EDN100/AA	3/11/2013	29473	SCHOOL HEALTH AIDE	N	SR09	03	P	A	1.00	17,401	1.00	13,867
EDN100/AA	3/11/2013	802921	EDUC ASST III	Y	SR12	03	T	A			1.00	25,030
EDN150/FA	3/11/2013	58006	EDUC ASST II	Y	SR10	03	T	A	0.75	18,237	0.75	17,348
EDN150/YC	3/11/2013	29155	SCHOOL PSYCHOLOGIST	Y	SR24	13	P	A	1.00	54,194	1.00	26,644
EDN100/AA	3/12/2013	16392	SCHOOL CUSTODIAN II	N	BC02	01	P	A	0.50	16,614	0.50	16,614
EDN100/DB	3/12/2013	603678	DOE COMM SPEC II	Certificated	E07	06	T	N			1.00	77,069
EDN150/FA	3/13/2013	57260	EDUC ASST II	Y	SR10	03	T	A	0.75	18,237	0.50	11,565

Department of Education
New Hires

Table 16

<u>Prog ID/Org</u>	<u>New Hire Effective Date</u>	<u>Position Number</u>	<u>Position Title</u>	<u>Exempt (Y/N)</u>	<u>SR Level</u>	<u>BU Code</u>	<u>T/P</u>	<u>MOF</u>	<u>Budgeted FTE</u>	<u>Budgeted Salary</u>	<u>Actual FTE</u>	<u>Actual Salary</u>
EDN150/FA	3/13/2013	800897	EDUC ASST III	Y	SR12	03	T	A	1.00	25,266	1.00	25,030
EDN100/AA	3/13/2013	16270	SCHOOL CUSTODIAN II	N	BC02	01	P	A	0.50	16,614	0.50	16,614
EDN150/YC	3/14/2013	58497	BEHAVIORAL HLTH SPCLT III	N	SR20	13	P	A	1.00	53,264	1.00	21,881
EDN100/AA	3/15/2013	802947	DP USER SUPPORT TECH II	N	SR15	03	T	A			1.00	17,528
EDN100/AA	3/18/2013	18132	SCHOOL CUSTODIAN II	N	BC02	01	P	A	0.50	16,614	0.50	8,629
EDN400/MD	3/18/2013	42812	CAFETERIA HELPER	N	BC02	01	T	B			0.50	16,614
EDN100/AA	3/18/2013	56598	OFFICE ASSISTANT III	N	SR08	03	P	A	1.00	25,668	1.00	25,668
EDN400/MD	3/18/2013	9536	CAFETERIA HELPER	N	BC02	01	T	B	0.50	5,192	0.50	16,614
EDN400/MD	3/18/2013	9518	CAFETERIA HELPER	N	BC02	01	T	B	0.50	5,192	0.50	16,614
EDN100/AA	3/18/2013	51944	ACCOUNT CLERK III	N	SR11	03	P	A	1.00	31,212	1.00	14,969
EDN300/UA	3/18/2013	14886	AUTOMATED SYSTS EQUIP TECH I	N	BC14	01	P	A	1.00	47,704	1.00	53,532
EDN150/YC	3/18/2013	58093	SOCIAL WORKER IV	N	SR22	13	P	A	1.00	45,533	1.00	23,663
EDN400/OC	3/18/2013	45351	OFFICE ASSISTANT III	N	SR08	03	P	A	1.00	26,951	1.00	13,327
EDN100/AA	3/19/2013	16543	SCHOOL CUSTODIAN II	N	BC02	01	P	A	0.50	16,614	0.50	8,629
EDN150/YC	3/19/2013	58656	BEHAVIORAL HLTH SPCLT III	N	SR20	13	P	A	1.00	45,533	1.00	42,132
EDN300/KO	3/25/2013	14738	PERSONNEL CLERK IV	N	SR11	03	P	A	1.00	27,918	1.00	28,836
EDN100/AA	3/25/2013	29441	SCHOOL HEALTH AIDE	N	SR09	03	P	A	1.00	19,575	1.00	13,867
EDN300/KO	3/25/2013	60046	ASST SUPT,HUMAN RES	N	E00	06	P	A	1.00	103,308	1.00	120,000
EDN150/FA	3/27/2013	802840	EDUC ASST I	Y	SR08	03	T	A			0.75	9,995
EDN150/FA	3/27/2013	58974	EDUC ASST II	Y	SR10	03	P	A	1.00	27,326	1.00	23,130
EDN150/FA	3/27/2013	55518	EDUC ASST III	Y	SR12	03	P	A	1.00	25,266	1.00	25,030
EDN400/MD	3/27/2013	42853	CAFETERIA HELPER	N	BC02	01	T	B			0.50	16,614
EDN150/FA	3/27/2013	802833	EDUC ASST I	Y	SR08	03	T	A			1.00	21,390
EDN150/FA	3/27/2013	801903	EDUC ASST III	Y	SR12	03	P	A			0.75	18,773
EDN150/YC	3/27/2013	59148	BEHAVIORAL HLTH SPCLT III	N	SR20	13	P	A	1.00	42,066	1.00	42,132
EDN150/NB	3/27/2013	800358	EDUC ASST II	Y	SR10	03	T	N			0.50	11,565
EDN150/NB	3/27/2013	802631	EDUC ASST III	Y	SR12	03	T	N			1.00	25,030
EDN400/MD	3/27/2013	802834	CAFETERIA HELPER	N	BC02	01	T	B			0.50	16,614
EDN150/NB	4/1/2013	79311	EDUCATIONAL SPEC II	Y	E07	06	T	N	1.00	80,350	1.00	77,069
EDN150/FA	4/1/2013	53137	EDUC ASST II	Y	SR10	03	T	A			0.50	11,565
EDN400/MD	4/1/2013	42840	CAFETERIA HELPER	N	BC02	01	T	B	0.50	5,192	0.50	16,614
EDN150/FA	4/1/2013	56749	EDUC ASST II	Y	SR10	03	T	A	0.75	18,237	0.75	17,348
EDN400/MD	4/1/2013	801946	CAFETERIA HELPER	N	BC02	01	T	B			0.50	16,614
EDN400/MD	4/1/2013	41748	CAFETERIA HELPER	N	BC02	01	P	B	0.50	5,192	0.50	16,614
EDN100/AA	4/1/2013	802796	SCHOOL CUSTODIAN II	N	BC02	01	T	A			1.00	33,228
EDN150/FA	4/1/2013	32157	EDUC ASST III	Y	SR12	03	P	A	1.00	31,959	1.00	25,030
EDN150/FA	4/1/2013	52942	EDUC ASST II	Y	SR10	03	P	A	0.75	18,237	0.75	17,348
EDN400/MD	4/1/2013	802849	CAFETERIA HELPER	N	BC02	01	T	B			0.50	16,614
EDN150/FA	4/1/2013	52612	EDUC ASST II	Y	SR10	03	P	A	0.50	12,633	0.50	11,565
EDN300/KF	4/1/2013	22467	ACCOUNTANT IV	N	SR22	13	P	A	1.00	47,945	1.00	45,576
EDN300/KO	4/1/2013	15437	PERSONNEL CLERK V	N	SR13	03	P	A	1.00	29,128	1.00	16,211
EDN150/FA	4/2/2013	802794	EDUC ASST I	Y	SR08	03	T	A			0.50	6,664
EDN150/FA	4/2/2013	800558	EDUC ASST I	Y	SR08	03	T	A	1.00	24,314	1.00	13,327
EDN100/AA	4/2/2013	800734	SCHOOL CUSTODIAN II	N	BC02	01	T	A	0.50	16,614	0.50	8,629
EDN150/FA	4/2/2013	58933	EDUC ASST I	Y	SR08	03	P	A	0.75	18,237	0.75	9,995
EDN100/AA	4/2/2013	22418	SCHOOL CUSTODIAN II	N	BC02	01	P	A	0.50	16,614	0.50	8,629
EDN150/YG	4/2/2013	801871	EDUC ASST I	Y	SR08	03	T	A			1.00	13,327

Department of Education
New Hires

Table 16

Prog ID/Org	New Hire Effective Date	Position Number	Position Title	Exempt (Y/N)	SR Level	BU Code	T/P	MOF	Budgeted FTE	Budgeted Salary	Actual FTE	Actual Salary
EDN100/AA	4/2/2013	801298	SCHOOL SECURITY ATTENDANT	N	SR07	03	T	A	1.00	21,444	1.00	12,798
EDN150/FA	4/2/2013	57467	EDUC ASST I	Y	SR08	03	T	A	0.75	20,495	0.75	9,995
EDN150/YG	4/2/2013	801717	EDUC ASST I	Y	SR08	03	T	A			1.00	13,327
EDN150/SA	4/2/2013	33093	SPEECH PATHOLOGIST II	Y	SR18	13	P	A	1.00	51,891	1.00	38,988
EDN100/AA	4/2/2013	54879	OFFICE ASSISTANT III	N	SR08	03	T	A	0.50	12,834	0.50	6,664
EDN100/AA	4/2/2013	802885	OFFICE ASSISTANT I	N	SR04	03	T	A			0.50	5,697
EDN150/FA	4/2/2013	802792	EDUC ASST I	Y	SR08	03	T	A			0.75	9,995
EDN150/YG	4/2/2013	801880	EDUC ASST I	Y	SR08	03	T	A			1.00	13,327
EDN300/KC	4/2/2013	802509	SECRETARY III	N	SR16	03	P	A			1.00	18,209
EDN150/YG	4/4/2013	802382	EDUC ASST I	Y	SR08	03	T	A			1.00	13,327
EDN100/AA	4/8/2013	56449	OFFICE ASSISTANT III	N	SR08	03	P	A	0.50	16,212	0.50	6,664
EDN100/DB	4/8/2013	603459	COMPLEX ACADEMIC OFFICER	Certificated	E07	06	T	N			1.00	77,069
EDN150/YG	4/8/2013	802600	EDUC ASST I	Y	SR08	03	T	A			1.00	13,327
EDN100/AA	4/8/2013	54884	OFFICE ASSISTANT III	N	SR08	03	T	A	1.00	25,668	1.00	13,327
EDN400/MD	4/8/2013	52984	CAFETERIA HELPER	N	BC02	01	T	B	0.50	5,192	0.50	16,614
EDN300/KO	4/8/2013	59625	PERSONNEL MGMT SPECIALIST V	N	SR24	13	P	A	1.00	53,922	1.00	26,644
EDN150/FA	4/15/2013	57335	EDUC ASST III	Y	SR12	03	P	A	0.75	20,495	0.75	18,773
EDN400/MC	4/15/2013	36109	OFFICE ASSISTANT III	N	SR08	03	T	N	1.00	25,668	1.00	13,327
EDN400/MD	4/16/2013	55387	CAFETERIA HELPER	N	BC02	01	T	B	0.50	5,192	0.50	16,614
EDN100/AA	4/16/2013	26562	SCHOOL CUSTODIAN II	N	BC02	01	P	A	0.50	16,614	0.50	16,614
EDN150/FA	4/16/2013	57577	EDUC ASST I	Y	SR08	03	T	A	0.75	18,950	0.75	16,043
EDN150/FA	4/16/2013	802789	EDUC ASST III	Y	SR12	03	T	A			0.75	18,773
EDN400/MD	4/16/2013	51595	CAFETERIA HELPER	N	BC02	01	T	B	0.50	5,192	0.50	16,614
EDN400/MD	4/16/2013	55512	CAFETERIA HELPER	N	BC02	01	T	B	0.50	5,192	0.50	16,614
EDN400/MD	4/16/2013	42954	CAFETERIA HELPER	N	BC02	01	T	B			0.50	16,614
EDN150/YC	4/16/2013	59140	OFFICE ASSISTANT III	N	SR08	03	T	A	0.50	12,322	0.50	6,664
EDN100/AA	4/16/2013	800930	OFFICE ASSISTANT III	N	SR08	03	T	A	0.50	12,834	0.50	12,834
EDN400/MD	4/16/2013	11379	SCHOOL BAKER	N	BC06	01	P	B	1.00	12,012	1.00	38,436
EDN400/MD	4/16/2013	14631	SCHOOL BAKER	N	BC06	01	P	B	1.00	12,012	1.00	38,436
EDN400/OC	4/16/2013	801862	EDUC ASST III	Y	SR12	03	T	A			1.00	48,960
EDN400/MD	4/16/2013	23887	CAFETERIA HELPER	N	BC02	01	P	B	0.50	5,192	0.50	16,614
EDN400/MD	4/17/2013	47320	CAFETERIA HELPER	N	BC02	01	T	B	0.50	5,192	0.50	16,614
EDN300/KF	4/18/2013	603697	FISCAL SPECIALIST II	Certificated	E07	06	P	A			1.00	77,069
EDN100/AA	4/19/2013	110654	SCHOOL HEALTH AIDE	N	SR09	03	P	A	1.00	20,342	1.00	13,867
EDN100/AA	4/22/2013	802473	DP USER SUPPORT TECH II	N	SR15	03	T	A			1.00	17,528
EDN150/NB	4/22/2013	802452	EDUC ASST I	Y	SR08	03	T	N			1.00	13,327
EDN150/YC	4/22/2013	59132	OFFICE ASSISTANT III	N	SR08	03	T	A	0.50	13,861	0.50	6,664
EDN300/KO	4/22/2013	58579	PERSONNEL CLERK V	N	SR13	03	P	A	1.00	30,193	1.00	16,211
EDN400/MD	4/24/2013	802413	CAFETERIA HELPER	N	BC02	01	T	B			0.50	16,614
EDN150/YC	4/26/2013	58526	BEHAVIORAL HLTH SPCLT III	N	SR20	13	T	A	1.00	43,761	1.00	21,881
EDN150/FA	4/29/2013	38551	EDUC ASST II	Y	SR10	03	P	A	1.00	30,736	1.00	23,130
EDN200/GJ	4/30/2013	57804	OFFICE ASSISTANT III	N	SR08	03	P	A	1.00	32,192	1.00	13,327
EDN150/FA	4/30/2013	801450	EDUC ASST II	Y	SR10	03	P	A	1.00	24,314	1.00	23,130
EDN100/AA	5/1/2013	48484	SCHOOL CUSTODIAN II	N	BC02	01	P	A	0.50	16,614	0.50	16,614
EDN400/MD	5/1/2013	22462	CAFETERIA HELPER	N	BC02	01	P	B	1.00	10,385	0.50	16,614
EDN400/MD	5/1/2013	59511	CAFETERIA HELPER	N	BC02	01	T	B	0.50	5,192	0.50	16,614
EDN100/AA	5/1/2013	22652	SCHOOL CUSTODIAN II	N	BC02	01	P	A	0.50	16,614	0.50	8,629

Department of Education
New Hires

Table 16

<u>Prog ID/Org</u>	<u>New Hire Effective Date</u>	<u>Position Number</u>	<u>Position Title</u>	<u>Exempt (Y/N)</u>	<u>SR Level</u>	<u>BU Code</u>	<u>T/P</u>	<u>MOF</u>	<u>Budgeted FTE</u>	<u>Budgeted Salary</u>	<u>Actual FTE</u>	<u>Actual Salary</u>
EDN100/AA	5/1/2013	39942	OFFICE ASSISTANT III	N	SR08	03	P	A	1.00	31,212	1.00	25,668
EDN400/MD	5/1/2013	41865	CAFETERIA HELPER	N	BC02	01	T	B	0.50	5,192	0.50	16,614
EDN400/OC	5/1/2013	17101	WELDER I	N	BC10	01	P	A	1.00	41,524	1.00	24,008
EDN400/MD	5/1/2013	54514	CAFETERIA HELPER	N	BC02	01	T	B	0.50	5,192	0.50	16,614
EDN100/AA	5/1/2013	33425	OFFICE ASSISTANT III	N	SR08	03	P	A	1.00	31,212	1.00	13,327
EDN400/MD	5/1/2013	23119	CAFETERIA HELPER	N	BC02	01	T	B	0.50	5,192	0.50	16,614
EDN150/SA	5/1/2013	30408	SPEECH PATHOLOGIST II	Y	SR18	13	P	A	1.00	60,973	1.00	38,988
EDN400/OC	5/1/2013	17151	PLUMBER II	N	WS10	01	P	A	1.00	46,740	1.00	48,960
EDN100/AA	5/1/2013	802208	EDUC ASST III	Y	SR12	03	T	A			0.75	18,773
EDN150/FA	5/2/2013	800061	EDUC ASST II	Y	SR10	03	P	A	1.00	26,248	1.00	23,130
EDN500/PC	5/3/2013	48277	OFFICE ASSISTANT III	N	SR08	03	P	A			1.00	13,327
EDN200/GH	5/7/2013	57913	DATA PROCSSG SYSTS ANAL IV	N	SR22	13	P	B	1.00	43,274	1.00	49,332
EDN150/YC	5/7/2013	58651	BEHAVIORAL HLTH SPCLT III	N	SR20	03	T	A	1.00	42,066	1.00	21,881
EDN400/MD	5/7/2013	39439	CAFETERIA HELPER	N	BC02	01	T	B	0.50	5,192	0.50	16,614
EDN400/MD	5/13/2013	2047	SCHOOL FOOD SERVICES MGR II	N	F106	02	P	B			1.00	42,576
EDN100/CB	5/13/2013	59997	OFFICE ASSISTANT III	N	SR08	03	T	A	1.00	23,666	1.00	13,327
EDN300/KC	5/15/2013	802509	SECRETARY III	N	SR16	03	P	A			1.00	18,209
EDN400/MD	5/16/2013	30053	CAFETERIA HELPER	N	BC02	01	T	B			0.50	16,614
EDN400/MD	5/16/2013	44469	CAFETERIA HELPER	N	BC02	01	T	B			0.50	16,614
EDN100/AA	5/16/2013	18815	SCHOOL CUSTODIAN II	N	BC02	01	P	A	0.50	16,614	0.50	16,614
EDN400/MD	5/16/2013	28163	CAFETERIA HELPER	N	BC02	01	T	B			0.50	16,614
EDN150/FA	5/16/2013	55411	EDUC ASST II	Y	SR10	03	P	A	0.50	14,193	0.50	11,565
EDN150/FA	5/16/2013	55152	EDUC ASST II	Y	SR10	03	P	A	1.00	26,248	1.00	23,130
EDN400/MD	5/16/2013	54661	CAFETERIA HELPER	N	BC02	01	T	B	0.50	5,192	0.50	16,614
EDN400/MD	5/20/2013	58620	CAFETERIA HELPER	N	BC02	01	T	B	0.50	5,192	0.50	16,614
EDN400/OC	5/20/2013	16788	POWER MOWER OPERATOR I	N	BC03	01	P	A	1.00	30,682	1.00	17,744
EDN100/AA	5/20/2013	33122	SCHOOL SECURITY ATTENDANT	N	SR07	03	P	A	1.00	24,148	1.00	20,540
EDN150/YC	5/20/2013	58078	HUMAN SVCS PROF IV	N	SR22	13	P	A	1.00	42,066	1.00	23,663
EDN100/AA	5/20/2013	23338	OFFICE ASSISTANT III	N	SR08	03	P	A	1.00	32,424	1.00	25,668
EDN400/OC	5/20/2013	16807	POWER MOWER OPERATOR I	N	BC03	01	P	A	1.00	30,682	1.00	17,744
EDN300/UA	5/20/2013	47863	DATA PROCSSG SYSTS ANAL IV	N	SR22	13	P	A	1.00	40,614	1.00	23,663
EDN400/MD	5/22/2013	32437	CAFETERIA HELPER	N	BC02	01	T	B			0.50	16,614
EDN100/AA	6/3/2013	51946	SCHOOL CUSTODIAN II	N	BC02	01	P	A	0.50	16,614	0.50	16,614
EDN100/AA	6/3/2013	18823	SCHOOL CUSTODIAN II	N	BC02	01	P	A	0.50	16,614	0.50	16,614
EDN400/MD	6/3/2013	11324	SCHOOL BAKER	N	BC06	01	P	B	1.00	12,012	1.00	38,436
EDN100/AA	6/3/2013	36388	OFFICE ASSISTANT III	N	SR08	03	P	A	1.00	37,968	1.00	13,327
EDN400/OB	6/3/2013	600019	OSFSS EXECUTIVE ASSISTANT	Certificated	E10	06	P	A			1.00	87,340
EDN100/AA	6/3/2013	36296	OFFICE ASSISTANT III	N	SR08	03	P	A	1.00	28,836	1.00	25,668
EDN150/YG	6/3/2013	801071	EDUC ASST I	Y	SR08	03	P	A			1.00	13,327
EDN100/AA	6/5/2013	22050	SCHOOL CUSTODIAN II	N	BC02	01	P	A	0.50	16,614	0.50	16,614
EDN100/AA	6/10/2013	802972	OFFICE ASSISTANT III	N	SR08	03	P	A			1.00	13,327
EDN100/AA	6/10/2013	45157	OFFICE ASSISTANT II	N	SR06	03	P	A	1.00	26,700	1.00	23,688
EDN100/AA	6/12/2013	802628	SCHOOL CUSTODIAN III	N	WS02	01	P	A			1.00	18,457
EDN100/AA	6/13/2013	54850	OFFICE ASSISTANT II	N	SR06	03	T	A	0.50	15,018	0.50	11,844
EDN100/AA	6/17/2013	45104	SCHOOL CUSTODIAN II	N	BC02	01	P	A	0.50	16,614	0.50	16,614
EDN400/OC	6/17/2013	16808	POWER MOWER OPERATOR I	N	BC03	01	P	A	1.00	30,682	1.00	17,744
EDN150/YG	6/17/2013	801200	BEHAVIORAL HLTH SPCLT IV	N	SR22	13	P	A	1.00	42,049	1.00	51,312

Department of Education
New Hires

Table 16

<u>Prog ID/Org</u>	<u>New Hire Effective Date</u>	<u>Position Number</u>	<u>Position Title</u>	<u>Exempt (Y/N)</u>	<u>SR Level</u>	<u>BU Code</u>	<u>T/P</u>	<u>MOF</u>	<u>Budgeted FTE</u>	<u>Budgeted Salary</u>	<u>Actual FTE</u>	<u>Actual Salary</u>
EDN100/AA	6/17/2013	14699	OFFICE ASSISTANT III	N	SR08	03	P	A	1.00	35,064	1.00	25,668
EDN150/YC	6/17/2013	29133	SCHOOL PSYCHOLOGIST	Y	SR24	13	P	A	1.00	52,605	1.00	51,312
EDN150/YC	6/17/2013	58406	BEHAVIORAL HLTH SPCLT IV	N	SR22	13	P	A	1.00	53,264	1.00	49,332
EDN200/GN	6/17/2013	57974	ADMINISTRATIVE SERVICES ASST	N	SR22	13	P	A	1.00	46,947	1.00	23,663
EDN100/BS	6/17/2013	72057	ROTC INSTRUCTOR	Certificated	ROTC	05	T	A	1.00	74,050	1.00	122,536
EDN400/OC	6/18/2013	34313	ENGINEER III	N	SR22	13	P	A	1.00	63,026	1.00	23,663
EDN100/AA	6/19/2013	18821	SCHOOL CUSTODIAN II	N	BC02	01	P	A	0.50	16,614	0.50	16,614
EDN100/DB	6/19/2013	801055	PERSONNEL CLERK V	N	SR13	03	T	N			1.00	16,211
EDN100/DB	6/20/2013	801056	PERSONNEL CLERK V	N	SR13	03	T	N			1.00	16,211
EDN200/GP	6/24/2013	48871	RESEARCH STATISTICIAN IV	N	SR22	13	P	A			1.00	23,663
EDN200/GN	6/25/2013	32337	BILINGUAL/BICULTURAL S/H ASST	Y	SR11	03	T	A	1.00	38,773	0.50	14,418
EDN100/AA	7/1/2013	65745	SECONDARY TEACHER	Certificated	T02	05	P	A	1.00	45,579	1.00	33,169
EDN100/AA	7/1/2013	27302	OFFICE ASSISTANT III	N	SR08	03	P	A	1.00	25,101	1.00	25,668
EDN150/FA	7/1/2013	74584	SPEC ED TEACHER	Certificated	T02	05	P	A	1.00	40,381	1.00	33,169
EDN100/AA	7/1/2013	72635	ELEM TEACHER	Certificated	T02	05	P	A	1.00	48,356	1.00	43,759
EDN150/FA	7/1/2013	71689	SPEC ED TEACHER	Certificated	T02	05	P	A	1.00	46,268	1.00	43,759
EDN150/NB	7/1/2013	79796	DIST OFF TCHR	Certificated	T02	05	T	N			1.00	43,759
EDN100/AA	7/1/2013	56414	OFFICE ASSISTANT III	N	SR08	03	P	A	1.00	28,199	1.00	25,668
EDN100/AA	7/1/2013	63654	ELEM TEACHER	Certificated	T03	05	P	A	1.00	55,614	1.00	47,259
EDN100/AA	7/1/2013	68162	SECONDARY TEACHER	Certificated	T03	05	P	A	1.00	59,388	1.00	47,259
EDN100/AA	7/1/2013	71956	SECONDARY TEACHER	Certificated	T03	05	P	A	1.00	49,806	1.00	47,259
EDN100/AA	7/1/2013	63998	SECONDARY TEACHER	Certificated	T03	05	P	A	1.00	46,948	1.00	47,259
EDN150/NB	7/1/2013	79650	12-MO DIST OFF TCHR	Certificated	T03	05	T	N			1.00	58,269
EDN150/FA	7/1/2013	601886	SPEC ED TEACHER	Certificated	T02	05	T	A	1.00	43,611	1.00	33,169
EDN100/AA	7/1/2013	72313	ELEM TEACHER	Certificated	T02	05	P	A	1.00	52,302	1.00	43,759
EDN200/GJ	7/1/2013	600884	COHORT INTERN	Certificated	E01	06	T	A			1.00	58,482
EDN300/KF	7/1/2013	600107	OFS EXECUTIVE ASSISTANT	Certificated	E10	06	P	A			1.00	87,340
EDN150/YC	7/1/2013	59003	SCHOOL PSYCHOLOGIST	Y	SR24	13	T	A	1.00	54,194	1.00	53,364
EDN100/AA	7/1/2013	55751	OFFICE ASSISTANT III	N	SR08	03	P	A	1.00	25,101	1.00	25,668
EDN200/GJ	7/1/2013	57804	OFFICE ASSISTANT III	N	SR08	03	P	A	1.00	32,192	1.00	25,668
EDN100/BS	7/1/2013	73403	ROTC INSTRUCTOR	Certificated	ROTC	05	T	A	1.00	104,164	1.00	101,099
EDN100/BS	7/1/2013	73417	ROTC INSTRUCTOR	Certificated	ROTC	05	T	A	1.00	95,404	1.00	109,472
EDN200/GJ	7/1/2013	600881	COHORT INTERN	Certificated	E01	06	T	A			1.00	58,482
EDN200/GJ	7/1/2013	600882	COHORT INTERN	Certificated	E01	06	T	A			1.00	58,482
EDN200/GJ	7/1/2013	600883	COHORT INTERN	Certificated	E01	06	T	A			1.00	58,482
EDN400/OC	7/2/2013	16795	HEAVY TRUCK DRIVER	N	BC07	01	P	A	1.00	35,898	1.00	20,758
EDN150/SA	7/2/2013	30431	SPEECH PATHOLOGIST II	Y	SR18	13	P	A	1.00	54,027	1.00	21,049
EDN100/AA	7/2/2013	802985	DP USER SUPPORT TECH II	N	SR15	03	T	A			1.00	17,528
EDN100/AA	7/2/2013	802791	DP USER SUPPORT TECH II	N	SR15	03	T	A			1.00	17,528
EDN150/YC	7/2/2013	58101	OFFICE ASSISTANT III	N	SR08	03	T	A	1.00	23,691	1.00	13,327
EDN100/AA	7/2/2013	25383	SCHOOL CUSTODIAN II	N	BC02	01	P	A	0.50	16,247	0.50	8,629
EDN150/YG	7/2/2013	802597	BEHAVIORAL HLTH SPCLT III	N	SR20	13	T	A			1.00	22,745
EDN400/MB	7/2/2013	802361	SCHOOL LUNCH SERVICES SUPVR	N	SR24	13	T	B			1.00	27,713
EDN400/OC	7/2/2013	37312	CLERICAL SUPERVISOR III	N	SR14	04	P	A	1.00	29,120	1.00	16,837
EDN400/OC	7/2/2013	16792	POWER MOWER OPERATOR I	N	BC03	01	P	A	1.00	30,682	1.00	17,744
EDN300/KO	7/2/2013	19240	PERSONNEL CLERK V	N	SR13	03	P	A	1.00	38,080	1.00	16,211
EDN300/KO	7/5/2013	15437	PERSONNEL CLERK V	N	SR13	03	P	A	1.00	34,108	1.00	16,211

Prog ID/Org	New Hire Effective Date	Position Number	Position Title	Exempt (Y/N)	SR Level	BU Code	T/P	MOF	Budgeted FTE	Budgeted Salary	Actual FTE	Actual Salary
EDN400/MD	7/8/2013	9336	SCHOOL COOK II	N	BC06	01	P	B	1.00	38,436	1.00	38,436
EDN150/FA	7/8/2013	74130	SPEC ED TEACHER	Certificated	T03	05	P	A	1.00	56,823	1.00	48,678
EDN400/MD	7/8/2013	9500	SCHOOL COOK II	N	BC06	01	P	B	1.00	38,436	1.00	38,436
EDN100/AA	7/8/2013	31686	SCHOOL CUSTODIAN II	N	BC02	01	P	A	1.00	32,494	1.00	33,228
EDN300/UA	7/8/2013	35337	SECRETARY II	N	SR14	03	P	A	1.00	29,080	1.00	35,064
EDN150/YG	7/8/2013	801833	EDUC ASST I	Y	SR08	03	T	A			1.00	13,327
EDN300/KD	7/10/2013	100026	PRIVATE SECRETARY II	N	SR22	03	P	A	1.00	52,385	1.00	54,012
EDN200/GN	7/11/2013	58666	BILINGUAL/BICULTURAL S/H ASST	Y	SR11	03	T	A	1.00	29,453	0.50	14,418
EDN100/AA	7/12/2013	802981	OFFICE ASSISTANT III	N	SR08	03	P	A			1.00	13,327
EDN100/AA	7/12/2013	802972	OFFICE ASSISTANT III	N	SR08	03	P	A			1.00	13,327
EDN300/UA	7/15/2013	46737	COMPUTER PROGRAMMER III	N	SR20	13	P	A	1.00	42,606	1.00	43,812
EDN100/AA	7/15/2013	802825	OFFICE ASSISTANT III	N	SR08	03	T	A			0.50	6,664
EDN100/AA	7/16/2013	42039	OFFICE ASSISTANT III	N	SR08	03	P	A	1.00	28,199	1.00	13,327
EDN100/AA	7/16/2013	36568	OFFICE ASSISTANT III	N	SR08	03	P	A	0.50	13,055	0.50	12,834
EDN100/DB	7/16/2013	600454	ELEM TEACHER	Certificated	T02	05	T	N			1.00	50,760
EDN150/YC	7/16/2013	32307	SCHOOL PSYCHOLOGIST	Y	SR24	13	T	A			1.00	27,713
EDN100/AA	7/16/2013	802983	OFFICE ASSISTANT II	N	SR06	03	T	A			1.00	23,688
EDN150/FA	7/16/2013	67443	SPEC ED TEACHER	Certificated	T02	05	P	A	1.00	51,255	1.00	50,760
EDN100/AA	7/16/2013	600031	ELEM TEACHER	Certificated	T03	05	T	A	1.00	45,579	1.00	54,820
EDN100/AA	7/16/2013	45146	OFFICE ASSISTANT II	N	SR06	03	P	A	1.00	31,708	1.00	23,688
EDN100/DB	7/16/2013	600452	ELEM TEACHER	Certificated	T02	05	T	N			1.00	50,760
EDN100/AA	7/16/2013	802697	OFFICE ASSISTANT III	N	SR08	03	T	A			0.50	6,664
EDN100/AA	7/16/2013	802777	DP USER SUPPORT TECH II	N	SR15	03	T	A			1.00	17,528
EDN150/YC	7/16/2013	59637	SCHOOL PSYCHOLOGIST	Y	SR24	13	T	A	1.00	54,194	1.00	53,364
EDN400/OC	7/16/2013	17154	PLUMBER I	N	BC10	01	P	A	1.00	41,524	1.00	46,236
EDN150/FB	7/16/2013	72957F	SPECIAL SCH TEACHER	Certificated	T02	05	T	A	1.00	41,952	1.00	50,760
EDN400/MD	7/16/2013	9423	SCHOOL COOK II	N	BC06	01	P	B	1.00	38,436	1.00	38,436
EDN150/YC	7/16/2013	58635	BEHAVIORAL HLTH SPCLT IV	N	SR22	13	P	A	1.00	42,066	1.00	49,308
EDN100/AA	7/16/2013	56583	OFFICE ASSISTANT II	N	SR06	03	P	A	1.00	25,101	1.00	23,688
EDN150/FA	7/16/2013	64481	SPEC ED TEACHER	Certificated	T03	05	P	A			1.00	54,820
EDN150/FB	7/16/2013	75020	SPECIAL SCH TEACHER	Certificated	T03	05	P	A	1.00	39,795	1.00	56,466
EDN150/FA	7/16/2013	74427	SPEC ED TEACHER	Certificated	T02	05	P	A	1.00	50,043	1.00	50,760
EDN100/AA	7/16/2013	64515	ELEM TEACHER	Certificated	T02	05	P	A	1.00	57,657	1.00	50,760
EDN150/FA	7/16/2013	64480	GEN EDUC/ARTICLE VI TCHR	Certificated	T02	05	T	A	1.00	37,867	1.00	50,760
EDN300/KF	7/16/2013	3899	ACCOUNTANT IV	N	SR22	13	P	A	1.00	40,957	1.00	47,400
EDN150/FA	7/16/2013	603642	SPEC ED TEACHER	Certificated	T02	05	T	A			1.00	38,476
EDN100/DB	7/16/2013	600453	ELEM TEACHER	Certificated	T02	05	T	N			1.00	38,476
EDN100/AA	7/16/2013	62336	ELEM TEACHER	Certificated	T02	05	P	A	1.00	44,774	1.00	50,760
EDN100/AA	7/16/2013	68770	ELEM TEACHER	Certificated	T03	05	P	A	1.00	77,421	1.00	54,820
EDN100/AA	7/16/2013	802979	SCHOOL CUSTODIAN II	N	BC02	01	P	A			0.50	8,629
EDN100/AA	7/16/2013	74057	ELEM TEACHER	Certificated	T02	05	P	A	1.00	48,356	1.00	50,760
EDN150/FA	7/16/2013	62390	SPEC ED TEACHER	Certificated	T03	05	P	A	1.00	62,091	1.00	56,466
EDN150/FA	7/16/2013	66449	SPEC ED TEACHER	Certificated	T02	05	P	A	1.00	52,756	1.00	50,760
EDN150/FB	7/16/2013	60268	SPECIAL SCH TEACHER	Certificated	T02	05	P	A	1.00	44,268	1.00	50,760
EDN150/YC	7/16/2013	58668	CLINICAL PSYCHOLOGIST VI	N	SR26	13	P	A	1.00	60,939	1.00	29,970
EDN150/YC	7/16/2013	58542	BEHAVIORAL HLTH SPCLT III	N	SR20	13	T	A	1.00	42,066	1.00	22,745
EDN100/AA	7/18/2013	40782	OFFICE ASSISTANT III	N	SR08	03	P	A	1.00	29,373	1.00	25,668

<u>Prog ID/Org</u>	<u>New Hire Effective Date</u>	<u>Position Number</u>	<u>Position Title</u>	<u>Exempt (Y/N)</u>	<u>SR Level</u>	<u>BU Code</u>	<u>T/P</u>	<u>MOF</u>	<u>Budgeted FTE</u>	<u>Budgeted Salary</u>	<u>Actual FTE</u>	<u>Actual Salary</u>
EDN100/AA	7/22/2013	40512	OFFICE ASSISTANT II	N	SR06	03	P	A	1.00	23,165	1.00	23,688
EDN100/AA	7/22/2013	36271	ACCOUNT CLERK IV	N	SR13	03	P	A	1.00	30,523	1.00	16,211
EDN200/GN	7/22/2013	29998	BILINGUAL/BICULTURAL S/H ASST	Y	SR11	03	T	A	0.50	13,097	0.50	14,418
EDN100/BM	7/22/2013	800799	ATHLETIC HLTH CARE TRAINER	Y	SR22	13	P	A	1.00	42,073	1.00	24,613
EDN100/DB	7/23/2013	801471	OFFICE ASSISTANT III	N	SR08	03	T	N			0.50	12,834
EDN100/AA	7/24/2013	21697	SCHOOL CUSTODIAN II	N	BC02	01	P	A	0.50	16,247	0.50	16,614
EDN100/AA	7/24/2013	66550	ELEM TEACHER	Certificated	T02	05	P	A	1.00	53,870	1.00	43,759
EDN150/YC	7/25/2013	800422	SCHOOL PSYCHOLOGIST	Y	SR24	13	P	A	1.00	62,235	1.00	53,364
EDN100/AA	7/26/2013	18678	SCHOOL CUSTODIAN II	N	BC02	01	P	A	0.50	16,247	0.50	16,614
EDN400/MD	7/26/2013	8537	SCHOOL FOOD SERVICES MGR III	N	F206	02	P	A	1.00	37,068	1.00	47,136
EDN100/AA	7/29/2013	802816	LIBRARY ASSISTANT III	N	SR07	03	T	A			0.50	6,399
EDN100/BM	7/29/2013	800531	ATHLETIC HLTH CARE TRAINER	Y	SR22	13	P	A	1.00	42,073	1.00	24,613
EDN100/AA	7/29/2013	25027	SCHOOL CUSTODIAN II	N	BC02	01	P	A	0.50	16,247	0.50	16,614
EDN150/YC	7/29/2013	802950	CLINICAL PSYCHOLOGIST VI	N	SR26	13	T	A			1.00	29,970
EDN100/AA	7/29/2013	802473	DP USER SUPPORT TECH II	N	SR15	03	T	A			1.00	17,528
EDN150/YC	7/29/2013	59137	OFFICE ASSISTANT III	N	SR08	03	T	A	0.50	11,846	0.50	6,664
EDN150/FA	7/30/2013	69689	SPEC ED TEACHER	Certificated	T02	05	P	A	1.00	43,611	1.00	43,759
EDN100/AA	7/30/2013	601206	SECONDARY TEACHER	Certificated	T02	05	T	A	1.00	42,204	1.00	43,759
EDN100/AA	7/30/2013	75956	COUNSELOR	Certificated	T03	05	P	A	1.00	45,579	1.00	47,259
EDN100/AA	7/30/2013	69195	SECONDARY TEACHER	Certificated	T02	05	P	A	1.00	45,579	1.00	43,759
EDN150/FA	7/30/2013	72783	SPEC ED TEACHER	Certificated	T02	05	P	A	1.00	52,044	1.00	33,169
EDN150/FA	7/30/2013	67098	SPEC ED TEACHER	Certificated	T02	05	P	A	1.00	49,561	1.00	43,759
EDN100/AA	7/30/2013	66596	ELEM TEACHER	Certificated	T03	05	P	A	1.00	63,004	1.00	47,259
EDN100/AA	7/30/2013	600477	COUNSELOR	Certificated	T03	05	T	A			1.00	47,259
EDN100/AA	7/30/2013	603538	SECONDARY TEACHER	Certificated	T02	05	T	A			1.00	43,759
EDN100/AA	7/30/2013	601760	ELEM TEACHER	Certificated	T02	05	T	A	1.00	31,990	1.00	33,169
EDN100/AA	7/30/2013	68616	SECONDARY TEACHER	Certificated	T02	05	P	A	1.00	78,443	1.00	43,759
EDN150/FA	7/30/2013	73244	SPEC ED TEACHER	Certificated	T02	05	P	A			1.00	33,169
EDN100/AA	7/30/2013	71040	ELEM TEACHER	Certificated	T03	05	P	A	1.00	45,579	1.00	47,259
EDN100/AA	7/30/2013	63506	SECONDARY TEACHER	Certificated	T02	05	P	A	1.00	61,168	1.00	43,759
EDN100/AA	7/30/2013	600635	SECONDARY TEACHER	Certificated	T03	05	T	A	1.00	48,356	1.00	47,259
EDN100/AA	7/30/2013	67231	ELEM TEACHER	Certificated	T03	05	P	A	1.00	64,893	1.00	47,259
EDN100/AA	7/30/2013	61288	ELEM TEACHER	Certificated	T03	05	P	A	1.00	50,290	1.00	47,259
EDN100/AA	7/30/2013	601016	ELEM TEACHER	Certificated	T02	05	T	A			1.00	33,169
EDN100/AA	7/30/2013	64911	SECONDARY TEACHER	Certificated	T03	05	P	A	1.00	45,579	1.00	47,259
EDN100/DB	7/30/2013	603186	DIST OFF TCHR	Certificated	T03	05	T	N			1.00	48,678
EDN100/AA	7/30/2013	29377	SCHOOL HEALTH AIDE	N	SR09	03	P	A	1.00	22,413	1.00	13,867
EDN150/FA	7/30/2013	603475	SPEC ED TEACHER	Certificated	T03	05	T	A			1.00	47,259
EDN100/AA	7/30/2013	67057	SECONDARY TEACHER	Certificated	T03	05	P	A	1.00	47,404	1.00	47,259
EDN150/FA	7/30/2013	600463	SPEC ED TEACHER	Certificated	T02	05	T	A			1.00	33,169
EDN150/FA	7/30/2013	73579	SPEC ED TEACHER	Certificated	T02	05	P	A	1.00	40,381	1.00	33,169
EDN100/DB	7/30/2013	600101	ELEM TEACHER	Certificated	T03	05	T	N			1.00	47,259
EDN100/AA	7/30/2013	72346	ELEM TEACHER	Certificated	T03	05	P	A	1.00	70,911	1.00	47,259
EDN100/AA	7/30/2013	69914	SECONDARY TEACHER	Certificated	T03	05	P	A	1.00	51,556	1.00	47,259
EDN100/AA	7/30/2013	64369	SECONDARY TEACHER	Certificated	T02	05	P	A	1.00	46,846	1.00	43,759
EDN100/AA	7/30/2013	67892	ELEM TEACHER	Certificated	T03	05	P	A	1.00	45,579	1.00	47,259
EDN150/FA	7/30/2013	65425	SPEC ED TEACHER	Certificated	T02	05	P	A			1.00	33,169

<u>Prog ID/Org</u>	<u>New Hire Effective Date</u>	<u>Position Number</u>	<u>Position Title</u>	<u>Exempt (Y/N)</u>	<u>SR Level</u>	<u>BU Code</u>	<u>T/P</u>	<u>MOF</u>	<u>Budgeted FTE</u>	<u>Budgeted Salary</u>	<u>Actual FTE</u>	<u>Actual Salary</u>
EDN100/AA	7/30/2013	63684	SECONDARY TEACHER	Certificated	T03	05	T	A			1.00	48,678
EDN100/AA	7/30/2013	601223	ELEM TEACHER	Certificated	T03	05	T	A			1.00	47,259
EDN100/AA	7/30/2013	61661	SECONDARY TEACHER	Certificated	T02	05	P	A	1.00	59,388	1.00	43,759
EDN100/AA	7/30/2013	68233	ELEM TEACHER	Certificated	T02	05	P	A	1.00	60,632	1.00	43,759
EDN100/AA	7/30/2013	71946	ELEM TEACHER	Certificated	T03	05	P	A	1.00	57,706	1.00	47,259
EDN100/AA	7/30/2013	64570	SECONDARY TEACHER	Certificated	T02	05	P	A	1.00	39,671	1.00	33,169
EDN100/AA	7/30/2013	601222	ELEM TEACHER	Certificated	T02	05	T	A			1.00	43,759
EDN150/FA	7/30/2013	73256	SPEC ED TEACHER	Certificated	T02	05	T	A	1.00	40,381	1.00	33,169
EDN150/FA	7/30/2013	64466	GEN EDUC/ARTICLE VI TCHR	Certificated	T03	05	P	A	1.00	61,115	1.00	47,259
EDN100/BJ	7/30/2013	601356	SECONDARY TEACHER	Certificated	T02	05	T	A			1.00	43,759
EDN150/FA	7/30/2013	76154	SPEC ED TEACHER	Certificated	T02	05	P	A	1.00	50,043	1.00	33,169
EDN100/AA	7/30/2013	73879	SECONDARY TEACHER	Certificated	T03	05	P	A	1.00	45,579	1.00	47,259
EDN100/AA	7/30/2013	63638	ELEM TEACHER	Certificated	T03	05	P	A	1.00	61,168	1.00	48,678
EDN100/AA	7/30/2013	601538	ELEM TEACHER	Certificated	T03	05	T	A	1.00	45,579	1.00	47,259
EDN100/AA	7/30/2013	60642	ELEM TEACHER	Certificated	T02	05	P	A	1.00	42,204	1.00	43,759
EDN100/AA	7/30/2013	66505	SECONDARY TEACHER	Certificated	T03	05	P	A	1.00	45,579	1.00	47,259
EDN100/AA	7/30/2013	64105	SECONDARY TEACHER	Certificated	T03	05	P	A	1.00	63,004	1.00	38,004
EDN100/AA	7/30/2013	63366	ELEM TEACHER	Certificated	T03	05	P	A	1.00	46,948	1.00	47,259
EDN100/AA	7/30/2013	604238	SECONDARY TEACHER	Certificated	T03	05	T	A			1.00	47,259
EDN100/AA	7/30/2013	604426	SECONDARY TEACHER	Certificated	T03	05	T	A			1.00	47,259
EDN150/FA	7/30/2013	600460	SPEC ED TEACHER	Certificated	T02	05	T	A			1.00	43,759
EDN100/AA	7/30/2013	71399	COUNSELOR	Certificated	T03	05	T	A	1.00	45,579	1.00	47,259
EDN100/AA	7/30/2013	73556	SECONDARY TEACHER	Certificated	T03	05	P	A	1.00	46,948	1.00	47,259
EDN100/AA	7/30/2013	65219	ELEM TEACHER	Certificated	T03	05	P	A	1.00	53,870	1.00	48,678
EDN100/BJ	7/30/2013	73419	SPECIAL SCH TEACHER	Certificated	T03	05	T	A	1.00	46,253	1.00	47,259
EDN100/AA	7/30/2013	61745	SECONDARY TEACHER	Certificated	T02	05	P	A	1.00	53,870	1.00	45,072
EDN100/AA	7/30/2013	601198	ELEM TEACHER	Certificated	T03	05	T	A	1.00	42,204	1.00	47,259
EDN100/AA	7/30/2013	67144	ELEM TEACHER	Certificated	T03	05	P	A	1.00	54,393	1.00	48,678
EDN100/AA	7/30/2013	67225	SECONDARY TEACHER	Certificated	T02	05	P	A	1.00	58,300	1.00	45,072
EDN150/FA	7/30/2013	66868	SPEC ED TEACHER	Certificated	T03	05	P	A	1.00	40,381	1.00	48,678
EDN100/AA	7/30/2013	69519	ELEM TEACHER	Certificated	T03	05	P	A	1.00	42,204	1.00	48,678
EDN100/AA	7/30/2013	604211	SECONDARY TEACHER	Certificated	T03	05	T	A			1.00	48,678
EDN100/AA	7/30/2013	66323	SECONDARY TEACHER	Certificated	T03	05	P	A	1.00	48,356	1.00	47,259
EDN100/AA	7/30/2013	603585	ELEM TEACHER	Certificated	T02	05	T	A			1.00	43,759
EDN150/FA	7/30/2013	65402	GEN EDUC/ARTICLE VI TCHR	Certificated	T02	05	P	A	1.00	53,478	1.00	43,759
EDN100/AA	7/30/2013	60234	SECONDARY TEACHER	Certificated	T03	05	P	A	1.00	53,353	1.00	48,678
EDN150/FA	7/30/2013	600465	SPEC ED TEACHER	Certificated	T02	05	T	A			1.00	33,169
EDN100/AA	7/30/2013	62789	ELEM TEACHER	Certificated	T03	05	P	A	1.00	42,204	1.00	47,259
EDN100/AA	7/30/2013	63786	SECONDARY TEACHER	Certificated	T03	05	P	A	1.00	49,622	1.00	47,259
EDN100/AA	7/30/2013	601082	ELEM TEACHER	Certificated	T02	05	T	A			1.00	43,759
EDN100/AA	7/30/2013	62823	SECONDARY TEACHER	Certificated	T02	05	P	A	1.00	61,168	1.00	33,169
EDN100/AA	7/30/2013	601189	ELEM TEACHER	Certificated	T03	05	T	A	1.00	42,204	1.00	47,259
EDN100/AA	7/30/2013	72314	ELEM TEACHER	Certificated	T02	05	P	A	1.00	45,579	1.00	43,759
EDN100/AA	7/30/2013	62558	SECONDARY TEACHER	Certificated	T03	05	P	A	1.00	45,579	1.00	47,259
EDN100/AA	7/30/2013	600379	SECONDARY TEACHER	Certificated	T03	05	T	A	1.00	46,601	1.00	48,678
EDN100/AA	7/30/2013	71990	ELEM TEACHER	Certificated	T02	05	P	A	1.00	54,393	1.00	43,759
EDN100/AA	7/30/2013	63864	ELEM TEACHER	Certificated	T03	05	P	A	1.00	64,026	1.00	47,259

Department of Education
New Hires

Table 16

<u>Prog ID/Org</u>	<u>New Hire Effective Date</u>	<u>Position Number</u>	<u>Position Title</u>	<u>Exempt (Y/N)</u>	<u>SR Level</u>	<u>BU Code</u>	<u>T/P</u>	<u>MOF</u>	<u>Budgeted FTE</u>	<u>Budgeted Salary</u>	<u>Actual FTE</u>	<u>Actual Salary</u>
EDN100/AA	7/30/2013	69821	ELEM TEACHER	Certificated	T03	05	P	A	1.00	43,470	1.00	47,259
EDN100/AA	7/30/2013	602684	ELEM TEACHER	Certificated	T02	05	T	A			1.00	43,759
EDN100/DB	7/30/2013	79914	ELEM TEACHER	Certificated	T02	05	T	N			1.00	43,759
EDN150/FA	7/30/2013	75927	GEN EDUC/ARTICLE VI TCHR	Certificated	T02	05	P	A	1.00	40,285	1.00	43,759
EDN100/AA	7/30/2013	67952	ELEM TEACHER	Certificated	T02	05	T	A	1.00	48,356	1.00	43,759
EDN100/AA	7/30/2013	67267	ELEM TEACHER	Certificated	T03	05	P	A	1.00	58,679	1.00	47,259
EDN150/FA	7/30/2013	67743	SPEC ED TEACHER	Certificated	T03	05	P	A	1.00	57,801	1.00	47,259
EDN150/FA	7/30/2013	74556	SPEC ED TEACHER	Certificated	T02	05	P	A	1.00	55,167	1.00	45,072
EDN100/AA	7/30/2013	67473	ELEM TEACHER	Certificated	T02	05	T	A	1.00	42,204	1.00	43,759
EDN100/AA	7/30/2013	29300	SCHOOL HEALTH AIDE	N	SR09	03	P	A	1.00	28,369	1.00	18,078
EDN100/AA	7/30/2013	29441	SCHOOL HEALTH AIDE	N	SR09	03	P	A	1.00	20,762	1.00	13,867
EDN100/AA	7/30/2013	603870	ELEM TEACHER	Certificated	T02	05	T	A			1.00	43,759
EDN100/AA	7/30/2013	64850	ELEM TEACHER	Certificated	T03	05	P	A	1.00	66,841	1.00	47,259
EDN100/AA	7/30/2013	68581	SECONDARY TEACHER	Certificated	T02	05	P	A	1.00	46,948	1.00	43,759
EDN100/AA	7/30/2013	65679	ELEM TEACHER	Certificated	T02	05	P	A	1.00	78,443	1.00	43,759
EDN100/AA	7/30/2013	62824	ELEM TEACHER	Certificated	T02	05	T	A	1.00	50,290	1.00	43,759
EDN150/FA	7/30/2013	604246	SPEC ED TEACHER	Certificated	T02	05	T	A			1.00	33,169
EDN100/AA	7/30/2013	67533	ELEM TEACHER	Certificated	T02	05	T	A	1.00	52,302	1.00	43,759
EDN150/FA	7/30/2013	600664	SPEC ED TEACHER	Certificated	T02	05	T	A			1.00	43,759
EDN100/AA	7/30/2013	71300	SECONDARY TEACHER	Certificated	T03	05	P	A	1.00	50,290	1.00	48,678
EDN100/AA	7/30/2013	75331	COUNSELOR/HIGH RISK	Certificated	T03	05	P	A	1.00	47,969	1.00	47,259
EDN150/FA	7/30/2013	74254	SPEC ED TEACHER	Certificated	T03	05	P	A	1.00	43,611	1.00	47,259
EDN100/AA	7/30/2013	73548	SECONDARY TEACHER	Certificated	T02	05	P	A	1.00	48,356	1.00	33,169
EDN100/AA	7/30/2013	603668	ELEM TEACHER	Certificated	T02	05	T	A			1.00	43,759
EDN100/AA	7/30/2013	62022	SECONDARY TEACHER	Certificated	T02	05	P	A	1.00	57,000	1.00	43,759
EDN150/FA	7/30/2013	73916	SPEC ED TEACHER	Certificated	T03	05	P	A	1.00	48,118	1.00	47,259
EDN100/AA	7/30/2013	71173	ELEM TEACHER	Certificated	T02	05	P	A	1.00	57,706	1.00	43,759
EDN100/AA	7/30/2013	63745	SECONDARY TEACHER	Certificated	T02	05	P	A	1.00	50,290	1.00	33,169
EDN100/AA	7/30/2013	60535	COUNSELOR	Certificated	T02	05	P	A	1.00	45,579	1.00	43,759
EDN100/AA	7/30/2013	64133	COUNSELOR	Certificated	T03	05	P	A	1.00	65,915	1.00	47,259
EDN100/AA	7/30/2013	601191	ELEM TEACHER	Certificated	T02	05	T	A			1.00	43,759
EDN150/FA	7/30/2013	72611	SPEC ED TEACHER	Certificated	T03	05	P	A	1.00	44,920	1.00	48,678
EDN100/AA	7/30/2013	600323	ELEM TEACHER	Certificated	T03	05	T	A	1.00	42,204	1.00	47,259
EDN100/AA	7/30/2013	65705	ELEM TEACHER	Certificated	T03	05	P	A	1.00	48,356	1.00	47,259
EDN100/AA	7/30/2013	66762	ELEM TEACHER	Certificated	T02	05	P	A	1.00	63,004	1.00	43,759
EDN150/FA	7/30/2013	603471	SPEC ED TCHR/PRE-SCHOOL	Certificated	T03	05	T	A			1.00	47,259
EDN150/FA	7/30/2013	75513	SPEC ED TCHR/PRE-SCHOOL	Certificated	T03	05	T	A	1.00	41,593	1.00	47,259
EDN100/AA	7/30/2013	600665	ELEM TEACHER	Certificated	T02	05	T	A			1.00	43,759
EDN100/AA	7/30/2013	604240	SECONDARY TEACHER	Certificated	T07	05	T	A			1.00	56,350
EDN100/AA	7/30/2013	68150	ELEM TEACHER	Certificated	T02	05	P	A	1.00	66,058	1.00	43,759
EDN100/AA	7/30/2013	61957	SECONDARY TEACHER	Certificated	T03	05	P	A	1.00	44,774	1.00	47,259
EDN150/FA	7/30/2013	602342	SPEC ED TEACHER	Certificated	T02	05	T	A	1.00	30,609	1.00	43,759
EDN100/AA	7/30/2013	603081	SECONDARY TEACHER	Certificated	T03	05	T	A			1.00	47,259
EDN150/FA	7/30/2013	65192	SPEC ED TEACHER	Certificated	T03	05	P	A	1.00	41,593	1.00	47,259
EDN150/FA	7/30/2013	64913	GEN EDUC/ARTICLE VI TCHR	Certificated	T02	05	T	A	1.00	57,663	1.00	43,759
EDN150/FA	7/30/2013	603224	SPEC ED TEACHER	Certificated	T02	05	T	A			1.00	33,169
EDN100/AA	7/30/2013	600672	ELEM TEACHER	Certificated	T03	05	T	A			1.00	47,259

<u>Prog ID/Org</u>	<u>New Hire Effective Date</u>	<u>Position Number</u>	<u>Position Title</u>	<u>Exempt (Y/N)</u>	<u>SR Level</u>	<u>BU Code</u>	<u>T/P</u>	<u>MOF</u>	<u>Budgeted FTE</u>	<u>Budgeted Salary</u>	<u>Actual FTE</u>	<u>Actual Salary</u>
EDN100/AA	7/30/2013	73158	COUNSELOR	Certificated	T03	05	P	A	1.00	77,421	1.00	47,259
EDN100/AA	7/30/2013	62040	ELEM TEACHER	Certificated	T02	05	P	A	1.00	59,388	1.00	43,759
EDN100/AA	7/30/2013	604432	ELEM TEACHER	Certificated	T02	05	T	A			1.00	43,759
EDN100/AA	7/30/2013	62914	SECONDARY TEACHER	Certificated	T03	05	T	A	1.00	46,601	1.00	48,678
EDN100/AA	7/30/2013	802989	SCHOOL HEALTH AIDE	N	SR09	03	P	A			1.00	13,867
EDN100/AA	7/30/2013	600438	10-MO STUDENT SVCS COORD	Certificated	T02	05	T	A	1.00	45,579	1.00	33,169
EDN100/AA	7/30/2013	71501	ELEM TEACHER	Certificated	T02	05	T	A	1.00	59,388	1.00	43,759
EDN100/AA	7/30/2013	603884	SECONDARY TEACHER	Certificated	T02	05	T	A			1.00	43,759
EDN100/AA	7/30/2013	64007	ELEM TEACHER	Certificated	T02	05	P	A	1.00	45,579	1.00	43,759
EDN150/FA	7/30/2013	66083	SPEC ED TEACHER	Certificated	T02	05	P	A	1.00	42,840	1.00	33,169
EDN100/AA	7/30/2013	602603	ELEM TEACHER	Certificated	T03	05	T	A			1.00	47,259
EDN100/AA	7/30/2013	600581	ELEM TEACHER	Certificated	T03	05	T	A			1.00	47,259
EDN100/AA	7/30/2013	67295	ELEM TEACHER	Certificated	T02	05	P	A	1.00	44,774	1.00	43,759
EDN150/FA	7/30/2013	75690	GEN EDUC/ARTICLE VI TCHR	Certificated	T02	05	P	A	1.00	46,157	1.00	33,169
EDN150/FA	7/30/2013	74641	SPEC ED TEACHER	Certificated	T02	05	P	A	1.00	40,381	1.00	43,759
EDN100/AA	7/30/2013	71335	SECONDARY TEACHER	Certificated	T03	05	P	A	1.00	51,312	1.00	48,678
EDN100/AA	7/30/2013	71206	ELEM TEACHER	Certificated	T02	05	P	A	1.00	69,783	1.00	43,759
EDN150/FA	7/30/2013	61392	SPEC ED TEACHER	Certificated	T02	05	P	A	1.00	65,872	1.00	43,759
EDN150/FA	7/30/2013	73290	SPEC ED TCHR/PRE-SCHOOL	Certificated	T02	05	P	A	1.00	75,540	1.00	33,169
EDN100/AA	7/30/2013	604127	ELEM TEACHER	Certificated	T02	05	T	A			1.00	43,759
EDN100/AA	7/30/2013	603389	SECONDARY TEACHER	Certificated	T03	05	T	A			1.00	47,259
EDN150/SA	7/30/2013	33046	SPEECH PATHOLOGIST IV	Y	SR22	13	P	A	1.00	64,848	1.00	47,400
EDN100/AA	7/30/2013	68929	SECONDARY TEACHER	Certificated	T02	05	P	A	1.00	51,312	1.00	43,759
EDN100/AA	7/30/2013	600656	ELEM TEACHER	Certificated	T02	05	T	A			1.00	45,072
EDN150/FA	7/30/2013	73497	SPEC ED TEACHER	Certificated	T02	05	P	A	1.00	42,840	1.00	43,759
EDN100/AA	7/30/2013	67676	ELEM TEACHER	Certificated	T02	05	P	A	1.00	78,443	1.00	33,169
EDN100/AA	7/30/2013	64649	ELEM TEACHER	Certificated	T02	05	P	A	1.00	53,568	1.00	43,759
EDN150/FA	7/30/2013	64073	SPEC ED TEACHER	Certificated	T02	05	P	A	1.00	71,096	1.00	43,759
EDN100/AA	7/30/2013	601006	SECONDARY TEACHER	Certificated	T02	05	T	A			0.50	21,879
EDN100/AA	7/30/2013	68908	SECONDARY TEACHER	Certificated	T02	05	P	A	1.00	52,302	1.00	43,759
EDN100/AA	7/30/2013	63351	ELEM TEACHER	Certificated	T02	05	P	A	1.00	46,040	1.00	43,759
EDN150/FA	7/30/2013	74912	GEN EDUC/ARTICLE VI TCHR	Certificated	T02	05	P	A	1.00	43,785	1.00	43,759
EDN100/AA	7/30/2013	69674	ELEM TEACHER	Certificated	T02	05	P	A	1.00	53,568	1.00	43,759
EDN100/AA	7/30/2013	76247	ELEM TEACHER	Certificated	T02	05	P	A	1.00	54,483	1.00	33,169
EDN100/AA	7/30/2013	65368	ELEM TEACHER	Certificated	T03	05	P	A	1.00	68,845	1.00	47,259
EDN100/AA	7/30/2013	600937	ELEM TEACHER	Certificated	T02	05	T	A	1.00	54,347	1.00	43,759
EDN150/FA	7/30/2013	604684	GEN EDUC/ARTICLE VI TCHR	Certificated	T03	05	T	A			1.00	47,259
EDN100/AA	7/30/2013	61409	ELEM TEACHER	Certificated	T02	05	T	A	1.00	39,671	1.00	43,759
EDN100/AA	7/30/2013	600564	SPEC ED TEACHER	Certificated	T02	05	T	A			1.00	43,759
EDN100/AA	7/30/2013	29310	SCHOOL HEALTH AIDE	N	SR09	03	P	A	1.00	18,456	1.00	13,867
EDN150/FA	7/30/2013	75497	GEN EDUC/ARTICLE VI TCHR	Certificated	T02	05	T	A	1.00	48,032	1.00	45,072
EDN100/AA	7/30/2013	62491	SECONDARY TEACHER	Certificated	T02	05	P	A	1.00	70,738	1.00	43,759
EDN100/AA	7/30/2013	71612	ELEM TEACHER	Certificated	T03	05	P	A	1.00	61,168	1.00	47,259
EDN150/FA	7/30/2013	64782	SPEC ED TEACHER	Certificated	T02	05	P	A	1.00	47,655	1.00	33,169
EDN100/AA	7/30/2013	600517	SECONDARY TEACHER	Certificated	T02	05	T	A	1.00	61,168	1.00	43,759
EDN100/AA	7/30/2013	602387	ELEM TEACHER	Certificated	T03	05	T	A			1.00	48,678
EDN100/AA	7/30/2013	604126	ELEM TEACHER	Certificated	T02	05	T	A			1.00	43,759

Department of Education
New Hires

Table 16

<u>Prog ID/Org</u>	<u>New Hire Effective Date</u>	<u>Position Number</u>	<u>Position Title</u>	<u>Exempt (Y/N)</u>	<u>SR Level</u>	<u>BU Code</u>	<u>T/P</u>	<u>MOF</u>	<u>Budgeted FTE</u>	<u>Budgeted Salary</u>	<u>Actual FTE</u>	<u>Actual Salary</u>
EDN100/AA	7/30/2013	600226	ELEM TEACHER	Certificated	T03	05	T	A	1.00	45,579	1.00	47,259
EDN100/AA	7/30/2013	72020	SECONDARY TEACHER	Certificated	T03	05	P	A	1.00	70,911	1.00	47,259
EDN150/FA	7/30/2013	62115	SPEC ED TEACHER	Certificated	T02	05	P	A	1.00	40,381	1.00	43,759
EDN150/FA	7/30/2013	66134	SPEC ED TEACHER	Certificated	T02	05	T	A	1.00	43,611	1.00	43,759
EDN100/AA	7/30/2013	74062	COUNSELOR	Certificated	T03	05	T	A	1.00	48,356	1.00	47,259
EDN100/AA	7/30/2013	601182	ELEM TEACHER	Certificated	T02	05	T	A			1.00	43,759
EDN100/AA	7/30/2013	69866	ELEM TEACHER	Certificated	T02	05	T	A	1.00	48,356	1.00	43,759
EDN100/AA	7/30/2013	602235	ELEM TEACHER	Certificated	T02	05	T	A			1.00	43,759
EDN150/FA	7/30/2013	600646	SPEC ED TEACHER	Certificated	T02	05	T	A			1.00	43,759
EDN100/AA	7/30/2013	604241	SECONDARY TEACHER	Certificated	T02	05	T	A			1.00	43,759
EDN150/FA	7/30/2013	76341	SPEC ED TEACHER	Certificated	T03	05	P	A	1.00	40,381	1.00	48,678
EDN100/AA	7/30/2013	63271	SECONDARY TEACHER	Certificated	T02	05	P	A	1.00	44,774	1.00	43,759
EDN100/AA	7/30/2013	68893	SECONDARY TEACHER	Certificated	T02	05	P	A	1.00	46,601	1.00	33,169
EDN100/AA	7/30/2013	601942	ELEM TEACHER	Certificated	T02	05	T	A	1.00	42,204	1.00	45,072
EDN150/FA	7/30/2013	73739	SPEC ED TEACHER	Certificated	T02	05	P	A	1.00	60,283	1.00	33,169
EDN100/AA	7/30/2013	601018	SECONDARY TEACHER	Certificated	T02	05	T	A			1.00	33,169
EDN100/AA	7/30/2013	600251	SECONDARY TEACHER	Certificated	T03	05	T	A	1.00	48,356	1.00	48,678
EDN100/AA	7/30/2013	74666	ELEM TEACHER	Certificated	T03	05	T	A	1.00	54,347	1.00	47,259
EDN150/FA	7/30/2013	73670	SPEC ED TEACHER	Certificated	T03	05	P	A	1.00	55,167	1.00	48,678
EDN100/AA	7/30/2013	62617	SECONDARY TEACHER	Certificated	T02	05	T	A	1.00	45,579	1.00	43,759
EDN100/AA	7/30/2013	69670	ELEM TEACHER	Certificated	T02	05	P	A	1.00	42,204	1.00	43,759
EDN150/FA	7/30/2013	60524	SPEC ED TEACHER	Certificated	T02	05	P	A	1.00	46,334	1.00	33,169
EDN150/FA	7/30/2013	71263	SPEC ED TEACHER	Certificated	T03	05	P	A	1.00	43,611	1.00	47,259
EDN100/AA	7/30/2013	68305	SECONDARY TEACHER	Certificated	T03	05	P	A	1.00	45,579	1.00	47,259
EDN100/AA	7/30/2013	600644	ELEM TEACHER	Certificated	T02	05	T	A	1.00	42,204	1.00	43,759
EDN150/FA	7/30/2013	603190	GEN EDUC/ARTICLE VI TCHR	Certificated	T02	05	T	A			1.00	43,759
EDN150/FA	7/30/2013	604005	SPEC ED TEACHER	Certificated	T02	05	T	A			1.00	43,759
EDN100/AA	7/30/2013	600666	ELEM TEACHER	Certificated	T02	05	T	A			1.00	43,759
EDN100/AA	7/30/2013	69364	ELEM TEACHER	Certificated	T02	05	P	A	1.00	71,933	1.00	43,759
EDN150/FA	7/30/2013	65034	SPEC ED TEACHER	Certificated	T03	05	T	A	1.00	55,167	1.00	47,259
EDN100/AA	7/30/2013	600559	ELEM TEACHER	Certificated	T02	05	T	A			1.00	43,759
EDN150/FA	7/30/2013	73401	SPEC ED TCHR/PRE-SCHOOL	Certificated	T02	05	P	A	1.00	52,044	1.00	43,759
EDN100/AA	7/30/2013	600668	ELEM TEACHER	Certificated	T02	05	T	A			1.00	43,759
EDN100/AA	7/30/2013	72730	SECONDARY TEACHER	Certificated	T02	05	P	A	1.00	43,226	1.00	43,759
EDN150/FA	7/30/2013	603242	SPEC ED TCHR/PRE-SCHOOL	Certificated	T02	05	T	A			1.00	43,759
EDN100/AA	7/30/2013	604423	ELEM TEACHER	Certificated	T03	05	T	A			1.00	47,259
EDN150/FA	7/30/2013	72264	SPEC ED TEACHER	Certificated	T02	05	P	A	1.00	44,920	1.00	43,759
EDN100/AA	7/30/2013	69611	ELEM TEACHER	Certificated	T02	05	P	A	1.00	50,290	1.00	43,759
EDN100/AA	7/30/2013	60164	ELEM TEACHER	Certificated	T02	05	P	A	1.00	42,204	1.00	43,759
EDN100/AA	7/30/2013	65032	ELEM TEACHER	Certificated	T03	05	P	A	1.00	61,168	1.00	47,259
EDN100/AA	7/30/2013	603397	ELEM TEACHER	Certificated	T02	05	T	A			1.00	43,759
EDN150/FA	7/30/2013	60700	GEN EDUC/ARTICLE VI TCHR	Certificated	T02	05	P	A			1.00	43,759
EDN100/AA	7/30/2013	600669	ELEM TEACHER	Certificated	T02	05	T	A			1.00	45,072
EDN100/BB	7/30/2013	63329	SECONDARY TEACHER	Certificated	T02	05	P	A	1.00	40,899	1.00	33,169
EDN150/FA	7/30/2013	62415	SPEC ED TEACHER	Certificated	T03	05	P	A	1.00	40,381	1.00	48,678
EDN100/AA	7/30/2013	68149	ELEM TEACHER	Certificated	T02	05	P	A	1.00	45,579	1.00	43,759
EDN100/AA	7/30/2013	66858	SECONDARY TEACHER	Certificated	T02	05	P	A	1.00	48,356	1.00	43,759

<u>Prog ID/Org</u>	<u>New Hire Effective Date</u>	<u>Position Number</u>	<u>Position Title</u>	<u>Exempt (Y/N)</u>	<u>SR Level</u>	<u>BU Code</u>	<u>T/P</u>	<u>MOF</u>	<u>Budgeted FTE</u>	<u>Budgeted Salary</u>	<u>Actual FTE</u>	<u>Actual Salary</u>
EDN100/AA	7/30/2013	603939	ELEM TEACHER	Certificated	T02	05	T	A			1.00	33,169
EDN100/AA	7/30/2013	601017	COUNSELOR	Certificated	T03	05	T	A			0.50	24,339
EDN100/AA	7/30/2013	66548	ELEM TEACHER	Certificated	T02	05	P	A	1.00	42,204	1.00	43,759
EDN150/FA	7/30/2013	72754	SPEC ED TEACHER	Certificated	T02	05	T	A	1.00	40,381	1.00	33,169
EDN100/AA	7/30/2013	65239	ELEM TEACHER	Certificated	T03	05	P	A	1.00	49,806	1.00	47,259
EDN100/AA	7/30/2013	62596	SECONDARY TEACHER	Certificated	T02	05	P	A	1.00	53,245	0.50	16,584
EDN100/AA	7/30/2013	29516	SCHOOL HEALTH AIDE	N	SR09	03	P	A	1.00	25,242	1.00	18,078
EDN100/AA	7/30/2013	65799	SECONDARY TEACHER	Certificated	T03	05	P	A	1.00	45,579	1.00	47,259
EDN100/BJ	7/30/2013	602029	SPEC ED TEACHER	Certificated	T02	05	T	A	1.00	30,599	1.00	33,169
EDN150/FA	7/30/2013	603830	SPEC ED TEACHER	Certificated	T02	05	T	A			1.00	45,072
EDN100/AA	7/30/2013	65801	SECONDARY TEACHER	Certificated	T02	05	P	A	1.00	48,356	1.00	43,759
EDN100/AA	7/30/2013	603039	SECONDARY TEACHER	Certificated	T02	05	T	A			1.00	45,072
EDN100/AA	7/30/2013	68615	ELEM TEACHER	Certificated	T02	05	P	A	1.00	59,388	1.00	45,072
EDN100/AA	7/30/2013	600088	ELEM TEACHER	Certificated	T03	05	T	A	1.00	45,579	1.00	48,678
EDN100/AA	7/30/2013	62572	SECONDARY TEACHER	Certificated	T02	05	P	A	1.00	53,353	1.00	33,169
EDN100/AA	7/30/2013	68297	SECONDARY TEACHER	Certificated	T03	05	P	A	1.00	73,038	1.00	47,259
EDN100/AA	7/30/2013	66827	SECONDARY TEACHER	Certificated	T03	05	P	A	1.00	77,421	1.00	47,259
EDN150/FA	7/30/2013	602215	GEN EDUC/ARTICLE VI TCHR	Certificated	T02	05	T	A	1.00	51,421	1.00	43,759
EDN150/FA	7/30/2013	65242	SPEC ED TEACHER	Certificated	T02	05	P	A	1.00	46,268	1.00	43,759
EDN150/FA	7/30/2013	74909	SPEC ED TEACHER	Certificated	T03	05	P	A	1.00	43,611	1.00	47,259
EDN100/AA	7/30/2013	75806	SECONDARY TEACHER	Certificated	T02	05	T	A	1.00	46,117	1.00	43,759
EDN100/AA	7/30/2013	602441	SECONDARY TEACHER	Certificated	T03	05	T	A	1.00	46,948	1.00	47,259
EDN100/AA	7/30/2013	60429	ELEM TEACHER	Certificated	T02	05	P	A	1.00	52,302	1.00	43,759
EDN150/FA	7/30/2013	75621	GEN EDUC/ARTICLE VI TCHR	Certificated	T03	05	T	A	1.00	56,011	1.00	47,259
EDN150/FA	7/30/2013	604330	SPEC ED TEACHER	Certificated	T03	05	T	A			1.00	48,678
EDN100/AA	7/30/2013	64536	SECONDARY TEACHER	Certificated	T03	05	P	A	1.00	48,356	1.00	48,678
EDN100/AA	7/30/2013	67922	ELEM TEACHER	Certificated	T02	05	P	A	1.00	56,601	1.00	43,759
EDN100/AA	7/30/2013	63015	ELEM TEACHER	Certificated	T02	05	P	A	1.00	61,168	1.00	43,759
EDN150/FA	7/30/2013	69324	GEN EDUC/ARTICLE VI TCHR	Certificated	T03	05	P	A	1.00	46,157	1.00	47,259
EDN100/AA	7/30/2013	604146	ELEM TEACHER	Certificated	T03	05	T	A			1.00	47,259
EDN100/AA	7/30/2013	604434	ELEM TEACHER	Certificated	T03	05	T	A			1.00	47,259
EDN100/AA	7/30/2013	66047	SECONDARY TEACHER	Certificated	T03	05	P	A	1.00	42,204	1.00	48,678
EDN100/AA	7/30/2013	67832	SECONDARY TEACHER	Certificated	T03	05	P	A	1.00	53,353	1.00	47,259
EDN100/AA	7/30/2013	66206	SECONDARY TEACHER	Certificated	T02	05	P	A	1.00	43,182	1.00	43,759
EDN100/AA	7/30/2013	602887	COUNSELOR	Certificated	T03	05	T	A			1.00	47,259
EDN100/AA	7/30/2013	601427	SECONDARY TEACHER	Certificated	T03	05	T	A	1.00	42,204	1.00	47,259
EDN100/AA	7/30/2013	62450	ELEM TEACHER	Certificated	T02	05	P	A	1.00	45,579	1.00	45,072
EDN150/FA	7/30/2013	75804	GEN EDUC/ARTICLE VI TCHR	Certificated	T02	05	P	A	1.00	46,157	1.00	33,169
EDN100/AA	7/30/2013	65060	ELEM TEACHER	Certificated	T02	05	P	A	1.00	39,671	1.00	43,759
EDN100/AA	7/30/2013	61126	ELEM TEACHER	Certificated	T02	05	P	A	1.00	42,204	1.00	43,759
EDN100/AA	7/30/2013	69076	SECONDARY TEACHER	Certificated	T03	05	P	A	1.00	42,204	1.00	48,678
EDN100/AA	7/30/2013	600683	ELEM TEACHER	Certificated	T03	05	T	A			1.00	48,678
EDN100/AA	7/30/2013	600054	ELEM TEACHER	Certificated	T02	05	T	A	1.00	42,204	1.00	43,759
EDN100/AA	7/30/2013	62227	ELEM TEACHER	Certificated	T02	05	P	A	1.00	50,778	1.00	43,759
EDN150/FA	7/30/2013	600458	SPEC ED TEACHER	Certificated	T03	05	T	A			1.00	47,259
EDN150/FA	7/30/2013	64236	SPEC ED TEACHER	Certificated	T02	05	P	A	1.00	56,823	1.00	33,169
EDN100/AA	7/30/2013	69820	ELEM TEACHER	Certificated	T02	05	T	A	1.00	50,290	1.00	45,072

<u>Prog ID/Org</u>	<u>New Hire Effective Date</u>	<u>Position Number</u>	<u>Position Title</u>	<u>Exempt (Y/N)</u>	<u>SR Level</u>	<u>BU Code</u>	<u>T/P</u>	<u>MOF</u>	<u>Budgeted FTE</u>	<u>Budgeted Salary</u>	<u>Actual FTE</u>	<u>Actual Salary</u>
EDN150/FA	7/30/2013	602486	GEN EDUC/ARTICLE VI TCHR	Certificated	T03	05	T	A	1.00	43,507	1.00	48,678
EDN100/AA	7/30/2013	66870	SECONDARY TEACHER	Certificated	T02	05	P	A	1.00	42,204	1.00	45,072
EDN100/AA	7/30/2013	603073	ELEM TEACHER	Certificated	T03	05	T	A			1.00	47,259
EDN100/AA	7/30/2013	602725	ELEM TEACHER	Certificated	T03	05	T	A			1.00	47,259
EDN100/AA	7/30/2013	66838	SECONDARY TEACHER	Certificated	T02	05	P	A	1.00	57,657	1.00	33,169
EDN150/FA	7/30/2013	75907	GEN EDUC/ARTICLE VI TCHR	Certificated	T02	05	P	A	1.00	37,867	1.00	33,169
EDN150/FA	7/30/2013	73673	SPEC ED TEACHER	Certificated	T02	05	T	A	1.00	43,611	1.00	43,759
EDN100/AA	7/30/2013	71657	SECONDARY TEACHER	Certificated	T03	05	P	A	1.00	42,204	1.00	47,259
EDN150/FA	7/30/2013	76332	SPEC ED TEACHER	Certificated	T02	05	P	A	1.00	52,797	1.00	43,759
EDN100/AA	7/30/2013	601002	SECONDARY TEACHER	Certificated	T02	05	T	A			1.00	33,169
EDN100/DB	7/30/2013	79614	ELEM TEACHER	Certificated	T02	05	T	N			1.00	43,759
EDN100/AA	7/30/2013	600897	ELEM TEACHER	Certificated	T03	05	T	A			1.00	48,678
EDN150/FA	7/30/2013	73796	SPEC ED TCHR/PRE-SCHOOL	Certificated	T02	05	P	A	1.00	48,585	1.00	33,169
EDN150/FA	7/30/2013	75662	SPEC ED TEACHER	Certificated	T03	05	T	A	1.00	44,920	1.00	35,822
EDN100/AA	7/30/2013	62573	SECONDARY TEACHER	Certificated	T02	05	P	A	1.00	73,038	1.00	43,759
EDN100/AA	7/30/2013	602647	ELEM TEACHER	Certificated	T02	05	T	A			1.00	43,759
EDN100/AA	7/30/2013	600892	ELEM TEACHER	Certificated	T02	05	T	A			1.00	43,759
EDN150/FA	7/30/2013	68526	SPEC ED TEACHER	Certificated	T02	05	P	A	1.00	51,049	1.00	43,759
EDN100/AA	7/30/2013	71150	ELEM TEACHER	Certificated	T02	05	P	A	1.00	46,117	1.00	43,759
EDN100/AA	7/30/2013	73157	COUNSELOR	Certificated	T02	05	P	A	1.00	63,058	1.00	43,759
EDN100/AA	7/30/2013	73899	SECONDARY TEACHER	Certificated	T02	05	P	A	1.00	53,568	1.00	45,072
EDN100/AA	7/30/2013	71128	ELEM TEACHER	Certificated	T02	05	P	A	1.00	39,671	1.00	33,169
EDN150/FA	7/30/2013	67812	SPEC ED TEACHER	Certificated	T02	05	P	A	1.00	43,611	1.00	33,169
EDN100/AA	7/30/2013	63871	ELEM TEACHER	Certificated	T02	05	P	A	1.00	67,863	1.00	43,759
EDN100/AA	7/30/2013	604064	SECONDARY TEACHER	Certificated	T02	05	T	A			1.00	43,759
EDN100/AA	7/30/2013	72360	ELEM TEACHER	Certificated	T02	05	T	A	1.00	44,774	1.00	45,072
EDN100/AA	7/30/2013	63460	ELEM TEACHER	Certificated	T02	05	P	A	1.00	44,736	1.00	43,759
EDN100/DB	7/30/2013	79908	SECONDARY TEACHER	Certificated	T02	05	T	N			1.00	33,169
EDN100/AA	7/30/2013	64784	SECONDARY TEACHER	Certificated	T02	05	P	A	1.00	42,204	1.00	43,759
EDN100/AA	7/30/2013	72037	SECONDARY TEACHER	Certificated	T03	05	P	A	1.00	51,798	1.00	48,678
EDN100/AA	7/30/2013	74312	SECONDARY TEACHER	Certificated	T03	05	P	A	1.00	63,058	1.00	48,678
EDN100/AA	7/30/2013	71557	ELEM TEACHER	Certificated	T03	05	T	A	1.00	45,579	1.00	47,259
EDN100/AA	7/30/2013	66722	SECONDARY TEACHER	Certificated	T02	05	P	A	1.00	61,168	1.00	45,072
EDN150/SA	7/30/2013	801329	EDUCATIONAL INTERPRETER II	N	SR14	03	P	A	1.00	26,733	1.00	32,424
EDN100/AA	7/30/2013	67997	ELEM TEACHER	Certificated	T02	05	P	A	1.00	61,070	1.00	33,169
EDN100/AA	7/30/2013	600657	ELEM TEACHER	Certificated	T03	05	T	A			1.00	47,259
EDN100/AA	7/30/2013	65894	SECONDARY TEACHER	Certificated	T03	05	P	A	1.00	51,798	1.00	47,259
EDN100/AA	7/30/2013	71165	SECONDARY TEACHER	Certificated	T02	05	T	A	1.00	45,579	1.00	43,759
EDN100/AA	7/30/2013	61548	ELEM TEACHER	Certificated	T03	05	P	A	1.00	46,948	1.00	47,259
EDN150/FA	7/30/2013	72257	SPEC ED TEACHER	Certificated	T02	05	P	A	1.00	55,167	1.00	33,169
EDN100/AA	7/30/2013	66217	SECONDARY TEACHER	Certificated	T02	05	P	A	1.00	49,806	1.00	45,072
EDN150/FA	7/30/2013	74070	SPEC ED TEACHER	Certificated	T02	05	P	A			1.00	45,072
EDN100/AA	7/30/2013	67263	SECONDARY TEACHER	Certificated	T02	05	P	A	1.00	42,204	1.00	43,759
EDN100/AA	7/30/2013	64360	ELEM TEACHER	Certificated	T03	05	P	A	1.00	45,579	1.00	47,259
EDN100/AA	7/30/2013	62028	SECONDARY TEACHER	Certificated	T03	05	P	A	1.00	77,421	1.00	47,259
EDN100/AA	7/30/2013	68788	SECONDARY TEACHER	Certificated	T03	05	P	A	1.00	52,302	1.00	48,678
EDN100/AA	7/30/2013	67344	ELEM TEACHER	Certificated	T02	05	T	A	1.00	52,302	1.00	43,759

<u>Prog ID/Org</u>	<u>New Hire Effective Date</u>	<u>Position Number</u>	<u>Position Title</u>	<u>Exempt (Y/N)</u>	<u>SR Level</u>	<u>BU Code</u>	<u>T/P</u>	<u>MOF</u>	<u>Budgeted FTE</u>	<u>Budgeted Salary</u>	<u>Actual FTE</u>	<u>Actual Salary</u>
EDN100/AA	7/30/2013	601010	ELEM TEACHER	Certificated	T02	05	T	A			1.00	43,759
EDN150/FA	7/30/2013	603517	GEN EDUC/ARTICLE VI TCHR	Certificated	T02	05	T	A			1.00	43,759
EDN100/AA	7/30/2013	65526	ELEM TEACHER	Certificated	T02	05	T	A	1.00	47,969	1.00	43,759
EDN150/FA	7/30/2013	60796	SPEC ED TEACHER	Certificated	T02	05	P	A	1.00	42,840	1.00	43,759
EDN100/AA	7/30/2013	62695	ELEM TEACHER	Certificated	T02	05	P	A	1.00	46,846	1.00	43,759
EDN100/AA	7/30/2013	68258	ELEM TEACHER	Certificated	T02	05	T	A	1.00	42,204	1.00	43,759
EDN150/FA	7/30/2013	600097	SPEC ED TEACHER	Certificated	T03	05	T	A	1.00	46,132	1.00	48,678
EDN100/AA	7/30/2013	603049	SECONDARY TEACHER	Certificated	T02	05	T	A			1.00	43,759
EDN100/AA	7/30/2013	601721	ELEM TEACHER	Certificated	T02	05	T	A	0.50	22,789	1.00	43,759
EDN100/AA	7/30/2013	66560	ELEM TEACHER	Certificated	T02	05	P	A	1.00	42,204	1.00	43,759
EDN100/AA	7/30/2013	600482	SECONDARY TEACHER	Certificated	T02	05	T	A			1.00	43,759
EDN150/FA	7/30/2013	67853	SPEC ED TEACHER	Certificated	T03	05	P	A	1.00	55,215	1.00	47,259
EDN150/FA	7/30/2013	68485	SPEC ED TEACHER	Certificated	T03	05	P	A	1.00	34,380	1.00	47,259
EDN100/AA	7/30/2013	604166	ELEM TEACHER	Certificated	T02	05	T	A			1.00	43,759
EDN150/FA	7/30/2013	600596	GEN EDUC/ARTICLE VI TCHR	Certificated	T02	05	T	A			1.00	43,759
EDN100/AA	7/30/2013	603391	SECONDARY TEACHER	Certificated	T03	05	T	A			1.00	47,259
EDN150/FA	7/30/2013	74528	GEN EDUC/ARTICLE VI TCHR	Certificated	T02	05	P	A	1.00	43,507	1.00	43,759
EDN100/AA	7/30/2013	603641	ELEM TEACHER	Certificated	T02	05	T	A			1.00	43,759
EDN150/FA	7/30/2013	62826	GEN EDUC/ARTICLE VI TCHR	Certificated	T02	05	T	A	1.00	48,469	1.00	33,169
EDN100/AA	7/30/2013	600352	ELEM TEACHER	Certificated	T02	05	T	A	1.00	42,204	1.00	43,759
EDN100/AA	7/30/2013	71090	ELEM TEACHER	Certificated	T02	05	P	A	1.00	53,870	1.00	43,759
EDN150/FA	7/30/2013	65627	SPEC ED TEACHER	Certificated	T02	05	P	A	1.00	46,268	1.00	43,759
EDN150/FA	7/30/2013	602255	SPEC ED TEACHER	Certificated	T02	05	T	A			1.00	43,759
EDN100/AA	7/30/2013	601940	ELEM TEACHER	Certificated	T02	05	T	A	1.00	42,204	1.00	43,759
EDN100/AA	7/30/2013	600576	ELEM TEACHER	Certificated	T02	05	T	A			1.00	43,759
EDN150/FA	7/30/2013	604004	SPEC ED TEACHER	Certificated	T02	05	T	A			1.00	43,759
EDN150/FA	7/30/2013	603241	GEN EDUC/ARTICLE VI TCHR	Certificated	T02	05	T	A			1.00	43,759
EDN100/AA	7/30/2013	65161	ELEM TEACHER	Certificated	T02	05	P	A	1.00	59,388	1.00	45,072
EDN100/AA	7/30/2013	66566	ELEM TEACHER	Certificated	T02	05	P	A	1.00	70,111	1.00	43,759
EDN100/AA	7/30/2013	61942	SECONDARY TEACHER	Certificated	T02	05	P	A	1.00	66,841	1.00	33,169
EDN100/AA	7/30/2013	64231	SECONDARY TEACHER	Certificated	T03	05	P	A	1.00	51,837	1.00	47,259
EDN100/AA	7/30/2013	72106	SECONDARY TEACHER	Certificated	T02	05	P	A	1.00	51,271	1.00	43,759
EDN100/AA	7/30/2013	65702	ELEM TEACHER	Certificated	T02	05	P	A	1.00	60,632	1.00	43,759
EDN100/AA	7/30/2013	604063	ELEM TEACHER	Certificated	T02	05	T	A			1.00	33,169
EDN100/DB	7/30/2013	604744	ELEM TEACHER	Certificated	T02	05	T	N			1.00	43,759
EDN150/FA	7/30/2013	68549	SPEC ED TEACHER	Certificated	T02	05	P	A			1.00	43,759
EDN100/AA	7/30/2013	74763	GEN EDUC/ARTICLE VI TCHR	Certificated	T02	05	T	A	1.00	45,579	1.00	43,759
EDN100/AA	7/30/2013	65491	ELEM TEACHER	Certificated	T03	05	P	A	1.00	69,160	1.00	47,259
EDN100/AA	7/30/2013	601009	ELEM TEACHER	Certificated	T02	05	T	A			1.00	43,759
EDN100/BV	7/30/2013	74893	ELEM TEACHER	Certificated	T03	05	T	A	1.00	51,732	1.00	47,259
EDN150/FA	7/30/2013	600212	SPEC ED TEACHER	Certificated	T02	05	T	A	1.00	40,381	1.00	43,759
EDN100/AA	7/30/2013	600573	SECONDARY TEACHER	Certificated	T02	05	T	A			0.50	21,879
EDN100/AA	7/30/2013	60735	SECONDARY TEACHER	Certificated	T03	05	P	A	1.00	48,356	1.00	47,259
EDN100/AA	7/30/2013	71627	ELEM TEACHER	Certificated	T03	05	P	A	1.00	64,325	1.00	47,259
EDN100/AA	7/30/2013	72190	ELEM TEACHER	Certificated	T03	05	P	A	1.00	50,290	1.00	47,259
EDN150/FA	7/30/2013	65023	GEN EDUC/ARTICLE VI TCHR	Certificated	T03	05	P	A			1.00	47,259
EDN100/AA	7/30/2013	71092	ELEM TEACHER	Certificated	T02	05	T	A	1.00	68,845	1.00	43,759

Department of Education
New Hires

Table 16

<u>Prog ID/Org</u>	<u>New Hire Effective Date</u>	<u>Position Number</u>	<u>Position Title</u>	<u>Exempt (Y/N)</u>	<u>SR Level</u>	<u>BU Code</u>	<u>T/P</u>	<u>MOF</u>	<u>Budgeted FTE</u>	<u>Budgeted Salary</u>	<u>Actual FTE</u>	<u>Actual Salary</u>
EDN100/AA	7/30/2013	62492	ELEM TEACHER	Certificated	T02	05	P	A	1.00	57,657	1.00	43,759
EDN100/AA	7/30/2013	600410	SECONDARY TEACHER	Certificated	T03	05	T	A	1.00	49,378	1.00	47,259
EDN100/AA	7/30/2013	62518	ELEM TEACHER	Certificated	T02	05	P	A	1.00	42,204	1.00	43,759
EDN100/AA	7/30/2013	63613	ELEM TEACHER	Certificated	T02	05	P	A	1.00	42,204	1.00	43,759
EDN150/NB	7/30/2013	604079	DIST OFF TCHR	Certificated	T03	05	T	N			1.00	47,259
EDN100/AA	7/30/2013	73412	SECONDARY TEACHER	Certificated	T02	05	P	A	0.50	22,387	1.00	43,759
EDN100/AA	7/30/2013	62586	ELEM TEACHER	Certificated	T03	05	P	A	1.00	54,393	1.00	48,678
EDN100/AA	7/30/2013	60569	ELEM TEACHER	Certificated	T03	05	T	A	1.00	52,809	1.00	47,259
EDN100/AA	7/30/2013	66176	SECONDARY TEACHER	Certificated	T02	05	P	A	1.00	48,825	1.00	45,072
EDN150/FA	7/30/2013	67917	GEN EDUC/ARTICLE VI TCHR	Certificated	T03	05	P	A	1.00	58,387	1.00	48,678
EDN100/AA	7/30/2013	68463	SECONDARY TEACHER	Certificated	T03	05	P	A	1.00	48,356	1.00	47,259
EDN100/AA	7/30/2013	603236	SECONDARY TEACHER	Certificated	T02	05	T	A			0.50	22,536
EDN150/FA	7/30/2013	63778	GEN EDUC/ARTICLE VI TCHR	Certificated	T02	05	P	A	1.00	43,507	1.00	43,759
EDN150/FA	7/30/2013	600165	GEN EDUC/ARTICLE VI TCHR	Certificated	T02	05	T	A	1.00	43,507	1.00	45,072
EDN100/AA	7/30/2013	64591	SECONDARY TEACHER	Certificated	T02	05	P	A	1.00	39,671	1.00	43,759
EDN100/AA	7/30/2013	71009	COUNSELOR	Certificated	T03	05	P	A	1.00	48,356	1.00	47,259
EDN100/AA	7/30/2013	74485	SECONDARY TEACHER	Certificated	T02	05	T	A	1.00	42,204	1.00	43,759
EDN100/AA	7/30/2013	61670	SECONDARY TEACHER	Certificated	T02	05	P	A	1.00	53,323	1.00	43,759
EDN150/FA	7/30/2013	67805	SPEC ED TEACHER	Certificated	T03	05	P	A	1.00	60,283	1.00	48,678
EDN150/FA	7/30/2013	69734	SPEC ED TEACHER	Certificated	T03	05	P	A			1.00	48,678
EDN100/AA	7/30/2013	67736	COUNSELOR	Certificated	T02	05	P	A	1.00	48,356	1.00	43,759
EDN150/FA	7/30/2013	75923	GEN EDUC/ARTICLE VI TCHR	Certificated	T02	05	P	A	1.00	48,003	1.00	43,759
EDN100/AA	7/30/2013	61049	SECONDARY TEACHER	Certificated	T02	05	P	A	1.00	59,388	1.00	33,169
EDN100/AA	7/30/2013	72326	SECONDARY TEACHER	Certificated	T02	05	P	A	1.00	42,204	1.00	43,759
EDN100/AA	7/30/2013	64876	ELEM TEACHER	Certificated	T03	05	P	A	1.00	42,204	1.00	48,678
EDN150/FA	7/30/2013	61304	SPEC ED TEACHER	Certificated	T02	05	P	A	1.00	53,345	1.00	33,169
EDN100/AA	7/30/2013	72026	SECONDARY TEACHER	Certificated	T02	05	P	A	1.00	45,579	1.00	43,759
EDN100/AA	7/30/2013	63109	SECONDARY TEACHER	Certificated	T02	05	P	A	1.00	57,657	1.00	33,169
EDN100/AA	7/30/2013	62771	SECONDARY TEACHER	Certificated	T02	05	P	A	1.00	57,706	1.00	43,759
EDN100/AA	7/30/2013	600651	SECONDARY TEACHER	Certificated	T02	05	T	A			1.00	33,169
EDN100/AA	7/30/2013	600661	ELEM TEACHER	Certificated	T02	05	T	A			1.00	45,072
EDN100/AA	7/30/2013	67198	SECONDARY TEACHER	Certificated	T02	05	P	A	1.00	59,436	1.00	45,072
EDN100/AA	7/30/2013	66401	SECONDARY TEACHER	Certificated	T02	05	P	A	1.00	54,425	1.00	43,759
EDN150/FA	7/30/2013	74023	SPEC ED TEACHER	Certificated	T02	05	P	A	1.00	46,268	1.00	43,759
EDN100/AA	7/30/2013	71135	ELEM TEACHER	Certificated	T02	05	P	A	1.00	55,979	1.00	45,072
EDN100/AA	7/30/2013	600558	ELEM TEACHER	Certificated	T03	05	T	A			1.00	47,259
EDN100/AA	7/30/2013	61008	SECONDARY TEACHER	Certificated	T02	05	P	A	1.00	59,388	1.00	43,759
EDN100/AA	7/30/2013	69728	ELEM TEACHER	Certificated	T03	05	P	A	1.00	58,923	1.00	48,678
EDN100/AA	7/30/2013	65751	ELEM TEACHER	Certificated	T02	05	P	A	1.00	77,421	1.00	43,759
EDN100/AA	7/30/2013	601217	ELEM TEACHER	Certificated	T02	05	T	A			1.00	43,759
EDN100/AA	7/30/2013	72636	ELEM TEACHER	Certificated	T03	05	P	A	1.00	54,892	1.00	48,678
EDN150/FA	7/30/2013	69436	SPEC ED TEACHER	Certificated	T02	05	P	A	1.00	48,118	1.00	43,759
EDN150/SA	7/30/2013	46665	SPEECH PATHOLOGIST IV	Y	SR22	13	P	A	1.00	62,996	1.00	47,400
EDN100/AA	7/30/2013	62118	ELEM TEACHER	Certificated	T03	05	P	A	1.00	45,579	1.00	47,259
EDN100/AA	7/30/2013	602286	ELEM TEACHER	Certificated	T03	05	T	A			1.00	47,259
EDN100/AA	7/30/2013	600673	ELEM TEACHER	Certificated	T02	05	T	A			1.00	45,072
EDN150/FA	7/30/2013	602311	SPEC ED TEACHER	Certificated	T02	05	T	A	1.00	40,381	1.00	45,072

<u>Prog ID/Org</u>	<u>New Hire Effective Date</u>	<u>Position Number</u>	<u>Position Title</u>	<u>Exempt (Y/N)</u>	<u>SR Level</u>	<u>BU Code</u>	<u>T/P</u>	<u>MOF</u>	<u>Budgeted FTE</u>	<u>Budgeted Salary</u>	<u>Actual FTE</u>	<u>Actual Salary</u>
EDN150/FA	7/30/2013	66224	SPEC ED TEACHER	Certificated	T02	05	P	A	1.00	41,593	1.00	45,072
EDN150/FA	7/30/2013	602976	SPEC ED TCHR/PRE-SCHOOL	Certificated	T03	05	T	A			1.00	48,678
EDN150/FA	7/30/2013	600587	SPEC ED TEACHER	Certificated	T03	05	T	A			1.00	48,678
EDN100/AA	7/30/2013	66223	SECONDARY TEACHER	Certificated	T02	05	P	A	1.00	42,204	1.00	33,169
EDN150/FA	7/30/2013	69582	SPEC ED TEACHER	Certificated	T03	05	P	A	1.00	30,609	1.00	48,678
EDN100/AA	7/30/2013	65128	ELEM TEACHER	Certificated	T03	05	P	A	1.00	56,058	1.00	47,259
EDN100/AA	7/30/2013	65682	ELEM TEACHER	Certificated	T02	05	P	A	1.00	52,302	1.00	43,759
EDN100/AA	7/30/2013	601437	SECONDARY TEACHER	Certificated	T02	05	T	A	1.00	31,990	1.00	43,759
EDN100/AA	7/30/2013	62488	SECONDARY TEACHER	Certificated	T03	05	P	A	1.00	77,421	1.00	47,259
EDN150/FA	7/30/2013	68681	SPEC ED TEACHER	Certificated	T02	05	T	A	1.00	40,381	1.00	33,169
EDN150/FA	7/30/2013	67197	SPEC ED TEACHER	Certificated	T03	05	P	A	1.00	46,268	1.00	48,678
EDN100/AA	7/30/2013	67153	SECONDARY TEACHER	Certificated	T03	05	P	A	1.00	48,356	1.00	47,259
EDN150/FA	7/30/2013	74074	SPEC ED TEACHER	Certificated	T03	05	P	A			1.00	48,678
EDN150/FA	7/30/2013	73724	SPEC ED TEACHER	Certificated	T03	05	P	A	1.00	40,381	1.00	48,678
EDN150/SA	7/30/2013	56285	SPEECH PATHOLOGIST II	Y	SR18	13	P	A	1.00	52,887	1.00	40,548
EDN150/FA	7/30/2013	600586	SPEC ED TEACHER	Certificated	T03	05	T	A			1.00	48,678
EDN100/AA	7/30/2013	600545	SECONDARY TEACHER	Certificated	T03	05	T	A			1.00	48,678
EDN100/AA	7/30/2013	67453	ELEM TEACHER	Certificated	T03	05	T	A	1.00	45,579	1.00	47,259
EDN150/SA	7/30/2013	27262	SPEECH PATHOLOGIST IV	Y	SR22	13	P	A	1.00	60,973	1.00	47,400
EDN150/FA	7/30/2013	75447	GEN EDUC/ARTICLE VI TCHR	Certificated	T01	05	T	A	1.00	46,157	1.00	30,534
EDN100/AA	7/30/2013	66754	ELEM TEACHER	Certificated	T03	05	P	A	1.00	59,388	1.00	47,259
EDN150/FA	7/30/2013	603377	SPEC ED TEACHER	Certificated	T02	05	T	A			1.00	33,169
EDN150/FA	7/30/2013	601947	GEN EDUC/ARTICLE VI TCHR	Certificated	T02	05	T	A	1.00	37,867	1.00	43,759
EDN150/FA	7/30/2013	601667	SPEC ED TEACHER	Certificated	T02	05	T	A	1.00	43,611	1.00	45,072
EDN100/AA	7/30/2013	68286	ELEM TEACHER	Certificated	T02	05	T	A	1.00	50,091	1.00	43,759
EDN100/AA	7/30/2013	75912	ELEM TEACHER	Certificated	T03	05	T	A	1.00	47,403	1.00	48,678
EDN150/FA	7/30/2013	74872	GEN EDUC/ARTICLE VI TCHR	Certificated	T02	05	P	A	1.00	40,285	1.00	43,759
EDN100/AA	7/30/2013	65120	ELEM TEACHER	Certificated	T02	05	P	A	1.00	51,301	1.00	45,072
EDN150/FA	7/30/2013	76028	SPEC ED TEACHER	Certificated	T03	05	T	A	1.00	37,958	1.00	48,678
EDN100/AA	7/30/2013	63029	SECONDARY TEACHER	Certificated	T02	05	P	A	1.00	61,168	1.00	45,072
EDN100/AA	7/30/2013	60227	COUNSELOR	Certificated	T02	05	P	A	1.00	59,388	1.00	43,759
EDN150/FA	7/30/2013	64290	SPEC ED TEACHER	Certificated	T02	05	P	A	1.00	43,611	1.00	43,759
EDN100/AA	7/30/2013	72666	SECONDARY TEACHER	Certificated	T03	05	P	A	1.00	48,356	1.00	47,259
EDN150/FA	7/30/2013	600534	SPEC ED TEACHER	Certificated	T03	05	T	A	1.00	44,920	1.00	47,259
EDN150/FA	7/30/2013	76018	SPEC ED TEACHER	Certificated	T03	05	P	A	1.00	52,044	1.00	48,678
EDN150/FA	7/30/2013	68051	SPEC ED TEACHER	Certificated	T02	05	T	A	1.00	56,823	1.00	33,169
EDN100/AA	7/30/2013	68079	ELEM TEACHER	Certificated	T01	05	P	A	1.00	44,774	1.00	30,534
EDN100/AA	7/30/2013	60306	ELEM TEACHER	Certificated	T02	05	P	A	1.00	45,796	1.00	43,759
EDN100/AA	7/30/2013	603872	ELEM TEACHER	Certificated	T02	05	T	A			1.00	43,759
EDN150/FA	7/30/2013	60618	SPEC ED TEACHER	Certificated	T02	05	P	A	1.00	41,593	1.00	43,759
EDN150/FA	7/30/2013	67960	SPEC ED TEACHER	Certificated	T02	05	P	A	1.00	50,043	1.00	43,759
EDN100/AA	7/30/2013	61725	SECONDARY TEACHER	Certificated	T02	05	P	A	1.00	48,356	1.00	43,759
EDN150/FA	7/30/2013	60285	SPEC ED TEACHER	Certificated	T02	05	P	A	1.00	45,356	1.00	33,169
EDN150/FA	7/30/2013	73322	SPEC ED TEACHER	Certificated	T02	05	P	A	1.00	43,611	1.00	33,169
EDN100/AA	7/30/2013	66632	SECONDARY TEACHER	Certificated	T02	05	P	A	1.00	39,671	1.00	33,169
EDN150/NB	7/30/2013	603476	DIST OFF TCHR	Certificated	T02	05	T	N			1.00	43,759
EDN100/AA	7/30/2013	65862	ELEM TEACHER	Certificated	T03	05	P	A	1.00	42,204	1.00	47,259

<u>Prog ID/Org</u>	<u>New Hire Effective Date</u>	<u>Position Number</u>	<u>Position Title</u>	<u>Exempt (Y/N)</u>	<u>SR Level</u>	<u>BU Code</u>	<u>T/P</u>	<u>MOF</u>	<u>Budgeted FTE</u>	<u>Budgeted Salary</u>	<u>Actual FTE</u>	<u>Actual Salary</u>
EDN100/AA	7/30/2013	64380	ELEM TEACHER	Certificated	T02	05	P	A	1.00	53,870	1.00	33,169
EDN150/FA	7/30/2013	72393	SPEC ED TEACHER	Certificated	T02	05	P	A	1.00	48,118	1.00	33,169
EDN100/AA	7/30/2013	603395	SECONDARY TEACHER	Certificated	T02	05	T	A			1.00	33,169
EDN150/FA	7/30/2013	61732	SPEC ED TEACHER	Certificated	T02	05	P	A	1.00	46,268	1.00	33,169
EDN100/AA	7/30/2013	63777	SECONDARY TEACHER	Certificated	T02	05	P	A	1.00	39,671	1.00	33,169
EDN100/AA	7/30/2013	72557	SECONDARY TEACHER	Certificated	T02	05	P	A	1.00	57,657	1.00	33,169
EDN100/AA	7/30/2013	603388	SECONDARY TEACHER	Certificated	T02	05	T	A			1.00	33,169
EDN150/FA	7/30/2013	74421	SPEC ED TEACHER	Certificated	T02	05	T	A	1.00	40,381	1.00	33,169
EDN100/AA	7/30/2013	68811	SECONDARY TEACHER	Certificated	T02	05	P	A	1.00	45,579	1.00	33,169
EDN100/AA	7/30/2013	62651	SECONDARY TEACHER	Certificated	T02	05	P	A	1.00	45,579	1.00	33,169
EDN100/AA	7/30/2013	65275	SECONDARY TEACHER	Certificated	T02	05	P	A	1.00	67,863	1.00	33,169
EDN100/AA	7/30/2013	63346	ELEM TEACHER	Certificated	T02	05	P	A	1.00	61,168	1.00	33,169
EDN150/FA	7/30/2013	67449	GEN EDUC/ARTICLE VI TCHR	Certificated	T02	05	P	A	1.00	46,157	1.00	33,169
EDN150/FA	7/30/2013	62048	SPEC ED TEACHER	Certificated	T02	05	T	A			1.00	33,169
EDN100/AA	7/30/2013	603103	ELEM TEACHER	Certificated	T02	05	T	A			1.00	33,169
EDN150/FA	7/30/2013	76061	SPEC ED TEACHER	Certificated	T02	05	P	A	1.00	49,086	1.00	33,169
EDN100/AA	7/30/2013	65092	ELEM TEACHER	Certificated	T02	05	P	A	1.00	45,579	1.00	33,169
EDN100/AA	7/30/2013	68000	SECONDARY TEACHER	Certificated	T02	05	P	A	1.00	62,450	1.00	33,169
EDN100/AA	7/30/2013	68630	SECONDARY TEACHER	Certificated	T02	05	P	A	1.00	39,671	1.00	33,169
EDN100/AA	7/30/2013	603111	SECONDARY TEACHER	Certificated	T02	05	T	A			1.00	33,169
EDN100/AA	7/30/2013	63773	SECONDARY TEACHER	Certificated	T02	05	P	A	1.00	42,204	1.00	43,759
EDN150/FA	7/30/2013	75839	SPEC ED TEACHER	Certificated	T02	05	T	A	1.00	48,118	1.00	43,759
EDN150/FA	7/30/2013	603637	SPEC ED TEACHER	Certificated	T02	05	T	A			1.00	33,169
EDN150/FA	7/30/2013	604078	SPEC ED TEACHER	Certificated	T03	05	T	A			1.00	48,678
EDN100/AA	7/30/2013	603762	ELEM TEACHER	Certificated	T02	05	T	A			1.00	33,169
EDN150/FA	7/30/2013	63200	SPEC ED TEACHER	Certificated	T02	05	P	A	1.00	30,609	1.00	33,169
EDN150/FA	7/30/2013	67200	SPEC ED TEACHER	Certificated	T02	05	P	A	1.00	50,043	1.00	43,759
EDN100/AA	7/30/2013	601220	SECONDARY TEACHER	Certificated	T02	05	T	A			1.00	33,169
EDN150/FA	7/30/2013	67179	SPEC ED TEACHER	Certificated	T02	05	P	A	1.00	43,611	1.00	43,759
EDN150/FA	7/30/2013	64930	SPEC ED TEACHER	Certificated	T02	05	P	A	1.00	43,611	1.00	33,169
EDN150/NB	7/30/2013	604297	DIST OFF TCHR	Certificated	T02	05	T	N			1.00	45,072
EDN100/AA	7/30/2013	600491	SECONDARY TEACHER	Certificated	T03	05	T	A			1.00	48,678
EDN150/FA	7/30/2013	71325	SPEC ED TEACHER	Certificated	T02	05	P	A	1.00	43,611	1.00	43,759
EDN100/AA	7/30/2013	68169	SECONDARY TEACHER	Certificated	T02	05	T	A	1.00	46,601	1.00	33,169
EDN100/AA	7/30/2013	64528	SECONDARY TEACHER	Certificated	T02	05	P	A	1.00	42,204	1.00	43,759
EDN150/FA	7/30/2013	72732	SPEC ED TEACHER	Certificated	T02	05	P	A	1.00	48,118	1.00	43,759
EDN150/FA	7/30/2013	73313	SPEC ED TEACHER	Certificated	T02	05	P	A	1.00	50,043	1.00	43,759
EDN100/AA	7/30/2013	65788	SECONDARY TEACHER	Certificated	T02	05	P	A	1.00	45,579	1.00	43,759
EDN100/AA	7/30/2013	67678	SECONDARY TEACHER	Certificated	T02	05	T	A	1.00	50,778	1.00	43,759
EDN100/AA	7/30/2013	67435	ELEM TEACHER	Certificated	T02	05	P	A	1.00	45,579	1.00	45,072
EDN150/FA	7/30/2013	74419	SPEC ED TEACHER	Certificated	T02	05	P	A	1.00	49,086	1.00	33,169
EDN100/AA	7/30/2013	602848	SECONDARY TEACHER	Certificated	T02	05	T	A			1.00	33,169
EDN150/FA	7/30/2013	73937	SPEC ED TEACHER	Certificated	T02	05	P	A	1.00	46,568	1.00	33,169
EDN100/AA	7/30/2013	64964	SECONDARY TEACHER	Certificated	T02	05	P	A	1.00	49,806	1.00	33,169
EDN150/FA	7/30/2013	69361	SPEC ED TEACHER	Certificated	T02	05	P	A	1.00	74,078	1.00	33,169
EDN100/AA	7/30/2013	604012	ELEM TEACHER	Certificated	T03	05	T	A			1.00	48,678
EDN100/AA	7/30/2013	601212	SPEC ED TEACHER	Certificated	T02	05	T	A			1.00	43,759

<u>Prog ID/Org</u>	<u>New Hire Effective Date</u>	<u>Position Number</u>	<u>Position Title</u>	<u>Exempt (Y/N)</u>	<u>SR Level</u>	<u>BU Code</u>	<u>T/P</u>	<u>MOF</u>	<u>Budgeted FTE</u>	<u>Budgeted Salary</u>	<u>Actual FTE</u>	<u>Actual Salary</u>
EDN100/AA	7/30/2013	61651	ELEM TEACHER	Certificated	T02	05	T	A	1.00	39,671	1.00	45,072
EDN150/FA	7/30/2013	74680	SPEC ED TEACHER	Certificated	T03	05	T	A	1.00	48,118	1.00	47,259
EDN150/FA	7/30/2013	71912	SPEC ED TEACHER	Certificated	T02	05	P	A	1.00	40,381	1.00	43,759
EDN100/AA	7/30/2013	602096	SECONDARY TEACHER	Certificated	T03	05	T	A	1.00	44,774	1.00	48,678
EDN100/AA	7/30/2013	62552	SECONDARY TEACHER	Certificated	T02	05	P	A	1.00	46,117	1.00	33,169
EDN150/FA	7/30/2013	63003	SPEC ED TEACHER	Certificated	T02	05	P	A	1.00	43,611	1.00	43,759
EDN100/DB	7/30/2013	602544	SECONDARY TEACHER	Certificated	T02	05	T	N			1.00	43,759
EDN150/FA	7/30/2013	604313	SPEC ED TEACHER	Certificated	T02	05	T	A			1.00	43,759
EDN100/AA	7/30/2013	73197	SECONDARY TEACHER	Certificated	T02	05	T	A	1.00	39,670	1.00	33,169
EDN100/AA	7/30/2013	66509	ELEM TEACHER	Certificated	T02	05	P	A	1.00	68,845	1.00	43,759
EDN100/AA	7/30/2013	61918	SECONDARY TEACHER	Certificated	T02	05	P	A	1.00	44,774	1.00	43,759
EDN100/AA	7/30/2013	62852	SECONDARY TEACHER	Certificated	T02	05	P	A	1.00	39,671	1.00	33,169
EDN100/AA	7/30/2013	68342	ELEM TEACHER	Certificated	T02	05	P	A	1.00	61,168	1.00	43,759
EDN150/SA	7/30/2013	30424	SPEECH PATHOLOGIST II	Y	SR18	13	P	A	1.00	51,891	1.00	21,049
EDN100/AA	7/30/2013	68236	SECONDARY TEACHER	Certificated	T03	05	P	A	1.00	50,290	1.00	48,678
EDN100/AA	7/30/2013	600771	SECONDARY TEACHER	Certificated	T02	05	T	A	1.00	50,290	1.00	43,759
EDN100/AA	7/30/2013	601642	ELEM TEACHER	Certificated	T02	05	T	A	1.00	48,356	1.00	33,169
EDN100/AA	7/30/2013	603342	SECONDARY TEACHER	Certificated	T02	05	T	A			1.00	33,169
EDN150/FA	7/30/2013	64468	SPEC ED TEACHER	Certificated	T02	05	P	A	1.00	46,268	1.00	33,169
EDN100/AA	7/30/2013	603759	ELEM TEACHER	Certificated	T02	05	T	A			1.00	33,169
EDN150/FA	7/30/2013	72127	SPEC ED TEACHER	Certificated	T02	05	P	A	1.00	41,593	1.00	33,169
EDN100/AA	7/30/2013	601480	ELEM TEACHER	Certificated	T02	05	T	A	1.00	45,579	1.00	33,169
EDN100/AA	7/30/2013	60714	SECONDARY TEACHER	Certificated	T02	05	T	A	1.00	42,204	1.00	43,759
EDN100/AA	7/30/2013	67511	SECONDARY TEACHER	Certificated	T02	05	P	A	1.00	44,774	1.00	33,169
EDN150/FA	7/30/2013	64845	SPEC ED TEACHER	Certificated	T02	05	P	A	1.00	43,611	1.00	33,169
EDN150/FA	7/30/2013	67998	SPEC ED TEACHER	Certificated	T02	05	P	A	1.00	37,958	1.00	33,169
EDN150/FA	7/30/2013	604338	SPEC ED TEACHER	Certificated	T02	05	T	A			1.00	43,759
EDN100/AA	7/30/2013	65524	ELEM TEACHER	Certificated	T02	05	P	A	1.00	46,948	1.00	33,169
EDN100/AA	7/30/2013	603960	SECONDARY TEACHER	Certificated	T03	05	T	A			1.00	48,678
EDN150/FA	7/30/2013	62367	SPEC ED TEACHER	Certificated	T02	05	P	A	1.00	47,479	1.00	33,169
EDN150/FA	7/30/2013	67861	SPEC ED TEACHER	Certificated	T03	05	P	A	1.00	58,527	1.00	48,678
EDN100/AA	7/30/2013	62199	SECONDARY TEACHER	Certificated	T03	05	P	A	1.00	56,509	1.00	48,678
EDN100/AA	7/30/2013	604058	ELEM TEACHER	Certificated	T03	05	T	A			1.00	35,822
EDN150/FA	7/30/2013	71148	SPEC ED TEACHER	Certificated	T02	05	P	A	1.00	41,593	1.00	33,169
EDN100/AA	7/30/2013	600500	SECONDARY TEACHER	Certificated	T02	05	T	A	1.00	45,579	1.00	33,169
EDN150/FA	7/30/2013	604328	SPEC ED TEACHER	Certificated	T03	05	T	A			1.00	48,678
EDN100/AA	7/30/2013	67489	SECONDARY TEACHER	Certificated	T02	05	P	A	1.00	77,421	1.00	33,169
EDN100/AA	7/30/2013	61930	SECONDARY TEACHER	Certificated	T02	05	P	A	1.00	39,671	1.00	33,169
EDN150/FA	7/30/2013	602934	SPEC ED TEACHER	Certificated	T02	05	T	A			1.00	33,169
EDN150/FA	7/30/2013	73736	SPEC ED TEACHER	Certificated	T02	05	P	A	1.00	40,381	1.00	33,169
EDN150/FA	7/30/2013	603192	GEN EDUC/ARTICLE VI TCHR	Certificated	T02	05	T	A			1.00	33,169
EDN100/AA	7/30/2013	64082	ELEM TEACHER	Certificated	T02	05	T	A	1.00	43,470	1.00	43,759
EDN100/AA	7/30/2013	603998	ELEM TEACHER	Certificated	T02	05	T	A			1.00	33,169
EDN150/FA	7/30/2013	600173	SPEC ED TEACHER	Certificated	T03	05	T	A	1.00	43,611	1.00	47,259
EDN100/AA	7/30/2013	67195	ELEM TEACHER	Certificated	T02	05	P	A	1.00	49,847	1.00	33,169
EDN100/DB	7/30/2013	79918	SECONDARY TEACHER	Certificated	T02	05	T	N			1.00	45,072
EDN100/AA	7/30/2013	68703	SECONDARY TEACHER	Certificated	T02	05	T	A	1.00	45,579	1.00	33,169

Department of Education
New Hires

Table 16

<u>Prog ID/Org</u>	<u>New Hire Effective Date</u>	<u>Position Number</u>	<u>Position Title</u>	<u>Exempt (Y/N)</u>	<u>SR Level</u>	<u>BU Code</u>	<u>T/P</u>	<u>MOF</u>	<u>Budgeted FTE</u>	<u>Budgeted Salary</u>	<u>Actual FTE</u>	<u>Actual Salary</u>
EDN150/FA	7/30/2013	75656	SPEC ED TEACHER	Certificated	T02	05	T	A	1.00	40,381	1.00	33,169
EDN150/FA	7/30/2013	603522	SPEC ED TEACHER	Certificated	T02	05	T	A			1.00	45,072
EDN100/AA	7/30/2013	63122	ELEM TEACHER	Certificated	T02	05	P	A	1.00	42,844	1.00	33,169
EDN100/AA	7/30/2013	72294	ELEM TEACHER	Certificated	T02	05	P	A	1.00	59,388	1.00	45,072
EDN150/FA	7/30/2013	601628	SPEC ED TEACHER	Certificated	T03	05	T	A	1.00	58,527	1.00	48,678
EDN100/AA	7/30/2013	60496	ELEM TEACHER	Certificated	T03	05	T	A	1.00	50,290	1.00	47,259
EDN100/AA	7/30/2013	65809	ELEM TEACHER	Certificated	T02	05	T	A	1.00	48,356	1.00	45,072
EDN100/AA	7/30/2013	600895	ELEM TEACHER	Certificated	T02	05	T	A			1.00	43,759
EDN150/FA	7/30/2013	61299	SPEC ED TEACHER	Certificated	T02	05	P	A	1.00	50,043	1.00	43,759
EDN100/AA	7/30/2013	64078	SECONDARY TEACHER	Certificated	T02	05	P	A	1.00	45,579	1.00	33,169
EDN150/FA	7/30/2013	63779	SPEC ED TEACHER	Certificated	T02	05	P	A	1.00	53,561	1.00	33,169
EDN100/AA	7/30/2013	65412	ELEM TEACHER	Certificated	T02	05	P	A	1.00	58,679	1.00	33,169
EDN100/AA	7/30/2013	603997	ELEM TEACHER	Certificated	T02	05	T	A			1.00	33,169
EDN100/AA	7/30/2013	604013	ELEM TEACHER	Certificated	T02	05	T	A			1.00	33,169
EDN150/FA	7/30/2013	74084	SPEC ED TEACHER	Certificated	T02	05	T	A	1.00	37,958	1.00	33,169
EDN100/AA	7/30/2013	68917	ELEM TEACHER	Certificated	T02	05	P	A	1.00	48,825	1.00	33,169
EDN150/FA	7/30/2013	63640	SPEC ED TEACHER	Certificated	T02	05	T	A	1.00	43,611	1.00	33,169
EDN100/AA	7/30/2013	71567	SECONDARY TEACHER	Certificated	T03	05	T	A	0.50	27,895	1.00	48,678
EDN100/AA	7/30/2013	62330	SECONDARY TEACHER	Certificated	T02	05	P	A	1.00	39,671	1.00	33,169
EDN150/FA	7/30/2013	72429	SPEC ED TEACHER	Certificated	T02	05	P	A	1.00	37,958	1.00	33,169
EDN100/AA	7/30/2013	64569	SECONDARY TEACHER	Certificated	T02	05	P	A	1.00	42,204	1.00	33,169
EDN150/FA	7/30/2013	72250	SPEC ED TEACHER	Certificated	T02	05	P	A	1.00	43,611	1.00	33,169
EDN100/AA	7/30/2013	67509	SECONDARY TEACHER	Certificated	T02	05	P	A	1.00	43,470	1.00	33,169
EDN100/AA	7/30/2013	63619	ELEM TEACHER	Certificated	T02	05	T	A	1.00	60,049	1.00	33,169
EDN100/AA	7/30/2013	65205	ELEM TEACHER	Certificated	T02	05	P	A	1.00	42,204	1.00	33,169
EDN100/AA	7/30/2013	69120	ELEM TEACHER	Certificated	T02	05	P	A	1.00	73,038	1.00	33,169
EDN100/BV	7/30/2013	74207	ELEM TEACHER	Certificated	T02	05	T	A	1.00	57,646	1.00	33,169
EDN150/FA	7/30/2013	75722	SPEC ED TEACHER	Certificated	T02	05	T	A	1.00	41,359	1.00	33,169
EDN100/AA	7/30/2013	63344	SECONDARY TEACHER	Certificated	T03	05	P	A	1.00	48,356	1.00	35,822
EDN100/AA	7/30/2013	67650	SECONDARY TEACHER	Certificated	T02	05	P	A	1.00	66,841	1.00	33,169
EDN100/AA	7/30/2013	64016	ELEM TEACHER	Certificated	T02	05	P	A	1.00	52,302	1.00	45,072
EDN100/BB	7/30/2013	64090	SECONDARY TEACHER	Certificated	T03	05	P	A	1.00	69,751	1.00	38,004
EDN100/AA	7/30/2013	71317	ELEM TEACHER	Certificated	T02	05	P	A	1.00	55,487	1.00	43,759
EDN150/FA	7/30/2013	73434	SPEC ED TEACHER	Certificated	T02	05	P	A	1.00	49,330	1.00	33,169
EDN150/FA	7/30/2013	67970	SPEC ED TEACHER	Certificated	T03	05	P	A	1.00	40,381	1.00	47,259
EDN150/FA	7/30/2013	60662	SPEC ED TEACHER	Certificated	T02	05	P	A	1.00	43,611	1.00	43,759
EDN150/FA	7/30/2013	75865	SPEC ED TEACHER	Certificated	T02	05	P	A	1.00	43,611	1.00	43,759
EDN150/FA	7/30/2013	62527	SPEC ED TEACHER	Certificated	T02	05	P	A	1.00	43,611	1.00	43,759
EDN150/FA	7/30/2013	72204	SPEC ED TEACHER	Certificated	T02	05	P	A	1.00	46,268	1.00	33,169
EDN100/AA	7/30/2013	68426	SECONDARY TEACHER	Certificated	T02	05	P	A	1.00	47,969	1.00	43,759
EDN100/AA	7/30/2013	71185	SECONDARY TEACHER	Certificated	T02	05	P	A	1.00	63,058	1.00	43,759
EDN150/FA	7/30/2013	61476	SPEC ED TEACHER	Certificated	T02	05	P	A	1.00	43,611	1.00	43,759
EDN100/AA	7/30/2013	63703	SECONDARY TEACHER	Certificated	T02	05	P	A	1.00	46,948	1.00	33,169
EDN100/AA	7/30/2013	68331	SECONDARY TEACHER	Certificated	T01	05	P	A	1.00	39,671	1.00	30,534
EDN100/AA	7/30/2013	600654	SECONDARY TEACHER	Certificated	T02	05	T	A			1.00	33,169
EDN100/AA	7/30/2013	65336	ELEM TEACHER	Certificated	T01	05	P	A	1.00	44,774	1.00	30,534
EDN100/AA	7/30/2013	600652	SECONDARY TEACHER	Certificated	T02	05	T	A			1.00	33,169

<u>Prog ID/Org</u>	<u>New Hire Effective Date</u>	<u>Position Number</u>	<u>Position Title</u>	<u>Exempt (Y/N)</u>	<u>SR Level</u>	<u>BU Code</u>	<u>T/P</u>	<u>MOF</u>	<u>Budgeted FTE</u>	<u>Budgeted Salary</u>	<u>Actual FTE</u>	<u>Actual Salary</u>
EDN150/FA	7/30/2013	67383	SPEC ED TEACHER	Certificated	T02	05	P	A	1.00	37,958	1.00	33,169
EDN150/FA	7/30/2013	62858	GEN EDUC/ARTICLE VI TCHR	Certificated	T02	05	P	A	1.00	44,813	1.00	43,759
EDN100/BV	7/30/2013	61880	ELEM TEACHER	Certificated	T02	05	T	A	1.00	30,148	1.00	33,169
EDN100/AA	7/30/2013	69633	SECONDARY TEACHER	Certificated	T02	05	P	A	1.00	57,657	1.00	33,169
EDN150/FA	7/31/2013	55130	EDUC ASST I	Y	SR08	03	P	A	0.75	18,338	0.75	16,043
EDN150/FA	7/31/2013	58882	EDUC ASST III	Y	SR12	03	T	A	0.75	19,796	0.75	18,773
EDN150/FA	7/31/2013	32243	EDUC ASST III	Y	SR12	03	P	A	1.00	24,450	1.00	25,030
EDN150/YG	7/31/2013	800848	EDUC ASST III	Y	SR12	03	P	A			1.00	25,030
EDN150/FA	7/31/2013	800923	EDUC ASST III	Y	SR12	03	T	A	0.75	18,338	0.75	18,773
EDN150/FA	7/31/2013	52625	EDUC ASST II	Y	SR10	03	P	A	0.50	12,226	0.50	11,565
EDN100/AA	7/31/2013	801402	EDUC ASST I	Y	SR08	03	T	A			1.00	21,390
EDN150/FA	7/31/2013	801337	EDUC ASST III	Y	SR12	03	T	A			1.00	25,030
EDN150/FA	7/31/2013	801477	EDUC ASST I	Y	SR08	03	P	A	1.00	27,479	1.00	13,327
EDN150/FA	7/31/2013	58037	EDUC ASST II	Y	SR10	03	P	A	1.00	26,395	1.00	23,130
EDN150/NB	7/31/2013	800360	EDUC ASST III	Y	SR12	03	T	N			1.00	25,030
EDN150/FA	7/31/2013	37503	EDUC ASST II	Y	SR10	03	P	A	1.00	27,479	1.00	23,130
EDN150/FA	7/31/2013	56052	EDUC ASST II	Y	SR10	03	P	A	0.75	19,056	0.75	17,348
EDN150/FA	7/31/2013	53006	EDUC ASST I	Y	SR08	03	P	A	1.00	24,450	0.75	16,043
EDN150/SA	7/31/2013	30461	COMMUNICATION AIDE	Y	SR12	03	P	A	1.00	24,107	1.00	15,595
EDN150/YG	7/31/2013	801858	EDUC ASST I	Y	SR08	03	T	A			1.00	21,390
EDN100/AA	7/31/2013	63953	SECONDARY TEACHER	Certificated	T02	05	P	A	1.00	70,911	1.00	33,169
EDN150/FA	7/31/2013	800062	EDUC ASST I	Y	SR08	03	T	A			1.00	21,390
EDN150/FA	7/31/2013	800492	EDUC ASST II	Y	SR10	03	P	A	1.00	24,450	1.00	23,130
EDN150/FA	7/31/2013	60293	GEN EDUC/ARTICLE VI TCHR	Certificated	T02	05	P	A	1.00	45,248	1.00	43,759
EDN100/AA	7/31/2013	62709	ELEM TEACHER	Certificated	T02	05	P	A	1.00	42,204	1.00	43,759
EDN150/NB	7/31/2013	800359	EDUC ASST I	Y	SR08	03	T	N			1.00	13,327
EDN150/FA	7/31/2013	76006	SPEC ED TEACHER	Certificated	T02	05	P	A	1.00	69,884	1.00	43,759
EDN150/YG	7/31/2013	801855	EDUC ASST I	Y	SR08	03	T	A			1.00	21,390
EDN150/FA	7/31/2013	52547	EDUC ASST I	Y	SR08	03	P	A	1.00	24,450	1.00	21,390
EDN150/FA	7/31/2013	52522	EDUC ASST I	Y	SR08	03	P	A	0.50	14,863	0.50	10,695
EDN150/FA	7/31/2013	801294	EDUC ASST II	Y	SR10	03	T	A	0.75	18,338	0.50	11,565
EDN150/FA	7/31/2013	57251	EDUC ASST III	Y	SR12	03	P	A	0.75	19,796	0.75	18,773
EDN150/FA	7/31/2013	61275	SPEC ED TEACHER	Certificated	T02	05	P	A	1.00	51,021	1.00	33,169
EDN150/YG	7/31/2013	801734	EDUC ASST III	Y	SR12	03	T	A			1.00	25,030
EDN150/YG	7/31/2013	802158	EDUC ASST II	Y	SR10	03	T	A			1.00	23,130
EDN150/FA	7/31/2013	74790	GEN EDUC/ARTICLE VI TCHR	Certificated	T02	05	T	A	1.00	55,035	1.00	43,759
EDN100/AA	7/31/2013	601576	ELEM TEACHER	Certificated	T03	05	T	A	1.00	66,841	1.00	48,678
EDN100/AA	7/31/2013	802922	EDUC ASST II	Y	SR10	03	T	A			1.00	23,130
EDN100/AA	7/31/2013	74367	COUNSELOR	Certificated	T03	05	P	A	1.00	54,393	1.00	47,259
EDN100/AA	7/31/2013	64807	SECONDARY TEACHER	Certificated	T02	05	P	A	1.00	49,622	1.00	33,169
EDN100/AA	7/31/2013	802433	EDUC ASST III	Y	SR12	03	T	A			0.75	18,773
EDN100/AA	7/31/2013	802940	EDUC ASST I	Y	SR08	03	T	A			1.00	13,327
EDN150/FA	7/31/2013	48794	EDUC ASST II	Y	SR10	03	T	A	1.00	24,450	1.00	23,130
EDN150/SA	7/31/2013	31336	SPEECH PATHOLOGIST IV	Y	SR22	13	P	A	1.00	51,891	1.00	24,613
EDN100/AA	7/31/2013	603589	ELEM TEACHER	Certificated	T03	05	T	A			1.00	47,259
EDN150/FA	7/31/2013	47139	EDUC ASST I	Y	SR08	03	P	A	0.75	19,796	0.75	16,043
EDN100/AA	7/31/2013	603607	ELEM TEACHER	Certificated	T03	05	T	A			1.00	47,259

Department of Education
New Hires

Table 16

<u>Prog ID/Org</u>	<u>New Hire Effective Date</u>	<u>Position Number</u>	<u>Position Title</u>	<u>Exempt (Y/N)</u>	<u>SR Level</u>	<u>BU Code</u>	<u>T/P</u>	<u>MOF</u>	<u>Budgeted FTE</u>	<u>Budgeted Salary</u>	<u>Actual FTE</u>	<u>Actual Salary</u>
EDN150/SA	7/31/2013	30465	COMMUNICATION AIDE	Y	SR12	03	P	A	1.00	27,093	1.00	25,030
EDN150/FA	7/31/2013	801458	EDUC ASST I	Y	SR08	03	T	A	1.00	24,450	1.00	13,327
EDN150/FA	7/31/2013	51912	EDUC ASST I	Y	SR08	03	P	A	1.00	24,450	1.00	13,327
EDN100/AA	8/1/2013	604435	ELEM TEACHER	Certificated	T02	05	T	A			1.00	43,759
EDN100/AA	8/1/2013	802176	OFFICE ASSISTANT II	N	SR06	03	T	A	1.00	25,101	1.00	23,688
EDN150/NB	8/1/2013	801132	EDUC ASST I	Y	SR08	03	T	N			1.00	13,327
EDN150/FA	8/1/2013	60802	GEN EDUC/ARTICLE VI TCHR	Certificated	T02	05	P	A	1.00	56,768	1.00	43,759
EDN150/YC	8/1/2013	58418	BEHAVIORAL HLTH SPCLT III	N	SR20	13	P	A	1.00	47,360	1.00	43,812
EDN150/FA	8/1/2013	803053	EDUC ASST I	Y	SR08	03	T	A			1.00	13,327
EDN100/AA	8/1/2013	602695	ELEM TEACHER	Certificated	T02	05	T	A			1.00	43,759
EDN100/AA	8/1/2013	18563	SCHOOL CUSTODIAN II	N	BC02	01	P	A	0.50	16,247	0.50	16,614
EDN300/KF	8/1/2013	601456	FISCAL SPECIALIST III	Certificated	E08	06	T	A			1.00	80,350
EDN100/AA	8/1/2013	802730	OFFICE ASSISTANT III	N	SR08	03	T	A			1.00	25,668
EDN100/AA	8/1/2013	33194	OFFICE ASSISTANT III	N	SR08	03	P	A	1.00	27,143	1.00	13,327
EDN150/FA	8/1/2013	56133	EDUC ASST II	Y	SR10	03	P	A	0.75	18,338	0.75	17,348
EDN150/FA	8/1/2013	69397	SPEC ED TEACHER	Certificated	T03	05	P	A	1.00	42,840	1.00	48,678
EDN150/FA	8/1/2013	802787	EDUC ASST III	Y	SR12	03	T	A			1.00	25,030
EDN100/AA	8/1/2013	603595	ELEM TEACHER	Certificated	T02	05	T	A			1.00	33,169
EDN100/AA	8/1/2013	29351	SCHOOL HEALTH AIDE	N	SR09	03	P	A	1.00	19,187	1.00	13,867
EDN100/AA	8/1/2013	604412	SPEC ED TEACHER	Certificated	T03	05	T	A			1.00	47,259
EDN100/AA	8/1/2013	604437	ELEM TEACHER	Certificated	T02	05	T	A			1.00	43,759
EDN100/AA	8/1/2013	602726	ELEM TEACHER	Certificated	T03	05	T	A			1.00	48,678
EDN100/AA	8/1/2013	58023	SCHOOL CUSTODIAN II	N	BC02	01	P	A	0.50	16,247	0.50	16,614
EDN150/YC	8/1/2013	59133	OFFICE ASSISTANT III	N	SR08	03	T	A	0.50	11,846	0.50	6,664
EDN100/AA	8/1/2013	74264	SECONDARY TEACHER	Certificated	T02	05	T	A	1.00	45,579	1.00	45,072
EDN100/AA	8/1/2013	802773	DP USER SUPPORT TECH II	N	SR15	03	T	A			1.00	17,528
EDN150/FB	8/1/2013	602857	SPEC ED TEACHER	Certificated	T02	05	P	A			1.00	50,760
EDN100/AA	8/1/2013	66589	SECONDARY TEACHER	Certificated	T02	05	P	A	1.00	48,356	1.00	33,169
EDN400/MD	8/2/2013	45866	CAFETERIA HELPER	N	BC02	01	T	N	0.50	16,614	0.50	16,614
EDN400/MD	8/2/2013	51654	CAFETERIA HELPER	N	BC02	01	T	N	0.50	16,614	0.50	16,614
EDN400/MD	8/2/2013	55500	CAFETERIA HELPER	N	BC02	01	T	N			0.50	16,614
EDN150/FA	8/2/2013	802756	EDUC ASST III	Y	SR12	03	T	A			0.75	18,773
EDN400/MD	8/2/2013	35309	CAFETERIA HELPER	N	BC02	01	T	B			0.50	16,614
EDN400/MD	8/2/2013	59647	CAFETERIA HELPER	N	BC02	01	T	B	0.50	16,614	0.50	8,629
EDN400/MD	8/2/2013	52794	CAFETERIA HELPER	N	BC02	01	T	B			0.50	16,614
EDN400/MD	8/2/2013	59064	CAFETERIA HELPER	N	BC02	01	T	B			0.50	16,614
EDN100/AA	8/2/2013	66397	SECONDARY TEACHER	Certificated	T02	05	P	A	1.00	59,388	0.50	21,879
EDN150/FA	8/2/2013	800085	EDUC ASST I	Y	SR08	03	T	A			1.00	13,327
EDN150/FA	8/2/2013	56715	EDUC ASST I	Y	SR08	03	T	A	1.00	24,450	1.00	21,390
EDN400/MD	8/2/2013	59667	CAFETERIA HELPER	N	BC02	01	T	N			0.50	16,614
EDN400/MD	8/2/2013	802416	CAFETERIA HELPER	N	BC02	01	T	N	0.50	16,614	0.50	8,629
EDN400/MD	8/2/2013	59907	CAFETERIA HELPER	N	BC02	01	T	B			0.50	16,614
EDN400/MD	8/2/2013	2075	CAFETERIA HELPER	N	BC02	01	T	B			0.50	8,629
EDN400/MD	8/2/2013	34238	CAFETERIA HELPER	N	BC02	01	T	N	0.50	16,614	0.50	16,614
EDN150/SA	8/2/2013	801321	EDUCATIONAL INTERPRETER I	N	SR12	03	P	A	1.00	24,765	1.00	30,036
EDN400/MD	8/2/2013	59063	CAFETERIA HELPER	N	BC02	01	T	B			0.50	16,614
EDN400/MD	8/2/2013	802865	CAFETERIA HELPER	N	BC02	01	T	N			0.50	16,614

<u>Prog ID/Org</u>	<u>New Hire Effective Date</u>	<u>Position Number</u>	<u>Position Title</u>	<u>Exempt (Y/N)</u>	<u>SR Level</u>	<u>BU Code</u>	<u>T/P</u>	<u>MOF</u>	<u>Budgeted FTE</u>	<u>Budgeted Salary</u>	<u>Actual FTE</u>	<u>Actual Salary</u>
EDN400/MD	8/2/2013	801958	CAFETERIA HELPER	N	BC02	01	T	N			0.50	16,614
EDN100/AA	8/2/2013	67367	SECONDARY TEACHER	Certificated	T02	05	P	A	1.00	66,897	1.00	43,759
EDN100/AA	8/2/2013	602050	SECONDARY TEACHER	Certificated	T02	05	T	A	1.00	48,356	1.00	43,759
EDN400/MD	8/2/2013	28011	CAFETERIA HELPER	N	BC02	01	T	B			0.50	16,614
EDN100/BX	8/4/2013	802977	SCHOOL DORMITORY ATTENDANT	N	HE03	10	P	A			1.00	17,539
EDN100/BX	8/4/2013	802976	SCHOOL DORMITORY ATTENDANT	N	HE03	10	P	A			1.00	17,539
EDN150/FA	8/5/2013	29763	EDUC ASST I	Y	SR08	03	P	A	1.00	32,138	1.00	13,327
EDN100/AA	8/5/2013	30597	SCHOOL SECURITY ATTENDANT	N	SR07	03	P	A	1.00	20,970	1.00	12,798
EDN150/FA	8/5/2013	57249	EDUC ASST I	Y	SR08	03	P	A	0.50	14,863	1.00	13,327
EDN150/FA	8/5/2013	800048	EDUC ASST III	Y	SR12	03	P	A	0.75	20,609	0.75	18,773
EDN100/AA	8/5/2013	68883	SECONDARY TEACHER	Certificated	T02	05	P	A	1.00	49,378	1.00	45,072
EDN150/NB	8/5/2013	802223	EDUC ASST I	Y	SR08	03	T	N			1.00	13,327
EDN100/AA	8/5/2013	71137	ELEM TEACHER	Certificated	T03	05	P	A	1.00	49,378	1.00	48,678
EDN150/FA	8/5/2013	75653	SPEC ED TEACHER	Certificated	T02	05	T	A	1.00	43,611	1.00	33,169
EDN100/AA	8/5/2013	604233	SECONDARY TEACHER	Certificated	T02	05	T	A			1.00	33,169
EDN150/FA	8/5/2013	47063	EDUC ASST I	Y	SR08	03	P	A	1.00	27,479	1.00	13,327
EDN150/YG	8/5/2013	802383	EDUC ASST I	Y	SR08	03	T	A			1.00	13,327
EDN100/AA	8/5/2013	602095	ELEM TEACHER	Certificated	T02	05	T	A	1.00	50,778	1.00	43,759
EDN150/FA	8/5/2013	69637	SPEC ED TEACHER	Certificated	T02	05	P	A	1.00	50,043	1.00	33,169
EDN150/FA	8/5/2013	603208	SPEC ED TEACHER	Certificated	T02	05	T	A			1.00	43,759
EDN150/FA	8/5/2013	56746	EDUC ASST I	Y	SR08	03	P	A	0.75	18,338	0.75	9,995
EDN100/DB	8/5/2013	79806	SECONDARY TEACHER	Certificated	T02	05	T	N			1.00	43,759
EDN150/FA	8/5/2013	602351	GEN EDUC/ARTICLE VI TCHR	Certificated	T02	05	T	A	1.00	45,248	1.00	43,759
EDN100/AA	8/5/2013	29431	SCHOOL HEALTH AIDE	N	SR09	03	P	A	1.00	21,576	1.00	13,867
EDN150/YC	8/5/2013	800861	BEHAVIORAL HLTH SPCLT III	N	SR20	13	T	A	1.00	42,066	1.00	22,745
EDN150/FA	8/5/2013	58924	EDUC ASST I	Y	SR08	03	P	A	0.75	18,338	0.75	9,995
EDN150/YC	8/5/2013	800436	SCHOOL PSYCHOLOGIST	Y	SR24	13	P	A	1.00	62,235	1.00	53,364
EDN100/AA	8/5/2013	66491	SECONDARY TEACHER	Certificated	T03	05	P	A	1.00	57,657	1.00	47,259
EDN100/AA	8/5/2013	39008	OFFICE ASSISTANT III	N	SR08	03	P	A	1.00	25,101	1.00	13,327
EDN150/SA	8/5/2013	56275	SPEECH PATHOLOGIST IV	Y	SR22	13	P	A	1.00	54,027	1.00	24,613
EDN100/BX	8/6/2013	802997	SCHOOL DORMITORY ATTENDANT	N	HE03	10	T	A			1.00	17,539
EDN100/AA	8/6/2013	56410	OFFICE ASSISTANT III	N	SR08	03	P	A	0.50	14,686	0.50	12,834
EDN150/YC	8/6/2013	58348	BEHAVIORAL HLTH SPCLT III	N	SR20	13	P	A	1.00	42,066	1.00	22,745
EDN100/AA	8/6/2013	67498	SECONDARY TEACHER	Certificated	T02	05	P	A	1.00	44,774	1.00	33,169
EDN100/AA	8/6/2013	802643	SCHOOL SECURITY ATTENDANT	N	SR07	03	T	A			1.00	12,798
EDN150/YC	8/6/2013	802220	EDUC ASST I	Y	SR08	03	T	A			1.00	13,327
EDN100/CB	8/6/2013	800666	OFFICE ASSISTANT III	N	SR08	03	T	A			1.00	13,327
EDN300/KO	8/6/2013	58570	PERSONNEL CLERK V	N	SR13	03	P	A	1.00	32,662	1.00	16,211
EDN100/AA	8/7/2013	65018	SECONDARY TEACHER	Certificated	T03	05	P	A	1.00	50,290	1.00	47,259
EDN100/AA	8/7/2013	601234	ELEM TEACHER	Certificated	T02	05	T	A			1.00	43,759
EDN100/AA	8/7/2013	802653	DP USER SUPPORT TECH II	N	SR15	03	T	A			1.00	17,528
EDN400/MD	8/7/2013	802835	CAFETERIA HELPER	N	BC02	01	T	B			0.50	16,614
EDN150/YC	8/7/2013	58409	BEHAVIORAL HLTH SPCLT III	N	SR20	13	P	A	1.00	53,264	1.00	22,745
EDN150/YG	8/8/2013	801795	EDUC ASST I	Y	SR08	03	T	A			1.00	13,327
EDN100/AA	8/8/2013	604436	SECONDARY TEACHER	Certificated	T01	05	T	A			1.00	30,534
EDN150/YG	8/8/2013	801705	EDUC ASST I	Y	SR08	03	T	A			1.00	13,327
EDN150/YC	8/8/2013	800384	SCHOOL PSYCHOLOGIST	Y	SR24	13	P	A	1.00	54,194	1.00	27,713

<u>Prog ID/Org</u>	<u>New Hire Effective Date</u>	<u>Position Number</u>	<u>Position Title</u>	<u>Exempt (Y/N)</u>	<u>SR Level</u>	<u>BU Code</u>	<u>T/P</u>	<u>MOF</u>	<u>Budgeted FTE</u>	<u>Budgeted Salary</u>	<u>Actual FTE</u>	<u>Actual Salary</u>
EDN150/YC	8/8/2013	27394	SCHOOL PSYCHOLOGIST	Y	SR24	13	P	A	1.00	54,194	1.00	27,713
EDN100/AA	8/9/2013	47650	OFFICE ASSISTANT II	N	SR06	03	P	A	1.00	27,143	0.50	11,844
EDN150/FA	8/9/2013	802566	EDUC ASST III	Y	SR12	03	P	A			1.00	25,030
EDN100/AA	8/9/2013	802616	SCHOOL CUSTODIAN II	N	BC02	01	T	A			0.50	8,629
EDN150/YC	8/9/2013	59636	BEHAVIORAL HLTH SPCLT III	N	SR20	13	T	A	1.00	42,066	1.00	43,812
EDN100/AA	8/9/2013	72658	ELEM TEACHER	Certificated	T02	05	P	A	1.00	42,204	1.00	43,759
EDN100/AA	8/12/2013	19031	SCHOOL CUSTODIAN II	N	BC02	01	P	A	0.50	16,247	0.50	16,614
EDN100/AA	8/12/2013	604122	ELEM TEACHER	Certificated	T02	05	T	A			1.00	43,759
EDN100/AA	8/12/2013	71315	SECONDARY TEACHER	Certificated	T02	05	P	A	1.00	66,897	1.00	33,169
EDN100/AA	8/12/2013	64796	SECONDARY TEACHER	Certificated	T02	05	P	A	1.00	31,990	1.00	33,169
EDN100/AA	8/12/2013	71822	SECONDARY TEACHER	Certificated	T03	05	T	A	1.00	46,601	1.00	47,259
EDN150/YC	8/12/2013	800442	SCHOOL PSYCHOLOGIST	Y	SR24	13	P	A	1.00	54,194	1.00	53,364
EDN100/AA	8/12/2013	60134	ELEM TEACHER	Certificated	T03	05	P	A	1.00	70,911	1.00	47,259
EDN100/AA	8/12/2013	67570	ELEM TEACHER	Certificated	T03	05	P	A	1.00	42,204	1.00	48,678
EDN150/FA	8/12/2013	600118	SPEC ED TEACHER	Certificated	T02	05	T	A			1.00	33,169
EDN100/AA	8/12/2013	60182	SECONDARY TEACHER	Certificated	T03	05	P	A	1.00	57,657	1.00	48,678
EDN150/FA	8/12/2013	73830	SPEC ED TEACHER	Certificated	T02	05	P	A	1.00	46,268	1.00	43,759
EDN100/AA	8/12/2013	66136	ELEM TEACHER	Certificated	T02	05	P	A	1.00	59,388	1.00	43,759
EDN200/GN	8/12/2013	58098	OFFICE ASSISTANT III	N	SR08	03	P	A	1.00	31,851	1.00	13,327
EDN100/AA	8/12/2013	65546	SECONDARY TEACHER	Certificated	T03	05	P	A	1.00	68,108	1.00	48,678
EDN150/FA	8/12/2013	603291	SPEC ED TEACHER	Certificated	T03	05	T	A			1.00	47,259
EDN150/SA	8/12/2013	30456	COMMUNICATION AIDE	Y	SR12	03	P	A	1.00	25,051	1.00	15,595
EDN150/FA	8/13/2013	65159	SPEC ED TEACHER	Certificated	T03	05	P	A	1.00	63,955	1.00	48,678
EDN150/YC	8/13/2013	801826	BEHAVIORAL HLTH SPCLT III	N	SR20	13	P	A	1.00	42,066	1.00	22,745
EDN100/AA	8/14/2013	65910	COUNSELOR	Certificated	T03	05	P	A	1.00	48,356	1.00	47,259
EDN150/FA	8/14/2013	800201	EDUC ASST III	Y	SR12	03	T	A	1.00	25,407	1.00	25,030
EDN150/YC	8/14/2013	59795	SCHOOL PSYCHOLOGIST	Y	SR24	13	T	A	1.00	42,066	1.00	27,713
EDN150/FA	8/15/2013	602128	SPEC ED TEACHER	Certificated	T03	05	T	A	1.00	44,823	1.00	48,678
EDN150/NB	8/15/2013	801445	EDUC ASST II	Y	SR10	03	T	N			1.00	23,130
EDN100/AA	8/19/2013	65699	SECONDARY TEACHER	Certificated	T02	05	T	A	1.00	48,356	1.00	33,169
EDN150/FA	8/19/2013	56836	EDUC ASST II	Y	SR10	03	T	A	1.00	24,450	1.00	23,130
EDN150/NB	8/19/2013	802222	EDUC ASST I	Y	SR08	03	T	N			1.00	13,327
EDN400/MD	8/19/2013	11410	SCHOOL COOK II	N	BC06	01	P	B	1.00	38,436	1.00	38,436
EDN400/MD	8/19/2013	58897	CAFETERIA HELPER	N	BC02	01	T	B			0.50	8,629
EDN100/AA	8/19/2013	602874	ELEM TEACHER	Certificated	T03	05	T	A			1.00	47,259
EDN150/FA	8/19/2013	802945	EDUC ASST I	Y	SR08	03	P	A			0.50	6,664
EDN200/GN	8/19/2013	32180	BILINGUAL/BICULTURAL S/H ASST	Y	SR11	03	T	A	0.50	14,176	0.50	7,484
EDN400/MD	8/19/2013	59917	CAFETERIA HELPER	N	BC02	01	T	B			0.50	16,614
EDN400/MD	8/19/2013	16982	CAFETERIA HELPER	N	BC02	01	P	A			0.50	8,629
EDN100/AA	8/19/2013	801806	SCHOOL CUSTODIAN II	N	BC02	01	P	A	0.50	16,247	0.50	16,614
EDN150/FA	8/19/2013	68196	SPEC ED TEACHER	Certificated	T03	05	P	A	1.00	44,920	1.00	47,259
EDN100/AA	8/19/2013	802948	OFFICE ASSISTANT I	N	SR04	03	T	A			1.00	21,948
EDN100/AA	8/19/2013	69521	SECONDARY TEACHER	Certificated	T03	05	P	A	1.00	51,556	1.00	48,678
EDN150/FA	8/19/2013	802337	EDUC ASST I	Y	SR08	03	P	A	1.00	24,450	1.00	13,327
EDN100/AA	8/19/2013	601349	SECONDARY TEACHER	Certificated	T02	05	T	A			1.00	33,169
EDN100/AA	8/19/2013	603963	ELEM TEACHER	Certificated	T02	05	T	A			1.00	43,759
EDN100/DB	8/19/2013	23101	ACCOUNT CLERK II	N	SR08	03	T	N			1.00	25,668

Department of Education
New Hires

Table 16

<u>Prog ID/Org</u>	<u>New Hire Effective Date</u>	<u>Position Number</u>	<u>Position Title</u>	<u>Exempt (Y/N)</u>	<u>SR Level</u>	<u>BU Code</u>	<u>T/P</u>	<u>MOF</u>	<u>Budgeted FTE</u>	<u>Budgeted Salary</u>	<u>Actual FTE</u>	<u>Actual Salary</u>
EDN150/FA	8/19/2013	601269	SPEC ED TEACHER	Certificated	T03	05	T	A			1.00	48,678
EDN150/SA	8/19/2013	30438	SPEECH PATHOLOGIST IV	Y	SR22	13	P	A	1.00	53,507	1.00	47,400
EDN400/MD	8/19/2013	801488	CAFETERIA HELPER	N	BC02	01	T	B	0.50	16,614	0.50	16,614
EDN100/AA	8/19/2013	601005	ELEM TEACHER	Certificated	T02	05	T	A			1.00	45,072
EDN150/FA	8/19/2013	57421	EDUC ASST III	Y	SR12	03	T	A	0.75	19,056	0.75	18,773
EDN400/OC	8/19/2013	34313	ENGINEER V	N	SR26	13	P	A	1.00	63,024	1.00	57,720
EDN100/AA	8/19/2013	600225	ELEM TEACHER	Certificated	T03	05	T	A	1.00	42,204	1.00	47,259
EDN100/AA	8/19/2013	801139	OFFICE ASSISTANT III	N	SR08	03	T	A	1.00	25,101	1.00	25,668
EDN100/AA	8/19/2013	802591	DP USER SUPPORT TECH II	N	SR15	03	T	A			1.00	17,528
EDN150/YG	8/19/2013	801708	EDUC ASST I	Y	SR08	03	T	A			1.00	13,327
EDN100/AA	8/19/2013	73193	SECONDARY TEACHER	Certificated	T02	05	T	A	1.00	45,579	1.00	45,072
EDN150/SA	8/19/2013	29804	SPEECH PATHOLOGIST II	Y	SR18	13	P	A	1.00	54,027	1.00	21,049
EDN150/FA	8/20/2013	66291	GEN EDUC/ARTICLE VI TCHR	Certificated	T03	05	P	A			1.00	35,822
EDN400/MD	8/20/2013	801267	CAFETERIA HELPER	N	BC02	01	T	B			0.50	8,629
EDN100/AA	8/20/2013	40982	SCHOOL CUSTODIAN II	N	BC02	01	P	A	0.50	16,247	0.50	8,629
EDN100/AA	8/20/2013	62425	ELEM TEACHER	Certificated	T03	05	P	A	1.00	45,579	1.00	47,259
EDN150/YC	8/20/2013	29155	SCHOOL PSYCHOLOGIST	Y	SR24	13	P	A	1.00	54,194	1.00	53,364
EDN100/BX	8/20/2013	802976	SCHOOL DORMITORY ATTENDANT	N	HE03	10	P	A			1.00	17,539
EDN150/YC	8/21/2013	58399	BEHAVIORAL HLTH SPLCT III	N	SR20	13	T	A	1.00	42,066	1.00	22,745
EDN150/FA	8/21/2013	71992	SPEC ED TEACHER	Certificated	T02	05	P	A	1.00	40,381	1.00	43,759
EDN150/FA	8/22/2013	57508	EDUC ASST I	Y	SR08	03	T	A	0.75	19,796	1.00	13,327
EDN100/AA	8/22/2013	601281	ELEM TEACHER	Certificated	T02	05	T	A			1.00	43,759
EDN100/AA	8/23/2013	600319	ELEM TEACHER	Certificated	T02	05	T	A	1.00	45,579	1.00	43,759
EDN100/AA	8/23/2013	602282	12-MO SECONDARY TEACHER	Certificated	T02	05	T	A			1.00	52,381
EDN100/AA	8/23/2013	603483	ELEM TEACHER	Certificated	T02	05	T	A			1.00	43,759
EDN100/AA	8/23/2013	601235	ELEM TEACHER	Certificated	T03	05	T	A	1.00	45,579	1.00	48,678
EDN100/BX	8/24/2013	802976	SCHOOL DORMITORY ATTENDANT	N	HE03	10	P	A			1.00	17,539
EDN100/BX	8/24/2013	802998	SCHOOL DORMITORY ATTENDANT	N	HE03	10	T	A			1.00	17,539
EDN100/AA	8/26/2013	66266	SECONDARY TEACHER	Certificated	T03	05	P	A	1.00	77,421	1.00	47,259
EDN100/AA	8/26/2013	801067	OFFICE ASSISTANT III	N	SR08	03	T	A	0.50	12,550	0.50	6,664
EDN150/FA	8/26/2013	802646	EDUC ASST I	Y	SR08	03	P	A			1.00	13,327
EDN100/AA	8/26/2013	71311	SECONDARY TEACHER	Certificated	T02	05	P	A	1.00	60,049	1.00	33,169
EDN100/AA	8/26/2013	603630	ELEM TEACHER	Certificated	T02	05	T	A			1.00	33,169
EDN100/AA	8/26/2013	73412	SECONDARY TEACHER	Certificated	T02	05	P	A	0.50	22,387	1.00	43,759
EDN100/AA	8/26/2013	600738	SECONDARY TEACHER	Certificated	T02	05	T	A	1.00	42,204	1.00	43,759
EDN500/WA	8/26/2013	800752	ACCOUNT CLERK III	N	SR11	03	T	W			1.00	28,836
EDN100/AA	8/26/2013	802978	SCHOOL CUSTODIAN II	N	BC02	01	P	A			1.00	17,258
EDN100/BM	8/26/2013	48257	ATHLETIC HLTH CARE TRAINER	Y	SR22	13	P	A	1.00	42,073	1.00	24,613
EDN100/AA	8/26/2013	69017	ELEM TEACHER	Certificated	T02	05	P	A	1.00	66,897	1.00	43,759
EDN100/AA	8/26/2013	601280	ELEM TEACHER	Certificated	T03	05	T	A			1.00	47,259
EDN150/FA	8/26/2013	600593	GEN EDUC/ARTICLE VI TCHR	Certificated	T02	05	T	A			1.00	43,759
EDN150/YC	8/26/2013	58091	HUMAN SVCS PROF IV	N	SR22	13	P	A	1.00	42,066	1.00	24,613
EDN150/YG	8/26/2013	801353	HUMAN SVCS PROF IV	N	SR22	13	P	A	1.00	42,049	1.00	24,613
EDN150/FA	8/26/2013	75918	GEN EDUC/ARTICLE VI TCHR	Certificated	T02	05	P	A	1.00	55,035	1.00	33,169
EDN100/AA	8/28/2013	74908	ELEM TEACHER	Certificated	T02	05	T	A	1.00	43,470	1.00	43,759
EDN100/AA	8/28/2013	45221	SCHOOL CUSTODIAN II	N	BC02	01	P	A	0.50	16,247	0.50	16,614
EDN100/AA	8/28/2013	603410	ELEM TEACHER	Certificated	T02	05	T	A			1.00	45,072

<u>Prog ID/Org</u>	<u>New Hire Effective Date</u>	<u>Position Number</u>	<u>Position Title</u>	<u>Exempt (Y/N)</u>	<u>SR Level</u>	<u>BU Code</u>	<u>T/P</u>	<u>MOF</u>	<u>Budgeted FTE</u>	<u>Budgeted Salary</u>	<u>Actual FTE</u>	<u>Actual Salary</u>
EDN150/FA	8/29/2013	801160	EDUC ASST III	Y	SR12	03	T	A	1.00	28,544	1.00	25,030
EDN150/FA	8/29/2013	58118	EDUC ASST I	Y	SR08	03	P	A	0.75	19,056	0.75	9,995
EDN100/AA	8/30/2013	601245	ELEM TEACHER	Certificated	T02	05	T	A			1.00	43,759
EDN100/AA	8/30/2013	66701	SECONDARY TEACHER	Certificated	T03	05	P	A	1.00	57,657	1.00	48,678
EDN100/AA	8/30/2013	71194	ELEM TEACHER	Certificated	T03	05	P	A	1.00	57,657	1.00	48,678
EDN150/FA	9/3/2013	61829	SPEC ED TEACHER	Certificated	T02	05	P	A			0.50	16,584
EDN150/FA	9/3/2013	64414	SPEC ED TEACHER	Certificated	T02	05	P	A	1.00	53,256	0.50	16,584
EDN100/AA	9/3/2013	29391	SCHOOL HEALTH AIDE	N	SR09	03	P	A	1.00	25,242	1.00	13,867
EDN150/FA	9/3/2013	56679	EDUC ASST I	Y	SR08	03	P	A	0.75	18,338	0.75	9,995
EDN100/AA	9/3/2013	40033	ACCOUNT CLERK I	N	SR07	03	P	A	1.00	30,523	1.00	24,648
EDN100/AA	9/3/2013	801543	SCHOOL CUSTODIAN II	N	BC02	01	T	A	0.50	16,247	0.50	16,614
EDN150/YG	9/3/2013	801707	EDUC ASST I	Y	SR08	03	T	A			1.00	13,327
EDN100/AA	9/3/2013	601342	ELEM TEACHER	Certificated	T03	05	T	A			0.50	24,339
EDN150/FA	9/3/2013	58952	EDUC ASST I	Y	SR08	03	P	A	0.75	21,407	0.75	9,995
EDN400/MD	9/3/2013	55499	CAFETERIA HELPER	N	BC02	01	T	N			0.50	8,629
EDN100/AA	9/3/2013	22219	SCHOOL CUSTODIAN II	N	BC02	01	P	A	0.50	16,247	0.50	16,614
EDN150/FA	9/3/2013	34893	EDUC ASST II	Y	SR10	03	P	A	1.00	36,153	1.00	23,130
EDN400/OC	9/3/2013	17063	OFFICE ASSISTANT IV	N	SR10	03	P	A	1.00	24,927	1.00	14,407
EDN100/AA	9/3/2013	62946	ELEM TEACHER	Certificated	T02	05	P	A	1.00	59,388	1.00	43,759
EDN100/AA	9/3/2013	46021	OFFICE ASSISTANT II	N	SR06	03	P	A	0.50	12,550	0.50	11,844
EDN100/AA	9/3/2013	63266	ELEM TEACHER	Certificated	T03	05	P	A	1.00	64,325	1.00	47,259
EDN100/BM	9/3/2013	52457	ATHLETIC HLTH CARE TRAINER	Y	SR22	13	P	A	1.00	49,251	1.00	47,400
EDN150/FA	9/3/2013	56687	EDUC ASST I	Y	SR08	03	P	A	0.75	18,338	0.75	9,995
EDN150/YC	9/3/2013	58519	BEHAVIORAL HLTH SPLCT III	N	SR20	13	P	A	1.00	43,761	1.00	22,745
EDN100/AA	9/3/2013	49232	SCHOOL CUSTODIAN II	N	BC02	01	P	A	0.50	16,247	0.50	8,629
EDN150/FA	9/3/2013	801891	EDUC ASST I	Y	SR08	03	T	A	0.75	18,338	0.75	9,995
EDN150/FA	9/3/2013	62553	SPEC ED TEACHER	Certificated	T03	05	P	A	1.00	56,823	1.00	47,259
EDN100/AA	9/3/2013	40086	OFFICE ASSISTANT III	N	SR08	03	P	A	1.00	33,010	1.00	25,668
EDN100/AA	9/3/2013	801338	SCHOOL CUSTODIAN II	N	BC02	01	P	A	0.50	16,247	0.50	16,614
EDN150/YC	9/3/2013	58465	BEHAVIORAL HLTH SPLCT IV	N	SR22	13	P	A	1.00	53,264	1.00	55,488
EDN400/MD	9/3/2013	2054	SCHOOL FOOD SERVICES MGR I	N	WF06	02	P	A	1.00	40,925	1.00	41,568
EDN100/AA	9/3/2013	802973	SCHOOL CUSTODIAN II	N	BC02	01	P	A			1.00	33,228
EDN150/FA	9/3/2013	602618	12-MO STATE OFF TCHR	Certificated	T02	05	P	A			1.00	52,381
EDN150/YC	9/3/2013	58421	BEHAVIORAL HLTH SPLCT III	N	SR20	13	T	A	1.00	45,533	1.00	22,745
EDN100/AA	9/3/2013	29402	SCHOOL HEALTH AIDE	N	SR09	03	P	A	1.00	21,576	1.00	13,867
EDN100/AA	9/3/2013	72358	SECONDARY TEACHER	Certificated	T02	05	P	A	1.00	50,290	1.00	43,759
EDN150/FB	9/3/2013	75795	SPEC ED TEACHER	Certificated	T02	05	P	A	1.00	39,795	1.00	50,760
EDN100/AA	9/3/2013	18032	OFFICE ASSISTANT III	N	SR08	03	P	A	1.00	38,608	1.00	13,327
EDN100/AA	9/3/2013	601290	SECONDARY TEACHER	Certificated	T02	05	T	A			1.00	43,759
EDN100/BJ	9/3/2013	604430	SPECIAL SCH TEACHER	Certificated	T02	05	T	A			1.00	33,169
EDN100/AA	9/4/2013	802980	OFFICE ASSISTANT III	N	SR08	03	P	A			0.50	6,664
EDN100/AA	9/4/2013	601238	SECONDARY TEACHER	Certificated	T02	05	T	A			1.00	45,072
EDN150/YC	9/4/2013	58747	BEHAVIORAL HLTH SPLCT IV	N	SR22	13	P	A	1.00	43,761	1.00	49,308
EDN100/AA	9/4/2013	69195	SECONDARY TEACHER	Certificated	T03	05	P	A	1.00	45,579	1.00	47,259
EDN200/GN	9/4/2013	19051	PRIVATE SECRETARY I	N	SR20	03	P	A	1.00	40,342	1.00	42,684
EDN100/AA	9/6/2013	63090	ELEM TEACHER	Certificated	T02	05	P	A	1.00	43,470	1.00	33,169
EDN300/KO	9/9/2013	604125	PERSONNEL SPECIALIST II	Certificated	E07	06	P	A			1.00	77,069

Department of Education
New Hires

Table 16

<u>Prog ID/Org</u>	<u>New Hire Effective Date</u>	<u>Position Number</u>	<u>Position Title</u>	<u>Exempt (Y/N)</u>	<u>SR Level</u>	<u>BU Code</u>	<u>T/P</u>	<u>MOF</u>	<u>Budgeted FTE</u>	<u>Budgeted Salary</u>	<u>Actual FTE</u>	<u>Actual Salary</u>
EDN100/AA	9/9/2013	68857	SECONDARY TEACHER	Certificated	T03	05	P	A	1.00	45,579	1.00	38,004
EDN100/AA	9/9/2013	63665	ELEM TEACHER	Certificated	T02	05	P	A	1.00	57,657	1.00	43,759
EDN150/FA	9/9/2013	602343	SPEC ED TEACHER	Certificated	T02	05	T	A			1.00	33,169
EDN150/FA	9/9/2013	65043	GEN EDUC/ARTICLE VI TCHR	Certificated	T02	05	P	A	1.00	43,507	1.00	43,759
EDN150/SA	9/9/2013	30504	COMMUNICATION AIDE	Y	SR12	03	P	A	0.75	21,107	0.75	11,696
EDN100/AA	9/9/2013	16327	SCHOOL CUSTODIAN II	N	BC02	01	P	A	1.00	32,494	1.00	33,228
EDN300/KO	9/9/2013	67842	PERS REGIONAL OFFICER II	Certificated	E07	06	P	A	1.00	72,876	1.00	78,146
EDN150/YG	9/9/2013	801669	BEHAVIORAL HLTH SPCLT IV	N	SR22	13	T	A			1.00	49,308
EDN150/FA	9/9/2013	63181	SPEC ED TEACHER	Certificated	T02	05	P	A	1.00	40,381	1.00	45,072
EDN100/AA	9/9/2013	601313	ELEM TEACHER	Certificated	T03	05	T	A			1.00	48,678
EDN100/AA	9/9/2013	71089	ELEM TEACHER	Certificated	T03	05	P	A	1.00	45,579	1.00	48,678
EDN100/DB	9/9/2013	802052	ACCOUNT CLERK II	N	SR08	03	T	N			0.50	6,664
EDN100/AA	9/9/2013	65044	ELEM TEACHER	Certificated	T03	05	P	A	1.00	64,949	1.00	47,259
EDN400/OD	9/9/2013	37392	SCHOOL CUSTODIAN II	N	BC02	01	P	A	0.50	14,922	0.50	8,629
EDN100/AA	9/10/2013	601326	SPEC ED TEACHER	Certificated	T03	05	T	A			1.00	47,259
EDN100/AA	9/11/2013	604232	SECONDARY TEACHER	Certificated	T02	05	T	A			0.50	16,584
EDN150/NB	9/11/2013	802449	EDUC ASST I	Y	SR08	03	T	N			1.00	13,327
EDN150/FA	9/12/2013	58933	EDUC ASST I	Y	SR08	03	P	A	0.75	18,338	1.00	13,327
EDN150/FA	9/12/2013	29763	EDUC ASST I	Y	SR08	03	P	A	1.00	32,138	1.00	13,327
EDN150/SA	9/12/2013	34624	COMMUNICATION AIDE	Y	SR12	03	P	A	0.75	24,705	0.75	11,696
EDN150/FA	9/12/2013	72377	SPEC ED TEACHER	Certificated	T03	05	P	A	1.00	46,268	1.00	48,678
EDN100/AA	9/12/2013	65471	SECONDARY TEACHER	Certificated	T02	05	P	A	1.00	50,290	1.00	33,169
EDN100/AA	9/13/2013	601327	ELEM TEACHER	Certificated	T03	05	T	A			1.00	48,678
EDN100/AA	9/16/2013	65350	SECONDARY TEACHER	Certificated	T03	05	P	A	1.00	57,706	1.00	48,678
EDN150/FA	9/16/2013	57232	EDUC ASST II	Y	SR10	03	P	A	0.75	18,338	0.75	17,348
EDN100/AA	9/16/2013	58831	SCHOOL CUSTODIAN II	N	BC02	01	P	A	0.50	16,247	0.50	16,614
EDN150/FA	9/16/2013	801359	EDUC ASST I	Y	SR08	03	P	A			1.00	13,327
EDN150/YC	9/16/2013	58497	BEHAVIORAL HLTH SPCLT III	N	SR20	13	P	A	1.00	53,264	1.00	22,745
EDN100/AA	9/16/2013	802820	OFFICE ASSISTANT III	N	SR08	03	T	A			0.50	6,664
EDN100/DB	9/16/2013	23369	EDUC ASST II	Y	SR10	03	T	N			1.00	23,130
EDN150/YG	9/16/2013	801715	EDUC ASST I	Y	SR08	03	T	A	1.00	25,053	1.00	13,327
EDN100/AA	9/16/2013	46927	SCHOOL CUSTODIAN II	N	BC02	01	P	A	0.50	16,247	0.50	16,614
EDN100/AA	9/16/2013	801545	OFFICE ASSISTANT III	N	SR08	03	T	A	1.00	25,101	1.00	25,668
EDN100/AA	9/16/2013	36296	OFFICE ASSISTANT III	N	SR08	03	P	A	1.00	28,199	1.00	13,327
EDN100/AA	9/16/2013	604280	ELEM TEACHER	Certificated	T02	05	T	A			1.00	43,759
EDN150/FA	9/16/2013	601626	SPEC ED TEACHER	Certificated	T02	05	T	A			1.00	43,759
EDN100/AA	9/16/2013	602793	ELEM TEACHER	Certificated	T02	05	T	A			1.00	43,759
EDN100/AA	9/16/2013	50454	OFFICE ASSISTANT III	N	SR08	03	P	A	0.50	12,550	1.00	25,668
EDN100/AA	9/16/2013	601302	ELEM TEACHER	Certificated	T03	05	T	A			1.00	48,678
EDN100/CB	9/16/2013	801393	LEGAL CLERK	N	SR14	03	T	W			1.00	32,424
EDN150/YG	9/16/2013	801521	EDUC ASST III	Y	SR12	03	T	A			1.00	25,030
EDN100/AA	9/16/2013	802781	LIBRARY ASSISTANT II	N	SR05	03	T	A			1.00	22,776
EDN150/FA	9/16/2013	803032	EDUC ASST II	Y	SR10	03	T	A			0.75	17,348
EDN150/FA	9/16/2013	601360	GEN EDUC/ARTICLE VI TCHR	Certificated	T02	05	T	A			1.00	33,169
EDN100/DB	9/16/2013	59583	OFFICE ASSISTANT III	N	SR08	03	T	N			1.00	13,327
EDN100/AA	9/16/2013	600653	SECONDARY TEACHER	Certificated	T02	05	T	A			1.00	33,169
EDN100/AA	9/17/2013	801544	SCHOOL CUSTODIAN II	N	BC02	01	T	A			0.50	16,614

Department of Education
New Hires

Table 16

<u>Prog ID/Org</u>	<u>New Hire Effective Date</u>	<u>Position Number</u>	<u>Position Title</u>	<u>Exempt (Y/N)</u>	<u>SR Level</u>	<u>BU Code</u>	<u>T/P</u>	<u>MOF</u>	<u>Budgeted FTE</u>	<u>Budgeted Salary</u>	<u>Actual FTE</u>	<u>Actual Salary</u>
EDN100/AA	9/17/2013	16340	SCHOOL CUSTODIAN II	N	BC02	01	P	A	0.50	16,247	0.50	16,614
EDN100/AA	9/17/2013	74960	SECONDARY TEACHER	Certificated	T02	05	P	A	1.00	52,302	1.00	33,169
EDN100/AA	9/17/2013	60594	ELEM TEACHER	Certificated	T02	05	P	A	1.00	68,845	1.00	43,759
EDN100/AA	9/18/2013	68970	ELEM TEACHER	Certificated	T02	05	P	A	1.00	49,806	1.00	45,072
EDN100/AA	9/18/2013	802982	DP USER SUPPORT TECH II	N	SR15	03	T	A			1.00	17,528
EDN150/FA	9/19/2013	28353	EDUC ASST I	Y	SR08	03	P	A	1.00	24,450	1.00	21,390
EDN100/AA	9/19/2013	16422	SCHOOL CUSTODIAN II	N	BC02	01	P	A	0.50	16,247	0.50	16,614
EDN100/BM	9/19/2013	52456	ATHLETIC HLTH CARE TRAINER	Y	SR22	13	P	A	1.00	42,073	1.00	24,613
EDN100/AA	9/19/2013	65867	SECONDARY TEACHER	Certificated	T02	05	P	A	1.00	48,825	1.00	33,169
EDN100/AA	9/19/2013	63918	ELEM TEACHER	Certificated	T02	05	P	A	1.00	70,911	1.00	43,759
EDN100/AA	9/20/2013	73692	COUNSELOR	Certificated	T03	05	P	A	1.00	61,168	1.00	47,259
EDN150/FA	9/20/2013	76169	SPEC ED TEACHER	Certificated	T02	05	P	A	1.00	43,611	1.00	43,759
EDN100/AA	9/23/2013	71633	ELEM TEACHER	Certificated	T03	05	P	A	1.00	73,038	1.00	47,259
EDN100/AA	9/23/2013	16512	SCHOOL CUSTODIAN II	N	BC02	01	P	A	0.50	16,247	0.50	16,614
EDN100/AA	9/23/2013	601358	SPEC ED TEACHER	Certificated	T03	05	T	A			1.00	47,259
EDN100/AA	9/23/2013	600696	ELEM TEACHER	Certificated	T02	05	T	A			0.50	21,879
EDN100/AA	9/23/2013	601287	ELEM TEACHER	Certificated	T02	05	T	A			1.00	45,072
EDN150/YG	9/23/2013	800883	EDUC ASST III	Y	SR12	03	P	A			1.00	25,030
EDN100/AA	9/23/2013	67814	SECONDARY TEACHER	Certificated	T02	05	P	A	1.00	47,969	1.00	33,169
EDN100/AA	9/23/2013	601340	COUNSELOR	Certificated	T03	05	T	A	1.00	61,168	1.00	47,259
EDN100/AA	9/23/2013	600856	ELEM TEACHER	Certificated	T02	05	T	A	1.00	48,356	1.00	43,759
EDN150/FA	9/23/2013	64288	SPEC ED TEACHER	Certificated	T03	05	P	A	1.00	43,611	1.00	47,259
EDN150/FA	9/23/2013	75505	SPEC ED TEACHER	Certificated	T02	05	T	A	1.00	55,167	1.00	33,169
EDN300/KO	9/24/2013	59128	PERSONNEL CLERK IV	N	SR11	03	P	A	1.00	33,961	1.00	14,969
EDN150/FA	9/25/2013	54501	EDUC ASST III	Y	SR12	03	T	A	0.75	18,338	0.75	18,773
EDN100/AA	9/26/2013	63384	ELEM TEACHER	Certificated	T02	05	P	A	1.00	51,905	1.00	43,759
EDN150/NB	9/26/2013	58188	EDUC ASST I	Y	SR08	03	T	N			1.00	21,390
EDN150/YG	9/30/2013	600543	DIST OFF TCHR	Certificated	T03	05	T	A			1.00	47,259
EDN100/AA	9/30/2013	29377	SCHOOL HEALTH AIDE	N	SR09	03	P	A	1.00	22,413	1.00	13,867
EDN150/NB	9/30/2013	801162	EDUC ASST III	Y	SR12	03	T	N			1.00	25,030
EDN100/AA	9/30/2013	64559	SECONDARY TEACHER	Certificated	T03	05	P	A	1.00	61,408	1.00	48,678
EDN150/FA	9/30/2013	63201	SPEC ED TEACHER	Certificated	T02	05	P	A	1.00	48,118	1.00	33,169
EDN150/FA	9/30/2013	74759	SPEC ED TEACHER	Certificated	T02	05	P	A	1.00	40,381	1.00	43,759
EDN100/AA	9/30/2013	603568	ELEM TEACHER	Certificated	T02	05	T	A			1.00	43,759
EDN150/FA	9/30/2013	76319	SPEC ED TEACHER	Certificated	T03	05	P	A	1.00	43,611	1.00	48,678
EDN100/AA	9/30/2013	602414	ELEM TEACHER	Certificated	T03	05	T	A			1.00	47,259
EDN100/AA	10/1/2013	802358	SCHOOL SECURITY ATTENDANT	N	SR07	03	T	A			0.50	6,399
EDN400/MD	10/1/2013	10258	CAFETERIA HELPER	N	BC02	01	P	A	1.00	26,463	0.50	8,797
EDN400/MD	10/1/2013	50838	CAFETERIA HELPER	N	BC02	01	T	B	0.50	16,614	0.50	16,944
EDN150/YC	10/1/2013	802610	EDUC ASST I	Y	SR08	03	T	A			1.00	13,327
EDN150/FA	10/1/2013	802871	EDUC ASST II	Y	SR10	03	P	A			0.75	17,348
EDN150/FA	10/1/2013	55049	EDUC ASST II	Y	SR10	03	P	A	0.50	12,226	0.63	14,456
EDN100/AA	10/1/2013	53259	EDUC ASST III	Y	SR12	03	P	A	1.00	31,067	1.00	25,030
EDN150/FA	10/1/2013	603684	SPEC ED TEACHER	Certificated	T03	05	T	A			1.00	47,259
EDN150/FA	10/1/2013	802565	EDUC ASST III	Y	SR12	03	P	A			1.00	25,030
EDN150/FA	10/1/2013	800202	EDUC ASST I	Y	SR08	03	T	A	1.00	24,450	1.00	13,327
EDN400/MD	10/1/2013	59669	CAFETERIA HELPER	N	BC02	01	T	B			0.50	16,944

Department of Education
New Hires

Table 16

<u>Prog ID/Org</u>	<u>New Hire Effective Date</u>	<u>Position Number</u>	<u>Position Title</u>	<u>Exempt (Y/N)</u>	<u>SR Level</u>	<u>BU Code</u>	<u>T/P</u>	<u>MOF</u>	<u>Budgeted FTE</u>	<u>Budgeted Salary</u>	<u>Actual FTE</u>	<u>Actual Salary</u>
EDN100/AA	10/1/2013	29314	SCHOOL HEALTH AIDE	N	SR09	03	P	A	1.00	27,291	1.00	13,867
EDN100/AA	10/1/2013	802897	EDUC ASST I	Y	SR08	03	T	A			0.75	16,043
EDN100/AA	10/1/2013	601399	ELEM TEACHER	Certificated	T02	05	T	A			0.50	21,879
EDN100/AA	10/1/2013	29306	SCHOOL HEALTH AIDE	N	SR09	03	P	A	1.00	21,576	1.00	13,867
EDN400/MD	10/1/2013	39559	CAFETERIA HELPER	N	BC02	01	T	B			0.50	16,944
EDN200/GN	10/1/2013	57947	ADMINISTRATIVE SERVICES ASST	N	SR22	13	P	A	1.00	45,136	1.00	53,364
EDN150/YG	10/1/2013	801731	EDUC ASST II	Y	SR10	03	T	A			1.00	23,130
EDN150/YC	10/1/2013	800757	SCHOOL PSYCHOLOGIST	Y	SR24	13	P	A	1.00	54,194	1.00	53,364
EDN100/BM	10/1/2013	49234	ATHLETIC HLTH CARE TRAINER	Y	SR22	13	P	A	1.00	42,073	1.00	24,613
EDN100/AA	10/1/2013	802949	SCHOOL SECURITY ATTENDANT	N	SR07	03	T	A			1.00	20,540
EDN100/AA	10/1/2013	29325	SCHOOL HEALTH AIDE	N	SR09	03	P	A	1.00	23,334	1.00	13,867
EDN400/MD	10/1/2013	46005	CAFETERIA HELPER	N	BC02	01	P	B	1.00	38,436	0.50	8,797
EDN150/FA	10/1/2013	37675	EDUC ASST III	Y	SR12	03	P	A	1.00	28,544	1.00	25,030
EDN100/AA	10/1/2013	65497	ELEM TEACHER	Certificated	T03	05	P	A	1.00	62,546	1.00	48,678
EDN150/YG	10/1/2013	802597	BEHAVIORAL HLTH SPCLT III	N	SR20	13	T	A			1.00	22,745
EDN100/AA	10/1/2013	802641	OFFICE ASSISTANT III	N	SR08	03	P	A			1.00	25,668
EDN150/FA	10/1/2013	68023	SPEC ED TEACHER	Certificated	T03	05	P	A	1.00	51,255	1.00	47,259
EDN100/AA	10/1/2013	68557	ELEM TEACHER	Certificated	T03	05	P	A	1.00	53,353	1.00	48,678
EDN150/FA	10/1/2013	74373	SPEC ED TEACHER	Certificated	T03	05	P	A	1.00	55,167	1.00	48,678
EDN400/OC	10/1/2013	17077	ENGINEER VI	N	SR28	13	P	A	1.00	81,119	1.00	85,416
EDN400/OC	10/1/2013	18558	AUTOMOTIVE MECHANIC I	N	BC10	01	P	A	1.00	41,524	1.00	24,484
EDN100/AA	10/2/2013	603999	SECONDARY TEACHER	Certificated	T02	05	T	A			1.00	43,759
EDN150/SA	10/2/2013	28717	OCC THERAPIST III	N	SR20	13	P	A	1.00	58,717	1.00	22,745
EDN100/AA	10/7/2013	801383	SCHOOL CUSTODIAN II	N	BC02	01	T	A	0.50	16,247	0.50	16,944
EDN150/FA	10/7/2013	75811	GEN EDUC/ARTICLE VI TCHR	Certificated	T02	05	P	A	1.00	42,738	1.00	43,759
EDN200/GP	10/7/2013	14687	SECRETARY II	N	SR14	03	P	A	1.00	28,971	1.00	32,424
EDN150/YG	10/7/2013	801837	EDUC ASST I	Y	SR08	03	T	A			1.00	13,327
EDN150/YC	10/7/2013	800465	SCHOOL PSYCHOLOGIST	Y	SR24	13	P	A	1.00	54,194	1.00	27,713
EDN150/YG	10/7/2013	801836	EDUC ASST I	Y	SR08	03	T	A	1.00	27,712	1.00	13,327
EDN100/AA	10/7/2013	56494	OFFICE ASSISTANT III	N	SR08	03	P	A	1.00	28,199	1.00	25,668
EDN150/YG	10/7/2013	801834	EDUC ASST I	Y	SR08	03	T	A	1.00	27,712	1.00	13,327
EDN100/AA	10/8/2013	49684	SCHOOL CUSTODIAN II	N	BC02	01	P	A	0.50	16,247	0.50	16,944
EDN500/WA	10/8/2013	800752	ACCOUNT CLERK III	N	SR11	03	T	W			1.00	14,969
EDN100/AA	10/9/2013	72366	12-MO SECONDARY TEACHER	Certificated	T02	05	P	A	1.00	60,835	1.00	53,953
EDN100/AA	10/10/2013	54884	OFFICE ASSISTANT III	N	SR08	03	T	A			1.00	25,668
EDN100/AA	10/14/2013	67205	SECONDARY TEACHER	Certificated	T02	05	P	A	1.00	49,806	1.00	33,169
EDN100/AA	10/14/2013	41719	OFFICE ASSISTANT II	N	SR06	03	P	A	1.00	26,110	1.00	23,688
EDN100/AA	10/14/2013	602387	ELEM TEACHER	Certificated	T03	05	T	A			1.00	48,678
EDN100/AA	10/14/2013	68758	SECONDARY TEACHER	Certificated	T02	05	P	A	1.00	51,905	1.00	33,169
EDN100/AA	10/14/2013	71748	ELEM TEACHER	Certificated	T03	05	P	A	1.00	46,117	1.00	47,259
EDN100/AA	10/14/2013	69238	COUNSELOR	Certificated	T03	05	P	A	1.00	51,312	1.00	48,678
EDN150/FA	10/14/2013	602044	SPEC ED TEACHER	Certificated	T02	05	T	A	1.00	43,611	1.00	43,759
EDN150/SA	10/14/2013	30708	SCH BASED OCC THRPY ASST (FP)	N	HE10	10	P	A	1.00	45,156	1.00	24,170
EDN100/BM	10/14/2013	801113	ATHLETIC HLTH CARE TRAINER	Y	SR22	13	P	A	1.00	43,768	1.00	24,613
EDN100/AA	10/14/2013	65025	ELEM TEACHER	Certificated	T03	05	P	A	1.00	58,923	1.00	47,259
EDN150/NB	10/14/2013	801027	EDUC ASST I	Y	SR08	03	T	N			1.00	13,327
EDN100/AA	10/14/2013	602648	GEN EDUC/ARTICLE VI TCHR	Certificated	T02	05	T	A			1.00	43,759

Department of Education
New Hires

Table 16

<u>Prog ID/Org</u>	<u>New Hire Effective Date</u>	<u>Position Number</u>	<u>Position Title</u>	<u>Exempt (Y/N)</u>	<u>SR Level</u>	<u>BU Code</u>	<u>T/P</u>	<u>MOF</u>	<u>Budgeted FTE</u>	<u>Budgeted Salary</u>	<u>Actual FTE</u>	<u>Actual Salary</u>
EDN100/DB	10/14/2013	801103	PERSONNEL CLERK V	N	SR13	03	T	N			1.00	16,211
EDN150/FA	10/14/2013	57164	EDUC ASST III	Y	SR12	03	T	A	1.00	24,450	1.00	25,030
EDN150/FA	10/15/2013	76006	SPEC ED TEACHER	Certificated	T02	05	P	A	1.00	69,884	1.00	33,169
EDN100/AA	10/15/2013	802506	SCHOOL SECURITY ATTENDANT	N	SR07	03	T	A			0.75	9,599
EDN150/FA	10/15/2013	66793	GEN EDUC/ARTICLE VI TCHR	Certificated	T02	05	P	A	1.00	47,057	1.00	45,072
EDN100/AA	10/15/2013	601369	ELEM TEACHER	Certificated	T02	05	T	A			1.00	43,759
EDN150/FA	10/15/2013	65760	SPEC ED TEACHER	Certificated	T02	05	P	A	1.00	30,609	1.00	33,169
EDN100/AA	10/15/2013	66675	ELEM TEACHER	Certificated	T02	05	P	A	1.00	47,969	1.00	43,759
EDN100/AA	10/15/2013	75155	SECONDARY TEACHER	Certificated	T03	05	P	A	1.00	45,579	1.00	48,678
EDN100/AA	10/15/2013	601286	ELEM TEACHER	Certificated	T02	05	T	A			1.00	43,759
EDN100/DB	10/15/2013	600713	SECONDARY TEACHER	Certificated	T02	05	T	N			1.00	43,759
EDN100/AA	10/15/2013	73412	SECONDARY TEACHER	Certificated	T02	05	P	A	0.50	22,387	1.00	45,072
EDN150/FA	10/15/2013	57089	EDUC ASST III	Y	SR12	03	T	A	1.00	24,450	1.00	25,030
EDN150/SA	10/15/2013	47673	SPEECH PATHOLOGIST IV	Y	SR22	13	P	A	1.00	54,027	1.00	24,613
EDN100/AA	10/15/2013	604298	ELEM TEACHER	Certificated	T02	05	T	A			1.00	45,072
EDN100/AA	10/15/2013	63783	SECONDARY TEACHER	Certificated	T02	05	T	A	1.00	42,204	1.00	45,072
EDN100/AA	10/15/2013	601761	ELEM TEACHER	Certificated	T02	05	T	A	1.00	45,579	1.00	33,169
EDN100/AA	10/15/2013	603649	ELEM TEACHER	Certificated	T02	05	T	A			1.00	50,760
EDN300/KF	10/16/2013	60082	BUDGET SPECIALIST II	Certificated	E07	06	P	A	1.00	97,835	1.00	77,069
EDN150/FA	10/16/2013	29640	EDUC ASST III	Y	SR12	03	P	A	0.50	12,226	0.50	12,515
EDN150/FA	10/16/2013	800160	EDUC ASST I	Y	SR08	03	T	A	0.75	18,338	0.75	16,043
EDN100/AA	10/16/2013	604363	ELEM TEACHER	Certificated	T02	05	T	A			0.50	16,584
EDN400/MD	10/16/2013	59895	CAFETERIA HELPER	N	BC02	01	T	B			0.50	16,944
EDN100/AA	10/16/2013	39925	OFFICE ASSISTANT III	N	SR08	03	P	A	1.00	25,101	1.00	25,668
EDN400/MD	10/16/2013	28832	CAFETERIA HELPER	N	BC02	01	T	N	0.50	16,614	0.50	16,944
EDN400/MD	10/16/2013	55712	CAFETERIA HELPER	N	BC02	01	T	B	0.50	16,614	0.50	16,944
EDN400/OC	10/16/2013	802510	PRGM SPCLT IV	N	SR22	13	P	A	1.00	40,895	1.00	47,400
EDN400/MD	10/16/2013	17460	CAFETERIA HELPER	N	BC02	01	P	A			0.50	16,944
EDN150/FA	10/16/2013	58971	EDUC ASST I	Y	SR08	03	P	A	0.75	20,609	0.75	9,995
EDN100/CB	10/16/2013	50395	PERSONNEL CLERK IV	N	SR11	03	P	A	1.00	26,633	1.00	14,969
EDN150/FA	10/18/2013	76170	SPEC ED TEACHER	Certificated	T02	05	P	A	1.00	43,611	1.00	43,759
EDN100/AA	10/21/2013	68860	ELEM TEACHER	Certificated	T02	05	T	A	1.00	47,969	1.00	45,072
EDN150/FA	10/21/2013	56699	EDUC ASST III	Y	SR12	03	T	A	1.00	28,544	1.00	25,030
EDN100/AA	10/21/2013	602750	ELEM TEACHER	Certificated	T03	05	T	A			1.00	47,259
EDN150/NB	10/21/2013	802451	EDUC ASST I	Y	SR08	03	T	N			1.00	13,327
EDN150/SA	10/21/2013	56365	SPEECH PATHOLOGIST II	Y	SR18	13	P	A	1.00	54,027	1.00	40,548
EDN100/AA	10/21/2013	61557	SECONDARY TEACHER	Certificated	T02	05	P	A	1.00	48,825	1.00	33,169
EDN150/FA	10/21/2013	63556	SPEC ED TEACHER	Certificated	T02	05	P	A	1.00	62,144	1.00	43,759
EDN100/AA	10/23/2013	801804	DP USER SUPPORT TECH I	N	SR13	03	T	A	1.00	33,010	1.00	16,211
EDN100/AA	10/24/2013	802728	EDUC ASST III	Y	SR12	03	T	A			1.00	25,030
EDN100/AA	10/24/2013	802987	SCHOOL CUSTODIAN II	N	BC02	01	T	A			0.50	16,944
EDN100/AA	10/24/2013	55398	OFFICE ASSISTANT III	N	SR08	03	T	A	1.00	26,110	1.00	13,327
EDN100/AA	10/24/2013	33150	SCHOOL SECURITY ATTENDANT	N	SR07	03	P	A	1.00	27,586	1.00	12,798
EDN100/AA	10/24/2013	27901	SCHOOL CUSTODIAN II	N	BC02	01	P	A	0.50	16,247	0.50	16,944
EDN100/AA	10/28/2013	29360	SCHOOL HEALTH AIDE	N	SR09	03	P	A	1.00	24,238	1.00	18,078
EDN150/YG	10/28/2013	801832	EDUC ASST I	Y	SR08	03	T	A	1.00	27,712	1.00	13,327
EDN100/AA	10/28/2013	74003	SECONDARY TEACHER	Certificated	T02	05	P	A	1.00	59,388	1.00	43,759

Department of Education
New Hires

Table 16

<u>Prog ID/Org</u>	<u>New Hire Effective Date</u>	<u>Position Number</u>	<u>Position Title</u>	<u>Exempt (Y/N)</u>	<u>SR Level</u>	<u>BU Code</u>	<u>T/P</u>	<u>MOF</u>	<u>Budgeted FTE</u>	<u>Budgeted Salary</u>	<u>Actual FTE</u>	<u>Actual Salary</u>
EDN150/FA	10/28/2013	601365	SPEC ED TEACHER	Certificated	T03	05	T	A			1.00	47,259
EDN150/YC	10/28/2013	58531	BEHAVIORAL HLTH SPLCT III	N	SR20	13	P	A	1.00	42,066	1.00	22,745
EDN100/AA	10/28/2013	67476	ELEM TEACHER	Certificated	T03	05	T	A	1.00	31,990	1.00	47,259
EDN400/MB	10/29/2013	801150	OFFICE ASSISTANT III	N	SR08	03	T	B			1.00	13,327
EDN150/SA	10/30/2013	50753	HUMAN SVCS PROF IV	N	SR22	13	P	A	1.00	54,744	1.00	47,400
EDN100/AA	10/30/2013	64873	SECONDARY TEACHER	Certificated	T02	05	P	A	1.00	49,378	1.00	43,759
EDN100/AA	10/31/2013	23581	SCHOOL CUSTODIAN II	N	BC02	01	P	A	1.00	32,494	1.00	33,888
EDN150/YG	10/31/2013	58040	OFFICE ASSISTANT III	N	SR08	03	T	A			1.00	13,327
EDN150/FA	11/1/2013	802715	EDUC ASST III	Y	SR12	03	T	A			0.50	12,515
EDN150/FA	11/1/2013	802755	EDUC ASST III	Y	SR12	03	T	A			0.75	18,773
EDN100/AA	11/1/2013	22405	SCHOOL CUSTODIAN II	N	BC02	01	P	A	0.50	16,247	0.50	16,944
EDN100/AA	11/1/2013	802883	SCHOOL CUSTODIAN II	N	BC02	01	T	A			0.50	16,944
EDN100/AA	11/1/2013	47089	SCHOOL CUSTODIAN II	N	BC02	01	P	A	0.50	16,247	0.50	16,944
EDN100/AA	11/1/2013	63294	SECONDARY TEACHER	Certificated	T02	05	P	A	1.00	57,657	1.00	33,169
EDN100/AA	11/1/2013	16361	SCHOOL CUSTODIAN II	N	BC02	01	P	A	0.50	16,247	0.50	16,944
EDN100/AA	11/1/2013	18832	SCHOOL CUSTODIAN II	N	BC02	01	P	A	1.00	32,494	1.00	17,593
EDN100/AA	11/1/2013	47009	SCHOOL CUSTODIAN II	N	BC02	01	P	A	0.50	16,247	0.50	16,944
EDN400/OD	11/1/2013	16394	SCHOOL CUSTODIAN II	N	BC02	01	P	A	1.00	34,759	1.00	33,888
EDN100/AA	11/1/2013	59777	LIBRARY ASSISTANT II	N	SR05	03	T	A			0.50	11,388
EDN150/FA	11/1/2013	56691	EDUC ASST I	Y	SR08	03	T	A	0.75	18,338	0.75	16,043
EDN150/SA	11/1/2013	30506	COMMUNICATION AIDE	Y	SR12	03	P	A	0.75	18,081	0.75	11,696
EDN100/AA	11/1/2013	4956	OFFICE ASSISTANT III	N	SR08	03	P	A	1.00	28,199	1.00	25,668
EDN150/FA	11/1/2013	58683	EDUC ASST III	Y	SR12	03	T	A	0.75	18,338	0.75	18,773
EDN100/AA	11/1/2013	802773	DP USER SUPPORT TECH II	N	SR15	03	T	A			1.00	17,528
EDN150/FA	11/1/2013	57140	EDUC ASST I	Y	SR08	03	T	A	1.00	24,450	1.00	21,390
EDN400/MD	11/1/2013	58703	CAFETERIA HELPER	N	BC02	01	T	B	0.50	16,614	0.50	16,944
EDN100/AA	11/1/2013	802937	SCHOOL HEALTH AIDE	N	SR09	03	T	A			0.50	6,934
EDN150/YG	11/1/2013	802159	EDUC ASST I	Y	SR08	03	T	A			1.00	13,327
EDN400/MD	11/1/2013	58692	CAFETERIA HELPER	N	BC02	01	T	N			0.50	16,944
EDN300/KD	11/1/2013	15713	AUDITOR V	N	SR24	13	P	A	1.00	51,881	1.00	55,488
EDN400/MD	11/1/2013	801053	FOOD SERVICES DRIVER	N	BC03	01	P	B			1.00	34,848
EDN100/AA	11/1/2013	14749	OFFICE ASSISTANT III	N	SR08	03	P	A	1.00	25,101	1.00	25,668
EDN150/FA	11/4/2013	601266	SPEC ED TCHR/PRE-SCHOOL	Certificated	T03	05	T	A			1.00	48,678
EDN100/AA	11/4/2013	61883	COUNSELOR	Certificated	T03	05	P	A	1.00	45,579	1.00	47,259
EDN100/DB	11/4/2013	600686	ELEM TEACHER	Certificated	T03	05	T	N			1.00	47,259
EDN100/DB	11/4/2013	79287	TEST DEV SPEC II	Certificated	E07	06	T	N			1.00	77,069
EDN100/AA	11/4/2013	64601	SECONDARY TEACHER	Certificated	T03	05	P	A	1.00	45,579	1.00	47,259
EDN100/AA	11/5/2013	56580	OFFICE ASSISTANT III	N	SR08	03	P	A	1.00	29,373	1.00	25,668
EDN400/MD	11/6/2013	12592	CAFETERIA HELPER	N	BC02	01	P	A			0.50	16,944
EDN150/FA	11/6/2013	57221	EDUC ASST I	Y	SR08	03	P	A	0.75	18,338	0.75	9,995
EDN150/SA	11/8/2013	30935	COMMUNICATION AIDE	Y	SR12	03	P	A	1.00	24,107	1.00	15,595
EDN400/OC	11/12/2013	10127	SECRETARY IV	N	SR18	03	P	A	1.00	34,112	1.00	46,176
EDN100/AA	11/12/2013	802691	EDUC ASST II	Y	SR10	03	T	A			0.50	11,565
EDN100/AA	11/12/2013	802904	SCHOOL CUSTODIAN II	N	BC02	01	T	A			0.50	16,944
EDN150/FA	11/12/2013	55388	EDUC ASST II	Y	SR10	03	P	A	1.00	27,479	1.00	23,130
EDN100/AA	11/12/2013	39008	OFFICE ASSISTANT III	N	SR08	03	P	A	1.00	25,101	1.00	25,668
EDN150/FA	11/12/2013	601472	GEN EDUC/ARTICLE VI TCHR	Certificated	T03	05	T	A			1.00	47,259

Department of Education
New Hires

Table 16

<u>Prog ID/Org</u>	<u>New Hire Effective Date</u>	<u>Position Number</u>	<u>Position Title</u>	<u>Exempt (Y/N)</u>	<u>SR Level</u>	<u>BU Code</u>	<u>T/P</u>	<u>MOF</u>	<u>Budgeted FTE</u>	<u>Budgeted Salary</u>	<u>Actual FTE</u>	<u>Actual Salary</u>
EDN150/NB	11/12/2013	57168	EDUC ASST III	Y	SR12	03	T	N			1.00	25,030
EDN150/FA	11/12/2013	601485	GEN EDUC/ARTICLE VI TCHR	Certificated	T02	05	T	A			1.00	43,759
EDN100/BS	11/12/2013	76087	ROTC INSTRUCTOR	Certificated	ROTC	05	P	A	1.00	67,881	1.00	38,084
EDN150/FA	11/13/2013	62156	SPEC ED TEACHER	Certificated	T03	05	P	A			1.00	48,678
EDN150/FA	11/13/2013	60855	SPEC ED TEACHER	Certificated	T02	05	P	A			1.00	45,072
EDN150/YC	11/13/2013	802537	DP USER SUPPORT TECH II	N	SR15	03	T	A			1.00	17,528
EDN150/FA	11/14/2013	65326	SPEC ED TCHR/PRE-SCHOOL	Certificated	T03	05	P	A	1.00	57,801	1.00	47,259
EDN150/FA	11/14/2013	600460	SPEC ED TEACHER	Certificated	T02	05	T	A			1.00	33,169
EDN150/FB	11/14/2013	72899F	SPEC ED TEACHER	Certificated	T02	05	P	A	1.00	44,268	1.00	38,476
EDN100/AA	11/15/2013	73601	SECONDARY TEACHER	Certificated	T02	05	P	A	1.00	57,706	1.00	43,759
EDN150/FA	11/18/2013	800558	EDUC ASST III	Y	SR12	03	T	A	1.00	24,450	1.00	25,030
EDN100/AA	11/18/2013	802993	EDUC ASST II	Y	SR10	03	T	A			0.75	17,348
EDN150/SA	11/18/2013	12065	SOCIAL WORKER IV	N	SR22	13	P	A	1.00	43,235	1.00	24,613
EDN100/AA	11/18/2013	118365	SCHOOL HEALTH AIDE	N	SR09	03	P	A	1.00	20,762	1.00	18,078
EDN100/AA	11/18/2013	802884	EDUC ASST II	Y	SR10	03	T	A			1.00	27,756
EDN100/AA	11/18/2013	801727	SCHOOL CUSTODIAN II	N	BC02	01	T	A			0.50	16,944
EDN100/AA	11/18/2013	71316	SECONDARY TEACHER	Certificated	T02	05	P	A	1.00	63,058	1.00	33,169
EDN400/MD	11/18/2013	9316	CAFETERIA HELPER	N	BC02	01	P	B			0.50	8,797
EDN400/MD	11/18/2013	802693	CAFETERIA HELPER	N	BC02	01	P	A			0.50	16,944
EDN400/MD	11/18/2013	802694	CAFETERIA HELPER	N	BC02	01	T	N			0.50	16,944
EDN100/AA	11/18/2013	74854	ELEM TEACHER	Certificated	T02	05	P	A	1.00	46,948	1.00	43,759
EDN100/AA	11/18/2013	802208	EDUC ASST II	Y	SR10	03	T	A	0.75	19,166	0.75	17,348
EDN150/YG	11/18/2013	801702	EDUC ASST I	Y	SR08	03	T	A			1.00	13,327
EDN100/AA	11/18/2013	802774	OFFICE ASSISTANT II	N	SR06	03	T	A			1.00	23,688
EDN150/FA	11/18/2013	44315	EDUC ASST III	Y	SR12	03	T	A	0.88	26,010	0.75	18,773
EDN150/FA	11/18/2013	57033	EDUC ASST III	Y	SR12	03	P	A	1.00	28,544	1.00	25,030
EDN100/AA	11/18/2013	45330	EDUC ASST II	Y	SR10	03	P	A	1.00	31,067	1.00	23,130
EDN500/WA	11/18/2013	800752	ACCOUNT CLERK III	N	SR11	03	T	W			1.00	28,836
EDN150/FA	11/18/2013	66291	GEN EDUC/ARTICLE VI TCHR	Certificated	T03	05	P	A			1.00	47,259
EDN150/SA	11/18/2013	30411	SPEECH PATHOLOGIST II	Y	SR18	13	P	A	1.00	61,990	1.00	21,049
EDN150/FA	11/19/2013	802594	EDUC ASST I	Y	SR08	03	T	A			1.00	21,390
EDN150/YC	11/19/2013	800467	SCHOOL PSYCHOLOGIST	Y	SR24	13	P	A	1.00	54,194	1.00	53,364
EDN150/FA	11/20/2013	55323	EDUC ASST III	Y	SR12	03	P	A	1.00	24,450	1.00	25,030
EDN150/YC	11/20/2013	59826	BEHAVIORAL HLTH SPCLT III	N	SR20	13	P	A	1.00	42,066	1.00	22,745
EDN400/MB	11/25/2013	801153	OFFICE ASSISTANT III	N	SR08	03	T	B			1.00	13,327
EDN150/FA	11/25/2013	802867	EDUC ASST I	Y	SR08	03	T	A			1.00	21,390
EDN100/AA	11/25/2013	16646	SCHOOL CUSTODIAN II	N	BC02	01	P	A	0.50	16,247	0.50	16,944
EDN150/FA	11/25/2013	601044	SPEC ED TCHR/PRE-SCHOOL	Certificated	T02	05	P	A	1.00	43,611	1.00	43,759
EDN100/AA	11/25/2013	16654	SCHOOL CUSTODIAN II	N	BC02	01	P	A	0.50	16,247	0.50	16,944
EDN150/FA	11/27/2013	802866	EDUC ASST II	Y	SR10	03	T	A			1.00	23,130
EDN100/AA	11/27/2013	60801	SECONDARY TEACHER	Certificated	T02	05	P	A	1.00	46,601	1.00	43,759
EDN200	7/5/2011	600998	PERSONNEL SPECIALIST II	Certificated	E07	06	T	V			1.00	77,069
EDN200	7/5/2011	600999	PERSONNEL SPECIALIST II	Certificated	E07	06	T	V			1.00	77,069
EDN200	7/11/2011	601798	INSTIT ANALYST II	Certificated	E07	06	T	V			1.00	86,133
EDN200	7/18/2011	600992	INSTIT ANALYST III	Certificated	E08	06	T	V			1.00	91,060
EDN100BJ	7/26/2011	73075	SECONDARY TEACHER	Certificated	T03	05	P	A	1.00	64,482	1.00	45,909
EDN100BJ	7/26/2011	73176	SECONDARY TEACHER	Certificated	T03	05	P	A	1.00	48,008	1.00	45,909

Department of Education
New Hires

Table 16

<u>Prog ID/Org</u>	<u>New Hire Effective Date</u>	<u>Position Number</u>	<u>Position Title</u>	<u>Exempt (Y/N)</u>	<u>SR Level</u>	<u>BU Code</u>	<u>T/P</u>	<u>MOF</u>	<u>Budgeted FTE</u>	<u>Budgeted Salary</u>	<u>Actual FTE</u>	<u>Actual Salary</u>
EDN100	7/26/2011	602322	ELEM TEACHER	Certificated	T03	05	T	V			1.00	45,909
EDN100BJ	7/26/2011	73102	SECONDARY TEACHER	Certificated	T02	05	T	A	1.00	59,617	1.00	42,509
EDN200	8/8/2011	600993	INSTIT ANALYST III	Certificated	E08	06	T	V			1.00	96,267
EDN200	9/1/2011	801822	PERSONNEL MGMT SPECIALIST IV	N	SR22	13	T	V			1.00	45,576
EDN200	11/15/2011	602261	DOE COMM SPEC II	Certificated	E07	06	T	V			1.00	86,133
EDN100BJ	11/28/2011	68095	SECONDARY TEACHER	Certificated	T02	05	P	A	1.00	74,688	1.00	42,509
EDN100	12/5/2011	602477	PRE-SCH TCHR	Certificated	T03	05	T	A			1.00	47,287
EDN100	12/12/2011	602476	PRE-SCH TCHR	Certificated	T03	05	T	A			1.00	45,909
EDN100EI	1/4/2012	602503	DIST OFF TCHR	Certificated	T02	05	T	A			1.00	42,509
EDN100BJ	1/4/2012	74261	SECONDARY TEACHER	Certificated	T03	05	P	A	1.00	68,351	1.00	45,909
EDN100	1/26/2012	600423	ELEM TEACHER	Certificated	T03	05	T	V			1.00	45,909
EDN100	4/10/2012	79889	VOC/TECH EDUC SPEC II	Certificated	E07	06	T	N			1.00	77,069
EDN200	4/16/2012	602536	INSTIT ANALYST II	Certificated	E07	06	T	V			1.00	77,069
EDN200	4/23/2012	600991	INSTIT ANALYST II	Certificated	E07	06	T	V			1.00	89,803
EDN100	5/14/2012	802422	EDUC ASST I	Y	SR08	03	T	A			1.00	13,327
EDN200	5/14/2012	802431	OFFICE ASSISTANT III	N	SR08	03	T	V			1.00	13,327
EDN200	7/16/2012	602056	DIST OFF TCHR	Certificated	T02	05	T	V			1.00	37,893
EDN100	7/30/2012	802481	OFFICE ASSISTANT III	N	SR08	03	T	T			1.00	13,327
EDN200	8/15/2012	79194	DATA FELLOW	Certificated	E07	06	T	V			1.00	87,340
EDN100	10/10/2012	59652	PRE AUDIT CLERK II	N	SR13	03	T	N			1.00	16,211
EDN100	10/10/2012	59653	PRE AUDIT CLERK II	N	SR13	03	T	N			1.00	16,211
EDN200	10/22/2012	603324	DISTRICT EDUC SPEC II	Certificated	E07	06	T	A			1.00	77,069
EDN200	12/3/2012	802680	ACCOUNT CLERK III	N	SR11	03	T	V			1.00	28,836
EDN100	1/22/2013	802419	EDUC ASST I	Y	SR08	03	T	A			1.00	21,390
EDN100	2/12/2013	47824	ACCOUNTANT IV	N	SR22	13	T	N			1.00	23,663
EDN100	3/11/2013	802481	OFFICE ASSISTANT III	N	SR08	03	T	T			1.00	13,327
EDN100	4/2/2013	802420	EDUC ASST I	Y	SR08	03	T	A			1.00	13,327
EDN200	5/6/2013	801825	PERSONNEL CLERK V	N	SR13	03	T	V			1.00	16,211
EDN200	8/5/2013	604584	COMPLEX AREA TEACHER	Certificated	T02	05	T	A			1.00	33,169
EDN100	8/22/2013	802421	EDUC ASST I	Y	SR08	03	T	A			1.00	13,327
EDN200	9/4/2013	602056	SPECIAL SCH TEACHER	Certificated	T02	05	T	V			1.00	38,476
EDN200	11/1/2013	604541	COMPLEX AREA TEACHER	Certificated	T07	05	T	A			1.00	58,042
EDN200	11/18/2013	601798	INSTIT ANALYST II	Certificated	E07	06	T	V			1.00	89,803

Department of Education
Unappropriated Positions as of June 28, 2013

Table 17

<u>Prog ID</u>	<u>Date Established</u>	<u>Legal Authority</u>	<u>Position Number</u>	<u>Position Title</u>	<u>Exempt (Y/N)</u>	<u>SR Level</u>	<u>BU Code</u>	<u>T/P</u>	<u>MOF</u>	<u>FTE</u>	<u>Annual Salary</u>	<u>Filled (Y/N)</u>	<u>Occupied by 89 Day Hire (Y/N)</u>
EDN100	3/1/2012	302A-1116, HRS	14190	Secretary II	N	SR14	03	T	N	1.00	\$33,311	Y	N
EDN100	7/1/2000	302A-1116, HRS	23101	Account Clerk III	N	SR11	03	T	N	1.00	\$28,836	N	N
EDN100	9/1/2000	302A-1116, HRS	23369	Educ Asst III	Y	SR12	03	T	N	1.00	\$28,534	N	N
EDN100	9/1/2000	302A-1116, HRS	32410	Educ Asst III	Y	SR12	03	T	N	0.50	\$16,315	Y	N
EDN100	9/1/2000	302A-1116, HRS	35220	Educ Asst III	Y	SR12	03	T	N	1.00	\$28,981	Y	N
EDN100	3/1/2012	302A-1116, HRS	41723	Account Clerk III	N	SR11	03	T	N	1.00	\$34,690	Y	N
EDN100	7/1/2000	302A-1116, HRS	46593	Television Production Crew Chf	N	SR17	04	T	T	1.00	\$36,070	Y	N
EDN100	7/1/2000	302A-1116, HRS	46594	Television Production Crew Chf	N	SR17	04	T	T	1.00	\$43,867	Y	N
EDN100	7/1/2000	302A-1116, HRS	47750	Television Prod Svcs Supvr	N	SR23	04	T	T	1.00	\$49,339	Y	N
EDN100	7/1/2010	302A-1116, HRS	47824	Accountant IV	N	SR22	13	T	N	1.00	\$43,297	Y	Y
EDN100	7/1/2012	302A-1116, HRS	50850	Educ Asst III	Y	SR12	03	T	N	0.75	\$20,024	Y	Y
EDN100	7/1/2012	302A-1116, HRS	50851	Educ Asst III	Y	SR12	03	T	N	1.00	\$30,036	Y	N
EDN100	7/1/2000	302A-1116, HRS	52011	Television Production Tech	N	SR13	03	T	T	1.00	\$29,651	Y	N
EDN100	7/1/2000	302A-1116, HRS	52511	Office Assistant III	N	SR08	03	T	N	1.00	\$29,651	Y	N
EDN100	9/1/2000	302A-1116, HRS	54979	Educ Asst III	Y	SR12	03	T	N	1.00	\$33,787	Y	N
EDN100	7/1/2012	302A-1116, HRS	56078	Educ Asst III	Y	SR12	03	T	N	1.00	\$30,036	Y	N
EDN100	7/1/2003	302A-1116, HRS	56079	Secretary II	N	SR14	03	T	N	1.00	\$32,068	Y	N
EDN100	7/1/2010	302A-1116, HRS	56388	Administrative Services Asst	N	SR22	13	T	N	1.00	\$48,746	Y	N
EDN100	7/1/2010	302A-1116, HRS	56390	Personnel Clerk V	N	SR13	03	T	N	1.00	\$33,311	Y	N
EDN100	7/1/2010	302A-1116, HRS	56391	Office Assistant V	N	SR12	03	T	N	1.00	\$28,534	N	N
EDN100	7/1/2010	302A-1116, HRS	58248	Pre Audit Clerk II	N	SR13	03	T	N	1.00	\$29,651	N	N
EDN100	11/6/2002	302A-1116, HRS	58547	Account Clerk III	N	SR11	03	T	N	1.00	\$27,394	Y	N
EDN100	12/24/2002	302A-1116, HRS	58605	Secretary I	N	SR12	03	T	A	1.00	\$30,036	Y	N
EDN100	9/10/2004	302A-1116, HRS	59037	Accountant IV	N	SR22	13	T	N	1.00	\$43,297	N	N
EDN100	4/1/2010	302A-1116, HRS	59112	Account Clerk II	N	SR08	03	T	U	1.00	\$13,184	Y	N
EDN100	7/2/2004	302A-1116, HRS	59583	Office Assistant III	N	SR08	03	T	N	1.00	\$24,385	Y	Y
EDN100	8/26/2005	302A-1116, HRS	59615	Television Production Tech	N	SR13	03	T	T	1.00	\$30,803	Y	N
EDN100	6/14/2010	302A-1116, HRS	59640	Personnel Mgmt Specialist IV	N	SR22	13	T	N	1.00	\$43,297	N	N
EDN100	11/17/2005	302A-1116, HRS	59650	Pre Audit Clerk II	N	SR13	03	T	N	1.00	\$29,651	N	N
EDN100	11/17/2005	302A-1116, HRS	59652	Pre Audit Clerk II	N	SR13	03	T	N	1.00	\$29,651	Y	Y
EDN100	11/17/2005	302A-1116, HRS	59653	Pre Audit Clerk II	N	SR13	03	T	N	1.00	\$29,651	Y	N
EDN100	11/17/2005	302A-1116, HRS	59656	Pre Audit Clerk I	N	SR11	03	T	N	1.00	\$27,394	N	N
EDN100	7/1/2010	302A-1116, HRS	59675	Legal Assistant III	N	SR20	13	T	T	1.00	\$41,040	N	N
EDN100	1/6/2006	302A-1116, HRS	59690	Personnel Clerk IV	N	SR11	03	T	P	1.00	\$29,651	Y	N
EDN100	3/30/2006	302A-1116, HRS	59703	Personnel Mgmt Specialist IV	N	SR22	13	T	N	1.00	\$48,746	Y	N
EDN100	7/20/2006	302A-1116, HRS	59815	Personnel Clerk IV	N	SR11	03	T	P	1.00	\$27,394	Y	Y
EDN100	10/13/2009	302A-1116, HRS	59992	Prgm Spclt V	N	SR24	13	T	W	1.00	\$48,746	N	N
EDN100	8/5/2007	302A-1116, HRS	59993	Office Assistant III	N	SR08	03	T	N	1.00	\$24,385	N	N
EDN100	7/27/2010	302A-1116, HRS	61568	Elem Teacher	Certificated	T01	05	T	N	1.00	\$43,496	Y	N
EDN100	7/28/2009	302A-1116, HRS	61699	Dist Off Tchr	Certificated	T02	05	T	A	1.00	\$55,916	N	N
EDN100	11/2/2009	302A-1116, HRS	62589	Secondary Teacher	Certificated	T01	05	T	T	0.50	\$27,958	Y	N
EDN100	7/26/2011	302A-1116, HRS	62690	Elem Teacher	Certificated	T01	05	T	N	1.00	\$40,999	Y	N
EDN100	7/26/2011	302A-1116, HRS	63007	Secondary Teacher	Certificated	T01	05	T	N	0.50	\$24,427	Y	N
EDN100	7/27/2010	302A-1116, HRS	63121	Secondary Teacher	Certificated	T01	05	T	N	0.50	\$20,500	Y	N
EDN100	7/26/2011	302A-1116, HRS	63183	Secondary Teacher	Certificated	T01	05	T	N	1.00	\$44,278	Y	N

Department of Education
Unappropriated Positions as of June 28, 2013

Table 17

<u>Prog ID</u>	<u>Date Established</u>	<u>Legal Authority</u>	<u>Position Number</u>	<u>Position Title</u>	<u>Exempt (Y/N)</u>	<u>SR Level</u>	<u>BU Code</u>	<u>T/P</u>	<u>MOF</u>	<u>FTE</u>	<u>Annual Salary</u>	<u>Filled (Y/N)</u>	<u>Occupied by 89 Day Hire (Y/N)</u>
EDN100	11/1/2012	302A-1116, HRS	63258	Secondary Teacher	Certificated	T01	05	T	N	0.50	\$27,958	Y	N
EDN100	7/28/2009	302A-1116, HRS	63409	Dist Off Tchr	Certificated	T02	05	T	A	1.00	\$55,916	Y	N
EDN100	7/26/2011	302A-1116, HRS	63730	Elem Teacher	Certificated	T01	05	T	N	1.00	\$40,999	Y	N
EDN100	7/26/2011	302A-1116, HRS	64273	Elem Teacher	Certificated	T01	05	T	N	1.00	\$63,094	Y	N
EDN100	11/2/2009	302A-1116, HRS	64549	Secondary Teacher	Certificated	T01	05	T	T	0.50	\$27,958	Y	N
EDN100	7/26/2011	302A-1116, HRS	64687	Elem Teacher	Certificated	T01	05	T	N	1.00	\$40,999	Y	N
EDN100	7/27/2010	302A-1116, HRS	66098	Elem Teacher	Certificated	T01	05	T	N	1.00	\$40,999	Y	N
EDN100	7/27/2010	302A-1116, HRS	66179	Secondary Teacher	Certificated	T01	05	T	T	0.50	\$27,958	Y	N
EDN100	7/27/2010	302A-1116, HRS	66434	Secondary Teacher	Certificated	T01	05	T	N	0.50	\$29,735	Y	N
EDN100	7/28/2009	302A-1116, HRS	67139	Dist Off Tchr	Certificated	T02	05	T	A	1.00	\$55,916	Y	N
EDN100	7/24/2012	302A-1116, HRS	67540	Secondary Teacher	Certificated	T01	05	T	N	0.50	\$27,958	Y	N
EDN100	7/26/2011	302A-1116, HRS	68334	Elem Teacher	Certificated	T01	05	T	N	1.00	\$46,975	Y	N
EDN100	7/28/2009	302A-1116, HRS	68640	State Office Teacher	Certificated	T05	05	T	A	1.00	\$55,916	Y	N
EDN100	7/27/2010	302A-1116, HRS	68767	Elem Teacher	Certificated	T01	05	T	N	1.00	\$40,999	Y	N
EDN100	7/26/2011	302A-1116, HRS	68782	Elem Teacher	Certificated	T01	05	T	N	1.00	\$60,833	Y	N
EDN100	7/28/2009	302A-1116, HRS	68862	State Office Teacher	Certificated	T05	05	T	A	1.00	\$55,916	Y	N
EDN100	7/28/2009	302A-1116, HRS	69415	Secondary Teacher	Certificated	T01	05	T	N	1.00	\$44,278	Y	N
EDN100	7/24/2012	302A-1116, HRS	69923	Secondary Teacher	Certificated	T01	05	T	N	0.50	\$27,958	Y	N
EDN100	7/27/2010	302A-1116, HRS	71022	Elem Teacher	Certificated	T01	05	T	N	1.00	\$51,829	Y	N
EDN100	7/28/2009	302A-1116, HRS	71562	Dist Off Tchr	Certificated	T02	05	T	A	1.00	\$55,916	Y	N
EDN100	7/24/2012	302A-1116, HRS	71962	Secondary Teacher	Certificated	T01	05	T	N	0.50	\$27,958	Y	N
EDN100	7/26/2011	302A-1116, HRS	72035	Secondary Teacher	Certificated	T01	05	T	N	1.00	\$46,049	Y	N
EDN100	7/24/2012	302A-1116, HRS	72329	Elem Teacher	Certificated	T01	05	T	N	0.50	\$29,451	Y	N
EDN100	7/28/2009	302A-1116, HRS	72513	Dist Off Tchr	Certificated	T02	05	T	A	1.00	\$55,916	Y	N
EDN100	7/28/2009	302A-1116, HRS	72740	Dist Off Tchr	Certificated	T02	05	T	A	1.00	\$55,916	Y	N
EDN100	7/26/2011	302A-1116, HRS	74596	Elem Teacher	Certificated	T01	05	T	N	1.00	\$40,999	Y	N
EDN100	7/28/2009	302A-1116, HRS	74906	State Office Teacher	Certificated	T05	05	T	T	1.00	\$50,808	Y	N
EDN100	7/1/2009	302A-1116, HRS	74927	Educational Spec II	Y	E07	06	T	A	1.00	\$77,069	N	N
EDN100	7/28/2009	302A-1116, HRS	75030	Dist Off Tchr	Certificated	T02	05	T	A	1.00	\$55,916	Y	N
EDN100	7/28/2009	302A-1116, HRS	75092	Dist Off Tchr	Certificated	T02	05	T	T	1.00	\$55,916	N	N
EDN100	7/28/2009	302A-1116, HRS	75093	Dist Off Tchr	Certificated	T02	05	T	T	1.00	\$55,916	Y	N
EDN100	7/28/2009	302A-1116, HRS	75094	Dist Off Tchr	Certificated	T02	05	T	T	1.00	\$55,916	Y	N
EDN100	7/28/2009	302A-1116, HRS	75095	Dist Off Tchr	Certificated	T02	05	T	T	1.00	\$55,916	N	N
EDN100	7/28/2009	302A-1116, HRS	75096	Dist Off Tchr	Certificated	T02	05	T	T	1.00	\$55,916	Y	N
EDN100	7/1/2009	302A-1116, HRS	75097	12-Mo Dist Off Tchr	Certificated	T02	05	T	N	1.00	\$56,370	Y	N
EDN100	7/28/2009	302A-1116, HRS	75099	State Office Teacher	Certificated	T05	05	T	T	1.00	\$55,916	N	N
EDN100	7/28/2009	302A-1116, HRS	75103	State Office Teacher	Certificated	T05	05	T	T	1.00	\$55,916	Y	N
EDN100	7/28/2009	302A-1116, HRS	75104	State Office Teacher	Certificated	T05	05	T	T	1.00	\$55,916	N	N
EDN100	7/1/2009	302A-1116, HRS	75419	Educational Spec II	Y	E07	06	T	N	1.00	\$76,333	Y	N
EDN100	7/1/2010	302A-1116, HRS	75888	Civ Rights Compl Spec II	Certificated	E07	06	T	T	1.00	\$77,069	N	N
EDN100	7/28/2009	302A-1116, HRS	76113	12-Mo State Off Tchr	Certificated	T02	05	T	T	1.00	\$55,916	Y	N
EDN100	4/19/2008	302A-1116, HRS	76187	Prog Supp & Dev Spec I	Certificated	E06	06	T	W	1.00	\$71,206	Y	N
EDN100	7/28/2009	302A-1116, HRS	79145	Dist Off Tchr	Certificated	T02	05	T	N	1.00	\$75,211	N	N
EDN100	11/10/2009	302A-1116, HRS	79147	Dist Off Tchr	Certificated	T02	05	T	N	0.50	\$31,521	Y	N
EDN100	7/28/2009	302A-1116, HRS	79183	Secondary Teacher	Certificated	T01	05	T	N	1.00	\$52,332	Y	N

Department of Education
Unappropriated Positions as of June 28, 2013

Table 17

<u>Prog ID</u>	<u>Date Established</u>	<u>Legal Authority</u>	<u>Position Number</u>	<u>Position Title</u>	<u>Exempt (Y/N)</u>	<u>SR Level</u>	<u>BU Code</u>	<u>T/P</u>	<u>MOF</u>	<u>FTE</u>	<u>Annual Salary</u>	<u>Filled (Y/N)</u>	<u>Occupied by 89 Day Hire (Y/N)</u>
EDN100	7/28/2009	302A-1116, HRS	79184	Secondary Teacher	Certificated	T01	05	T	N	1.00	\$40,999	N	N
EDN100	7/28/2009	302A-1116, HRS	79185	Secondary Teacher	Certificated	T01	05	T	N	1.00	\$48,215	Y	N
EDN100	7/28/2009	302A-1116, HRS	79188	Elem Teacher	Certificated	T01	05	T	N	1.00	\$40,999	Y	N
EDN100	7/1/2009	302A-1116, HRS	79191	Personnel Specialist III	Certificated	E08	06	T	N	1.00	\$76,333	N	N
EDN100	7/1/2009	302A-1116, HRS	79195	Evaluation Spec II	Certificated	E07	06	T	N	1.00	\$88,945	N	N
EDN100	7/1/2009	302A-1116, HRS	79196	Evaluation Spec II	Certificated	E07	06	T	N	1.00	\$76,333	Y	N
EDN100	7/1/2009	302A-1116, HRS	79197	Evaluation Spec II	Certificated	E07	06	T	N	1.00	\$90,190	Y	N
EDN100	7/1/2009	302A-1116, HRS	79198	Evaluation Spec II	Certificated	E07	06	T	N	1.00	\$73,216	Y	N
EDN100	7/1/2007	302A-1116, HRS	79206	Spec Prog Mgmt Spec II	Certificated	E07	06	T	N	1.00	\$94,031	Y	N
EDN100	7/1/2009	302A-1116, HRS	79208	12-Mo State Off Tchr	Certificated	T02	05	T	N	1.00	\$80,256	Y	N
EDN100	7/1/2009	302A-1116, HRS	79211	Educational Spec II	Y	E07	06	T	N	1.00	\$74,239	Y	N
EDN100	7/1/2009	302A-1116, HRS	79212	District Educ Spec II	Certificated	E07	06	T	N	1.00	\$103,644	Y	N
EDN100	12/6/2008	302A-1116, HRS	79213	District Educ Spec II	Certificated	E07	06	T	N	1.00	\$73,216	N	N
EDN100	12/23/2008	302A-1116, HRS	79214	Complex Academic Officer	Certificated	E07	06	T	N	1.00	\$73,216	Y	N
EDN100	12/23/2008	302A-1116, HRS	79215	Complex Academic Officer	Certificated	E07	06	T	N	1.00	\$79,583	Y	N
EDN100	4/21/2009	302A-1116, HRS	79216	Special Projects Director	Certificated	E10	06	T	W	1.00	\$88,945	Y	N
EDN100	5/12/2009	302A-1116, HRS	79217	Educational Spec II	Y	E07	06	T	N	1.00	\$74,239	N	N
EDN100	5/12/2009	302A-1116, HRS	79218	Educational Spec II	Y	E07	06	T	N	1.00	\$73,216	N	N
EDN100	7/1/2009	302A-1116, HRS	79220	District Educ Spec II	Certificated	E07	06	T	N	1.00	\$103,644	Y	N
EDN100	7/10/2009	302A-1116, HRS	79222	Educational Spec II	Y	E07	06	T	N	1.00	\$73,216	N	N
EDN100	7/28/2009	302A-1116, HRS	79224	Dist Off Tchr	Certificated	T02	05	T	N	1.00	\$64,933	Y	N
EDN100	7/28/2009	302A-1116, HRS	79225	Elem Teacher	Certificated	T01	05	T	N	1.00	\$48,215	Y	N
EDN100	7/28/2009	302A-1116, HRS	79229	Secondary Teacher	Certificated	T01	05	T	N	1.00	\$44,278	Y	N
EDN100	7/28/2009	302A-1116, HRS	79235	Elem Teacher	Certificated	T01	05	T	N	1.00	\$59,297	N	N
EDN100	7/28/2009	302A-1116, HRS	79247	Elem Teacher	Certificated	T01	05	T	N	1.00	\$59,422	Y	N
EDN100	7/28/2009	302A-1116, HRS	79254	Secondary Teacher	Certificated	T01	05	T	N	1.00	\$40,999	Y	N
EDN100	7/28/2009	302A-1116, HRS	79258	Elem Teacher	Certificated	T01	05	T	N	1.00	\$44,278	Y	N
EDN100	9/1/2012	302A-1116, HRS	79264	Educational Spec II	Y	E07	06	T	N	1.00	\$77,069	Y	N
EDN100	7/1/2009	302A-1116, HRS	79269	Complex Academic Officer	Certificated	E07	06	T	N	1.00	\$73,216	N	N
EDN100	7/28/2009	302A-1116, HRS	79270	Title I Linker Teacher	Certificated	T02	05	T	N	1.00	\$76,362	Y	N
EDN100	7/28/2009	302A-1116, HRS	79271	Title I Linker Teacher	Certificated	T02	05	T	N	1.00	\$66,880	Y	N
EDN100	7/28/2009	302A-1116, HRS	79272	Title I Linker Teacher	Certificated	T02	05	T	N	1.00	\$56,010	Y	N
EDN100	7/28/2009	302A-1116, HRS	79273	Title I Linker Teacher	Certificated	T02	05	T	N	1.00	\$61,205	Y	N
EDN100	7/28/2009	302A-1116, HRS	79274	Title I Linker Teacher	Certificated	T02	05	T	N	1.00	\$59,422	Y	N
EDN100	7/28/2009	302A-1116, HRS	79275	Title I Linker Teacher	Certificated	T02	05	T	N	1.00	\$53,902	Y	N
EDN100	7/28/2009	302A-1116, HRS	79276	Title I Linker Teacher	Certificated	T02	05	T	N	1.00	\$49,837	Y	N
EDN100	7/1/2009	302A-1116, HRS	79287	Test Dev Spec II	Certificated	E07	06	T	N	1.00	\$73,216	N	N
EDN100	7/1/2009	302A-1116, HRS	79288	Educational Spec II	Y	E07	06	T	N	1.00	\$73,216	Y	N
EDN100	7/1/2009	302A-1116, HRS	79289	Educational Spec II	Y	E07	06	T	N	1.00	\$74,239	Y	N
EDN100	7/28/2009	302A-1116, HRS	79291	Elem Teacher	Certificated	T01	05	T	N	0.50	\$23,488	Y	N
EDN100	7/1/2009	302A-1116, HRS	79303	Personnel Specialist II	Certificated	E07	06	T	N	1.00	\$73,216	N	N
EDN100	7/1/2009	302A-1116, HRS	79304	Personnel Specialist II	Certificated	E07	06	T	N	1.00	\$73,216	N	N
EDN100	10/1/2003	302A-1116, HRS	79317	State Office Teacher	Certificated	T05	05	T	U	1.00	\$68,224	Y	N
EDN100	3/1/2011	302A-1116, HRS	79320	State Office Teacher	Certificated	T05	05	T	N	1.00	\$40,999	N	N
EDN100	7/1/2012	302A-1116, HRS	79329	Educational Spec II	Y	E07	06	T	N	1.00	\$73,216	N	N

Department of Education
Unappropriated Positions as of June 28, 2013

Table 17

<u>Prog ID</u>	<u>Date Established</u>	<u>Legal Authority</u>	<u>Position Number</u>	<u>Position Title</u>	<u>Exempt (Y/N)</u>	<u>SR Level</u>	<u>BU Code</u>	<u>T/P</u>	<u>MOF</u>	<u>FTE</u>	<u>Annual Salary</u>	<u>Filled (Y/N)</u>	<u>Occupied by 89 Day Hire (Y/N)</u>
EDN100	7/1/2009	302A-1116, HRS	79333	Personnel Specialist II	Certificated	E07	06	T	N	1.00	\$73,216	N	N
EDN100	7/28/2009	302A-1116, HRS	79344	Secondary Teacher	Certificated	T01	05	T	N	1.00	\$44,278	Y	N
EDN100	7/28/2009	302A-1116, HRS	79407	Dist Off Tchr	Certificated	T02	05	T	N	1.00	\$59,422	Y	N
EDN100	7/28/2009	302A-1116, HRS	79412	Secondary Teacher	Certificated	T01	05	T	N	1.00	\$65,926	Y	N
EDN100	7/28/2009	302A-1116, HRS	79413	Elem Teacher	Certificated	T01	05	T	N	1.00	\$44,278	Y	N
EDN100	7/28/2009	302A-1116, HRS	79419	Elem Teacher	Certificated	T01	05	T	N	1.00	\$50,808	Y	N
EDN100	7/28/2009	302A-1116, HRS	79420	Secondary Teacher	Certificated	T01	05	T	N	1.00	\$40,999	Y	N
EDN100	7/28/2009	302A-1116, HRS	79426	Dist Off Tchr	Certificated	T02	05	T	N	1.00	\$65,869	Y	N
EDN100	7/28/2009	302A-1116, HRS	79427	Dist Off Tchr	Certificated	T02	05	T	N	1.00	\$57,453	Y	N
EDN100	7/28/2009	302A-1116, HRS	79428	Dist Off Tchr	Certificated	T02	05	T	N	1.00	\$57,692	Y	N
EDN100	7/28/2009	302A-1116, HRS	79432	Dist Off Tchr	Certificated	T02	05	T	N	1.00	\$57,692	Y	N
EDN100	7/28/2009	302A-1116, HRS	79436	Elem Teacher	Certificated	T01	05	T	N	1.00	\$48,215	Y	N
EDN100	1/5/2010	302A-1116, HRS	79437	Dist Off Tchr	Certificated	T02	05	T	N	1.00	\$56,010	N	N
EDN100	1/5/2010	302A-1116, HRS	79438	Dist Off Tchr	Certificated	T02	05	T	N	1.00	\$48,854	Y	N
EDN100	7/28/2009	302A-1116, HRS	79439	Dist Off Tchr	Certificated	T02	05	T	N	1.00	\$66,880	Y	N
EDN100	7/28/2009	302A-1116, HRS	79440	Dist Off Tchr	Certificated	T02	05	T	N	1.00	\$64,933	Y	N
EDN100	7/28/2009	302A-1116, HRS	79441	Dist Off Tchr	Certificated	T02	05	T	N	1.00	\$57,740	Y	N
EDN100	7/28/2009	302A-1116, HRS	79465	Dist Off Tchr	Certificated	T02	05	T	N	1.00	\$48,854	Y	N
EDN100	7/28/2009	302A-1116, HRS	79467	Dist Off Tchr	Certificated	T02	05	T	N	1.00	\$48,384	Y	N
EDN100	7/28/2009	302A-1116, HRS	79480	Elem Teacher	Certificated	T01	05	T	N	1.00	\$59,422	Y	N
EDN100	7/28/2009	302A-1116, HRS	79489	Title I Linker Teacher	Certificated	T02	05	T	N	1.00	\$50,319	Y	N
EDN100	7/28/2009	302A-1116, HRS	79491	State Office Teacher	Certificated	T05	05	T	T	1.00	\$40,999	N	N
EDN100	7/28/2009	302A-1116, HRS	79492	State Office Teacher	Certificated	T05	05	T	T	1.00	\$40,999	N	N
EDN100	7/1/2010	302A-1116, HRS	79497	Educational Spec II	Y	E07	06	T	N	1.00	\$77,069	Y	N
EDN100	7/28/2009	302A-1116, HRS	79509	Dist Off Tchr	Certificated	T02	05	T	N	1.00	\$56,059	Y	N
EDN100	7/28/2009	302A-1116, HRS	79519	Elem Teacher	Certificated	T01	05	T	N	1.00	\$44,503	Y	N
EDN100	7/28/2009	302A-1116, HRS	79525	Elem Teacher	Certificated	T01	05	T	N	1.00	\$44,278	Y	N
EDN100	7/28/2009	302A-1116, HRS	79526	Elem Teacher	Certificated	T01	05	T	N	1.00	\$43,496	Y	N
EDN100	7/28/2009	302A-1116, HRS	79529	Elem Teacher	Certificated	T01	05	T	N	1.00	\$44,278	Y	N
EDN100	2/1/2011	302A-1116, HRS	79530	12-Mo Secondary Teacher	Certificated	T02	05	T	N	1.00	\$55,916	Y	N
EDN100	7/1/2010	302A-1116, HRS	79531	12-Mo State Off Tchr	Certificated	T02	05	T	N	1.00	\$55,916	N	N
EDN100	7/28/2009	302A-1116, HRS	79547	Elem Teacher	Certificated	T01	05	T	N	1.00	\$40,999	Y	N
EDN100	7/28/2009	302A-1116, HRS	79552	Secondary Teacher	Certificated	T01	05	T	N	1.00	\$45,607	Y	N
EDN100	7/28/2009	302A-1116, HRS	79564	Dist Off Tchr	Certificated	T02	05	T	N	1.00	\$76,362	Y	N
EDN100	7/28/2009	302A-1116, HRS	79567	Elem Teacher	Certificated	T01	05	T	N	1.00	\$40,999	Y	N
EDN100	7/28/2009	302A-1116, HRS	79569	Elem Teacher	Certificated	T01	05	T	N	1.00	\$48,215	Y	N
EDN100	7/28/2009	302A-1116, HRS	79570	Secondary Teacher	Certificated	T01	05	T	N	1.00	\$48,854	Y	N
EDN100	7/28/2009	302A-1116, HRS	79573	Elem Teacher	Certificated	T01	05	T	N	1.00	\$67,846	Y	N
EDN100	3/1/2012	302A-1116, HRS	79574	State Office Teacher	Certificated	T05	05	T	N	1.00	\$40,999	N	N
EDN100	7/28/2009	302A-1116, HRS	79576	Dist Off Tchr	Certificated	T02	05	T	N	1.00	\$57,692	Y	N
EDN100	7/28/2009	302A-1116, HRS	79583	Elem Teacher	Certificated	T01	05	T	N	0.50	\$24,931	Y	N
EDN100	7/28/2009	302A-1116, HRS	79585	Secondary Teacher	Certificated	T01	05	T	N	1.00	\$52,072	Y	N
EDN100	7/28/2009	302A-1116, HRS	79589	Elem Teacher	Certificated	T01	05	T	N	1.00	\$64,664	Y	N
EDN100	7/28/2009	302A-1116, HRS	79599	Elem Teacher	Certificated	T01	05	T	N	1.00	\$40,999	Y	N
EDN100	7/28/2009	302A-1116, HRS	79601	Elem Teacher	Certificated	T01	05	T	N	1.00	\$40,999	Y	N

Department of Education
Unappropriated Positions as of June 28, 2013

Table 17

<u>Prog ID</u>	<u>Date Established</u>	<u>Legal Authority</u>	<u>Position Number</u>	<u>Position Title</u>	<u>Exempt (Y/N)</u>	<u>SR Level</u>	<u>BU Code</u>	<u>T/P</u>	<u>MOF</u>	<u>FTE</u>	<u>Annual Salary</u>	<u>Filled (Y/N)</u>	<u>Occupied by 89 Day Hire (Y/N)</u>
EDN100	7/28/2009	302A-1116, HRS	79605	Elem Teacher	Certificated	T01	05	T	N	1.00	\$44,278	Y	N
EDN100	7/28/2009	302A-1116, HRS	79609	Secondary Teacher	Certificated	T01	05	T	N	1.00	\$44,278	Y	N
EDN100	7/28/2009	302A-1116, HRS	79611	Elem Teacher	Certificated	T01	05	T	N	1.00	\$49,464	Y	N
EDN100	7/28/2009	302A-1116, HRS	79614	Elem Teacher	Certificated	T01	05	T	N	1.00	\$42,248	Y	N
EDN100	7/28/2009	302A-1116, HRS	79626	Secondary Teacher	Certificated	T01	05	T	N	1.00	\$44,278	Y	N
EDN100	7/28/2009	302A-1116, HRS	79634	Elem Teacher	Certificated	T01	05	T	N	1.00	\$40,999	Y	N
EDN100	7/28/2009	302A-1116, HRS	79635	Elem Teacher	Certificated	T01	05	T	N	1.00	\$40,999	Y	N
EDN100	7/28/2009	302A-1116, HRS	79636	Elem Teacher	Certificated	T01	05	T	N	1.00	\$40,999	Y	N
EDN100	7/28/2009	302A-1116, HRS	79640	Secondary Teacher	Certificated	T01	05	T	N	1.00	\$50,808	Y	N
EDN100	7/28/2009	302A-1116, HRS	79648	Elem Teacher	Certificated	T01	05	T	N	1.00	\$40,999	Y	N
EDN100	7/28/2009	302A-1116, HRS	79654	Secondary Teacher	Certificated	T01	05	T	N	1.00	\$48,215	Y	N
EDN100	7/28/2009	302A-1116, HRS	79661	Dist Off Tchr	Certificated	T02	05	T	N	1.00	\$56,059	Y	N
EDN100	7/28/2009	302A-1116, HRS	79662	Secondary Teacher	Certificated	T01	05	T	N	1.00	\$42,229	Y	N
EDN100	7/28/2009	302A-1116, HRS	79670	Dist Off Tchr	Certificated	T02	05	T	N	1.00	\$46,049	Y	N
EDN100	7/28/2009	302A-1116, HRS	79674	Elem Teacher	Certificated	T01	05	T	N	1.00	\$51,829	Y	N
EDN100	7/28/2009	302A-1116, HRS	79682	Secondary Teacher	Certificated	T01	05	T	N	1.00	\$45,607	Y	N
EDN100	7/28/2009	302A-1116, HRS	79695	Secondary Teacher	Certificated	T01	05	T	N	1.00	\$48,215	Y	N
EDN100	7/28/2009	302A-1116, HRS	79698	Secondary Teacher	Certificated	T01	05	T	N	1.00	\$44,278	Y	N
EDN100	7/28/2009	302A-1116, HRS	79700	Elem Teacher	Certificated	T01	05	T	N	1.00	\$48,854	Y	N
EDN100	7/28/2009	302A-1116, HRS	79701	Elem Teacher	Certificated	T01	05	T	N	1.00	\$44,278	Y	N
EDN100	7/28/2009	302A-1116, HRS	79702	Secondary Teacher	Certificated	T01	05	T	N	1.00	\$40,999	Y	N
EDN100	7/28/2009	302A-1116, HRS	79705	Elem Teacher	Certificated	T01	05	T	N	1.00	\$46,975	Y	N
EDN100	7/28/2009	302A-1116, HRS	79710	Secondary Teacher	Certificated	T01	05	T	N	1.00	\$40,999	N	N
EDN100	7/28/2009	302A-1116, HRS	79713	Secondary Teacher	Certificated	T01	05	T	N	1.00	\$45,607	Y	N
EDN100	7/28/2009	302A-1116, HRS	79715	Elem Teacher	Certificated	T01	05	T	N	1.00	\$65,601	Y	N
EDN100	7/28/2009	302A-1116, HRS	79716	Secondary Teacher	Certificated	T01	05	T	N	1.00	\$31,077	Y	N
EDN100	7/28/2009	302A-1116, HRS	79717	Elem Teacher	Certificated	T01	05	T	N	1.00	\$66,027	Y	N
EDN100	7/28/2009	302A-1116, HRS	79721	Dist Off Tchr	Certificated	T02	05	T	N	1.00	\$57,692	Y	N
EDN100	7/28/2009	302A-1116, HRS	79729	Secondary Teacher	Certificated	T01	05	T	N	1.00	\$46,049	Y	N
EDN100	7/28/2009	302A-1116, HRS	79746	Secondary Teacher	Certificated	T01	05	T	N	1.00	\$81,011	Y	N
EDN100	7/28/2009	302A-1116, HRS	79752	Secondary Teacher	Certificated	T01	05	T	N	1.00	\$44,800	Y	N
EDN100	7/28/2009	302A-1116, HRS	79755	State Office Teacher	Certificated	T05	05	T	N	1.00	\$57,185	Y	N
EDN100	7/28/2009	302A-1116, HRS	79760	Secondary Teacher	Certificated	T01	05	T	N	1.00	\$51,151	Y	N
EDN100	7/28/2009	302A-1116, HRS	79764	Elem Teacher	Certificated	T01	05	T	N	1.00	\$63,040	Y	N
EDN100	7/28/2009	302A-1116, HRS	79765	Secondary Teacher	Certificated	T01	05	T	N	1.00	\$43,496	Y	N
EDN100	7/28/2009	302A-1116, HRS	79770	Secondary Teacher	Certificated	T01	05	T	N	0.50	\$22,139	Y	N
EDN100	7/28/2009	302A-1116, HRS	79774	Elem Teacher	Certificated	T01	05	T	N	1.00	\$52,840	Y	N
EDN100	3/1/2012	302A-1116, HRS	79775	State Office Teacher	Certificated	T05	05	T	N	1.00	\$66,880	Y	N
EDN100	3/1/2012	302A-1116, HRS	79790	Spec Prog Mgmt Spec II	Certificated	E07	06	T	N	1.00	\$73,216	Y	N
EDN100	1/3/2013	302A-1116, HRS	79792	Educational Spec II	Y	E07	06	T	N	1.00	\$73,216	Y	N
EDN100	7/28/2009	302A-1116, HRS	79800	State Office Teacher	Certificated	T05	05	T	N	1.00	\$50,808	Y	N
EDN100	7/28/2009	302A-1116, HRS	79801	State Office Teacher	Certificated	T05	05	T	N	1.00	\$47,432	Y	N
EDN100	7/28/2009	302A-1116, HRS	79802	State Office Teacher	Certificated	T05	05	T	N	1.00	\$61,205	Y	N
EDN100	7/28/2009	302A-1116, HRS	79804	Elem Teacher	Certificated	T01	05	T	N	1.00	\$55,780	Y	N
EDN100	7/28/2009	302A-1116, HRS	79806	Secondary Teacher	Certificated	T01	05	T	N	1.00	\$44,278	Y	N

Department of Education
Unappropriated Positions as of June 28, 2013

Table 17

<u>Prog ID</u>	<u>Date Established</u>	<u>Legal Authority</u>	<u>Position Number</u>	<u>Position Title</u>	<u>Exempt (Y/N)</u>	<u>SR Level</u>	<u>BU Code</u>	<u>T/P</u>	<u>MOF</u>	<u>FTE</u>	<u>Annual Salary</u>	<u>Filled (Y/N)</u>	<u>Occupied by 89 Day Hire (Y/N)</u>
EDN100	7/28/2009	302A-1116, HRS	79823	Elem Teacher	Certificated	T01	05	T	N	1.00	\$46,975	Y	N
EDN100	7/28/2009	302A-1116, HRS	79831	Elem Teacher	Certificated	T01	05	T	N	0.50	\$26,818	N	N
EDN100	7/28/2009	302A-1116, HRS	79832	Elem Teacher	Certificated	T01	05	T	N	1.00	\$53,635	Y	N
EDN100	7/28/2009	302A-1116, HRS	79848	Title I Linker Teacher	Certificated	T02	05	T	N	1.00	\$64,933	Y	N
EDN100	7/28/2009	302A-1116, HRS	79849	Title I Linker Teacher	Certificated	T02	05	T	N	1.00	\$48,854	N	N
EDN100	7/28/2009	302A-1116, HRS	79852	Title I Linker Teacher	Certificated	T02	05	T	N	1.00	\$68,887	Y	N
EDN100	7/28/2009	302A-1116, HRS	79853	Title I Linker Teacher	Certificated	T02	05	T	N	1.00	\$52,840	Y	N
EDN100	7/28/2009	302A-1116, HRS	79855	Title I Linker Teacher	Certificated	T02	05	T	N	1.00	\$63,094	Y	N
EDN100	7/28/2009	302A-1116, HRS	79856	Title I Linker Teacher	Certificated	T02	05	T	N	1.00	\$59,422	Y	N
EDN100	7/28/2009	302A-1116, HRS	79857	Title I Linker Teacher	Certificated	T02	05	T	N	1.00	\$51,829	Y	N
EDN100	7/28/2009	302A-1116, HRS	79877	Secondary Teacher	Certificated	T01	05	T	N	1.00	\$49,329	Y	N
EDN100	4/17/2000	302A-1116, HRS	79887	Voc/Tech Educ Spec II	Certificated	E07	06	T	N	1.00	\$85,313	Y	N
EDN100	2/16/2000	302A-1116, HRS	79889	Voc/Tech Educ Spec II	Certificated	E07	06	T	N	1.00	\$73,216	Y	N
EDN100	7/28/2009	302A-1116, HRS	79898	Elem Teacher	Certificated	T01	05	T	N	1.00	\$52,072	Y	N
EDN100	7/28/2009	302A-1116, HRS	79908	Secondary Teacher	Certificated	T01	05	T	N	1.00	\$48,215	Y	N
EDN100	7/28/2009	302A-1116, HRS	79912	Secondary Teacher	Certificated	T01	05	T	N	1.00	\$44,278	Y	N
EDN100	7/28/2009	302A-1116, HRS	79914	Elem Teacher	Certificated	T01	05	T	N	1.00	\$44,278	Y	N
EDN100	7/28/2009	302A-1116, HRS	79918	Secondary Teacher	Certificated	T01	05	T	N	1.00	\$44,278	Y	N
EDN100	7/28/2009	302A-1116, HRS	79923	Elem Teacher	Certificated	T01	05	T	N	1.00	\$40,999	Y	N
EDN100	7/28/2009	302A-1116, HRS	79962	Elem Teacher	Certificated	T01	05	T	N	1.00	\$48,215	Y	N
EDN100	7/28/2009	302A-1116, HRS	79963	Dist Off Tchr	Certificated	T02	05	T	N	1.00	\$53,385	Y	N
EDN100	7/28/2009	302A-1116, HRS	79969	Elem Teacher	Certificated	T01	05	T	N	1.00	\$51,151	Y	N
EDN100	7/28/2009	302A-1116, HRS	79980	Elem Teacher	Certificated	T01	05	T	N	1.00	\$52,072	Y	N
EDN100	7/28/2009	302A-1116, HRS	79981	Elem Teacher	Certificated	T01	05	T	N	0.50	\$28,005	Y	N
EDN100	7/28/2009	302A-1116, HRS	79996	Dist Off Tchr	Certificated	T02	05	T	N	1.00	\$67,863	Y	N
EDN100	7/1/2007	302A-1116, HRS	117225	Military Liaison Adm Asst	Y	SRNA	13	T	N	1.00	\$53,000	Y	N
EDN100	7/27/2010	302A-1116, HRS	600009	Dist Off Tchr	Certificated	T02	05	T	N	1.00	\$45,607	Y	N
EDN100	7/27/2010	302A-1116, HRS	600086	Elem Teacher	Certificated	T01	05	T	N	1.00	\$48,854	Y	N
EDN100	7/27/2010	302A-1116, HRS	600093	Elem Teacher	Certificated	T01	05	T	N	1.00	\$59,422	Y	N
EDN100	7/27/2010	302A-1116, HRS	600101	Elem Teacher	Certificated	T01	05	T	N	1.00	\$40,999	Y	N
EDN100	7/27/2010	302A-1116, HRS	600102	Elem Teacher	Certificated	T01	05	T	N	0.50	\$29,711	Y	N
EDN100	7/27/2010	302A-1116, HRS	600178	Elem Teacher	Certificated	T01	05	T	N	1.00	\$40,999	Y	N
EDN100	7/27/2010	302A-1116, HRS	600202	Elem Teacher	Certificated	T01	05	T	N	1.00	\$47,891	Y	N
EDN100	7/27/2010	302A-1116, HRS	600252	Secondary Teacher	Certificated	T01	05	T	N	1.00	\$44,278	Y	N
EDN100	7/27/2010	302A-1116, HRS	600253	Secondary Teacher	Certificated	T01	05	T	N	1.00	\$40,999	N	N
EDN100	7/27/2010	302A-1116, HRS	600255	Secondary Teacher	Certificated	T01	05	T	N	0.50	\$23,716	Y	N
EDN100	7/27/2010	302A-1116, HRS	600350	Elem Teacher	Certificated	T01	05	T	N	1.00	\$48,215	N	N
EDN100	7/27/2010	302A-1116, HRS	600367	Secondary Teacher	Certificated	T01	05	T	N	0.50	\$24,192	Y	N
EDN100	7/27/2010	302A-1116, HRS	600412	Secondary Teacher	Certificated	T01	05	T	N	1.00	\$66,299	Y	N
EDN100	7/27/2010	302A-1116, HRS	600468	Dist Off Tchr	Certificated	T02	05	T	N	1.00	\$55,520	Y	N
EDN100	7/27/2010	302A-1116, HRS	600471	Dist Off Tchr	Certificated	T02	05	T	N	1.00	\$40,999	N	N
EDN100	7/27/2010	302A-1116, HRS	600474	Dist Off Tchr	Certificated	T02	05	T	N	1.00	\$40,999	N	N
EDN100	7/27/2010	302A-1116, HRS	600475	Dist Off Tchr	Certificated	T02	05	T	N	1.00	\$40,999	N	N
EDN100	6/14/2010	302A-1116, HRS	600588	Dist Off Tchr	Certificated	T02	05	T	N	1.00	\$48,384	Y	N
EDN100	7/27/2010	302A-1116, HRS	600600	Dist Off Tchr	Certificated	T02	05	T	T	1.00	\$55,916	Y	N

Department of Education
Unappropriated Positions as of June 28, 2013

Table 17

<u>Prog ID</u>	<u>Date Established</u>	<u>Legal Authority</u>	<u>Position Number</u>	<u>Position Title</u>	<u>Exempt (Y/N)</u>	<u>SR Level</u>	<u>BU Code</u>	<u>T/P</u>	<u>MOF</u>	<u>FTE</u>	<u>Annual Salary</u>	<u>Filled (Y/N)</u>	<u>Occupied by 89 Day Hire (Y/N)</u>
EDN100	7/27/2010	302A-1116, HRS	600712	Secondary Teacher	Certificated	T01	05	T	N	1.00	\$54,458	Y	N
EDN100	7/27/2010	302A-1116, HRS	600713	Secondary Teacher	Certificated	T01	05	T	N	1.00	\$70,953	Y	N
EDN100	7/27/2010	302A-1116, HRS	600714	Secondary Teacher	Certificated	T01	05	T	N	1.00	\$40,999	Y	N
EDN100	7/27/2010	302A-1116, HRS	600715	Secondary Teacher	Certificated	T01	05	T	N	1.00	\$64,933	Y	N
EDN100	7/27/2010	302A-1116, HRS	600716	Secondary Teacher	Certificated	T01	05	T	N	1.00	\$50,808	Y	N
EDN100	7/27/2010	302A-1116, HRS	600717	Secondary Teacher	Certificated	T01	05	T	N	1.00	\$45,607	Y	N
EDN100	7/27/2010	302A-1116, HRS	600718	Secondary Teacher	Certificated	T01	05	T	N	1.00	\$64,933	Y	N
EDN100	7/27/2010	302A-1116, HRS	600719	Secondary Teacher	Certificated	T01	05	T	N	1.00	\$40,999	Y	N
EDN100	7/27/2010	302A-1116, HRS	600755	Elem Teacher	Certificated	T01	05	T	N	1.00	\$75,211	Y	N
EDN100	7/27/2010	302A-1116, HRS	600775	Secondary Teacher	Certificated	T01	05	T	N	1.00	\$40,999	N	N
EDN100	7/27/2010	302A-1116, HRS	600776	Secondary Teacher	Certificated	T01	05	T	N	1.00	\$46,049	Y	N
EDN100	7/24/2012	302A-1116, HRS	600806	Secondary Teacher	Certificated	T01	05	T	N	1.00	\$44,278	Y	N
EDN100	10/9/2012	302A-1116, HRS	600817	Secondary Teacher	Certificated	T01	05	T	T	0.50	\$27,958	Y	N
EDN100	7/1/2010	302A-1116, HRS	600826	Complex Academic Officer	Certificated	E07	06	T	N	1.00	\$92,734	Y	N
EDN100	7/27/2010	302A-1116, HRS	600833	Secondary Teacher	Certificated	T01	05	T	N	1.00	\$44,278	Y	N
EDN100	8/30/2010	302A-1116, HRS	600869	Secondary Teacher	Certificated	T01	05	T	N	1.00	\$67,846	Y	N
EDN100	8/26/2010	302A-1116, HRS	600873	Dist Off Tchr	Certificated	T02	05	T	N	1.00	\$58,901	Y	N
EDN100	10/25/2010	302A-1116, HRS	600952	Dist Off Tchr	Certificated	T02	05	T	N	1.00	\$64,933	Y	N
EDN100	10/25/2010	302A-1116, HRS	600953	Dist Off Tchr	Certificated	T02	05	T	N	1.00	\$46,975	Y	N
EDN100	7/24/2012	302A-1116, HRS	600965	Elem Teacher	Certificated	T01	05	T	N	1.00	\$54,426	Y	N
EDN100	7/24/2012	302A-1116, HRS	600966	Elem Teacher	Certificated	T01	05	T	N	1.00	\$46,975	Y	N
EDN100	1/4/2012	302A-1116, HRS	601027	Dist Off Tchr	Certificated	T02	05	T	N	1.00	\$63,040	Y	N
EDN100	7/26/2011	302A-1116, HRS	601162	Secondary Teacher	Certificated	T01	05	T	N	1.00	\$40,999	Y	N
EDN100	2/1/2011	302A-1116, HRS	601164	Secondary Teacher	Certificated	T01	05	T	N	1.00	\$54,181	Y	N
EDN100	1/24/2011	302A-1116, HRS	601180	Secondary Teacher	Certificated	T01	05	T	N	1.00	\$46,975	Y	N
EDN100	7/26/2011	302A-1116, HRS	601680	Elem Teacher	Certificated	T01	05	T	N	1.00	\$40,999	N	N
EDN100	7/26/2011	302A-1116, HRS	601758	Elem Teacher	Certificated	T01	05	T	N	1.00	\$44,503	Y	N
EDN100	7/26/2011	302A-1116, HRS	601765	Elem Teacher	Certificated	T01	05	T	N	1.00	\$40,999	N	N
EDN100	2/9/2011	302A-1116, HRS	601804	District Educ Spec II	Certificated	E07	06	T	N	1.00	\$84,136	Y	N
EDN100	2/25/2011	302A-1116, HRS	601890	Secondary Teacher	Certificated	T01	05	T	N	1.00	\$46,975	Y	N
EDN100	7/26/2011	302A-1116, HRS	601925	Elem Teacher	Certificated	T01	05	T	N	1.00	\$46,975	Y	N
EDN100	7/1/2011	302A-1116, HRS	601980	12-Mo State Off Tchr	Certificated	T02	05	T	N	1.00	\$71,306	Y	N
EDN100	7/1/2011	302A-1116, HRS	601981	12-Mo State Off Tchr	Certificated	T02	05	T	N	1.00	\$77,919	Y	N
EDN100	7/1/2011	302A-1116, HRS	601982	12-Mo State Off Tchr	Certificated	T02	05	T	N	1.00	\$74,054	Y	N
EDN100	7/1/2011	302A-1116, HRS	601983	12-Mo State Off Tchr	Certificated	T02	05	T	N	1.00	\$77,919	Y	N
EDN100	7/1/2011	302A-1116, HRS	601984	12-Mo State Off Tchr	Certificated	T02	05	T	N	1.00	\$62,196	Y	N
EDN100	7/1/2011	302A-1116, HRS	601985	12-Mo State Off Tchr	Certificated	T02	05	T	N	1.00	\$69,231	Y	N
EDN100	7/1/2011	302A-1116, HRS	601986	12-Mo State Off Tchr	Certificated	T02	05	T	N	1.00	\$77,919	Y	N
EDN100	7/1/2011	302A-1116, HRS	601987	12-Mo State Off Tchr	Certificated	T02	05	T	N	1.00	\$58,625	Y	N
EDN100	7/1/2011	302A-1116, HRS	601988	12-Mo State Off Tchr	Certificated	T02	05	T	N	1.00	\$40,999	N	N
EDN100	7/1/2011	302A-1116, HRS	601989	12-Mo State Off Tchr	Certificated	T02	05	T	N	1.00	\$67,308	Y	N
EDN100	7/1/2011	302A-1116, HRS	601990	12-Mo State Off Tchr	Certificated	T02	05	T	N	1.00	\$82,664	Y	N
EDN100	7/1/2011	302A-1116, HRS	601991	12-Mo State Off Tchr	Certificated	T02	05	T	N	1.00	\$87,487	Y	N
EDN100	7/1/2011	302A-1116, HRS	601992	12-Mo State Off Tchr	Certificated	T02	05	T	N	1.00	\$79,039	Y	N
EDN100	7/1/2011	302A-1116, HRS	601993	12-Mo State Off Tchr	Certificated	T02	05	T	N	1.00	\$67,213	Y	N

Department of Education
Unappropriated Positions as of June 28, 2013

Table 17

<u>Prog ID</u>	<u>Date Established</u>	<u>Legal Authority</u>	<u>Position Number</u>	<u>Position Title</u>	<u>Exempt (Y/N)</u>	<u>SR Level</u>	<u>BU Code</u>	<u>T/P</u>	<u>MOF</u>	<u>FTE</u>	<u>Annual Salary</u>	<u>Filled (Y/N)</u>	<u>Occupied by 89 Day Hire (Y/N)</u>
EDN100	7/1/2011	302A-1116, HRS	601994	12-Mo State Off Tchr	Certificated	T02	05	T	N	1.00	\$74,054	Y	N
EDN100	7/1/2011	302A-1116, HRS	601995	12-Mo State Off Tchr	Certificated	T02	05	T	N	1.00	\$69,231	Y	N
EDN100	7/27/2010	302A-1116, HRS	601996	Elem Teacher	Certificated	T01	05	T	N	1.00	\$50,808	Y	N
EDN100	7/26/2011	302A-1116, HRS	602021	Elem Teacher	Certificated	T01	05	T	N	1.00	\$40,999	Y	N
EDN100	7/26/2011	302A-1116, HRS	602030	Spec Ed Teacher	Certificated	T01	05	T	A	1.00	\$55,916	Y	N
EDN100	7/26/2011	302A-1116, HRS	602032	Secondary Teacher	Certificated	T01	05	T	T	0.50	\$27,958	Y	N
EDN100	7/26/2011	302A-1116, HRS	602093	Elem Teacher	Certificated	T01	05	T	N	1.00	\$56,010	Y	N
EDN100	7/26/2011	302A-1116, HRS	602125	Dist Off Tchr	Certificated	T02	05	T	N	1.00	\$52,332	Y	N
EDN100	7/26/2011	302A-1116, HRS	602126	Dist Off Tchr	Certificated	T02	05	T	N	1.00	\$52,840	Y	N
EDN100	7/26/2011	302A-1116, HRS	602129	Secondary Teacher	Certificated	T01	05	T	N	0.50	\$22,139	Y	N
EDN100	7/26/2011	302A-1116, HRS	602175	Secondary Teacher	Certificated	T01	05	T	N	1.00	\$68,887	Y	N
EDN100	7/1/2011	302A-1116, HRS	602194	District Educ Spec II	Certificated	E07	06	T	N	1.00	\$90,190	Y	N
EDN100	7/26/2011	302A-1116, HRS	602195	Dist Off Tchr	Certificated	T02	05	T	N	1.00	\$40,999	N	N
EDN100	7/26/2011	302A-1116, HRS	602214	Elem Teacher	Certificated	T01	05	T	N	1.00	\$40,999	Y	N
EDN100	7/1/2011	302A-1116, HRS	602282	12-Mo Secondary Teacher	Certificated	T02	05	T	N	1.00	\$67,213	Y	N
EDN100	7/1/2011	302A-1116, HRS	602283	12-Mo Secondary Teacher	Certificated	T02	05	T	N	1.00	\$69,231	Y	N
EDN100	7/26/2011	302A-1116, HRS	602289	Elem Teacher	Certificated	T01	05	T	N	1.00	\$40,999	Y	N
EDN100	7/26/2011	302A-1116, HRS	602304	Secondary Teacher	Certificated	T01	05	T	N	1.00	\$44,278	Y	N
EDN100	7/26/2011	302A-1116, HRS	602305	Secondary Teacher	Certificated	T01	05	T	N	1.00	\$61,841	Y	N
EDN100	7/26/2011	302A-1116, HRS	602307	Elem Teacher	Certificated	T01	05	T	N	1.00	\$57,692	Y	N
EDN100	7/26/2011	302A-1116, HRS	602316	Secondary Teacher	Certificated	T01	05	T	N	1.00	\$52,072	Y	N
EDN100	7/26/2011	302A-1116, HRS	602317	Secondary Teacher	Certificated	T01	05	T	N	1.00	\$52,072	Y	N
EDN100	7/26/2011	302A-1116, HRS	602318	Secondary Teacher	Certificated	T01	05	T	N	1.00	\$44,278	Y	N
EDN100	7/26/2011	302A-1116, HRS	602319	Secondary Teacher	Certificated	T01	05	T	N	1.00	\$44,278	Y	N
EDN100	7/26/2011	302A-1116, HRS	602320	Secondary Teacher	Certificated	T01	05	T	N	1.00	\$50,808	Y	N
EDN100	7/26/2011	302A-1116, HRS	602325	Secondary Teacher	Certificated	T01	05	T	N	1.00	\$67,846	Y	N
EDN100	7/26/2011	302A-1116, HRS	602326	Secondary Teacher	Certificated	T01	05	T	N	1.00	\$67,249	Y	N
EDN100	7/26/2011	302A-1116, HRS	602328	Secondary Teacher	Certificated	T01	05	T	N	1.00	\$45,607	Y	N
EDN100	7/26/2011	302A-1116, HRS	602331	Secondary Teacher	Certificated	T01	05	T	N	1.00	\$44,278	Y	N
EDN100	7/26/2011	302A-1116, HRS	602344	Elem Teacher	Certificated	T01	05	T	N	1.00	\$54,426	Y	N
EDN100	7/26/2011	302A-1116, HRS	602429	Educational Spec II	Y	E07	06	T	N	1.00	\$85,313	Y	N
EDN100	7/26/2011	302A-1116, HRS	602430	Educational Spec II	Y	E07	06	T	N	1.00	\$77,401	Y	N
EDN100	11/1/2011	302A-1116, HRS	602476	Pre-Sch Tchr	Certificated	T	05	T	A	1.00	\$55,916	Y	N
EDN100	11/1/2011	302A-1116, HRS	602477	Pre-Sch Tchr	Certificated	T	05	T	A	1.00	\$55,916	Y	N
EDN100	11/1/2011	302A-1116, HRS	602478	Pre-Sch Tchr	Certificated	T	05	T	A	1.00	\$55,916	Y	N
EDN100	11/1/2011	302A-1116, HRS	602479	Pre-Sch Tchr	Certificated	T	05	T	A	1.00	\$55,916	N	N
EDN100	1/4/2012	302A-1116, HRS	602518	Elem Teacher	Certificated	T01	05	T	N	1.00	\$56,010	Y	N
EDN100	1/4/2012	302A-1116, HRS	602534	Elem Teacher	Certificated	T01	05	T	N	1.00	\$52,840	Y	N
EDN100	1/4/2012	302A-1116, HRS	602535	Dist Off Tchr	Certificated	T02	05	T	N	1.00	\$59,422	Y	N
EDN100	7/16/2012	302A-1116, HRS	602544	Secondary Teacher	Certificated	T01	05	T	N	1.00	\$52,072	Y	N
EDN100	7/16/2012	302A-1116, HRS	602549	Secondary Teacher	Certificated	T01	05	T	N	1.00	\$52,072	Y	N
EDN100	7/24/2012	302A-1116, HRS	602616	Secondary Teacher	Certificated	T01	05	T	N	1.00	\$45,286	Y	N
EDN100	7/16/2012	302A-1116, HRS	602625	Elem Teacher	Certificated	T01	05	T	N	1.00	\$48,215	Y	N
EDN100	7/16/2012	302A-1116, HRS	602626	Elem Teacher	Certificated	T01	05	T	N	1.00	\$40,999	N	N
EDN100	7/16/2012	302A-1116, HRS	602771	Elem Teacher	Certificated	T01	05	T	N	1.00	\$52,072	Y	N

Department of Education
Unappropriated Positions as of June 28, 2013

Table 17

<u>Prog ID</u>	<u>Date Established</u>	<u>Legal Authority</u>	<u>Position Number</u>	<u>Position Title</u>	<u>Exempt (Y/N)</u>	<u>SR Level</u>	<u>BU Code</u>	<u>T/P</u>	<u>MOF</u>	<u>FTE</u>	<u>Annual Salary</u>	<u>Filled (Y/N)</u>	<u>Occupied by 89 Day Hire (Y/N)</u>
EDN100	7/24/2012	302A-1116, HRS	602779	Elem Teacher	Certificated	T01	05	T	N	0.50	\$24,918	Y	N
EDN100	7/24/2012	302A-1116, HRS	602805	Secondary Teacher	Certificated	T01	05	T	N	1.00	\$45,607	Y	N
EDN100	7/24/2012	302A-1116, HRS	603005	Dist Off Tchr	Certificated	T02	05	T	N	1.00	\$40,999	N	N
EDN100	7/24/2012	302A-1116, HRS	603151	Dist Off Tchr	Certificated	T02	05	T	N	1.00	\$50,808	Y	N
EDN100	7/24/2012	302A-1116, HRS	603156	Secondary Teacher	Certificated	T01	05	T	N	0.50	\$23,488	Y	N
EDN100	7/1/2012	302A-1116, HRS	603159	12-Mo State Off Tchr	Certificated	T02	05	T	N	1.00	\$58,625	Y	N
EDN100	7/24/2012	302A-1116, HRS	603164	State Office Teacher	Certificated	T05	05	T	P	0.50	\$23,946	Y	N
EDN100	2/1/2012	302A-1116, HRS	603175	Dist Off Tchr	Certificated	T02	05	T	N	1.00	\$60,668	Y	N
EDN100	7/26/2011	302A-1116, HRS	603176	Secondary Teacher	Certificated	T01	05	T	N	1.00	\$40,999	Y	N
EDN100	7/24/2012	302A-1116, HRS	603186	Dist Off Tchr	Certificated	T02	05	T	N	1.00	\$40,999	N	N
EDN100	7/24/2012	302A-1116, HRS	603216	Dist Off Tchr	Certificated	T02	05	T	N	1.00	\$57,692	Y	N
EDN100	7/1/2012	302A-1116, HRS	603311	12-Mo State Off Tchr	Certificated	T02	05	T	N	1.00	\$63,408	Y	N
EDN100	7/24/2012	302A-1116, HRS	603312	Secondary Teacher	Certificated	T01	05	T	N	1.00	\$43,496	Y	N
EDN100	7/1/2012	302A-1116, HRS	603313	12-Mo Dist Off Tchr	Certificated	T02	05	T	N	1.00	\$77,919	Y	N
EDN100	7/24/2012	302A-1116, HRS	603329	Elem Teacher	Certificated	T01	05	T	N	1.00	\$48,854	Y	N
EDN100	7/24/2012	302A-1116, HRS	603340	Elem Teacher	Certificated	T01	05	T	N	1.00	\$40,999	Y	N
EDN100	7/24/2012	302A-1116, HRS	603342	Secondary Teacher	Certificated	T01	05	T	N	1.00	\$39,546	Y	N
EDN100	7/24/2012	302A-1116, HRS	603343	Elem Teacher	Certificated	T01	05	T	N	1.00	\$45,607	Y	N
EDN100	7/24/2012	302A-1116, HRS	603450	Elem Teacher	Certificated	T01	05	T	N	1.00	\$40,999	N	N
EDN100	9/19/2012	302A-1116, HRS	603459	Complex Academic Officer	Certificated	E07	06	T	N	1.00	\$73,216	Y	N
EDN100	7/24/2012	302A-1116, HRS	603484	Secondary Teacher	Certificated	T01	05	T	N	1.00	\$57,692	N	N
EDN100	7/24/2012	302A-1116, HRS	603486	Secondary Teacher	Certificated	T01	05	T	N	1.00	\$59,422	Y	N
EDN100	7/24/2012	302A-1116, HRS	603487	Secondary Teacher	Certificated	T01	05	T	N	1.00	\$46,975	Y	N
EDN100	7/24/2012	302A-1116, HRS	603488	Elem Teacher	Certificated	T01	05	T	N	1.00	\$47,432	Y	N
EDN100	7/24/2012	302A-1116, HRS	603515	Secondary Teacher	Certificated	T01	05	T	N	1.00	\$31,077	Y	N
EDN100	7/24/2012	302A-1116, HRS	603537	Secondary Teacher	Certificated	T01	05	T	N	1.00	\$43,496	Y	N
EDN100	10/9/2012	302A-1116, HRS	603565	Dist Off Tchr	Certificated	T02	05	T	N	1.00	\$64,933	N	N
EDN100	8/1/2012	302A-1116, HRS	603584	State Office Teacher	Certificated	T05	05	T	N	1.00	\$57,692	Y	N
EDN100	8/8/2012	302A-1116, HRS	603601	Complex Academic Officer	Certificated	E07	06	T	N	1.00	\$73,216	Y	N
EDN100	8/20/2012	302A-1116, HRS	603608	12-Mo State Off Tchr	Certificated	T02	05	T	T	1.00	\$55,916	Y	N
EDN100	7/24/2012	302A-1116, HRS	603611	Elem Teacher	Certificated	T01	05	T	N	1.00	\$56,010	Y	N
EDN100	1/29/2013	302A-1116, HRS	603632	Secondary Teacher	Certificated	T01	05	T	N	0.50	\$35,381	Y	N
EDN100	9/4/2012	302A-1116, HRS	603645	Secondary Teacher	Certificated	T01	05	T	N	1.00	\$78,651	Y	N
EDN100	11/19/2012	302A-1116, HRS	603663	Elem Teacher	Certificated	T01	05	T	A	1.00	\$55,916	Y	N
EDN100	11/1/2012	302A-1116, HRS	603674	Dist Off Tchr	Certificated	T02	05	T	N	1.00	\$40,999	Y	N
EDN100	10/24/2012	302A-1116, HRS	603677	Educational Spec II	Y	E07	06	T	N	1.00	\$73,216	Y	N
EDN100	10/30/2012	302A-1116, HRS	603678	DOE Comm Spec II	Certificated	E07	06	T	N	1.00	\$73,216	Y	N
EDN100	1/2/2013	302A-1116, HRS	603686	Secondary Teacher	Certificated	T01	05	T	N	1.00	\$58,011	Y	N
EDN100	1/3/2013	302A-1116, HRS	603687	Counselor	Certificated	T01	05	T	A	1.00	\$55,916	Y	N
EDN100	1/3/2013	302A-1116, HRS	603689	Dist Off Tchr	Certificated	T02	05	T	N	1.00	\$44,278	Y	N
EDN100	1/3/2013	302A-1116, HRS	603692	Elem Teacher	Certificated	T01	05	T	N	1.00	\$48,215	Y	N
EDN100	7/24/2012	302A-1116, HRS	603693	Elem Teacher	Certificated	T01	05	T	N	1.00	\$40,999	Y	N
EDN100	1/7/2013	302A-1116, HRS	603694	Elem Teacher	Certificated	T01	05	T	A	1.00	\$55,916	N	N
EDN100	1/3/2013	302A-1116, HRS	603695	Spec Ed Teacher	Certificated	T01	05	T	A	1.00	\$55,916	Y	N
EDN100	1/3/2013	302A-1116, HRS	603698	State Office Teacher	Certificated	T05	05	T	N	1.00	\$59,422	Y	N

Department of Education
Unappropriated Positions as of June 28, 2013

Table 17

<u>Prog ID</u>	<u>Date Established</u>	<u>Legal Authority</u>	<u>Position Number</u>	<u>Position Title</u>	<u>Exempt (Y/N)</u>	<u>SR Level</u>	<u>BU Code</u>	<u>T/P</u>	<u>MOF</u>	<u>FTE</u>	<u>Annual Salary</u>	<u>Filled (Y/N)</u>	<u>Occupied by 89 Day Hire (Y/N)</u>
EDN100	1/3/2013	302A-1116, HRS	603703	Dist Off Tchr	Certificated	T02	05	T	N	1.00	\$56,010	Y	N
EDN100	1/3/2013	302A-1116, HRS	603705	Elem Teacher	Certificated	T01	05	T	A	1.00	\$55,916	Y	N
EDN100	1/3/2013	302A-1116, HRS	603707	Elem Teacher	Certificated	T01	05	T	A	0.50	\$27,958	Y	N
EDN100	1/7/2013	302A-1116, HRS	603709	Secondary Teacher	Certificated	T01	05	T	A	0.50	\$27,958	Y	N
EDN100	7/24/2012	302A-1116, HRS	603710	Secondary Teacher	Certificated	T01	05	T	N	1.00	\$53,848	Y	N
EDN100	1/7/2013	302A-1116, HRS	603711	Secondary Teacher	Certificated	T01	05	T	A	0.50	\$27,958	Y	N
EDN100	1/3/2013	302A-1116, HRS	603714	Elem Teacher	Certificated	T01	05	T	A	1.00	\$55,916	N	N
EDN100	1/22/2013	302A-1116, HRS	603716	Counselor	Certificated	T01	05	T	N	1.00	\$55,916	Y	N
EDN100	1/22/2013	302A-1116, HRS	603717	Counselor	Certificated	T01	05	T	N	1.00	\$55,916	Y	N
EDN100	1/28/2013	302A-1116, HRS	603718	Elem Teacher	Certificated	T01	05	T	A	1.00	\$55,916	Y	N
EDN100	1/30/2013	302A-1116, HRS	603751	Elem Teacher	Certificated	T01	05	T	A	1.00	\$55,916	N	N
EDN100	2/25/2013	302A-1116, HRS	603769	Elem Teacher	Certificated	T01	05	T	A	1.00	\$55,916	Y	N
EDN100	1/28/2013	302A-1116, HRS	603770	Counselor	Certificated	T01	05	T	A	1.00	\$55,916	Y	N
EDN100	2/5/2013	302A-1116, HRS	603808	Elem Teacher	Certificated	T01	05	T	A	1.00	\$55,916	N	N
EDN100	3/1/2013	302A-1116, HRS	604348	Elem Teacher	Certificated	T01	05	T	A	1.00	\$55,916	Y	N
EDN100	7/1/2012	302A-1116, HRS	800526	Educ Asst III	Y	SR12	03	T	N	1.00	\$30,036	Y	N
EDN100	7/1/2012	302A-1116, HRS	800527	Educ Asst III	Y	SR12	03	T	N	1.00	\$30,036	N	N
EDN100	10/3/2009	302A-1116, HRS	800750	Account Clerk III	N	SR11	03	T	N	1.00	\$28,836	Y	N
EDN100	10/1/2009	302A-1116, HRS	800751	Secretary I	N	SR12	03	T	N	0.50	\$15,018	Y	N
EDN100	6/1/2008	302A-1116, HRS	800802	Prgm Spclt IV	N	SR22	13	T	N	1.00	\$43,297	Y	N
EDN100	7/1/2010	302A-1116, HRS	800851	Legal Assistant III	N	SR20	13	T	T	1.00	\$41,040	N	N
EDN100	7/1/2009	302A-1116, HRS	800864	Account Clerk III	N	SR11	03	T	T	0.50	\$14,418	Y	N
EDN100	11/24/2008	302A-1116, HRS	800979	Prgm Spclt IV	N	SR22	13	T	W	0.50	\$21,649	Y	N
EDN100	3/18/2008	302A-1116, HRS	801024	Prgm Spclt V	N	SR24	13	T	W	1.00	\$48,746	Y	N
EDN100	3/18/2008	302A-1116, HRS	801025	Prgm Spclt V	N	SR24	13	T	W	1.00	\$48,746	Y	N
EDN100	5/15/2008	302A-1116, HRS	801055	Personnel Clerk V	N	SR13	03	T	N	1.00	\$29,651	Y	N
EDN100	5/15/2008	302A-1116, HRS	801056	Personnel Clerk V	N	SR13	03	T	N	1.00	\$29,651	Y	Y
EDN100	7/1/2010	302A-1116, HRS	801087	Data Procsg Sys Anal IV	N	SR22	13	T	N	1.00	\$43,297	N	N
EDN100	6/19/2008	302A-1116, HRS	801103	Personnel Clerk V	N	SR13	03	T	N	1.00	\$29,651	N	N
EDN100	6/19/2008	302A-1116, HRS	801105	Personnel Clerk V	N	SR13	03	T	N	1.00	\$29,651	N	N
EDN100	11/21/2008	302A-1116, HRS	801275	Personnel Mgmt Specialist IV	N	SR22	13	T	N	1.00	\$43,297	Y	Y
EDN100	11/21/2008	302A-1116, HRS	801276	Personnel Mgmt Specialist IV	N	SR22	13	T	N	1.00	\$43,297	N	N
EDN100	11/21/2008	302A-1116, HRS	801277	Personnel Mgmt Specialist IV	N	SR22	13	T	N	1.00	\$40,025	Y	N
EDN100	10/16/2009	302A-1116, HRS	801393	Legal Clerk	N	SR14	03	T	W	1.00	\$30,803	N	N
EDN100	9/15/2009	302A-1116, HRS	801435	Office Assistant II	N	SR06	03	T	T	1.00	\$25,668	N	N
EDN100	10/22/2009	302A-1116, HRS	801471	Office Assistant III	N	SR08	03	T	N	0.50	\$12,192	N	N
EDN100	4/7/2010	302A-1116, HRS	801519	Secretary IV	N	SR18	03	T	W	1.00	\$36,070	Y	N
EDN100	7/1/2010	302A-1116, HRS	801541	Office Assistant III	N	SR08	03	T	N	0.50	\$12,192	Y	N
EDN100	7/1/2010	302A-1116, HRS	801550	Educ Asst III	Y	SR12	03	T	N	1.00	\$25,705	Y	N
EDN100	7/1/2011	302A-1116, HRS	801647	School Security Attendant	N	SR07	03	T	A	0.75	\$17,562	Y	Y
EDN100	3/17/2011	302A-1116, HRS	802052	Account Clerk II	N	SR08	03	T	N	0.50	\$12,192	N	N
EDN100	11/10/2011	302A-1116, HRS	802419	Educ Asst III	Y	SR12	03	T	A	1.00	\$30,036	Y	N
EDN100	11/10/2011	302A-1116, HRS	802420	Educ Asst III	Y	SR12	03	T	A	1.00	\$30,036	Y	Y
EDN100	11/10/2011	302A-1116, HRS	802421	Educ Asst III	Y	SR12	03	T	A	1.00	\$30,036	N	N
EDN100	11/10/2011	302A-1116, HRS	802422	Educ Asst III	Y	SR12	03	T	A	1.00	\$30,036	Y	N

Department of Education
Unappropriated Positions as of June 28, 2013

Table 17

<u>Prog ID</u>	<u>Date Established</u>	<u>Legal Authority</u>	<u>Position Number</u>	<u>Position Title</u>	<u>Exempt (Y/N)</u>	<u>SR Level</u>	<u>BU Code</u>	<u>T/P</u>	<u>MOF</u>	<u>FTE</u>	<u>Annual Salary</u>	<u>Filled (Y/N)</u>	<u>Occupied by 89 Day Hire (Y/N)</u>
EDN100	2/6/2012	302A-1116, HRS	802481	Office Assistant III	N	SR08	03	T	T	1.00	\$25,668	N	N
EDN100	2/16/2012	302A-1116, HRS	802482	District PCNC Assistant	N	SR15	03	T	N	1.00	\$32,068	N	N
EDN100	7/1/2012	302A-1116, HRS	802673	Educ Asst III	Y	SR12	03	T	N	1.00	\$28,534	N	N
EDN100	8/8/2012	302A-1116, HRS	802727	EOEL Policy Analyst	N	SRNA	13	T	A	1.00	\$60,000	Y	N
EDN100	1/4/2013	302A-1116, HRS	802913	EOEL Project Manager	N	SRNA	13	T	A	1.00	\$80,000	Y	N
EDN100	1/4/2013	302A-1116, HRS	802914	EOEL Program Manager	N	SRNA	13	T	A	1.00	\$78,000	Y	N
EDN100	1/7/2013	302A-1116, HRS	802915	EOEL Operations & Fiscal Manager	N	SRNA	13	T	A	1.00	\$76,000	Y	N
EDN100	5/1/2013	302A-1116, HRS	802925	Office Assistant III	N	SR08	03	T	N	0.50	\$12,193	Y	N
EDN150	7/1/2000	302A-1116, HRS	29559	Office Assistant III	N	SR08	03	T	N	1.00	\$36,070	N	N
EDN150	7/1/2000	302A-1116, HRS	32307	School Psychologist	Y	SR24	13	T	N	1.00	\$48,746	N	N
EDN150	7/1/2011	302A-1116, HRS	32931	Secretary II	N	SR14	03	T	N	1.00	\$30,803	Y	N
EDN150	7/1/2008	302A-1116, HRS	35423	Account Clerk III	N	SR11	03	T	N	1.00	\$33,311	Y	N
EDN150	7/1/2000	302A-1116, HRS	38737	Office Assistant III	N	SR08	03	T	N	1.00	\$24,385	Y	N
EDN150	7/1/2000	302A-1116, HRS	42661	Secretary II	N	SR14	03	T	N	1.00	\$32,068	Y	N
EDN150	7/1/2000	302A-1116, HRS	43047	Office Assistant III	N	SR08	03	T	N	1.00	\$27,394	Y	N
EDN150	7/1/2000	302A-1116, HRS	43843	Account Clerk III	N	SR11	03	T	N	1.00	\$27,394	Y	N
EDN150	5/27/2011	302A-1116, HRS	49258	Secretary II	N	SR14	03	T	N	1.00	\$30,803	Y	N
EDN150	9/1/2000	302A-1116, HRS	53040	Educ Asst III	Y	SR12	03	T	N	0.50	\$14,267	N	N
EDN150	7/1/2002	302A-1116, HRS	54467	Office Assistant III	N	SR08	03	T	N	1.00	\$26,368	Y	N
EDN150	7/1/2000	302A-1116, HRS	55293	Office Assistant III	N	SR08	03	T	N	1.00	\$24,385	N	N
EDN150	7/1/2000	302A-1116, HRS	55319	Office Assistant III	N	SR08	03	T	N	1.00	\$24,385	N	N
EDN150	7/1/2000	302A-1116, HRS	55386	Secretary II	N	SR14	03	T	N	1.00	\$37,506	Y	N
EDN150	7/1/2000	302A-1116, HRS	55455	Office Assistant III	N	SR08	03	T	N	1.00	\$28,534	Y	N
EDN150	7/1/2006	302A-1116, HRS	55829	Office Assistant III	N	SR08	03	T	A	1.00	\$25,668	Y	N
EDN150	10/18/2000	302A-1116, HRS	56129	School Psychologist	Y	SR24	13	T	N	1.00	\$48,746	Y	Y
EDN150	4/25/2001	302A-1116, HRS	56343	Office Assistant III	N	SR08	03	T	N	1.00	\$24,385	N	N
EDN150	7/27/2011	302A-1116, HRS	56843	Educ Asst III	Y	SR12	03	T	N	1.00	\$30,036	Y	N
EDN150	10/12/2010	302A-1116, HRS	57056	Educ Asst III	Y	SR12	03	T	N	1.00	\$30,036	Y	N
EDN150	10/9/2012	302A-1116, HRS	57168	Educ Asst III	Y	SR12	03	T	N	1.00	\$30,036	Y	N
EDN150	9/4/2001	302A-1116, HRS	57376	Educ Asst III	Y	SR12	03	T	N	1.00	\$28,534	Y	Y
EDN150	8/5/2002	302A-1116, HRS	58108	Educ Asst III	Y	SR12	03	T	N	1.00	\$25,796	Y	N
EDN150	8/5/2002	302A-1116, HRS	58109	Educ Asst III	Y	SR12	03	T	N	1.00	\$24,824	Y	N
EDN150	8/5/2002	302A-1116, HRS	58110	Educ Asst III	Y	SR12	03	T	N	1.00	\$24,824	Y	N
EDN150	8/7/2002	302A-1116, HRS	58141	Educ Asst III	Y	SR12	03	T	N	1.00	\$24,824	Y	N
EDN150	8/8/2002	302A-1116, HRS	58146	Educ Asst III	Y	SR12	03	T	N	1.00	\$28,534	N	N
EDN150	8/8/2002	302A-1116, HRS	58148	Educ Asst III	Y	SR12	03	T	N	1.00	\$22,941	Y	N
EDN150	8/8/2002	302A-1116, HRS	58151	Educ Asst III	Y	SR12	03	T	N	1.00	\$28,534	N	N
EDN150	9/9/2002	302A-1116, HRS	58188	Educ Asst III	Y	SR12	03	T	N	1.00	\$21,214	Y	N
EDN150	10/28/2002	302A-1116, HRS	58286	Secretary II	N	SR14	03	T	N	1.00	\$36,070	Y	N
EDN150	12/24/2002	302A-1116, HRS	58598	Educ Asst III	Y	SR12	03	T	N	1.00	\$22,941	N	N
EDN150	2/18/2003	302A-1116, HRS	58661	Educ Asst III	Y	SR12	03	T	N	1.00	\$24,824	Y	N
EDN150	5/15/2003	302A-1116, HRS	58717	Educ Asst III	Y	SR12	03	T	N	1.00	\$24,824	Y	N
EDN150	5/15/2003	302A-1116, HRS	58718	Educ Asst III	Y	SR12	03	T	N	1.00	\$24,824	Y	N
EDN150	6/2/2003	302A-1116, HRS	58723	Educ Asst III	Y	SR12	03	T	N	1.00	\$24,824	Y	N
EDN150	9/15/2003	302A-1116, HRS	58851	Office Assistant III	N	SR08	03	T	N	1.00	\$27,394	Y	N

<u>Prog ID</u>	<u>Date Established</u>	<u>Legal Authority</u>	<u>Position Number</u>	<u>Position Title</u>	<u>Exempt (Y/N)</u>	<u>SR Level</u>	<u>BU Code</u>	<u>T/P</u>	<u>MOF</u>	<u>FTE</u>	<u>Annual Salary</u>	<u>Filled (Y/N)</u>	<u>Occupied by 89 Day Hire (Y/N)</u>
EDN150	7/27/2006	302A-1116, HRS	59623	DP User Support Tech II	N	SR15	03	T	N	1.00	\$32,068	Y	Y
EDN150	1/19/2006	302A-1116, HRS	59682	Office Assistant II	N	SR06	03	T	N	0.50	\$11,252	Y	Y
EDN150	7/28/2009	302A-1116, HRS	76369	Dist Off Tchr	Certificated	T02	05	T	N	1.00	\$40,999	N	N
EDN150	7/28/2009	302A-1116, HRS	79203	Dist Off Tchr	Certificated	T02	05	T	N	1.00	\$44,278	N	N
EDN150	7/1/2009	302A-1116, HRS	79232	12-Mo Dist Off Tchr	Certificated	T02	05	T	N	1.00	\$80,256	Y	N
EDN150	7/1/2009	302A-1116, HRS	79236	12-Mo Dist Off Tchr	Certificated	T02	05	T	N	1.00	\$69,231	Y	N
EDN150	7/1/2010	302A-1116, HRS	79242	Dist Off Tchr	Certificated	T02	05	T	N	1.00	\$44,278	Y	N
EDN150	7/1/2009	302A-1116, HRS	79251	12-Mo Dist Off Tchr	Certificated	T02	05	T	N	1.00	\$77,919	Y	N
EDN150	7/28/2009	302A-1116, HRS	79261	Dist Off Tchr	Certificated	T02	05	T	N	1.00	\$68,887	N	N
EDN150	7/28/2009	302A-1116, HRS	79262	Dist Off Tchr	Certificated	T02	05	T	N	1.00	\$46,049	Y	N
EDN150	12/6/2010	302A-1116, HRS	79283	12-Mo Dist Off Tchr	Certificated	T02	05	T	N	1.00	\$58,625	Y	N
EDN150	7/28/2009	302A-1116, HRS	79284	Dist Off Tchr	Certificated	T02	05	T	N	1.00	\$45,607	Y	N
EDN150	7/1/2009	302A-1116, HRS	79295	12-Mo Dist Off Tchr	Certificated	T02	05	T	N	1.00	\$82,664	Y	N
EDN150	7/1/2009	302A-1116, HRS	79324	District Educ Spec II	Certificated	E07	06	T	N	1.00	\$86,507	Y	N
EDN150	7/28/2009	302A-1116, HRS	79326	Dist Off Tchr	Certificated	T02	05	T	N	1.00	\$52,840	Y	N
EDN150	7/28/2009	302A-1116, HRS	79327	Dist Off Tchr	Certificated	T02	05	T	N	1.00	\$50,808	Y	N
EDN150	7/28/2009	302A-1116, HRS	79348	Dist Off Tchr	Certificated	T02	05	T	N	1.00	\$45,607	Y	N
EDN150	7/28/2009	302A-1116, HRS	79350	Dist Off Tchr	Certificated	T02	05	T	N	1.00	\$59,422	Y	N
EDN150	7/28/2009	302A-1116, HRS	79351	Dist Off Tchr	Certificated	T02	05	T	N	1.00	\$49,837	Y	N
EDN150	7/1/2009	302A-1116, HRS	79366	12-Mo Dist Off Tchr	Certificated	T02	05	T	N	1.00	\$71,306	Y	N
EDN150	7/1/2009	302A-1116, HRS	79367	12-Mo Dist Off Tchr	Certificated	T02	05	T	N	1.00	\$63,408	Y	N
EDN150	7/1/2009	302A-1116, HRS	79368	12-Mo Dist Off Tchr	Certificated	T02	05	T	N	1.00	\$82,664	Y	N
EDN150	7/1/2009	302A-1116, HRS	79369	12-Mo Dist Off Tchr	Certificated	T02	05	T	N	1.00	\$56,370	Y	N
EDN150	7/1/2009	302A-1116, HRS	79370	12-Mo Dist Off Tchr	Certificated	T02	05	T	N	1.00	\$67,213	Y	N
EDN150	7/28/2009	302A-1116, HRS	79371	Dist Off Tchr	Certificated	T02	05	T	N	1.00	\$64,933	Y	N
EDN150	7/1/2009	302A-1116, HRS	79372	12-Mo Dist Off Tchr	Certificated	T02	05	T	N	1.00	\$69,231	Y	N
EDN150	7/28/2009	302A-1116, HRS	79373	Dist Off Tchr	Certificated	T02	05	T	N	0.50	\$33,440	Y	N
EDN150	7/28/2009	302A-1116, HRS	79374	Dist Off Tchr	Certificated	T02	05	T	N	1.00	\$40,999	N	N
EDN150	7/28/2009	302A-1116, HRS	79375	Dist Off Tchr	Certificated	T02	05	T	N	1.00	\$75,211	Y	N
EDN150	7/28/2009	302A-1116, HRS	79376	Dist Off Tchr	Certificated	T02	05	T	N	1.00	\$45,607	Y	N
EDN150	7/28/2009	302A-1116, HRS	79377	Dist Off Tchr	Certificated	T02	05	T	N	1.00	\$44,278	Y	N
EDN150	7/28/2009	302A-1116, HRS	79378	Dist Off Tchr	Certificated	T02	05	T	N	1.00	\$81,011	Y	N
EDN150	7/28/2009	302A-1116, HRS	79379	Dist Off Tchr	Certificated	T02	05	T	N	1.00	\$59,422	Y	N
EDN150	7/1/2009	302A-1116, HRS	79393	District Educ Spec II	Certificated	E07	06	T	N	1.00	\$85,313	Y	N
EDN150	7/28/2009	302A-1116, HRS	79394	Dist Off Tchr	Certificated	T02	05	T	N	1.00	\$63,040	Y	N
EDN150	7/28/2009	302A-1116, HRS	79405	Dist Off Tchr	Certificated	T02	05	T	N	1.00	\$57,453	Y	N
EDN150	7/28/2009	302A-1116, HRS	79421	Dist Off Tchr	Certificated	T02	05	T	N	1.00	\$48,854	Y	N
EDN150	7/1/2009	302A-1116, HRS	79443	12-Mo Dist Off Tchr	Certificated	T02	05	T	N	1.00	\$67,213	Y	N
EDN150	7/28/2009	302A-1116, HRS	79448	Dist Off Tchr	Certificated	T02	05	T	N	1.00	\$59,422	Y	N
EDN150	7/28/2009	302A-1116, HRS	79449	Dist Off Tchr	Certificated	T02	05	T	N	1.00	\$45,607	Y	N
EDN150	7/1/2009	302A-1116, HRS	79450	12-Mo Dist Off Tchr	Certificated	T02	05	T	N	1.00	\$80,256	Y	N
EDN150	7/1/2009	302A-1116, HRS	79451	12-Mo Dist Off Tchr	Certificated	T02	05	T	N	1.00	\$82,664	Y	N
EDN150	7/28/2009	302A-1116, HRS	79501	Dist Off Tchr	Certificated	T02	05	T	N	1.00	\$44,278	Y	N
EDN150	7/1/2009	302A-1116, HRS	79505	12-Mo Dist Off Tchr	Certificated	T02	05	T	N	1.00	\$67,213	Y	N
EDN150	7/1/2009	302A-1116, HRS	79515	12-Mo Dist Off Tchr	Certificated	T02	05	T	N	1.00	\$68,622	Y	N

Department of Education
Unappropriated Positions as of June 28, 2013

Table 17

<u>Prog ID</u>	<u>Date Established</u>	<u>Legal Authority</u>	<u>Position Number</u>	<u>Position Title</u>	<u>Exempt (Y/N)</u>	<u>SR Level</u>	<u>BU Code</u>	<u>T/P</u>	<u>MOF</u>	<u>FTE</u>	<u>Annual Salary</u>	<u>Filled (Y/N)</u>	<u>Occupied by 89 Day Hire (Y/N)</u>
EDN150	7/1/2009	302A-1116, HRS	79518	12-Mo Dist Off Tchr	Certificated	T02	05	T	N	1.00	\$67,213	Y	N
EDN150	7/28/2009	302A-1116, HRS	79532	Dist Off Tchr	Certificated	T02	05	T	N	1.00	\$40,999	Y	N
EDN150	7/1/2009	302A-1116, HRS	79534	12-Mo Dist Off Tchr	Certificated	T02	05	T	N	1.00	\$56,370	Y	N
EDN150	7/28/2009	302A-1116, HRS	79538	Dist Off Tchr	Certificated	T02	05	T	N	1.00	\$48,854	Y	N
EDN150	7/1/2012	302A-1116, HRS	79540	12-Mo Dist Off Tchr	Certificated	T02	05	T	N	1.00	\$63,408	Y	N
EDN150	7/28/2009	302A-1116, HRS	79543	Dist Off Tchr	Certificated	T02	05	T	N	1.00	\$57,185	Y	N
EDN150	7/1/2009	302A-1116, HRS	79548	12-Mo Dist Off Tchr	Certificated	T02	05	T	N	1.00	\$60,970	Y	N
EDN150	7/28/2009	302A-1116, HRS	79557	Dist Off Tchr	Certificated	T02	05	T	N	1.00	\$40,999	N	N
EDN150	7/1/2009	302A-1116, HRS	79577	12-Mo Dist Off Tchr	Certificated	T02	05	T	N	1.00	\$65,311	Y	N
EDN150	7/1/2009	302A-1116, HRS	79595	12-Mo Dist Off Tchr	Certificated	T02	05	T	N	1.00	\$65,311	Y	N
EDN150	7/1/2009	302A-1116, HRS	79598	12-Mo Dist Off Tchr	Certificated	T02	05	T	N	1.00	\$73,509	Y	N
EDN150	7/28/2009	302A-1116, HRS	79606	Dist Off Tchr	Certificated	T02	05	T	N	1.00	\$66,880	Y	N
EDN150	7/1/2009	302A-1116, HRS	79612	12-Mo Dist Off Tchr	Certificated	T02	05	T	N	1.00	\$74,986	Y	N
EDN150	7/28/2009	302A-1116, HRS	79613	Dist Off Tchr	Certificated	T02	05	T	N	1.00	\$56,010	N	N
EDN150	7/1/2009	302A-1116, HRS	79624	12-Mo Dist Off Tchr	Certificated	T02	05	T	N	1.00	\$65,311	Y	N
EDN150	7/1/2009	302A-1116, HRS	79650	12-Mo Dist Off Tchr	Certificated	T02	05	T	N	1.00	\$40,999	N	N
EDN150	7/1/2009	302A-1116, HRS	79651	12-Mo Dist Off Tchr	Certificated	T02	05	T	N	1.00	\$90,253	Y	N
EDN150	7/1/2009	302A-1116, HRS	79688	12-Mo Dist Off Tchr	Certificated	T02	05	T	N	1.00	\$76,735	Y	N
EDN150	7/1/2009	302A-1116, HRS	79689	12-Mo Dist Off Tchr	Certificated	T02	05	T	N	1.00	\$75,649	Y	N
EDN150	7/1/2009	302A-1116, HRS	79694	12-Mo Dist Off Tchr	Certificated	T02	05	T	N	1.00	\$81,869	Y	N
EDN150	7/1/2009	302A-1116, HRS	79703	12-Mo Dist Off Tchr	Certificated	T02	05	T	N	1.00	\$77,919	Y	N
EDN150	7/1/2009	302A-1116, HRS	79704	12-Mo Dist Off Tchr	Certificated	T02	05	T	N	1.00	\$71,306	Y	N
EDN150	7/1/2009	302A-1116, HRS	79744	12-Mo Dist Off Tchr	Certificated	T02	05	T	N	1.00	\$79,039	Y	N
EDN150	7/1/2009	302A-1116, HRS	79751	12-Mo Dist Off Tchr	Certificated	T02	05	T	N	1.00	\$85,143	Y	N
EDN150	7/1/2009	302A-1116, HRS	79754	12-Mo Dist Off Tchr	Certificated	T02	05	T	N	1.00	\$74,265	Y	N
EDN150	7/1/2009	302A-1116, HRS	79757	12-Mo Dist Off Tchr	Certificated	T02	05	T	N	1.00	\$90,253	Y	N
EDN150	4/4/2011	302A-1116, HRS	79771	12-Mo Dist Off Tchr	Certificated	T02	05	T	N	1.00	\$67,213	Y	N
EDN150	7/28/2009	302A-1116, HRS	79776	Dist Off Tchr	Certificated	T02	05	T	N	1.00	\$44,278	Y	N
EDN150	7/28/2009	302A-1116, HRS	79782	Dist Off Tchr	Certificated	T02	05	T	N	1.00	\$64,933	Y	N
EDN150	7/1/2009	302A-1116, HRS	79783	12-Mo Dist Off Tchr	Certificated	T02	05	T	N	1.00	\$53,133	Y	N
EDN150	7/1/2009	302A-1116, HRS	79784	12-Mo Dist Off Tchr	Certificated	T02	05	T	N	1.00	\$80,256	Y	N
EDN150	7/1/2009	302A-1116, HRS	79795	District Educ Spec II	Certificated	E07	06	T	N	1.00	\$76,333	Y	N
EDN150	7/28/2009	302A-1116, HRS	79796	Dist Off Tchr	Certificated	T02	05	T	N	1.00	\$44,278	Y	N
EDN150	7/1/2009	302A-1116, HRS	79808	12-Mo Dist Off Tchr	Certificated	T02	05	T	N	1.00	\$64,357	Y	N
EDN150	7/1/2009	302A-1116, HRS	79809	12-Mo Dist Off Tchr	Certificated	T02	05	T	N	1.00	\$82,664	Y	N
EDN150	7/1/2009	302A-1116, HRS	79813	12-Mo Dist Off Tchr	Certificated	T02	05	T	N	1.00	\$62,196	Y	N
EDN150	7/1/2009	302A-1116, HRS	79815	12-Mo Dist Off Tchr	Certificated	T02	05	T	N	1.00	\$90,253	Y	N
EDN150	7/1/2009	302A-1116, HRS	79816	12-Mo Dist Off Tchr	Certificated	T02	05	T	N	1.00	\$67,271	Y	N
EDN150	7/1/2009	302A-1116, HRS	79818	12-Mo Dist Off Tchr	Certificated	T02	05	T	N	1.00	\$60,970	Y	N
EDN150	7/1/2009	302A-1116, HRS	79820	12-Mo Dist Off Tchr	Certificated	T02	05	T	N	1.00	\$65,982	Y	N
EDN150	7/28/2009	302A-1116, HRS	79821	Dist Off Tchr	Certificated	T02	05	T	N	1.00	\$44,278	Y	N
EDN150	4/25/2011	302A-1116, HRS	79824	12-Mo Dist Off Tchr	Certificated	T02	05	T	N	1.00	\$67,213	Y	N
EDN150	7/1/2009	302A-1116, HRS	79825	12-Mo Dist Off Tchr	Certificated	T02	05	T	N	1.00	\$69,231	Y	N
EDN150	7/1/2009	302A-1116, HRS	79826	12-Mo Dist Off Tchr	Certificated	T02	05	T	N	1.00	\$90,253	Y	N
EDN150	7/1/2009	302A-1116, HRS	79835	12-Mo Dist Off Tchr	Certificated	T02	05	T	N	1.00	\$67,213	Y	N

<u>Prog ID</u>	<u>Date Established</u>	<u>Legal Authority</u>	<u>Position Number</u>	<u>Position Title</u>	<u>Exempt (Y/N)</u>	<u>SR Level</u>	<u>BU Code</u>	<u>T/P</u>	<u>MOF</u>	<u>FTE</u>	<u>Annual Salary</u>	<u>Filled (Y/N)</u>	<u>Occupied by 89 Day Hire (Y/N)</u>
EDN150	7/1/2009	302A-1116, HRS	79840	12-Mo Dist Off Tchr	Certificated	T02	05	T	N	1.00	\$71,306	Y	N
EDN150	7/1/2009	302A-1116, HRS	79850	12-Mo Dist Off Tchr	Certificated	T02	05	T	N	1.00	\$64,683	Y	N
EDN150	7/1/2009	302A-1116, HRS	79854	12-Mo Dist Off Tchr	Certificated	T02	05	T	N	1.00	\$52,195	Y	N
EDN150	7/1/2009	302A-1116, HRS	79858	12-Mo Dist Off Tchr	Certificated	T02	05	T	N	1.00	\$77,919	Y	N
EDN150	7/1/2009	302A-1116, HRS	79860	12-Mo Dist Off Tchr	Certificated	T02	05	T	N	1.00	\$69,231	Y	N
EDN150	7/1/2009	302A-1116, HRS	79863	12-Mo Dist Off Tchr	Certificated	T02	05	T	N	1.00	\$90,253	Y	N
EDN150	7/1/2009	302A-1116, HRS	79866	12-Mo Dist Off Tchr	Certificated	T02	05	T	N	1.00	\$60,970	Y	N
EDN150	7/1/2009	302A-1116, HRS	79867	12-Mo Dist Off Tchr	Certificated	T02	05	T	N	1.00	\$71,306	Y	N
EDN150	7/28/2009	302A-1116, HRS	79870	Dist Off Tchr	Certificated	T02	05	T	N	1.00	\$50,808	Y	N
EDN150	7/28/2009	302A-1116, HRS	79872	Dist Off Tchr	Certificated	T02	05	T	N	1.00	\$40,999	Y	N
EDN150	7/1/2009	302A-1116, HRS	79880	12-Mo Dist Off Tchr	Certificated	T02	05	T	N	1.00	\$50,675	Y	N
EDN150	7/28/2009	302A-1116, HRS	79883	Dist Off Tchr	Certificated	T02	05	T	N	1.00	\$64,933	Y	N
EDN150	7/1/2009	302A-1116, HRS	79888	12-Mo Dist Off Tchr	Certificated	T02	05	T	N	1.00	\$82,664	Y	N
EDN150	7/16/2012	302A-1116, HRS	79899	12-Mo State Off Tchr	Certificated	T02	05	T	N	1.00	\$55,916	Y	N
EDN150	7/1/2009	302A-1116, HRS	79911	12-Mo Dist Off Tchr	Certificated	T02	05	T	N	1.00	\$77,919	Y	N
EDN150	7/28/2009	302A-1116, HRS	79943	Dist Off Tchr	Certificated	T02	05	T	N	1.00	\$46,975	Y	N
EDN150	7/1/2009	302A-1116, HRS	79953	12-Mo Dist Off Tchr	Certificated	T02	05	T	N	1.00	\$70,681	Y	N
EDN150	7/1/2009	302A-1116, HRS	79954	12-Mo Dist Off Tchr	Certificated	T02	05	T	N	1.00	\$69,231	Y	N
EDN150	7/1/2009	302A-1116, HRS	79955	12-Mo Dist Off Tchr	Certificated	T02	05	T	N	1.00	\$60,970	Y	N
EDN150	7/1/2009	302A-1116, HRS	79956	12-Mo Dist Off Tchr	Certificated	T02	05	T	N	1.00	\$60,970	Y	N
EDN150	7/28/2009	302A-1116, HRS	79957	Dist Off Tchr	Certificated	T02	05	T	N	1.00	\$57,692	Y	N
EDN150	7/28/2009	302A-1116, HRS	79961	Dist Off Tchr	Certificated	T02	05	T	N	1.00	\$40,999	Y	N
EDN150	7/28/2009	302A-1116, HRS	79966	Dist Off Tchr	Certificated	T02	05	T	N	1.00	\$64,933	Y	N
EDN150	7/1/2009	302A-1116, HRS	79972	12-Mo Dist Off Tchr	Certificated	T02	05	T	N	1.00	\$69,231	Y	N
EDN150	7/1/2009	302A-1116, HRS	79973	12-Mo Dist Off Tchr	Certificated	T02	05	T	N	1.00	\$71,306	Y	N
EDN150	7/1/2009	302A-1116, HRS	79977	12-Mo Dist Off Tchr	Certificated	T02	05	T	N	1.00	\$69,231	Y	N
EDN150	7/1/2009	302A-1116, HRS	79978	12-Mo Dist Off Tchr	Certificated	T02	05	T	N	1.00	\$56,370	Y	N
EDN150	7/1/2009	302A-1116, HRS	79979	12-Mo Dist Off Tchr	Certificated	T02	05	T	N	1.00	\$60,970	Y	N
EDN150	7/28/2009	302A-1116, HRS	79997	Dist Off Tchr	Certificated	T02	05	T	N	1.00	\$33,562	Y	N
EDN150	7/1/2009	302A-1116, HRS	79999	12-Mo Dist Off Tchr	Certificated	T02	05	T	N	1.00	\$63,408	Y	N
EDN150	7/27/2010	302A-1116, HRS	600537	Dist Off Tchr	Certificated	T02	05	T	A	1.00	\$55,916	N	N
EDN150	7/27/2010	302A-1116, HRS	600539	Dist Off Tchr	Certificated	T02	05	T	A	1.00	\$55,916	Y	N
EDN150	7/27/2010	302A-1116, HRS	600540	12-Mo Dist Off Tchr	Certificated	T02	05	T	A	1.00	\$55,916	N	N
EDN150	7/27/2010	302A-1116, HRS	600541	Dist Off Tchr	Certificated	T02	05	T	A	1.00	\$55,916	N	N
EDN150	7/27/2010	302A-1116, HRS	600542	Dist Off Tchr	Certificated	T02	05	T	A	1.00	\$55,916	Y	N
EDN150	7/27/2010	302A-1116, HRS	600543	Dist Off Tchr	Certificated	T02	05	T	A	1.00	\$55,916	N	N
EDN150	7/27/2010	302A-1116, HRS	600551	Dist Off Tchr	Certificated	T02	05	T	N	1.00	\$48,384	Y	N
EDN150	7/27/2010	302A-1116, HRS	600552	Dist Off Tchr	Certificated	T02	05	T	A	1.00	\$55,916	Y	N
EDN150	7/27/2010	302A-1116, HRS	600554	Dist Off Tchr	Certificated	T02	05	T	N	1.00	\$69,880	Y	N
EDN150	7/27/2010	302A-1116, HRS	600555	Dist Off Tchr	Certificated	T02	05	T	N	1.00	\$52,072	Y	N
EDN150	7/27/2010	302A-1116, HRS	600556	Dist Off Tchr	Certificated	T02	05	T	N	1.00	\$49,837	Y	N
EDN150	7/27/2010	302A-1116, HRS	600605	Dist Off Tchr	Certificated	T02	05	T	N	1.00	\$31,077	Y	N
EDN150	7/27/2010	302A-1116, HRS	600606	Dist Off Tchr	Certificated	T02	05	T	N	1.00	\$44,278	Y	N
EDN150	7/27/2010	302A-1116, HRS	600607	Dist Off Tchr	Certificated	T02	05	T	N	1.00	\$44,278	Y	N
EDN150	7/1/2010	302A-1116, HRS	600789	12-Mo Dist Off Tchr	Certificated	T02	05	T	A	1.00	\$55,916	Y	N

Department of Education
Unappropriated Positions as of June 28, 2013

Table 17

<u>Prog ID</u>	<u>Date Established</u>	<u>Legal Authority</u>	<u>Position Number</u>	<u>Position Title</u>	<u>Exempt (Y/N)</u>	<u>SR Level</u>	<u>BU Code</u>	<u>T/P</u>	<u>MOF</u>	<u>FTE</u>	<u>Annual Salary</u>	<u>Filled (Y/N)</u>	<u>Occupied by 89 Day Hire (Y/N)</u>
EDN150	7/1/2010	302A-1116, HRS	600790	12-Mo Dist Off Tchr	Certificated	T02	05	T	A	1.00	\$55,916	Y	N
EDN150	8/3/2010	302A-1116, HRS	600815	Dist Off Tchr	Certificated	T02	05	T	N	1.00	\$44,278	Y	N
EDN150	9/24/2010	302A-1116, HRS	600918	12-Mo Dist Off Tchr	Certificated	T02	05	T	A	1.00	\$55,916	Y	N
EDN150	9/24/2010	302A-1116, HRS	600919	12-Mo Dist Off Tchr	Certificated	T02	05	T	A	1.00	\$55,916	N	N
EDN150	9/1/2010	302A-1116, HRS	600922	District Educ Spec II	Certificated	E07	06	T	N	1.00	\$73,216	N	N
EDN150	10/25/2010	302A-1116, HRS	600960	Dist Off Tchr	Certificated	T02	05	T	N	1.00	\$50,808	Y	N
EDN150	10/29/2010	302A-1116, HRS	600983	Dist Off Tchr	Certificated	T02	05	T	A	1.00	\$44,278	Y	N
EDN150	10/29/2010	302A-1116, HRS	600984	Dist Off Tchr	Certificated	T02	05	T	A	1.00	\$40,999	N	N
EDN150	11/8/2010	302A-1116, HRS	600985	12-Mo Dist Off Tchr	Certificated	T02	05	T	A	1.00	\$40,999	N	N
EDN150	1/4/2011	302A-1116, HRS	601169	12-Mo Dist Off Tchr	Certificated	T02	05	T	A	1.00	\$55,916	N	N
EDN150	3/14/2011	302A-1116, HRS	602005	Dist Off Tchr	Certificated	T02	05	T	N	1.00	\$45,607	Y	N
EDN150	7/26/2011	302A-1116, HRS	602306	Dist Off Tchr	Certificated	T02	05	T	N	1.00	\$40,999	N	N
EDN150	9/15/2011	302A-1116, HRS	602444	12-Mo Dist Off Tchr	Certificated	T02	05	T	N	1.00	\$53,133	Y	N
EDN150	1/25/2012	302A-1116, HRS	602620	12-Mo State Off Tchr	Certificated	T02	05	T	N	1.00	\$55,259	Y	N
EDN150	1/25/2012	302A-1116, HRS	602621	12-Mo State Off Tchr	Certificated	T02	05	T	N	1.00	\$69,231	Y	N
EDN150	1/25/2012	302A-1116, HRS	602622	12-Mo State Off Tchr	Certificated	T02	05	T	N	1.00	\$60,970	Y	N
EDN150	7/1/2012	302A-1116, HRS	603160	12-Mo Dist Off Tchr	Certificated	T02	05	T	N	1.00	\$69,231	Y	N
EDN150	2/16/2012	302A-1116, HRS	603161	Dist Off Tchr	Certificated	T02	05	T	A	1.00	\$55,916	N	N
EDN150	7/24/2012	302A-1116, HRS	603166	Dist Off Tchr	Certificated	T02	05	T	N	1.00	\$40,999	N	N
EDN150	7/1/2012	302A-1116, HRS	603168	12-Mo Dist Off Tchr	Certificated	T02	05	T	N	1.00	\$53,133	Y	N
EDN150	7/1/2012	302A-1116, HRS	603171	12-Mo Dist Off Tchr	Certificated	T02	05	T	A	1.00	\$58,625	Y	N
EDN150	7/1/2012	302A-1116, HRS	603172	12-Mo Dist Off Tchr	Certificated	T02	05	T	A	1.00	\$68,622	Y	N
EDN150	7/1/2012	302A-1116, HRS	603173	12-Mo Dist Off Tchr	Certificated	T02	05	T	A	1.00	\$55,916	Y	N
EDN150	7/1/2012	302A-1116, HRS	603221	Dist Off Tchr	Certificated	T02	05	T	N	1.00	\$40,999	N	N
EDN150	7/1/2012	302A-1116, HRS	603222	Dist Off Tchr	Certificated	T02	05	T	N	1.00	\$40,999	Y	N
EDN150	7/1/2012	302A-1116, HRS	603232	12-Mo Dist Off Tchr	Certificated	T02	05	T	N	1.00	\$49,198	Y	N
EDN150	7/1/2012	302A-1116, HRS	603233	12-Mo Dist Off Tchr	Certificated	T02	05	T	N	1.00	\$63,355	Y	N
EDN150	7/24/2012	302A-1116, HRS	603240	Dist Off Tchr	Certificated	T02	05	T	N	1.00	\$44,278	Y	N
EDN150	7/24/2012	302A-1116, HRS	603307	Dist Off Tchr	Certificated	T02	05	T	N	1.00	\$61,257	Y	N
EDN150	6/12/2012	302A-1116, HRS	603426	District Educ Spec II	Certificated	E07	06	T	N	1.00	\$73,216	Y	N
EDN150	7/24/2012	302A-1116, HRS	603476	Dist Off Tchr	Certificated	T02	05	T	N	1.00	\$40,999	N	N
EDN150	7/24/2012	302A-1116, HRS	603513	Dist Off Tchr	Certificated	T02	05	T	N	1.00	\$64,933	Y	N
EDN150	7/24/2012	302A-1116, HRS	603514	Dist Off Tchr	Certificated	T02	05	T	N	1.00	\$59,422	Y	N
EDN150	7/24/2012	302A-1116, HRS	603516	Dist Off Tchr	Certificated	T02	05	T	N	0.50	\$20,500	N	N
EDN150	7/24/2012	302A-1116, HRS	603548	Dist Off Tchr	Certificated	T02	05	T	N	1.00	\$44,278	Y	N
EDN150	7/24/2012	302A-1116, HRS	603549	Dist Off Tchr	Certificated	T02	05	T	N	1.00	\$48,384	Y	N
EDN150	9/28/2004	302A-1116, HRS	800066	Educ Asst III	Y	SR12	03	T	N	1.00	\$22,941	Y	N
EDN150	12/8/2004	302A-1116, HRS	800174	Educ Asst III	Y	SR12	03	T	N	1.00	\$24,824	Y	N
EDN150	12/8/2004	302A-1116, HRS	800176	Educ Asst III	Y	SR12	03	T	N	1.00	\$22,941	Y	N
EDN150	12/8/2004	302A-1116, HRS	800177	Educ Asst III	Y	SR12	03	T	N	1.00	\$22,941	Y	N
EDN150	12/8/2004	302A-1116, HRS	800179	Educ Asst III	Y	SR12	03	T	N	1.00	\$28,534	N	N
EDN150	12/8/2004	302A-1116, HRS	800181	Educ Asst III	Y	SR12	03	T	N	1.00	\$28,534	N	N
EDN150	12/8/2004	302A-1116, HRS	800182	Educ Asst III	Y	SR12	03	T	N	1.00	\$28,534	Y	N
EDN150	12/8/2004	302A-1116, HRS	800183	Educ Asst III	Y	SR12	03	T	N	1.00	\$24,824	N	N
EDN150	9/1/2005	302A-1116, HRS	800357	Educ Asst III	Y	SR12	03	T	N	1.00	\$25,796	Y	N

Department of Education
Unappropriated Positions as of June 28, 2013

Table 17

<u>Prog ID</u>	<u>Date Established</u>	<u>Legal Authority</u>	<u>Position Number</u>	<u>Position Title</u>	<u>Exempt (Y/N)</u>	<u>SR Level</u>	<u>BU Code</u>	<u>T/P</u>	<u>MOF</u>	<u>FTE</u>	<u>Annual Salary</u>	<u>Filled (Y/N)</u>	<u>Occupied by 89 Day Hire (Y/N)</u>
EDN150	9/1/2005	302A-1116, HRS	800359	Educ Asst III	Y	SR12	03	T	N	1.00	\$26,799	Y	N
EDN150	9/1/2005	302A-1116, HRS	800360	Educ Asst III	Y	SR12	03	T	N	1.00	\$28,534	N	N
EDN150	9/1/2005	302A-1116, HRS	800361	Educ Asst III	Y	SR12	03	T	N	1.00	\$22,941	N	N
EDN150	9/1/2005	302A-1116, HRS	800362	Educ Asst III	Y	SR12	03	T	N	1.00	\$22,941	Y	N
EDN150	9/1/2005	302A-1116, HRS	800364	Educ Asst III	Y	SR12	03	T	N	1.00	\$28,981	Y	N
EDN150	9/1/2005	302A-1116, HRS	800365	Educ Asst III	Y	SR12	03	T	N	1.00	\$24,824	Y	N
EDN150	10/12/2010	302A-1116, HRS	800499	Educ Asst III	Y	SR12	03	T	N	1.00	\$28,534	Y	N
EDN150	9/1/2006	302A-1116, HRS	800504	Educ Asst III	Y	SR12	03	T	N	1.00	\$28,534	N	N
EDN150	7/25/2006	302A-1116, HRS	800507	Educ Asst III	Y	SR12	03	T	N	1.00	\$36,706	Y	N
EDN150	11/2/2006	302A-1116, HRS	800560	Educ Asst III	Y	SR12	03	T	N	1.00	\$26,799	Y	N
EDN150	11/2/2006	302A-1116, HRS	800561	Educ Asst III	Y	SR12	03	T	N	1.00	\$24,824	Y	N
EDN150	1/25/2007	302A-1116, HRS	800599	Communication Aide	Y	SR12	03	T	N	0.75	\$20,099	Y	N
EDN150	4/9/2007	302A-1116, HRS	800627	Educ Asst III	Y	SR12	03	T	N	1.00	\$28,534	N	N
EDN150	5/24/2007	302A-1116, HRS	800660	Educ Asst III	Y	SR12	03	T	N	1.00	\$28,534	N	N
EDN150	7/1/2011	302A-1116, HRS	800674	Educ Asst III	Y	SR12	03	T	N	0.75	\$21,401	N	N
EDN150	8/29/2007	302A-1116, HRS	800831	Educ Asst III	Y	SR12	03	T	A	1.00	\$28,534	N	N
EDN150	8/29/2007	302A-1116, HRS	800832	Educ Asst III	Y	SR12	03	T	A	1.00	\$24,824	Y	N
EDN150	8/29/2007	302A-1116, HRS	800834	Educ Asst III	Y	SR12	03	T	A	1.00	\$24,824	Y	N
EDN150	8/29/2007	302A-1116, HRS	800835	Educ Asst III	Y	SR12	03	T	A	1.00	\$24,824	Y	N
EDN150	8/29/2007	302A-1116, HRS	800839	Educ Asst III	Y	SR12	03	T	A	1.00	\$24,824	Y	N
EDN150	9/4/2007	302A-1116, HRS	800853	Office Assistant III	N	SR08	03	T	A	1.00	\$25,668	N	N
EDN150	11/1/2012	302A-1116, HRS	800979	Prgm Spclt IV	N	SR22	13	T	N	0.50	\$21,649	Y	N
EDN150	1/28/2008	302A-1116, HRS	800990	Educ Asst III	Y	SR12	03	T	N	1.00	\$24,824	Y	N
EDN150	2/5/2008	302A-1116, HRS	800997	Educ Asst III	Y	SR12	03	T	N	1.00	\$28,534	N	N
EDN150	2/1/2011	302A-1116, HRS	801000	Secretary II	N	SR14	03	T	A	1.00	\$32,424	Y	N
EDN150	4/1/2008	302A-1116, HRS	801027	Educ Asst III	Y	SR12	03	T	N	1.00	\$24,824	N	N
EDN150	5/28/2008	302A-1116, HRS	801071	Educ Asst III	Y	SR12	03	T	A	1.00	\$28,534	Y	Y
EDN150	5/28/2008	302A-1116, HRS	801072	Educ Asst III	Y	SR12	03	T	A	1.00	\$28,534	N	N
EDN150	5/28/2008	302A-1116, HRS	801073	Educ Asst III	Y	SR12	03	T	A	1.00	\$28,534	Y	Y
EDN150	7/14/2008	302A-1116, HRS	801132	Educ Asst III	Y	SR12	03	T	N	1.00	\$24,824	Y	N
EDN150	7/25/2008	302A-1116, HRS	801162	Educ Asst III	Y	SR12	03	T	N	1.00	\$28,534	N	N
EDN150	10/12/2010	302A-1116, HRS	801218	Educ Asst III	Y	SR12	03	T	N	1.00	\$28,534	N	N
EDN150	5/26/2009	302A-1116, HRS	801356	Educ Asst III	Y	SR12	03	T	N	1.00	\$28,534	N	N
EDN150	10/12/2009	302A-1116, HRS	801457	Educ Asst III	Y	SR12	03	T	N	1.00	\$22,941	Y	N
EDN150	4/9/2010	302A-1116, HRS	801520	Educ Asst III	Y	SR12	03	T	A	1.00	\$30,036	Y	N
EDN150	4/9/2010	302A-1116, HRS	801521	Educ Asst III	Y	SR12	03	T	A	1.00	\$30,036	N	N
EDN150	4/9/2010	302A-1116, HRS	801522	Educ Asst III	Y	SR12	03	T	A	1.00	\$30,036	Y	N
EDN150	4/9/2010	302A-1116, HRS	801523	Educ Asst III	Y	SR12	03	T	A	1.00	\$30,036	Y	N
EDN150	4/9/2010	302A-1116, HRS	801524	Educ Asst III	Y	SR12	03	T	A	1.00	\$30,036	N	N
EDN150	4/9/2010	302A-1116, HRS	801525	Educ Asst III	Y	SR12	03	T	A	1.00	\$30,036	N	N
EDN150	4/9/2010	302A-1116, HRS	801526	Educ Asst III	Y	SR12	03	T	A	1.00	\$30,036	Y	N
EDN150	4/9/2010	302A-1116, HRS	801527	Educ Asst III	Y	SR12	03	T	A	1.00	\$30,036	Y	N
EDN150	4/9/2010	302A-1116, HRS	801528	Educ Asst III	Y	SR12	03	T	A	1.00	\$30,036	N	N
EDN150	4/9/2010	302A-1116, HRS	801529	Educ Asst III	Y	SR12	03	T	A	1.00	\$30,036	N	N
EDN150	4/14/2010	302A-1116, HRS	801532	Behavioral Hlth Spclt IV	N	SR22	13	T	A	1.00	\$44,412	Y	N

Department of Education
Unappropriated Positions as of June 28, 2013

Table 17

<u>Prog ID</u>	<u>Date Established</u>	<u>Legal Authority</u>	<u>Position Number</u>	<u>Position Title</u>	<u>Exempt (Y/N)</u>	<u>SR Level</u>	<u>BU Code</u>	<u>T/P</u>	<u>MOF</u>	<u>FTE</u>	<u>Annual Salary</u>	<u>Filled (Y/N)</u>	<u>Occupied by 89 Day Hire (Y/N)</u>
EDN150	7/1/2010	302A-1116, HRS	801553	Educ Asst III	Y	SR12	03	T	N	1.00	\$24,824	Y	N
EDN150	7/1/2010	302A-1116, HRS	801554	Educ Asst III	Y	SR12	03	T	N	1.00	\$28,534	N	N
EDN150	8/12/2010	302A-1116, HRS	801633	Educ Asst III	Y	SR12	03	T	N	1.00	\$24,824	Y	N
EDN150	8/27/2010	302A-1116, HRS	801668	Behavioral Hlth Spclt IV	N	SR22	13	T	A	1.00	\$44,412	N	N
EDN150	8/27/2010	302A-1116, HRS	801669	Behavioral Hlth Spclt IV	N	SR22	13	T	A	1.00	\$44,412	N	N
EDN150	8/27/2010	302A-1116, HRS	801670	Behavioral Hlth Spclt IV	N	SR22	13	T	A	1.00	\$44,412	Y	N
EDN150	8/31/2010	302A-1116, HRS	801677	Speech Pathologist IV	Y	SR22	13	T	A	1.00	\$44,412	Y	N
EDN150	9/14/2010	302A-1116, HRS	801702	Educ Asst III	Y	SR12	03	T	A	1.00	\$30,036	Y	N
EDN150	9/14/2010	302A-1116, HRS	801703	Educ Asst III	Y	SR12	03	T	A	1.00	\$30,036	N	N
EDN150	9/14/2010	302A-1116, HRS	801704	Educ Asst III	Y	SR12	03	T	A	1.00	\$30,036	Y	Y
EDN150	9/14/2010	302A-1116, HRS	801705	Educ Asst III	Y	SR12	03	T	A	1.00	\$30,036	Y	Y
EDN150	9/14/2010	302A-1116, HRS	801706	Educ Asst III	Y	SR12	03	T	A	1.00	\$30,036	Y	N
EDN150	9/14/2010	302A-1116, HRS	801707	Educ Asst III	Y	SR12	03	T	A	1.00	\$30,036	Y	N
EDN150	9/14/2010	302A-1116, HRS	801708	Educ Asst III	Y	SR12	03	T	A	1.00	\$30,036	Y	N
EDN150	9/14/2010	302A-1116, HRS	801709	Educ Asst III	Y	SR12	03	T	A	1.00	\$30,036	Y	N
EDN150	9/14/2010	302A-1116, HRS	801710	Educ Asst III	Y	SR12	03	T	A	1.00	\$30,036	Y	N
EDN150	9/14/2010	302A-1116, HRS	801711	Educ Asst III	Y	SR12	03	T	A	1.00	\$25,704	Y	N
EDN150	9/14/2010	302A-1116, HRS	801713	Educ Asst III	Y	SR12	03	T	A	1.00	\$28,534	N	N
EDN150	9/14/2010	302A-1116, HRS	801714	Educ Asst III	Y	SR12	03	T	A	1.00	\$28,534	N	N
EDN150	9/14/2010	302A-1116, HRS	801715	Educ Asst III	Y	SR12	03	T	A	1.00	\$30,036	Y	N
EDN150	9/14/2010	302A-1116, HRS	801716	Educ Asst III	Y	SR12	03	T	A	1.00	\$30,036	Y	N
EDN150	9/14/2010	302A-1116, HRS	801717	Educ Asst III	Y	SR12	03	T	A	1.00	\$30,036	N	N
EDN150	9/14/2010	302A-1116, HRS	801718	Educ Asst III	Y	SR12	03	T	A	1.00	\$28,534	Y	Y
EDN150	9/14/2010	302A-1116, HRS	801719	Educ Asst III	Y	SR12	03	T	A	1.00	\$28,534	Y	Y
EDN150	9/14/2010	302A-1116, HRS	801720	Educ Asst III	Y	SR12	03	T	A	1.00	\$28,534	Y	Y
EDN150	9/15/2010	302A-1116, HRS	801729	Educ Asst III	Y	SR12	03	T	A	1.00	\$30,036	N	N
EDN150	9/15/2010	302A-1116, HRS	801730	Educ Asst III	Y	SR12	03	T	A	1.00	\$30,036	N	N
EDN150	9/15/2010	302A-1116, HRS	801731	Educ Asst III	Y	SR12	03	T	A	1.00	\$30,036	N	N
EDN150	9/15/2010	302A-1116, HRS	801732	Educ Asst III	Y	SR12	03	T	A	1.00	\$30,036	Y	N
EDN150	9/15/2010	302A-1116, HRS	801733	Educ Asst III	Y	SR12	03	T	A	1.00	\$30,036	Y	N
EDN150	9/15/2010	302A-1116, HRS	801734	Educ Asst III	Y	SR12	03	T	A	1.00	\$30,036	N	N
EDN150	9/15/2010	302A-1116, HRS	801735	Educ Asst III	Y	SR12	03	T	A	1.00	\$30,036	Y	N
EDN150	9/15/2010	302A-1116, HRS	801736	Educ Asst III	Y	SR12	03	T	A	1.00	\$30,036	N	N
EDN150	9/15/2010	302A-1116, HRS	801737	Educ Asst III	Y	SR12	03	T	A	1.00	\$30,036	N	N
EDN150	9/15/2010	302A-1116, HRS	801738	Educ Asst III	Y	SR12	03	T	A	1.00	\$30,036	Y	N
EDN150	9/27/2010	302A-1116, HRS	801743	Educ Asst III	Y	SR12	03	T	N	0.75	\$21,401	Y	N
EDN150	7/27/2010	302A-1116, HRS	801744	Educ Asst III	Y	SR12	03	T	N	0.75	\$21,401	N	N
EDN150	9/27/2010	302A-1116, HRS	801745	Educ Asst III	Y	SR12	03	T	N	0.75	\$21,401	N	N
EDN150	9/27/2010	302A-1116, HRS	801746	Educ Asst III	Y	SR12	03	T	N	0.75	\$21,401	N	N
EDN150	9/27/2010	302A-1116, HRS	801749	Educ Asst III	Y	SR12	03	T	N	0.75	\$21,401	N	N
EDN150	9/27/2010	302A-1116, HRS	801751	Educ Asst III	Y	SR12	03	T	N	0.75	\$17,205	Y	N
EDN150	9/27/2010	302A-1116, HRS	801754	Educ Asst III	Y	SR12	03	T	N	0.75	\$17,205	Y	N
EDN150	9/27/2010	302A-1116, HRS	801755	Educ Asst III	Y	SR12	03	T	N	0.75	\$21,401	N	N
EDN150	9/27/2010	302A-1116, HRS	801756	Educ Asst III	Y	SR12	03	T	N	0.75	\$21,401	N	N
EDN150	9/27/2010	302A-1116, HRS	801757	Educ Asst III	Y	SR12	03	T	N	0.75	\$21,401	N	N

Department of Education
Unappropriated Positions as of June 28, 2013

Table 17

<u>Prog ID</u>	<u>Date Established</u>	<u>Legal Authority</u>	<u>Position Number</u>	<u>Position Title</u>	<u>Exempt (Y/N)</u>	<u>SR Level</u>	<u>BU Code</u>	<u>T/P</u>	<u>MOF</u>	<u>FTE</u>	<u>Annual Salary</u>	<u>Filled (Y/N)</u>	<u>Occupied by 89 Day Hire (Y/N)</u>
EDN150	9/27/2010	302A-1116, HRS	801761	Educ Asst III	Y	SR12	03	T	N	0.75	\$18,619	Y	N
EDN150	9/27/2010	302A-1116, HRS	801771	Educ Asst III	Y	SR12	03	T	N	0.75	\$18,619	N	N
EDN150	9/27/2010	302A-1116, HRS	801772	Educ Asst III	Y	SR12	03	T	N	0.75	\$21,401	N	N
EDN150	9/27/2010	302A-1116, HRS	801773	Educ Asst III	Y	SR12	03	T	N	0.75	\$21,401	N	N
EDN150	9/27/2010	302A-1116, HRS	801774	Educ Asst III	Y	SR12	03	T	N	0.75	\$21,401	N	N
EDN150	9/27/2010	302A-1116, HRS	801783	Educ Asst III	Y	SR12	03	T	N	1.00	\$28,534	N	N
EDN150	9/27/2010	302A-1116, HRS	801784	Educ Asst III	Y	SR12	03	T	N	1.00	\$24,824	Y	N
EDN150	10/4/2010	302A-1116, HRS	801795	Educ Asst III	Y	SR12	03	T	A	1.00	\$30,036	N	N
EDN150	10/4/2010	302A-1116, HRS	801796	Educ Asst III	Y	SR12	03	T	A	1.00	\$28,534	Y	N
EDN150	10/7/2010	302A-1116, HRS	801800	Behavioral Hlth Spclt V	N	SR24	13	T	A	1.00	\$48,048	Y	N
EDN150	10/29/2010	302A-1116, HRS	801810	Office Assistant III	N	SR08	03	T	A	1.00	\$25,668	Y	N
EDN150	10/29/2010	302A-1116, HRS	801811	Office Assistant III	N	SR08	03	T	A	1.00	\$25,668	Y	N
EDN150	11/9/2010	302A-1116, HRS	801817	Social Worker IV	N	SR22	13	T	A	1.00	\$43,297	Y	Y
EDN150	11/12/2010	302A-1116, HRS	801831	Educ Asst III	Y	SR12	03	T	A	1.00	\$28,534	N	N
EDN150	11/12/2010	302A-1116, HRS	801832	Educ Asst III	Y	SR12	03	T	A	1.00	\$28,534	Y	N
EDN150	11/12/2010	302A-1116, HRS	801833	Educ Asst III	Y	SR12	03	T	A	1.00	\$28,534	N	N
EDN150	11/12/2010	302A-1116, HRS	801834	Educ Asst III	Y	SR12	03	T	A	1.00	\$26,368	Y	N
EDN150	11/12/2010	302A-1116, HRS	801835	Educ Asst III	Y	SR12	03	T	A	1.00	\$28,534	Y	Y
EDN150	11/12/2010	302A-1116, HRS	801836	Educ Asst III	Y	SR12	03	T	A	1.00	\$28,534	Y	Y
EDN150	11/12/2010	302A-1116, HRS	801837	Educ Asst III	Y	SR12	03	T	A	1.00	\$28,534	N	N
EDN150	11/18/2010	302A-1116, HRS	801848	Educ Asst III	Y	SR12	03	T	A	1.00	\$28,534	N	N
EDN150	11/18/2010	302A-1116, HRS	801849	Educ Asst III	Y	SR12	03	T	A	1.00	\$24,824	Y	N
EDN150	11/18/2010	302A-1116, HRS	801850	Educ Asst III	Y	SR12	03	T	A	1.00	\$24,824	Y	N
EDN150	11/18/2010	302A-1116, HRS	801851	Educ Asst III	Y	SR12	03	T	A	1.00	\$24,824	Y	N
EDN150	11/18/2010	302A-1116, HRS	801852	Educ Asst III	Y	SR12	03	T	A	1.00	\$28,534	N	N
EDN150	11/18/2010	302A-1116, HRS	801853	Educ Asst III	Y	SR12	03	T	A	1.00	\$28,534	N	N
EDN150	11/18/2010	302A-1116, HRS	801854	Educ Asst III	Y	SR12	03	T	A	1.00	\$24,824	Y	N
EDN150	11/18/2010	302A-1116, HRS	801855	Educ Asst III	Y	SR12	03	T	A	1.00	\$28,534	N	N
EDN150	11/18/2010	302A-1116, HRS	801856	Educ Asst III	Y	SR12	03	T	A	1.00	\$24,824	Y	N
EDN150	11/18/2010	302A-1116, HRS	801857	Educ Asst III	Y	SR12	03	T	A	1.00	\$28,534	N	N
EDN150	11/18/2010	302A-1116, HRS	801858	Educ Asst III	Y	SR12	03	T	A	1.00	\$28,534	N	N
EDN150	11/18/2010	302A-1116, HRS	801859	Educ Asst III	Y	SR12	03	T	A	1.00	\$24,824	Y	N
EDN150	11/18/2010	302A-1116, HRS	801860	Educ Asst III	Y	SR12	03	T	A	1.00	\$24,824	Y	N
EDN150	11/18/2010	302A-1116, HRS	801861	Educ Asst III	Y	SR12	03	T	A	1.00	\$24,824	Y	N
EDN150	11/18/2010	302A-1116, HRS	801862	Educ Asst III	Y	SR12	03	T	A	1.00	\$28,534	Y	N
EDN150	11/18/2010	302A-1116, HRS	801863	Educ Asst III	Y	SR12	03	T	A	1.00	\$22,941	Y	N
EDN150	11/18/2010	302A-1116, HRS	801864	Educ Asst III	Y	SR12	03	T	A	1.00	\$28,534	N	N
EDN150	11/18/2010	302A-1116, HRS	801865	Educ Asst III	Y	SR12	03	T	A	1.00	\$24,824	Y	N
EDN150	11/18/2010	302A-1116, HRS	801866	Educ Asst III	Y	SR12	03	T	A	1.00	\$24,824	Y	N
EDN150	11/18/2010	302A-1116, HRS	801867	Educ Asst III	Y	SR12	03	T	A	1.00	\$24,824	Y	N
EDN150	11/16/2010	302A-1116, HRS	801868	Educ Asst III	Y	SR12	03	T	A	1.00	\$30,036	Y	N
EDN150	11/16/2010	302A-1116, HRS	801869	Educ Asst III	Y	SR12	03	T	A	1.00	\$30,036	Y	N
EDN150	11/16/2010	302A-1116, HRS	801870	Educ Asst III	Y	SR12	03	T	A	1.00	\$30,036	Y	N
EDN150	11/16/2010	302A-1116, HRS	801871	Educ Asst III	Y	SR12	03	T	A	1.00	\$30,036	Y	Y
EDN150	11/16/2010	302A-1116, HRS	801872	Educ Asst III	Y	SR12	03	T	A	1.00	\$30,036	Y	N

<u>Prog ID</u>	<u>Date Established</u>	<u>Legal Authority</u>	<u>Position Number</u>	<u>Position Title</u>	<u>Exempt (Y/N)</u>	<u>SR Level</u>	<u>BU Code</u>	<u>T/P</u>	<u>MOF</u>	<u>FTE</u>	<u>Annual Salary</u>	<u>Filled (Y/N)</u>	<u>Occupied by 89 Day Hire (Y/N)</u>
EDN150	11/16/2010	302A-1116, HRS	801873	Educ Asst III	Y	SR12	03	T	A	1.00	\$30,036	N	N
EDN150	11/16/2010	302A-1116, HRS	801874	Educ Asst III	Y	SR12	03	T	A	1.00	\$30,036	Y	Y
EDN150	11/16/2010	302A-1116, HRS	801875	Educ Asst III	Y	SR12	03	T	A	1.00	\$30,036	Y	Y
EDN150	11/16/2010	302A-1116, HRS	801876	Educ Asst III	Y	SR12	03	T	A	1.00	\$30,036	Y	Y
EDN150	11/16/2010	302A-1116, HRS	801877	Educ Asst III	Y	SR12	03	T	A	1.00	\$30,036	Y	N
EDN150	11/16/2010	302A-1116, HRS	801878	Educ Asst III	Y	SR12	03	T	A	1.00	\$30,036	Y	N
EDN150	11/16/2010	302A-1116, HRS	801879	Educ Asst III	Y	SR12	03	T	A	1.00	\$30,036	Y	Y
EDN150	11/16/2010	302A-1116, HRS	801880	Educ Asst III	Y	SR12	03	T	A	1.00	\$30,036	Y	Y
EDN150	11/16/2010	302A-1116, HRS	801881	Educ Asst III	Y	SR12	03	T	A	1.00	\$30,036	Y	N
EDN150	11/16/2010	302A-1116, HRS	801882	Educ Asst III	Y	SR12	03	T	A	1.00	\$30,036	Y	N
EDN150	11/15/2010	302A-1116, HRS	801883	Educ Asst III	Y	SR12	03	T	A	1.00	\$30,036	Y	N
EDN150	12/8/2010	302A-1116, HRS	801941	School Psychologist	Y	SR24	13	T	A	1.00	\$48,048	Y	Y
EDN150	3/30/2011	302A-1116, HRS	802071	Behavioral Hlth Spclt IV	N	SR22	13	T	A	1.00	\$44,412	Y	N
EDN150	7/1/2011	302A-1116, HRS	802111	Secretary II	N	SR14	03	T	N	1.00	\$47,435	Y	N
EDN150	7/1/2011	302A-1116, HRS	802152	Secretary II	N	SR14	03	T	N	1.00	\$40,550	Y	N
EDN150	5/16/2011	302A-1116, HRS	802153	Educ Asst III	Y	SR12	03	T	A	1.00	\$30,036	N	N
EDN150	5/16/2011	302A-1116, HRS	802154	Educ Asst III	Y	SR12	03	T	A	1.00	\$30,036	N	N
EDN150	5/16/2011	302A-1116, HRS	802155	Educ Asst III	Y	SR12	03	T	A	1.00	\$30,036	N	N
EDN150	5/16/2011	302A-1116, HRS	802156	Educ Asst III	Y	SR12	03	T	A	1.00	\$30,036	N	N
EDN150	5/16/2011	302A-1116, HRS	802157	Educ Asst III	Y	SR12	03	T	A	1.00	\$30,036	N	N
EDN150	5/16/2011	302A-1116, HRS	802158	Educ Asst III	Y	SR12	03	T	A	1.00	\$30,036	N	N
EDN150	5/16/2011	302A-1116, HRS	802159	Educ Asst III	Y	SR12	03	T	A	1.00	\$30,036	Y	N
EDN150	5/16/2011	302A-1116, HRS	802160	Educ Asst III	Y	SR12	03	T	A	1.00	\$30,036	N	N
EDN150	5/16/2011	302A-1116, HRS	802161	Educ Asst III	Y	SR12	03	T	A	1.00	\$30,036	N	N
EDN150	5/16/2011	302A-1116, HRS	802162	Educ Asst III	Y	SR12	03	T	A	1.00	\$30,036	N	N
EDN150	7/1/2011	302A-1116, HRS	802177	Behavioral Hlth Spclt IV	N	SR22	13	T	A	1.00	\$44,412	N	N
EDN150	7/1/2011	302A-1116, HRS	802178	Behavioral Hlth Spclt IV	N	SR22	13	T	A	1.00	\$44,412	N	N
EDN150	7/1/2011	302A-1116, HRS	802179	Behavioral Hlth Spclt IV	N	SR22	13	T	A	1.00	\$44,412	N	N
EDN150	7/1/2011	302A-1116, HRS	802185	Behavioral Hlth Spclt V	N	SR24	13	T	A	1.00	\$48,048	Y	N
EDN150	7/1/2011	302A-1116, HRS	802186	Behavioral Hlth Spclt V	N	SR24	13	T	A	1.00	\$48,048	N	N
EDN150	7/1/2011	302A-1116, HRS	802187	Behavioral Hlth Spclt V	N	SR24	13	T	A	1.00	\$48,048	N	N
EDN150	6/8/2011	302A-1116, HRS	802216	Educ Asst III	Y	SR12	03	T	A	1.00	\$22,941	Y	N
EDN150	6/8/2011	302A-1116, HRS	802217	Educ Asst III	Y	SR12	03	T	A	1.00	\$22,941	Y	N
EDN150	6/8/2011	302A-1116, HRS	802218	Educ Asst III	Y	SR12	03	T	A	1.00	\$28,534	N	N
EDN150	6/8/2011	302A-1116, HRS	802219	Educ Asst III	Y	SR12	03	T	A	1.00	\$28,534	Y	Y
EDN150	6/8/2011	302A-1116, HRS	802220	Educ Asst III	Y	SR12	03	T	A	1.00	\$28,534	Y	Y
EDN150	3/18/2013	302A-1116, HRS	802221	Educ Asst III	Y	SR12	03	T	A	1.00	\$28,534	N	N
EDN150	7/1/2011	302A-1116, HRS	802222	Educ Asst III	Y	SR12	03	T	N	1.00	\$28,534	Y	Y
EDN150	7/1/2011	302A-1116, HRS	802223	Educ Asst III	Y	SR12	03	T	N	1.00	\$28,534	N	N
EDN150	7/1/2011	302A-1116, HRS	802281	Educ Asst III	Y	SR12	03	T	A	1.00	\$30,036	Y	N
EDN150	7/1/2011	302A-1116, HRS	802282	Educ Asst III	Y	SR12	03	T	A	1.00	\$30,036	Y	N
EDN150	7/1/2011	302A-1116, HRS	802283	Educ Asst III	Y	SR12	03	T	A	1.00	\$30,036	Y	N
EDN150	7/1/2011	302A-1116, HRS	802284	Educ Asst III	Y	SR12	03	T	A	1.00	\$30,036	Y	N
EDN150	7/1/2011	302A-1116, HRS	802285	Educ Asst III	Y	SR12	03	T	A	1.00	\$30,036	Y	N
EDN150	7/1/2011	302A-1116, HRS	802286	Educ Asst III	Y	SR12	03	T	A	1.00	\$30,036	Y	N

<u>Prog ID</u>	<u>Date Established</u>	<u>Legal Authority</u>	<u>Position Number</u>	<u>Position Title</u>	<u>Exempt (Y/N)</u>	<u>SR Level</u>	<u>BU Code</u>	<u>T/P</u>	<u>MOF</u>	<u>FTE</u>	<u>Annual Salary</u>	<u>Filled (Y/N)</u>	<u>Occupied by 89 Day Hire (Y/N)</u>
EDN150	7/1/2011	302A-1116, HRS	802287	Educ Asst III	Y	SR12	03	T	A	1.00	\$30,036	Y	N
EDN150	7/1/2011	302A-1116, HRS	802288	Educ Asst III	Y	SR12	03	T	A	1.00	\$30,036	Y	N
EDN150	7/1/2011	302A-1116, HRS	802289	Educ Asst III	Y	SR12	03	T	A	1.00	\$30,036	N	N
EDN150	7/1/2011	302A-1116, HRS	802290	Educ Asst III	Y	SR12	03	T	A	1.00	\$30,036	N	N
EDN150	7/27/2011	302A-1116, HRS	802305	School Security Attendant	N	SR07	03	T	A	1.00	\$20,372	Y	N
EDN150	9/27/2011	302A-1116, HRS	802339	Behavioral Hlth Spclt IV	N	SR22	13	T	N	1.00	\$43,297	N	N
EDN150	9/19/2011	302A-1116, HRS	802365	Behavioral Hlth Spclt IV	N	SR22	13	T	A	1.00	\$43,297	Y	N
EDN150	9/26/2011	302A-1116, HRS	802366	Behavioral Hlth Spclt IV	N	SR22	13	T	A	1.00	\$43,297	Y	Y
EDN150	9/26/2011	302A-1116, HRS	802367	Behavioral Hlth Spclt IV	N	SR22	13	T	A	1.00	\$43,297	Y	N
EDN150	9/26/2011	302A-1116, HRS	802368	Behavioral Hlth Spclt IV	N	SR22	13	T	A	1.00	\$43,297	Y	N
EDN150	9/30/2011	302A-1116, HRS	802369	School Psychologist	Y	SR24	13	T	A	1.00	\$48,048	Y	N
EDN150	9/30/2011	302A-1116, HRS	802370	School Psychologist	Y	SR24	13	T	A	1.00	\$48,048	Y	N
EDN150	9/27/2011	302A-1116, HRS	802371	Educ Asst III	Y	SR12	03	T	N	1.00	\$24,824	Y	N
EDN150	9/27/2011	302A-1116, HRS	802372	Educ Asst III	Y	SR12	03	T	N	1.00	\$28,534	N	N
EDN150	9/27/2011	302A-1116, HRS	802373	Educ Asst III	Y	SR12	03	T	N	1.00	\$28,534	N	N
EDN150	9/27/2011	302A-1116, HRS	802374	Educ Asst III	Y	SR12	03	T	N	1.00	\$28,534	N	N
EDN150	9/27/2011	302A-1116, HRS	802375	Educ Asst III	Y	SR12	03	T	A	1.00	\$24,824	Y	N
EDN150	9/27/2011	302A-1116, HRS	802376	Educ Asst III	Y	SR12	03	T	A	1.00	\$30,036	Y	Y
EDN150	9/27/2011	302A-1116, HRS	802377	Educ Asst III	Y	SR12	03	T	A	1.00	\$22,941	Y	N
EDN150	9/27/2011	302A-1116, HRS	802378	Educ Asst III	Y	SR12	03	T	A	1.00	\$24,824	Y	N
EDN150	9/27/2011	302A-1116, HRS	802379	Educ Asst III	Y	SR12	03	T	A	1.00	\$22,941	Y	N
EDN150	9/27/2011	302A-1116, HRS	802380	Educ Asst III	Y	SR12	03	T	A	1.00	\$30,036	Y	Y
EDN150	9/27/2011	302A-1116, HRS	802381	Educ Asst III	Y	SR12	03	T	A	1.00	\$30,036	Y	Y
EDN150	9/27/2011	302A-1116, HRS	802382	Educ Asst III	Y	SR12	03	T	A	1.00	\$28,534	Y	Y
EDN150	9/27/2011	302A-1116, HRS	802383	Educ Asst III	Y	SR12	03	T	A	1.00	\$30,036	Y	Y
EDN150	9/27/2011	302A-1116, HRS	802384	Educ Asst III	Y	SR12	03	T	A	1.00	\$30,036	Y	Y
EDN150	9/27/2011	302A-1116, HRS	802385	Educ Asst III	Y	SR12	03	T	A	1.00	\$30,036	Y	Y
EDN150	12/30/2011	302A-1116, HRS	802438	Office Assistant III	N	SR08	03	T	N	1.00	\$24,385	N	N
EDN150	12/6/2011	302A-1116, HRS	802443	Educ Asst III	Y	SR12	03	T	A	1.00	\$30,036	Y	N
EDN150	12/6/2011	302A-1116, HRS	802444	Educ Asst III	Y	SR12	03	T	A	1.00	\$30,036	Y	N
EDN150	12/6/2011	302A-1116, HRS	802445	Educ Asst III	Y	SR12	03	T	A	1.00	\$30,036	Y	N
EDN150	12/6/2011	302A-1116, HRS	802446	Educ Asst III	Y	SR12	03	T	A	1.00	\$30,036	Y	N
EDN150	12/6/2011	302A-1116, HRS	802447	Educ Asst III	Y	SR12	03	T	A	1.00	\$30,036	Y	N
EDN150	12/20/2011	302A-1116, HRS	802449	Educ Asst III	Y	SR12	03	T	N	1.00	\$28,534	Y	Y
EDN150	12/20/2011	302A-1116, HRS	802450	Educ Asst III	Y	SR12	03	T	N	1.00	\$28,534	N	N
EDN150	12/20/2011	302A-1116, HRS	802451	Educ Asst III	Y	SR12	03	T	N	1.00	\$22,941	N	N
EDN150	12/20/2011	302A-1116, HRS	802452	Educ Asst III	Y	SR12	03	T	N	1.00	\$28,534	Y	Y
EDN150	12/30/2011	302A-1116, HRS	802469	Clinical Psychologist VI	N	SR26	13	T	N	1.00	\$57,707	Y	N
EDN150	1/5/2012	302A-1116, HRS	802471	Behavioral Hlth Spclt IV	N	SR22	13	T	N	1.00	\$40,025	Y	N
EDN150	1/26/2012	302A-1116, HRS	802474	Educ Asst III	Y	SR12	03	T	N	1.00	\$22,941	Y	N
EDN150	2/13/2012	302A-1116, HRS	802483	Educ Asst III	Y	SR12	03	T	N	1.00	\$28,534	N	N
EDN150	2/6/2012	302A-1116, HRS	802485	Educ Asst III	Y	SR12	03	T	N	1.00	\$28,534	N	N
EDN150	2/6/2012	302A-1116, HRS	802486	Educ Asst III	Y	SR12	03	T	N	1.00	\$22,941	Y	N
EDN150	2/6/2012	302A-1116, HRS	802487	Educ Asst III	Y	SR12	03	T	N	1.00	\$24,824	Y	N
EDN150	2/28/2012	302A-1116, HRS	802511	Educ Asst III	Y	SR12	03	T	N	1.00	\$28,534	N	N

<u>Prog ID</u>	<u>Date Established</u>	<u>Legal Authority</u>	<u>Position Number</u>	<u>Position Title</u>	<u>Exempt (Y/N)</u>	<u>SR Level</u>	<u>BU Code</u>	<u>T/P</u>	<u>MOF</u>	<u>FTE</u>	<u>Annual Salary</u>	<u>Filled (Y/N)</u>	<u>Occupied by 89 Day Hire (Y/N)</u>
EDN150	3/23/2012	302A-1116, HRS	802544	Behavioral Hlth Spclt IV	N	SR22	13	T	N	1.00	\$40,025	Y	N
EDN150	5/14/2012	302A-1116, HRS	802596	Behavioral Hlth Spclt IV	N	SR22	13	T	A	1.00	\$44,412	Y	N
EDN150	5/14/2012	302A-1116, HRS	802597	Behavioral Hlth Spclt IV	N	SR22	13	T	A	1.00	\$44,412	Y	N
EDN150	4/20/2012	302A-1116, HRS	802598	Educ Asst III	Y	SR12	03	T	A	1.00	\$30,036	Y	N
EDN150	4/20/2012	302A-1116, HRS	802599	Educ Asst III	Y	SR12	03	T	A	1.00	\$30,036	Y	Y
EDN150	4/20/2012	302A-1116, HRS	802600	Educ Asst III	Y	SR12	03	T	A	1.00	\$30,036	Y	Y
EDN150	4/20/2012	302A-1116, HRS	802601	Educ Asst III	Y	SR12	03	T	A	1.00	\$30,036	N	N
EDN150	3/18/2013	302A-1116, HRS	802602	Educ Asst III	Y	SR12	03	T	A	1.00	\$30,036	N	N
EDN150	7/1/2012	302A-1116, HRS	802631	Educ Asst III	Y	SR12	03	T	N	1.00	\$28,534	N	N
EDN150	7/1/2012	302A-1116, HRS	802632	Educ Asst III	Y	SR12	03	T	N	1.00	\$24,824	Y	N
EDN150	7/1/2012	302A-1116, HRS	802666	Educ Asst III	Y	SR12	03	T	N	1.00	\$28,534	N	N
EDN150	1/4/2013	302A-1116, HRS	802924	Clinical Psychologist VI	N	SR26	13	T	A	1.00	\$52,725	Y	Y
EDN150	1/16/2013	302A-1116, HRS	802927	Clinical Psychologist VI	N	SR26	13	T	N	1.00	\$52,725	N	N
EDN150	1/16/2013	302A-1116, HRS	802928	Occupational Therapist IV	N	SR22	13	T	N	1.00	\$43,297	N	N
EDN150	2/25/2013	302A-1116, HRS	802944	Educ Asst III	Y	SR12	03	T	N	1.00	\$28,534	N	N
EDN150	2/25/2013	302A-1116, HRS	802946	Speech Pathologist IV	Y	SR22	13	T	N	1.00	\$43,297	N	N
EDN200	7/1/2012	302A-1116, HRS	29998	Bilingual/Bicultural S/H Asst	Y	SR11	03	T	A	0.50	\$14,418	N	N
EDN200	1/1/2013	302A-1116, HRS	64428	Elem Teacher	Certificated	T01	05	T	N	0.50	\$23,488	Y	N
EDN150	7/1/2010	302A-1116, HRS	74728	Educational Spec II	Y	E07	06	T	A	1.00	\$74,239	Y	N
EDN200	7/1/2010	302A-1116, HRS	76056	Educational Spec II	Y	E07	06	T	A	1.00	\$73,216	N	N
EDN200	7/27/2010	302A-1116, HRS	76171	State Office Teacher	Certificated	T05	05	T	U	1.00	\$57,693	Y	N
EDN200	7/15/2011	302A-1116, HRS	79150	Assistant Superintendent for Strategic Reform	Certificated	E00	06	T	N	1.00	\$109,250	Y	N
EDN200	6/26/2012	302A-1116, HRS	79194	Data Fellow	Certificated	E07	06	T	N	1.00	\$82,973	Y	N
EDN200	7/10/2009	302A-1116, HRS	79221	Special Projects Director	Certificated	E10	06	T	N	1.00	\$94,031	Y	N
EDN200	1/1/2013	302A-1116, HRS	79321	District Educ Spec II	Certificated	E07	06	T	A	1.00	\$86,951	Y	N
EDN100	7/1/2012	302A-1116, HRS	79789	Spec Prog Mgmt Spec II	Certificated	E07	06	T	N	1.00	\$73,216	Y	N
EDN200	7/1/2012	302A-1116, HRS	600470	Complex Sch Renew Spec II	Certificated	E07	06	T	A	1.00	\$91,981	N	N
EDN100	9/15/2010	302A-1116, HRS	600908	Vice Principal I	Certificated	E03	06	T	A	1.00	\$60,390	Y	N
EDN200	10/25/2010	302A-1116, HRS	600956	Dist Off Tchr	Certificated	T02	05	T	N	1.00	\$47,432	Y	N
EDN200	10/25/2010	302A-1116, HRS	600959	Dist Off Tchr	Certificated	T02	05	T	N	1.00	\$81,011	Y	N
EDN200	11/5/2010	302A-1116, HRS	600990	Instit Analyst III	Certificated	E08	06	T	N	1.00	\$76,333	Y	N
EDN200	1/27/2012	302A-1116, HRS	600991	Instit Analyst II	Certificated	T	06	T	N	1.00	\$85,313	Y	N
EDN200	11/5/2010	302A-1116, HRS	600992	Instit Analyst II	Certificated	T	06	T	N	1.00	\$73,216	Y	N
EDN200	11/5/2010	302A-1116, HRS	600993	Instit Analyst III	Certificated	E08	06	T	N	1.00	\$91,454	Y	N
EDN200	11/12/2010	302A-1116, HRS	600994	Instit Analyst III	Certificated	E08	06	T	N	1.00	\$78,485	Y	N
EDN200	11/5/2010	302A-1116, HRS	600995	Instit Analyst II	Certificated	T	06	T	N	1.00	\$73,216	Y	N
EDN200	11/5/2010	302A-1116, HRS	600996	Instit Analyst II	Certificated	T	06	T	N	1.00	\$73,216	Y	N
EDN200	11/5/2010	302A-1116, HRS	600997	Personnel Specialist II	Certificated	E07	06	T	N	1.00	\$73,216	Y	N
EDN200	11/5/2010	302A-1116, HRS	600998	Personnel Specialist II	Certificated	E07	06	T	N	1.00	\$73,216	Y	N
EDN200	11/5/2010	302A-1116, HRS	600999	Personnel Specialist II	Certificated	E07	06	T	N	1.00	\$73,216	Y	N
EDN200	11/5/2010	302A-1116, HRS	601000	Personnel Specialist II	Certificated	E07	06	T	N	1.00	\$79,583	Y	N
EDN200	7/26/2011	302A-1116, HRS	601057	Secondary Teacher	Certificated	T01	05	T	N	1.00	\$53,635	Y	N
EDN200	7/26/2011	302A-1116, HRS	601058	Elem Teacher	Certificated	T01	05	T	N	1.00	\$81,011	Y	N
EDN200	7/26/2011	302A-1116, HRS	601059	Secondary Teacher	Certificated	T01	05	T	N	1.00	\$62,140	Y	N
EDN200	7/26/2011	302A-1116, HRS	601060	Elem Teacher	Certificated	T01	05	T	N	1.00	\$53,635	Y	N

<u>Prog ID</u>	<u>Date Established</u>	<u>Legal Authority</u>	<u>Position Number</u>	<u>Position Title</u>	<u>Exempt (Y/N)</u>	<u>SR Level</u>	<u>BU Code</u>	<u>T/P</u>	<u>MOF</u>	<u>FTE</u>	<u>Annual Salary</u>	<u>Filled (Y/N)</u>	<u>Occupied by 89 Day Hire (Y/N)</u>
EDN200	7/26/2011	302A-1116, HRS	601061	Elem Teacher	Certificated	T01	05	T	N	1.00	\$57,453	Y	N
EDN200	7/26/2011	302A-1116, HRS	601062	Secondary Teacher	Certificated	T01	05	T	N	1.00	\$81,011	Y	N
EDN200	7/26/2011	302A-1116, HRS	601063	Elem Teacher	Certificated	T01	05	T	N	1.00	\$59,752	Y	N
EDN200	7/26/2011	302A-1116, HRS	601064	Elem Teacher	Certificated	T01	05	T	N	1.00	\$66,605	Y	N
EDN200	1/1/2011	302A-1116, HRS	601079	Complex Area Personnel Specialist II	Certificated	E07	06	T	A	1.00	\$86,847	Y	N
EDN200	1/1/2011	302A-1116, HRS	601086	Complex Area Personnel Specialist II	Certificated	E07	06	T	A	1.00	\$86,847	N	N
EDN200	7/26/2011	302A-1116, HRS	601091	Secondary Teacher	Certificated	T01	05	T	N	1.00	\$81,011	Y	N
EDN200	7/26/2011	302A-1116, HRS	601092	Elem Teacher	Certificated	T01	05	T	N	1.00	\$62,276	Y	N
EDN200	7/26/2011	302A-1116, HRS	601093	Elem Teacher	Certificated	T01	05	T	N	1.00	\$53,079	Y	N
EDN200	7/26/2011	302A-1116, HRS	601094	Secondary Teacher	Certificated	T01	05	T	N	1.00	\$81,011	Y	N
EDN200	7/26/2011	302A-1116, HRS	601095	Secondary Teacher	Certificated	T01	05	T	N	1.00	\$65,869	Y	N
EDN200	7/26/2011	302A-1116, HRS	601096	Elem Teacher	Certificated	T01	05	T	N	1.00	\$69,880	Y	N
EDN200	7/26/2011	302A-1116, HRS	601097	Elem Teacher	Certificated	T01	05	T	N	1.00	\$78,651	Y	N
EDN200	7/26/2011	302A-1116, HRS	601098	Elem Teacher	Certificated	T01	05	T	N	1.00	\$78,719	N	N
EDN200	1/3/2011	302A-1116, HRS	601149	12-Mo State Off Tchr	Certificated	T02	05	T	N	1.00	\$53,134	Y	N
EDN200	1/3/2011	302A-1116, HRS	601150	12-Mo State Off Tchr	Certificated	T02	05	T	N	1.00	\$74,053	Y	N
EDN200	7/1/2011	302A-1116, HRS	601698	12-Mo State Off Tchr	Certificated	T02	05	T	N	1.00	\$75,649	Y	N
EDN200	7/1/2011	302A-1116, HRS	601699	12-Mo State Off Tchr	Certificated	T02	05	T	N	1.00	\$69,231	Y	N
EDN200	7/1/2011	302A-1116, HRS	601700	12-Mo State Off Tchr	Certificated	T02	05	T	N	1.00	\$73,446	Y	N
EDN200	7/1/2011	302A-1116, HRS	601701	12-Mo State Off Tchr	Certificated	T02	05	T	N	1.00	\$67,213	Y	N
EDN200	7/1/2011	302A-1116, HRS	601702	12-Mo State Off Tchr	Certificated	T02	05	T	N	1.00	\$80,256	Y	N
EDN200	7/1/2011	302A-1116, HRS	601703	12-Mo State Off Tchr	Certificated	T02	05	T	N	1.00	\$56,918	Y	N
EDN200	7/1/2011	302A-1116, HRS	601704	12-Mo State Off Tchr	Certificated	T02	05	T	N	1.00	\$69,231	Y	N
EDN200	7/1/2011	302A-1116, HRS	601705	12-Mo State Off Tchr	Certificated	T02	05	T	N	1.00	\$69,287	Y	N
EDN200	7/1/2011	302A-1116, HRS	601706	12-Mo State Off Tchr	Certificated	T02	05	T	N	1.00	\$72,801	Y	N
EDN200	7/1/2011	302A-1116, HRS	601707	12-Mo State Off Tchr	Certificated	T02	05	T	N	1.00	\$65,311	Y	N
EDN200	7/1/2011	302A-1116, HRS	601708	12-Mo State Off Tchr	Certificated	T02	05	T	N	1.00	\$80,256	Y	N
EDN200	7/1/2011	302A-1116, HRS	601709	12-Mo State Off Tchr	Certificated	T02	05	T	N	1.00	\$73,509	Y	N
EDN200	7/1/2011	302A-1116, HRS	601710	12-Mo State Off Tchr	Certificated	T02	05	T	N	1.00	\$76,735	Y	N
EDN200	7/1/2011	302A-1116, HRS	601711	12-Mo State Off Tchr	Certificated	T02	05	T	N	1.00	\$69,231	Y	N
EDN200	7/1/2011	302A-1116, HRS	601712	12-Mo State Off Tchr	Certificated	T02	05	T	N	1.00	\$72,035	Y	N
EDN200	7/1/2011	302A-1116, HRS	601713	12-Mo State Off Tchr	Certificated	T02	05	T	N	1.00	\$49,199	N	N
EDN200	2/9/2011	302A-1116, HRS	601798	Instit Analyst II	Certificated	T	06	T	N	1.00	\$81,826	N	N
EDN200	7/26/2011	302A-1116, HRS	602056	Special Sch Teacher	Certificated	T02	05	T	N	1.00	\$36,547	Y	N
EDN200	7/26/2011	302A-1116, HRS	602059	Secondary Teacher	Certificated	T01	05	T	N	1.00	\$69,880	Y	N
EDN200	7/26/2011	302A-1116, HRS	602064	Elem Teacher	Certificated	T01	05	T	N	1.00	\$78,651	Y	N
EDN200	7/26/2011	302A-1116, HRS	602065	Elem Teacher	Certificated	T01	05	T	N	1.00	\$71,979	Y	N
EDN200	7/1/2011	302A-1116, HRS	602123	Complx Sch Renew Spec II	Certificated	E07	06	T	A	1.00	\$91,981	N	N
EDN200	7/1/2011	302A-1116, HRS	602127	District Educ Spec II	Certificated	E07	06	T	A	1.00	\$86,951	Y	N
EDN200	7/1/2011	302A-1116, HRS	602261	DOE Comm Spec II	Certificated	E07	06	T	N	1.00	\$73,216	N	N
EDN200	7/1/2011	302A-1116, HRS	602298	District Educ Spec II	Certificated	E07	06	T	A	1.00	\$103,644	Y	N
EDN200	7/26/2011	302A-1116, HRS	602360	Elem Teacher	Certificated	T01	05	T	N	1.00	\$67,846	Y	N
EDN200	7/26/2011	302A-1116, HRS	602361	Secondary Teacher	Certificated	T01	05	T	N	1.00	\$53,635	Y	N
EDN200	7/26/2011	302A-1116, HRS	602362	Secondary Teacher	Certificated	T01	05	T	N	1.00	\$78,959	Y	N
EDN200	7/26/2011	302A-1116, HRS	602363	Secondary Teacher	Certificated	T01	05	T	N	1.00	\$53,635	Y	N

Department of Education
Unappropriated Positions as of June 28, 2013

Table 17

<u>Prog ID</u>	<u>Date Established</u>	<u>Legal Authority</u>	<u>Position Number</u>	<u>Position Title</u>	<u>Exempt (Y/N)</u>	<u>SR Level</u>	<u>BU Code</u>	<u>T/P</u>	<u>MOF</u>	<u>FTE</u>	<u>Annual Salary</u>	<u>Filled (Y/N)</u>	<u>Occupied by 89 Day Hire (Y/N)</u>
EDN200	7/26/2011	302A-1116, HRS	602364	Elem Teacher	Certificated	T01	05	T	N	1.00	\$65,963	Y	N
EDN200	7/26/2011	302A-1116, HRS	602365	Elem Teacher	Certificated	T01	05	T	N	1.00	\$57,453	Y	N
EDN200	7/26/2011	302A-1116, HRS	602366	Secondary Teacher	Certificated	T01	05	T	N	1.00	\$56,493	Y	N
EDN200	7/26/2011	302A-1116, HRS	602367	Elem Teacher	Certificated	T01	05	T	N	1.00	\$65,926	Y	N
EDN200	7/26/2011	302A-1116, HRS	602368	Secondary Teacher	Certificated	T01	05	T	N	1.00	\$67,846	Y	N
EDN200	7/26/2011	302A-1116, HRS	602369	Elem Teacher	Certificated	T01	05	T	N	1.00	\$76,362	Y	N
EDN200	7/26/2011	302A-1116, HRS	602370	Elem Teacher	Certificated	T01	05	T	N	1.00	\$55,780	Y	N
EDN200	7/26/2011	302A-1116, HRS	602371	Elem Teacher	Certificated	T01	05	T	N	1.00	\$67,846	Y	N
EDN200	7/26/2011	302A-1116, HRS	602372	Secondary Teacher	Certificated	T01	05	T	N	1.00	\$71,979	Y	N
EDN200	7/26/2011	302A-1116, HRS	602373	Secondary Teacher	Certificated	T01	05	T	N	1.00	\$55,243	Y	N
EDN200	7/26/2011	302A-1116, HRS	602374	Elem Teacher	Certificated	T01	05	T	N	1.00	\$76,362	Y	N
EDN200	7/26/2011	302A-1116, HRS	602375	Elem Teacher	Certificated	T01	05	T	N	1.00	\$59,752	Y	N
EDN200	7/26/2011	302A-1116, HRS	602376	Elem Teacher	Certificated	T01	05	T	N	1.00	\$67,846	Y	N
EDN200	7/26/2011	302A-1116, HRS	602377	Elem Teacher	Certificated	T01	05	T	N	1.00	\$74,137	Y	N
EDN200	11/21/2011	302A-1116, HRS	602488	District Educ Spec II	Certificated	E07	06	T	A	1.00	\$82,973	Y	N
EDN200	2/1/2012	302A-1116, HRS	602536	Instit Analyst II	Certificated	T	06	T	N	1.00	\$73,216	Y	N
EDN200	7/1/2012	302A-1116, HRS	603193	12-Mo State Off Tchr	Certificated	T02	05	T	N	1.00	\$71,306	N	N
EDN200	4/9/2012	302A-1116, HRS	603316	Pers Regional Officer II	Certificated	E07	06	T	N	1.00	\$80,700	Y	N
EDN200	5/1/2012	302A-1116, HRS	603324	District Educ Spec II	Certificated	E07	06	T	A	1.00	\$73,216	Y	N
EDN200	7/1/2012	302A-1116, HRS	603406	12-Mo State Off Tchr	Certificated	T02	05	T	A	1.00	\$75,649	Y	N
EDN200	7/24/2012	302A-1116, HRS	603407	State Office Teacher	Certificated	T05	05	T	A	1.00	\$52,840	Y	N
EDN200	7/24/2012	302A-1116, HRS	603408	State Office Teacher	Certificated	T05	05	T	A	1.00	\$66,880	Y	N
EDN200	7/11/2012	302A-1116, HRS	603545	Pers Regional Officer II	Certificated	E07	06	T	N	1.00	\$103,101	Y	N
EDN200	8/1/2012	302A-1116, HRS	603554	12-Mo State Off Tchr	Certificated	T02	05	T	N	1.00	\$77,919	Y	N
EDN200	8/1/2012	302A-1116, HRS	603555	12-Mo State Off Tchr	Certificated	T02	05	T	N	1.00	\$56,370	Y	N
EDN200	10/17/2012	302A-1116, HRS	603676	Personnel Specialist II	Certificated	E07	06	T	N	1.00	\$73,216	Y	N
EDN200	2/19/2013	302A-1116, HRS	604324	Secondary Teacher	Certificated	T01	05	T	A	1.00	\$40,999	N	N
EDN200	2/19/2013	302A-1116, HRS	604325	Secondary Teacher	Certificated	T01	05	T	A	1.00	\$56,010	Y	N
EDN200	3/21/2013	302A-1116, HRS	604364	Educational Spec II	Y	E07	06	T	A	1.00	\$77,069	Y	N
EDN200	8/14/2008	302A-1116, HRS	801171	Office Assistant IV	N	SR10	03	T	A	1.00	\$27,756	Y	N
EDN200	1/15/2009	302A-1116, HRS	801307	Community Relations Prgm Asst	N	SR15	03	T	N	1.00	\$32,068	Y	N
EDN200	11/5/2010	302A-1116, HRS	801818	Secretary IV	N	SR18	03	T	N	1.00	\$36,070	N	N
EDN200	11/5/2010	302A-1116, HRS	801819	Secretary IV	N	SR18	03	T	N	1.00	\$36,070	Y	N
EDN200	11/5/2010	302A-1116, HRS	801820	Office Assistant III	N	SR08	03	T	N	1.00	\$24,385	Y	N
EDN200	11/5/2010	302A-1116, HRS	801821	Personnel Mgmt Specialist IV	N	SR22	13	T	N	1.00	\$43,297	Y	N
EDN200	11/5/2010	302A-1116, HRS	801822	Personnel Mgmt Specialist IV	N	SR22	13	T	N	1.00	\$42,191	N	N
EDN200	11/5/2010	302A-1116, HRS	801824	Secretary II	N	SR14	03	T	N	1.00	\$30,803	Y	N
EDN200	11/5/2010	302A-1116, HRS	801825	Personnel Clerk V	N	SR13	03	T	N	1.00	\$29,651	Y	Y
EDN200	12/29/2010	302A-1116, HRS	801957	Office Assistant III	N	SR08	03	T	A	0.50	\$12,834	Y	Y
EDN200	7/1/2011	302A-1116, HRS	802011	Account Clerk II	N	SR08	03	T	A	1.00	\$24,385	Y	N
EDN200	10/10/2011	302A-1116, HRS	802393	School Custodian II	N	BC02	01	T	A	0.50	\$16,614	Y	N
EDN200	11/16/2011	302A-1116, HRS	802428	Office Assistant III	N	SR08	03	T	A	1.00	\$24,385	Y	Y
EDN200	11/18/2011	302A-1116, HRS	802431	Office Assistant III	N	SR08	03	T	N	1.00	\$24,385	N	N
EDN200	11/18/2011	302A-1116, HRS	802432	Office Assistant III	N	SR08	03	T	N	1.00	\$24,385	N	N
EDN200	10/1/2012	302A-1116, HRS	802680	Account Clerk III	N	SR11	03	T	N	1.00	\$27,394	Y	N

Department of Education
Unappropriated Positions as of June 28, 2013

Table 17

<u>Prog ID</u>	<u>Date Established</u>	<u>Legal Authority</u>	<u>Position Number</u>	<u>Position Title</u>	<u>Exempt (Y/N)</u>	<u>SR Level</u>	<u>BU Code</u>	<u>T/P</u>	<u>MOF</u>	<u>FTE</u>	<u>Annual Salary</u>	<u>Filled (Y/N)</u>	<u>Occupied by 89 Day Hire (Y/N)</u>
EDN200	8/6/2012	302A-1116, HRS	802716	Secretary II	N	SR14	03	T	A	1.00	\$30,803	N	N
EDN200	8/6/2012	302A-1116, HRS	802717	Secretary II	N	SR14	03	T	A	1.00	\$30,803	N	N
EDN200	8/6/2012	302A-1116, HRS	802718	Secretary II	N	SR14	03	T	A	1.00	\$30,803	N	N
EDN200	9/24/2012	302A-1116, HRS	802795	Account Clerk III	N	SR11	03	T	A	1.00	\$27,394	Y	N
EDN200	1/15/2013	302A-1116, HRS	802926	Business Mgmt Officer I	N	EM05	13	T	N	1.00	\$68,172	N	N
EDN300	7/1/2009	302A-1116, HRS	75141	12-Mo State Off Tchr	Certificated	T02	05	T	A	1.00	\$69,231	Y	N
EDN300	7/1/2009	302A-1116, HRS	75147	12-Mo State Off Tchr	Certificated	T02	05	T	A	1.00	\$77,919	Y	N
EDN300	7/1/2009	302A-1116, HRS	75148	12-Mo State Off Tchr	Certificated	T02	05	T	A	1.00	\$69,231	Y	N
EDN300	7/1/2009	302A-1116, HRS	75151	12-Mo State Off Tchr	Certificated	T02	05	T	A	1.00	\$71,306	Y	N
EDN300	6/25/2012	302A-1116, HRS	75886	Civ Rights Compl Spec II	Certificated	E07	06	T	A	1.00	\$73,216	N	N
EDN300	7/17/2009	302A-1116, HRS	79143	DOE Decision Supp Spec I	Certificated	E06	06	T	N	1.00	\$70,225	Y	N
EDN300	7/17/2009	302A-1116, HRS	79144	DOE Decision Supp Spec I	Certificated	E06	06	T	N	1.00	\$70,225	N	N
EDN300	1/3/2012	302A-1116, HRS	600921	Evaluation Spec II	Certificated	E07	06	T	A	1.00	\$73,216	Y	N
EDN300	11/29/2010	302A-1116, HRS	601056	DOE Comm Spec II	Certificated	E07	06	T	A	1.00	\$73,216	Y	N
EDN300	7/5/2012	302A-1116, HRS	603169	DOE Comm Spec II	Certificated	E07	06	T	A	1.00	\$73,216	N	N
EDN300	7/5/2012	302A-1116, HRS	603243	DOE Comm Spec II	Certificated	E07	06	T	A	1.00	\$73,216	Y	N
EDN300	6/20/2012	302A-1116, HRS	603467	DOE Comm Director	Certificated	E10	06	T	A	1.00	\$95,349	Y	N
EDN300	6/21/2012	302A-1116, HRS	603473	DOE Comm Spec II	Certificated	E07	06	T	A	1.00	\$73,216	Y	N
EDN300	7/1/2012	302A-1116, HRS	603501	Pers Regional Officer II	Certificated	E07	06	T	A	1.00	\$108,996	Y	N
EDN300	10/5/2012	302A-1116, HRS	603661	Personnel Specialist II	Certificated	E07	06	T	A	1.00	\$73,216	N	N
EDN300	10/5/2012	302A-1116, HRS	603662	Personnel Specialist II	Certificated	E07	06	T	A	1.00	\$73,216	N	N
EDN300	12/20/2012	302A-1116, HRS	603712	Instit Analyst III	Certificated	E08	06	T	A	1.00	\$76,333	Y	N
EDN300	11/24/2004	302A-1116, HRS	800126	Educ Asst III	Y	SR12	03	T	A	1.00	\$30,036	Y	Y
EDN300	11/24/2004	302A-1116, HRS	800127	Educ Asst III	Y	SR12	03	T	A	1.00	\$30,036	N	N
EDN300	11/24/2004	302A-1116, HRS	800128	Educ Asst III	Y	SR12	03	T	A	1.00	\$30,036	N	N
EDN300	11/24/2004	302A-1116, HRS	800129	Educ Asst III	Y	SR12	03	T	A	1.00	\$30,036	N	N
EDN300	11/24/2004	302A-1116, HRS	800130	Educ Asst III	Y	SR12	03	T	A	1.00	\$30,036	N	N
EDN300	11/24/2004	302A-1116, HRS	800131	Educ Asst III	Y	SR12	03	T	A	1.00	\$30,036	Y	Y
EDN300	11/24/2004	302A-1116, HRS	800132	Educ Asst III	Y	SR12	03	T	A	1.00	\$30,036	N	N
EDN300	11/24/2004	302A-1116, HRS	800133	Educ Asst III	Y	SR12	03	T	A	1.00	\$30,036	N	N
EDN300	11/24/2004	302A-1116, HRS	800134	Educ Asst III	Y	SR12	03	T	A	1.00	\$30,036	N	N
EDN300	11/24/2004	302A-1116, HRS	800135	Educ Asst III	Y	SR12	03	T	A	1.00	\$30,036	N	N
EDN300	4/30/2008	302A-1116, HRS	801044	Data Procsg Sys Anal IV	N	SR22	13	T	A	1.00	\$37,039	Y	N
EDN300	5/9/2008	302A-1116, HRS	801054	Data Procsg Sys Anal IV	N	SR22	13	T	A	1.00	\$42,191	N	N
EDN300	10/3/2008	302A-1116, HRS	801209	Accountant IV	N	SR22	13	T	A	1.00	\$42,191	Y	Y
EDN300	10/3/2008	302A-1116, HRS	801210	Claims Pre Audit Supervisor	N	SR22	13	T	A	1.00	\$42,191	N	N
EDN300	6/30/2009	302A-1116, HRS	801399	Data Procsg Sys Anal IV	N	SR22	13	T	N	1.00	\$43,297	Y	N
EDN300	6/30/2009	302A-1116, HRS	801400	Data Procsg Sys Anal IV	N	SR22	13	T	N	1.00	\$42,191	N	N
EDN300	7/26/2012	302A-1116, HRS	802705	Secretary IV	N	SR18	03	T	A	1.00	\$36,070	N	N
EDN300	8/20/2012	302A-1116, HRS	802738	Office Assistant IV	N	SR10	03	T	A	1.00	\$26,368	Y	N
EDN400	1/20/2000	302A-1116, HRS	19126	Prgm Splct V	N	SR24	13	T	N	1.00	\$54,823	Y	N
EDN400	12/14/1999	302A-1116, HRS	55503	Cafeteria Helper	N	BC02	01	T	N	0.50	\$16,614	Y	N
EDN400	12/29/1999	302A-1116, HRS	55510	Cafeteria Helper	N	BC02	01	T	N	0.50	\$16,614	Y	N
EDN400	12/29/1999	302A-1116, HRS	55512	Cafeteria Helper	N	BC02	01	T	A	0.50	\$16,614	Y	N
EDN400	12/29/1999	302A-1116, HRS	55527	Cafeteria Helper	N	BC02	01	T	N	0.50	\$16,614	Y	N

<u>Prog ID</u>	<u>Date Established</u>	<u>Legal Authority</u>	<u>Position Number</u>	<u>Position Title</u>	<u>Exempt (Y/N)</u>	<u>SR Level</u>	<u>BU Code</u>	<u>T/P</u>	<u>MOF</u>	<u>FTE</u>	<u>Annual Salary</u>	<u>Filled (Y/N)</u>	<u>Occupied by 89 Day Hire (Y/N)</u>
EDN400	12/29/1999	302A-1116, HRS	55528	Cafeteria Helper	N	BC02	01	T	N	0.50	\$16,614	Y	N
EDN400	1/3/2000	302A-1116, HRS	55529	Food Services Driver	N	BC03	01	T	N	0.50	\$17,082	Y	N
EDN400	1/7/2000	302A-1116, HRS	55530	Cafeteria Helper	N	BC02	01	T	N	0.50	\$16,614	Y	N
EDN400	2/28/2000	302A-1116, HRS	55552	Cafeteria Helper	N	BC02	01	T	N	0.50	\$16,614	N	N
EDN400	8/11/2000	302A-1116, HRS	55712	Cafeteria Helper	N	BC02	01	T	N	0.50	\$16,614	N	N
EDN400	9/6/2000	302A-1116, HRS	55921	Food Services Driver	N	BC03	01	T	N	1.00	\$34,164	Y	N
EDN400	11/3/2000	302A-1116, HRS	56155	Office Assistant III	N	SR08	03	T	B	0.50	\$24,385	N	N
EDN400	12/5/2000	302A-1116, HRS	56201	Cafeteria Helper	N	BC02	01	T	N	0.50	\$16,614	Y	N
EDN400	12/7/2000	302A-1116, HRS	56205	Cafeteria Helper	N	BC02	01	T	N	0.50	\$16,614	Y	N
EDN400	12/27/2000	302A-1116, HRS	56263	Cafeteria Helper	N	BC02	01	T	N	0.50	\$16,614	Y	N
EDN400	1/9/2001	302A-1116, HRS	56298	Cafeteria Helper	N	BC02	01	T	N	0.50	\$16,614	N	N
EDN400	1/9/2001	302A-1116, HRS	56299	Cafeteria Helper	N	BC02	01	T	N	0.50	\$16,614	Y	N
EDN400	1/9/2001	302A-1116, HRS	56301	Cafeteria Helper	N	BC02	01	T	N	0.50	\$16,614	N	N
EDN400	1/9/2001	302A-1116, HRS	56302	Cafeteria Helper	N	BC02	01	T	N	0.50	\$16,614	N	N
EDN400	7/5/2001	302A-1116, HRS	56470	Cafeteria Helper	N	BC02	01	T	N	0.50	\$16,614	Y	N
EDN400	7/5/2001	302A-1116, HRS	56472	Cafeteria Helper	N	BC02	01	T	N	0.50	\$16,614	Y	Y
EDN400	7/24/2001	302A-1116, HRS	56639	Cafeteria Helper	N	BC02	01	T	N	0.50	\$16,614	Y	N
EDN400	9/24/2001	302A-1116, HRS	57694	Cafeteria Helper	N	BC02	01	T	A	0.50	\$16,614	Y	N
EDN400	9/24/2001	302A-1116, HRS	57695	Food Services Driver	N	BC03	01	T	A	1.00	\$34,164	Y	N
EDN400	9/24/2001	302A-1116, HRS	57696	Food Services Driver	N	BC03	01	T	A	1.00	\$34,164	N	N
EDN400	9/24/2001	302A-1116, HRS	57697	Cafeteria Helper	N	BC02	01	T	A	0.50	\$16,614	N	N
EDN400	9/24/2001	302A-1116, HRS	57700	Cafeteria Helper	N	BC02	01	T	N	0.50	\$16,614	Y	N
EDN400	9/26/2001	302A-1116, HRS	57711	Cafeteria Helper	N	BC02	01	T	N	0.50	\$16,614	Y	N
EDN400	11/19/2001	302A-1116, HRS	57776	Cafeteria Helper	N	BC02	01	T	N	0.50	\$16,614	Y	N
EDN400	11/7/2001	302A-1116, HRS	57780	Cafeteria Helper	N	BC02	01	T	N	0.50	\$16,614	Y	N
EDN400	12/3/2001	302A-1116, HRS	57817	Cafeteria Helper	N	BC02	01	T	N	0.50	\$16,614	Y	N
EDN400	12/24/2001	302A-1116, HRS	57841	Cafeteria Helper	N	BC02	01	T	N	0.50	\$16,614	Y	N
EDN400	1/4/2002	302A-1116, HRS	57873	Cafeteria Helper	N	BC02	01	T	N	0.50	\$16,614	N	N
EDN400	2/27/2002	302A-1116, HRS	57901	Cafeteria Helper	N	BC02	01	T	N	0.50	\$16,614	Y	N
EDN400	3/22/2002	302A-1116, HRS	57907	Cafeteria Helper	N	BC02	01	T	N	0.50	\$16,614	Y	N
EDN400	5/10/2002	302A-1116, HRS	57928	Cafeteria Helper	N	BC02	01	T	N	0.50	\$16,614	Y	N
EDN400	4/30/2002	302A-1116, HRS	57930	Cafeteria Helper	N	BC02	01	T	N	0.50	\$16,614	Y	N
EDN400	5/20/2002	302A-1116, HRS	57978	Cafeteria Helper	N	BC02	01	T	N	0.50	\$16,614	Y	N
EDN400	11/19/2002	302A-1116, HRS	58554	Cafeteria Helper	N	BC02	01	T	A	0.50	\$16,614	Y	N
EDN400	11/19/2002	302A-1116, HRS	58555	Cafeteria Helper	N	BC02	01	T	A	0.50	\$16,614	Y	N
EDN400	12/13/2002	302A-1116, HRS	58580	Cafeteria Helper	N	BC02	01	T	N	0.50	\$16,614	N	N
EDN400	12/13/2002	302A-1116, HRS	58581	Cafeteria Helper	N	BC02	01	T	N	0.50	\$16,614	N	N
EDN400	12/13/2002	302A-1116, HRS	58589	Cafeteria Helper	N	BC02	01	T	N	0.50	\$16,614	Y	N
EDN400	12/18/2002	302A-1116, HRS	58594	Cafeteria Helper	N	BC02	01	T	N	0.50	\$16,614	Y	N
EDN400	1/7/2003	302A-1116, HRS	58619	Cafeteria Helper	N	BC02	01	T	N	0.50	\$16,614	N	N
EDN400	1/7/2003	302A-1116, HRS	58620	Cafeteria Helper	N	BC02	01	T	N	0.50	\$16,614	Y	N
EDN400	4/17/2003	302A-1116, HRS	58692	Cafeteria Helper	N	BC02	01	T	N	0.50	\$16,614	N	N
EDN400	4/29/2003	302A-1116, HRS	58703	Cafeteria Helper	N	BC02	01	T	N	0.50	\$16,614	N	N
EDN400	5/7/2003	302A-1116, HRS	58714	Cafeteria Helper	N	BC02	01	T	B	0.50	\$16,614	Y	N
EDN400	9/3/2003	302A-1116, HRS	58837	Food Services Driver	N	BC03	01	T	N	1.00	\$34,164	Y	N

<u>Prog ID</u>	<u>Date Established</u>	<u>Legal Authority</u>	<u>Position Number</u>	<u>Position Title</u>	<u>Exempt (Y/N)</u>	<u>SR Level</u>	<u>BU Code</u>	<u>T/P</u>	<u>MOF</u>	<u>FTE</u>	<u>Annual Salary</u>	<u>Filled (Y/N)</u>	<u>Occupied by 89 Day Hire (Y/N)</u>
EDN400	10/10/2003	302A-1116, HRS	58854	Cafeteria Helper	N	BC02	01	T	N	0.50	\$16,614	Y	N
EDN400	11/24/2003	302A-1116, HRS	58896	Cafeteria Helper	N	BC02	01	T	N	0.50	\$16,614	Y	N
EDN400	11/24/2003	302A-1116, HRS	58897	Cafeteria Helper	N	BC02	01	T	N	0.50	\$16,614	Y	N
EDN400	11/26/2003	302A-1116, HRS	58898	Cafeteria Helper	N	BC02	01	T	N	0.50	\$16,614	Y	N
EDN400	11/26/2003	302A-1116, HRS	58899	Cafeteria Helper	N	BC02	01	T	N	0.50	\$16,614	N	N
EDN400	12/10/2003	302A-1116, HRS	58904	Cafeteria Helper	N	BC02	01	T	N	0.50	\$16,614	Y	N
EDN400	11/16/2004	302A-1116, HRS	59061	Cafeteria Helper	N	BC02	01	T	N	0.50	\$16,614	Y	N
EDN400	11/16/2004	302A-1116, HRS	59062	Cafeteria Helper	N	BC02	01	T	N	0.50	\$16,614	N	N
EDN400	11/16/2004	302A-1116, HRS	59063	Cafeteria Helper	N	BC02	01	T	N	0.50	\$16,614	N	N
EDN400	11/16/2004	302A-1116, HRS	59064	Cafeteria Helper	N	BC02	01	T	N	0.50	\$16,614	N	N
EDN400	11/16/2004	302A-1116, HRS	59065	Cafeteria Helper	N	BC02	01	T	N	0.50	\$16,614	N	N
EDN400	3/14/2005	302A-1116, HRS	59113	Cafeteria Helper	N	BC02	01	T	N	0.50	\$16,614	Y	N
EDN400	12/12/2003	302A-1116, HRS	59511	Cafeteria Helper	N	BC02	01	T	N	0.50	\$16,614	Y	N
EDN400	12/18/2003	302A-1116, HRS	59513	Cafeteria Helper	N	BC02	01	T	N	0.50	\$16,614	Y	N
EDN400	8/1/2005	302A-1116, HRS	59622	Cafeteria Helper	N	BC02	01	T	A	0.50	\$16,614	N	N
EDN400	11/14/2005	302A-1116, HRS	59643	Cafeteria Helper	N	BC02	01	T	N	0.50	\$16,614	N	N
EDN400	11/15/2005	302A-1116, HRS	59644	Cafeteria Helper	N	BC02	01	T	N	0.50	\$16,614	Y	N
EDN400	11/15/2005	302A-1116, HRS	59647	Cafeteria Helper	N	BC02	01	T	N	0.50	\$16,614	N	N
EDN400	11/15/2005	302A-1116, HRS	59648	Cafeteria Helper	N	BC02	01	T	N	0.50	\$16,614	Y	N
EDN400	11/21/2005	302A-1116, HRS	59667	Cafeteria Helper	N	BC02	01	T	N	0.50	\$16,614	N	N
EDN400	11/21/2005	302A-1116, HRS	59668	Cafeteria Helper	N	BC02	01	T	N	0.50	\$16,614	Y	N
EDN400	11/29/2005	302A-1116, HRS	59669	Cafeteria Helper	N	BC02	01	T	N	0.50	\$16,614	N	N
EDN400	1/17/2006	302A-1116, HRS	59680	Cafeteria Helper	N	BC02	01	T	N	0.50	\$16,614	N	N
EDN400	3/8/2006	302A-1116, HRS	59701	Cafeteria Helper	N	BC02	01	T	N	0.50	\$16,614	N	N
EDN400	9/20/2006	302A-1116, HRS	59861	Cafeteria Helper	N	BC02	01	T	N	0.50	\$16,614	N	N
EDN400	11/3/2006	302A-1116, HRS	59892	Cafeteria Helper	N	BC02	01	T	N	0.50	\$16,614	Y	N
EDN400	11/3/2006	302A-1116, HRS	59895	Cafeteria Helper	N	BC02	01	T	N	0.50	\$16,614	N	N
EDN400	11/27/2006	302A-1116, HRS	59906	Cafeteria Helper	N	BC02	01	T	N	0.50	\$16,614	Y	N
EDN400	11/27/2006	302A-1116, HRS	59907	Cafeteria Helper	N	BC02	01	T	N	0.50	\$16,614	N	N
EDN400	11/27/2006	302A-1116, HRS	59908	Cafeteria Helper	N	BC02	01	T	N	0.50	\$16,614	Y	N
EDN400	11/27/2006	302A-1116, HRS	59909	Cafeteria Helper	N	BC02	01	T	N	0.50	\$16,614	Y	N
EDN400	11/27/2006	302A-1116, HRS	59912	Cafeteria Helper	N	BC02	01	T	N	0.50	\$16,614	Y	N
EDN400	11/27/2006	302A-1116, HRS	59913	Cafeteria Helper	N	BC02	01	T	N	0.50	\$16,614	Y	N
EDN400	11/27/2006	302A-1116, HRS	59914	Cafeteria Helper	N	BC02	01	T	N	0.50	\$16,614	N	N
EDN400	11/27/2006	302A-1116, HRS	59915	Cafeteria Helper	N	BC02	01	T	N	0.50	\$16,614	Y	N
EDN400	12/5/2006	302A-1116, HRS	59917	Cafeteria Helper	N	BC02	01	T	N	0.50	\$16,614	N	N
EDN400	2/23/2007	302A-1116, HRS	59949	Cafeteria Helper	N	BC02	01	T	N	0.50	\$16,614	Y	N
EDN400	2/23/2007	302A-1116, HRS	59950	Cafeteria Helper	N	BC02	01	T	N	0.50	\$16,614	Y	N
EDN400	11/23/2007	302A-1116, HRS	800960	Cafeteria Helper	N	BC02	01	T	N	0.50	\$16,614	Y	N
EDN400	1/30/2008	302A-1116, HRS	800999	Cafeteria Helper	N	BC02	01	T	N	0.50	\$16,614	N	N
EDN400	4/8/2008	302A-1116, HRS	801031	Cafeteria Helper	N	BC02	01	T	A	0.50	\$16,614	N	N
EDN400	1/1/2012	302A-1116, HRS	801149	Office Assistant III	N	SR08	03	T	B	1.00	\$24,385	Y	N
EDN400	1/1/2012	302A-1116, HRS	801150	Office Assistant III	N	SR08	03	T	B	1.00	\$24,385	N	N
EDN400	1/1/2012	302A-1116, HRS	801152	Office Assistant III	N	SR08	03	T	B	1.00	\$24,385	N	N
EDN400	1/1/2012	302A-1116, HRS	801153	Office Assistant III	N	SR08	03	T	B	1.00	\$24,385	N	N

<u>Prog ID</u>	<u>Date Established</u>	<u>Legal Authority</u>	<u>Position Number</u>	<u>Position Title</u>	<u>Exempt (Y/N)</u>	<u>SR Level</u>	<u>BU Code</u>	<u>T/P</u>	<u>MOF</u>	<u>FTE</u>	<u>Annual Salary</u>	<u>Filled (Y/N)</u>	<u>Occupied by 89 Day Hire (Y/N)</u>
EDN400	1/1/2012	302A-1116, HRS	801154	Office Assistant III	N	SR08	03	T	B	1.00	\$24,385	N	N
EDN400	1/1/2012	302A-1116, HRS	801163	Office Assistant III	N	SR08	03	T	B	0.50	\$24,385	N	N
EDN400	10/23/2008	302A-1116, HRS	801247	Cafeteria Helper	N	BC02	01	T	N	0.50	\$16,614	Y	N
EDN400	10/23/2008	302A-1116, HRS	801248	Cafeteria Helper	N	BC02	01	T	N	0.50	\$16,614	Y	N
EDN400	10/27/2008	302A-1116, HRS	801267	Cafeteria Helper	N	BC02	01	T	N	0.50	\$16,614	N	N
EDN400	10/27/2008	302A-1116, HRS	801268	Cafeteria Helper	N	BC02	01	T	N	0.50	\$16,614	Y	Y
EDN400	11/15/2008	302A-1116, HRS	801269	Cafeteria Helper	N	BC02	01	T	N	0.50	\$16,614	Y	N
EDN400	11/17/2008	302A-1116, HRS	801288	Cafeteria Helper	N	BC02	01	T	A	0.50	\$16,614	N	N
EDN400	2/19/2009	302A-1116, HRS	801313	Office Assistant III	N	SR08	03	T	N	1.00	\$24,385	Y	N
EDN400	7/1/2009	302A-1116, HRS	801351	Food Services Driver	N	BC03	01	T	N	1.00	\$34,164	N	N
EDN400	11/15/2009	302A-1116, HRS	801482	Cafeteria Helper	N	BC02	01	T	A	0.50	\$16,614	Y	Y
EDN400	11/30/2009	302A-1116, HRS	801487	Cafeteria Helper	N	BC02	01	T	A	0.50	\$16,614	Y	N
EDN400	12/2/2009	302A-1116, HRS	801488	Cafeteria Helper	N	BC02	01	T	A	0.50	\$16,614	Y	N
EDN400	6/7/2010	302A-1116, HRS	801555	Accountant III	N	SR20	13	T	N	1.00	\$37,039	Y	N
EDN400	7/28/2010	302A-1116, HRS	801558	Food Services Driver	N	BC03	01	T	N	1.00	\$34,164	Y	Y
EDN400	12/1/2010	302A-1116, HRS	801643	Cafeteria Helper	N	BC02	01	T	N	0.50	\$16,614	Y	N
EDN400	12/1/2010	302A-1116, HRS	801644	Cafeteria Helper	N	BC02	01	T	N	0.50	\$16,614	Y	N
EDN400	9/14/2010	302A-1116, HRS	801721	Prgm Spclt IV (Child Nutr Prgms)	N	SR22	13	T	N	1.00	\$46,865	Y	N
EDN400	9/15/2010	302A-1116, HRS	801725	Cafeteria Helper	N	BC02	01	T	N	0.50	\$16,614	Y	N
EDN400	11/15/2010	302A-1116, HRS	801812	Cafeteria Helper	N	BC02	01	T	N	0.50	\$16,614	Y	N
EDN400	11/15/2010	302A-1116, HRS	801813	Cafeteria Helper	N	BC02	01	T	N	0.50	\$16,614	Y	N
EDN400	11/16/2010	302A-1116, HRS	801907	Cafeteria Helper	N	BC02	01	T	A	0.50	\$16,614	Y	N
EDN400	12/1/2010	302A-1116, HRS	801908	Cafeteria Helper	N	BC02	01	T	A	0.50	\$16,614	Y	N
EDN400	11/15/2010	302A-1116, HRS	801909	Cafeteria Helper	N	BC02	01	T	A	0.50	\$16,614	Y	N
EDN400	11/15/2010	302A-1116, HRS	801910	Cafeteria Helper	N	BC02	01	T	A	0.50	\$16,614	Y	N
EDN400	11/15/2010	302A-1116, HRS	801911	Cafeteria Helper	N	BC02	01	T	A	0.50	\$16,614	Y	N
EDN400	11/15/2010	302A-1116, HRS	801912	Cafeteria Helper	N	BC02	01	T	A	0.50	\$16,614	N	N
EDN400	11/15/2010	302A-1116, HRS	801914	Cafeteria Helper	N	BC02	01	T	A	0.50	\$16,614	Y	N
EDN400	11/15/2010	302A-1116, HRS	801915	Cafeteria Helper	N	BC02	01	T	A	0.50	\$16,614	Y	N
EDN400	11/15/2010	302A-1116, HRS	801916	Cafeteria Helper	N	BC02	01	T	A	0.50	\$16,614	Y	N
EDN400	11/15/2010	302A-1116, HRS	801917	Cafeteria Helper	N	BC02	01	T	A	0.50	\$16,614	Y	N
EDN400	11/15/2010	302A-1116, HRS	801918	Cafeteria Helper	N	BC02	01	T	A	0.50	\$16,614	N	N
EDN400	12/22/2010	302A-1116, HRS	801942	Cafeteria Helper	N	BC02	01	T	A	0.50	\$16,614	N	N
EDN400	11/16/2010	302A-1116, HRS	801945	Cafeteria Helper	N	BC02	01	T	A	0.50	\$16,614	Y	N
EDN400	11/15/2010	302A-1116, HRS	801946	Cafeteria Helper	N	BC02	01	T	A	0.50	\$16,614	Y	N
EDN400	12/22/2010	302A-1116, HRS	801948	Cafeteria Helper	N	BC02	01	T	A	0.50	\$16,614	Y	N
EDN400	12/27/2010	302A-1116, HRS	801958	Cafeteria Helper	N	BC02	01	T	A	0.50	\$16,614	N	N
EDN400	2/24/2011	302A-1116, HRS	802013	Cafeteria Helper	N	BC02	01	T	A	0.50	\$16,614	N	N
EDN400	8/5/2011	302A-1116, HRS	802299	Cafeteria Helper	N	BC02	01	T	N	0.50	\$16,614	Y	N
EDN400	9/30/2011	302A-1116, HRS	802359	School Lunch Services Supvr	N	SR24	13	T	B	1.00	\$48,746	Y	N
EDN400	9/30/2011	302A-1116, HRS	802360	School Lunch Services Supvr	N	SR24	13	T	B	1.00	\$48,746	Y	N
EDN400	9/30/2011	302A-1116, HRS	802361	School Lunch Services Supvr	N	SR24	13	T	B	1.00	\$45,646	N	N
EDN400	9/30/2011	302A-1116, HRS	802362	School Lunch Services Supvr	N	SR24	13	T	B	1.00	\$45,646	N	N
EDN400	11/15/2011	302A-1116, HRS	802402	Cafeteria Helper	N	BC02	01	T	N	0.50	\$16,614	Y	N
EDN400	11/15/2011	302A-1116, HRS	802403	Cafeteria Helper	N	BC02	01	T	N	0.50	\$16,614	Y	N

Department of Education
Unappropriated Positions as of June 28, 2013

Table 17

<u>Prog ID</u>	<u>Date Established</u>	<u>Legal Authority</u>	<u>Position Number</u>	<u>Position Title</u>	<u>Exempt (Y/N)</u>	<u>SR Level</u>	<u>BU Code</u>	<u>T/P</u>	<u>MOF</u>	<u>FTE</u>	<u>Annual Salary</u>	<u>Filled (Y/N)</u>	<u>Occupied by 89 Day Hire (Y/N)</u>
EDN400	11/15/2011	302A-1116, HRS	802404	Cafeteria Helper	N	BC02	01	T	N	0.50	\$16,614	N	N
EDN400	11/15/2011	302A-1116, HRS	802405	Cafeteria Helper	N	BC02	01	T	N	0.50	\$16,614	Y	N
EDN400	11/15/2011	302A-1116, HRS	802412	Cafeteria Helper	N	BC02	01	T	N	0.50	\$16,614	N	N
EDN400	11/15/2011	302A-1116, HRS	802413	Cafeteria Helper	N	BC02	01	T	N	0.50	\$16,614	Y	N
EDN400	11/15/2011	302A-1116, HRS	802414	Cafeteria Helper	N	BC02	01	T	N	0.50	\$16,614	Y	N
EDN400	11/15/2011	302A-1116, HRS	802415	Cafeteria Helper	N	BC02	01	T	N	0.50	\$16,614	Y	N
EDN400	11/15/2011	302A-1116, HRS	802416	Cafeteria Helper	N	BC02	01	T	N	0.50	\$16,614	N	N
EDN400	11/15/2011	302A-1116, HRS	802417	Cafeteria Helper	N	BC02	01	T	N	0.50	\$16,614	N	N
EDN400	11/15/2011	302A-1116, HRS	802429	School Cook I	N	BC04	01	T	A	1.00	\$35,544	Y	N
EDN400	12/30/2011	302A-1116, HRS	802468	Account Clerk IV	N	SR13	03	T	W	1.00	\$29,651	N	N
EDN400	11/15/2011	302A-1116, HRS	802571	Cafeteria Helper	N	BC02	01	T	A	0.50	\$16,614	Y	N
EDN400	8/21/2012	302A-1116, HRS	802751	Cafeteria Helper	N	BC02	01	T	A	0.50	\$16,614	N	N
EDN400	8/21/2012	302A-1116, HRS	802752	Cafeteria Helper	N	BC02	01	T	A	0.50	\$16,614	N	N
EDN400	8/21/2012	302A-1116, HRS	802753	Cafeteria Helper	N	BC02	01	T	A	0.50	\$16,614	N	N
EDN400	11/15/2012	302A-1116, HRS	802834	Cafeteria Helper	N	BC02	01	T	N	0.50	\$16,614	Y	N
EDN400	11/15/2012	302A-1116, HRS	802835	Cafeteria Helper	N	BC02	01	T	N	0.50	\$16,614	N	N
EDN400	11/15/2012	302A-1116, HRS	802836	Cafeteria Helper	N	BC02	01	T	N	0.50	\$16,614	N	N
EDN400	11/15/2012	302A-1116, HRS	802841	Cafeteria Helper	N	BC02	01	T	N	0.50	\$16,614	N	N
EDN400	11/15/2012	302A-1116, HRS	802847	Cafeteria Helper	N	BC02	01	T	N	0.50	\$16,614	Y	N
EDN400	11/15/2012	302A-1116, HRS	802848	Cafeteria Helper	N	BC02	01	T	N	0.50	\$16,614	N	N
EDN400	11/15/2012	302A-1116, HRS	802849	Cafeteria Helper	N	BC02	01	T	N	0.50	\$16,614	Y	N
EDN400	11/15/2012	302A-1116, HRS	802850	Food Services Driver	N	BC03	01	T	N	1.00	\$34,164	N	N
EDN400	11/15/2012	302A-1116, HRS	802851	Cafeteria Helper	N	BC02	01	T	N	0.50	\$16,614	N	N
EDN400	11/15/2012	302A-1116, HRS	802852	Cafeteria Helper	N	BC02	01	T	N	0.50	\$16,614	N	N
EDN400	11/15/2012	302A-1116, HRS	802853	Cafeteria Helper	N	BC02	01	T	N	0.50	\$16,614	N	N
EDN400	11/15/2012	302A-1116, HRS	802854	Cafeteria Helper	N	BC02	01	T	N	0.50	\$16,614	N	N
EDN400	11/29/2012	302A-1116, HRS	802865	Cafeteria Helper	N	BC02	01	T	A	0.50	\$16,614	N	N
EDN500	7/1/2000	302A-1116, HRS	48491	Office Assistant III	N	SR08	03	T	W	1.00	\$24,385	Y	N
EDN500	7/1/2000	302A-1116, HRS	48847	Office Assistant III	N	SR08	03	T	W	0.50	\$14,267	Y	N
EDN500	7/1/2006	302A-1116, HRS	59722	Office Assistant III	N	SR08	03	T	W	0.50	\$24,385	Y	Y
EDN500	7/11/2006	302A-1116, HRS	59806	Office Assistant III	N	SR08	03	T	W	0.50	\$12,683	Y	N
EDN500	7/17/2006	302A-1116, HRS	59808	Office Assistant III	N	SR08	03	T	W	1.00	\$24,385	Y	N
EDN500	12/8/2006	302A-1116, HRS	59925	Program Specialist IV	N	SR22	13	T	W	1.00	\$43,297	Y	N
EDN500	7/10/2007	302A-1116, HRS	800752	Account Clerk III	N	SR11	03	T	W	1.00	\$27,394	N	N
EDN500	10/7/2011	302A-1116, HRS	802397	Office Assistant III	N	SR08	03	T	W	0.50	\$12,192	Y	N

Department of Education
Overtime Expenditures

Table 18

Prog ID	Program Title	MOF	FY12 (actual)			FY13 (actual)			FY14 (estimated)*			FY15 (budgeted)**		
			Base Salary \$\$\$\$	Overtime \$\$\$\$	Overtime Percent	Base Salary \$\$\$\$	Overtime \$\$\$\$	Overtime Percent	Base Salary \$\$\$\$	Overtime \$\$\$\$	Overtime Percent	Base Salary \$\$\$\$	Overtime \$\$\$\$	Overtime Percent
EDN100	SCHOOL BASED BUDGETING	A	\$ 693,422,756	\$ 939,857	0.14%	\$ 698,569,356	\$ 854,995	0.12%	\$ 723,396,817	\$ 806,314	0.11%	\$ 661,459,109	\$ -	0.00%
EDN100	SCHOOL BASED BUDGETING	B	\$ 597,407	\$ 16,063	2.69%	\$ 535,768	\$ 27,634	5.16%	\$ 873,051	\$ 22,898	2.62%	\$ -	\$ -	#DIV/0!
EDN100	SCHOOL BASED BUDGETING	N	\$ 30,776,021	\$ 55,624	0.18%	\$ 30,229,469	\$ 66,019	0.22%	\$ 23,921,862	\$ 47,488	0.20%	\$ -	\$ -	#DIV/0!
EDN100	SCHOOL BASED BUDGETING	P							\$ 238,936			\$ -		
EDN100	SCHOOL BASED BUDGETING	T	\$ 1,627,636	\$ 9,408	0.58%	\$ 1,613,434	\$ 11,608	0.72%	\$ 1,679,595	\$ 15,803	0.94%	\$ -	\$ -	#DIV/0!
EDN100	SCHOOL BASED BUDGETING	U	\$ 622,556	\$ -	0.00%	\$ 643,900	\$ -	0.00%	\$ 539,764	\$ 3,510	0.65%	\$ -	\$ -	#DIV/0!
EDN100	SCHOOL BASED BUDGETING	V	\$ 2,244,938	\$ 15,588	0.69%	\$ 286,401	\$ -	0.00%	\$ 213,297	\$ -	0.00%	\$ -	\$ -	#DIV/0!
EDN100	SCHOOL BASED BUDGETING	W	\$ 299,354	\$ -	0.00%	\$ 367,029	\$ -	0.00%	\$ 341,639	\$ -	0.00%	\$ -	\$ -	#DIV/0!
EDN150	COMPREHENSIVE STUDENT SUPPORT SERVICES	A	\$ 250,165,358	\$ 37,376	0.01%	\$ 250,339,097	\$ 22,841	0.01%	\$ 262,656,171	\$ 13,898	0.01%	\$ 265,824,847	\$ -	0.00%
EDN150	COMPREHENSIVE STUDENT SUPPORT SERVICES	N	\$ 17,969,207	\$ 4,680	0.03%	\$ 18,766,565	\$ 3,338	0.02%	\$ 18,253,761	\$ 1,694	0.08%	\$ 2,030,377	\$ -	0.00%
EDN150	COMPREHENSIVE STUDENT SUPPORT SERVICES	P							\$ -	\$ -	0.00%	\$ 76,788	\$ -	0.00%
EDN150	COMPREHENSIVE STUDENT SUPPORT SERVICES	V	\$ 263,361	\$ 710	0.27%	\$ -	\$ -	#DIV/0!	\$ -	\$ -	#DIV/0!	\$ -	\$ -	#DIV/0!
EDN150	COMPREHENSIVE STUDENT SUPPORT SERVICES	W	\$ 107,101	\$ -	0.00%	\$ 107,103	\$ -	0.00%	\$ 113,746	\$ -	0.00%	\$ 203,892	\$ -	0.00%
EDN200	INSTRUCTIONAL SUPPORT	A	\$ 24,056,113	\$ 8,480	0.04%	\$ 23,680,741	\$ 5,387	0.02%	\$ 26,238,423	\$ 4,920	0.02%	\$ 25,631,236	\$ -	0.00%
EDN200	INSTRUCTIONAL SUPPORT	B	\$ 302,343	\$ 55	0.02%	\$ 484,951	\$ -	0.00%	\$ 517,697	\$ 7,365	1.42%	\$ 561,744	\$ -	0.00%
EDN200	INSTRUCTIONAL SUPPORT	N	\$ 252,506	\$ -	0.00%	\$ 244,959	\$ -	0.00%	\$ 252,870	\$ -	0.00%	\$ 147,469	\$ -	0.00%
EDN200	INSTRUCTIONAL SUPPORT	P							\$ -	\$ -	#DIV/0!	\$ 109,099	\$ -	0.00%
EDN200	INSTRUCTIONAL SUPPORT	U	\$ 60,326	\$ -	0.00%	\$ 57,708	\$ -	0.00%	\$ 61,995	\$ -	0.00%	\$ -	\$ -	#DIV/0!
EDN200	INSTRUCTIONAL SUPPORT	V	\$ 3,074,163	\$ -	0.00%	\$ 6,276,806	\$ -	0.00%	\$ 5,588,342	\$ -	0.00%	\$ -	\$ -	#DIV/0!
EDN300	STATE AND COMPLEX AREA ADMINISTRATION	A	\$ 21,121,041	\$ 303,512	1.44%	\$ 22,159,243	\$ 309,467	1.40%	\$ 23,182,066	\$ 412,148	1.78%	\$ 23,774,525	\$ 20,750	0.09%
EDN300	STATE AND COMPLEX AREA ADMINISTRATION	N	\$ 183,760	\$ -	0.00%	\$ 159,321	\$ 33	0.02%	\$ 59,198	\$ -	0.00%	\$ -	\$ -	#DIV/0!
EDN400	SCHOOL SUPPORT	A	\$ 43,837,441	\$ 142,207	0.32%	\$ 43,766,166	\$ 160,559	0.37%	\$ 29,323,954	\$ -	0.00%	\$ 23,917,220	\$ -	0.00%
EDN400	SCHOOL SUPPORT	B	\$ 427,630	\$ 37,052	8.66%	\$ 980,592	\$ 58,074	5.92%	\$ 17,400,658	\$ -	0.00%	\$ 26,443,314	\$ -	0.00%
EDN400	SCHOOL SUPPORT	N	\$ 3,874,913	\$ 83,131	2.15%	\$ 3,757,527	\$ 136,677	3.64%	\$ 2,523,781	\$ -	0.00%	\$ 4,025,034	\$ -	0.00%
EDN400	SCHOOL SUPPORT	W	\$ 107,527	\$ -	0.00%	\$ 121,797	\$ 34,017	27.93%	\$ 92,067	\$ -	0.00%	\$ 200,796	\$ -	0.00%
EDN500	SCHOOL COMMUNITY SERVICES	A	\$ 4,180,779	\$ 36,382	0.87%	\$ 2,340,417	\$ 49,646	2.12%	\$ 2,129,291	\$ 61,336	2.88%	\$ 1,981,042	\$ -	0.00%
EDN500	SCHOOL COMMUNITY SERVICES	B	\$ 350,987	\$ 3,269	0.93%	\$ 227,568	\$ 12,490	5.49%	\$ 219,474	\$ 3,429	1.56%	\$ -	\$ -	#DIV/0!
EDN500	SCHOOL COMMUNITY SERVICES	N	\$ 1,432,695	\$ 5,498	0.38%	\$ 1,221,102	\$ -	0.00%	\$ 1,246,280	\$ -	0.00%	\$ 131,719	\$ -	0.00%
EDN500	SCHOOL COMMUNITY SERVICES	U	\$ -	\$ 5,038	#DIV/0!	\$ -	\$ -	#DIV/0!	\$ 354	\$ -	#DIV/0!	\$ -	\$ -	#DIV/0!
EDN500	SCHOOL COMMUNITY SERVICES	W	\$ 3,402,515	\$ 67,196	1.97%	\$ 3,439,543	\$ 59,853	1.74%	\$ 2,591,773	\$ 45,059	1.74%	\$ -	\$ -	#DIV/0!
EDN600	PUBLIC CHARTER SCHOOLS	A	\$ 10,807,074	\$ 9,742	0.09%	\$ 9,992,166	\$ 723	0.01%	\$ 10,423,968	\$ -	0.00%	\$ -	\$ -	#DIV/0!
TOTAL			\$ 1,115,567,509	\$ 1,780,867		\$ 1,120,368,729	\$ 1,813,361		\$ 1,154,080,477	\$ 1,446,216		\$ 1,036,518,211	\$ 20,750	
* FY14 estimated amount based on Base Salary and Overtime expenditure data as of December 20, 2013, multiplied by 2														
** FY 15 budgeted amount based on permanent and temporary position budgeted salary and overtime amounts as provided in the Department's FY 15 Supplemental Budget														

Department of Education
Overpayments

Table 19

Employee Name	Date of Overpayment	Gross Amount Overpaid	Amount Recovered	Balance	Category				Reason for Overpayment	Referred to Attorney General
					Employed		Not Employed			
					Occurred > 2 Years	Occurred < 2 Years	Occurred > 2 Years	Occurred < 2 Years		
	11/9/10-1/3/11	4,133.41	3,000.00	1,133.41		1,133.41			Paid while on LWOP	no
	2/5/03-8/20/03	877.62	0.00	877.62			877.62		Paid while on LWOP	no
	01/18/08	1,065.19	120.00	945.19			945.19		Paid while on LWOP	no
	5/20/10-7/20/10	764.18	750.00	14.18		14.18			Paid while on LWOP	no
	1/3-2/13/12	870.06	375.00	495.06			495.06		Paid while on LWOP	no
	10/24/03	2,727.98	0.00	2,727.98			2,727.98		Paid while on LWOP	no
	12/20/01-8/5/02	727.65	0.00	727.65			727.65		Paid while on LWOP	no
	10/25/99	1,568.60	0.00	1,568.60			1,568.60		Paid while on LWOP	no
	5/20/05-6/30/05	593.96	0.00	593.96			593.96		Paid while on LWOP	no
	12/20/05	1,237.85	0.00	1,237.85			1,237.85		Paid while on LWOP	no
	09/20/01	2,753.26	0.00	2,753.26		2,753.26			Paid yr round instead of trad	no
	07/02/12	945.01	575.00	370.01	370.01				Paid after transfer from 100% to 50%	no
	10/08/08	4,981.70	0.00	4,981.70		4,981.70			Paid while on LWOP	no
	3/4/11-7/20/11	6,435.98	3,280.53	3,155.45			3,155.45		Paid 11 days twice/repay pp	no
	05/01/01	2,889.54	749.15	2,140.39			2,140.39		Paid while on LWOP	no
	08/20/12	527.98	0.00	527.98			527.98		Paid after resignation	no
	01/28/00	1,539.51	0.00	1,539.51		1,539.51			Paid while on LWOP	no
	06/10/09	3,526.11	0.00	3,526.11			3,526.11		Paid after termination	no
	6/23/11-11/30/11	12,852.14	2,000.00	10,852.14		10,852.14			Paid while on LWOP	no
	03/05/01	2,375.98	0.00	2,375.98			2,375.98		Paid after resignation	no
	08/29/01	614.80	0.00	614.80			614.80		Paid while on LWOP	no
	06/05/03	192.46	0.00	192.46			192.46		Paid while on LWOP	no
	12/05/05	13,080.82	0.00	13,080.82		13,080.82			Paid while on LWOP	no
	06/18/04	642.99	0.00	642.99			642.99		Paid while on LWOP	no
	8/19/10-10/20/10	6,716.45	4,900.00	1,816.45		1,816.45			Paid at wrong FTE	no
	08/20/02	6,876.93	2,000.00	4,876.93		4,876.93			Paid after resignation	no
	02/15/02	1,155.72	0.00	1,155.72		1,155.72			Paid while on LWOP	no
	11/20/07	1,764.29	0.00	1,764.29			1,764.29		Paid while on LWOP	no
	05/28/04	584.25	0.00	584.25		584.25			Paid while on LWOP	no
	10/20/03	819.20	0.00	819.20			819.20		Paid while on LWOP	no
	07/20/03	206.12	175.00	31.12			31.12		Paid while on LWOP	no
	2/9/11-2/22/11	2,068.26	1,800.00	268.26		268.26			Paid while on LWOP	no
	2/5/07-8/3/07	2,419.85	0.00	2,419.85		2,419.85			Paid while on LWOP	no
	12/01/11	4,071.70	0.00	4,071.70	4,071.70				Paid while on LWOP	no
	04/10/00	6,359.01	0.00	6,359.01		6,359.01			Paid while on LWOP	no
	7/11/11 - 1/24/12	6,888.06	150.00	6,738.06			6,738.06		Paid after termination	no
	08/19/10	967.50	900.00	67.50			67.50		Paid after termination	no
	07/18/03	2,240.65	0.00	2,240.65		2,240.65			Paid while on LWOP	no
	8/23/11-6/30/12	1,482.67	0.00	1,482.67			1,482.67		Paid while on LWOP	no

Department of Education
Overpayments

Table 19

<u>Employee Name</u>	<u>Date of Overpayment</u>	<u>Gross Amount Overpaid</u>	<u>Amount Recovered</u>	<u>Balance</u>	<u>Occurred > 2 Years</u>	<u>Occurred < 2 Years</u>	<u>Occurred > 2 Years</u>	<u>Occurred < 2 Years</u>	<u>Reason for Overpayment</u>	<u>Referred to Attorney General</u>
	6/12-7/8/12	659.65	175.00	484.65			484.65		Paid while on LWOP	no
	4/9-4/15/12	329.64	0.00	329.64			329.64		Paid while on LWOP	no
	04/20/07	638.04	0.00	638.04				638.04	Paid while on LWOP	no
	03/19/09	2,748.25	0.00	2,748.25		2,748.25			Paid while on LWOP	no
	08/19/10	2,438.14	0.00	2,438.14				2,438.14	Paid while on LWOP	no
	05/21/04	2,400.51	0.00	2,400.51				2,400.51	Paid while on LWOP	no
	06/20/12	200.00	175.00	25.00	25.00				Paid in error	no
	7/29/11-9/15/11	2,142.68	100.00	2,042.68		2,042.68			Paid while in two positions	no
	8/20/01-9/20/01	3,205.98	0.00	3,205.98				3,205.98	Paid while on LWOP	no
	08/03/10	856.82	0.00	856.82				856.82	Paid while on LWOP	no
	3/5/10-9/21/11	15,858.08	0.00	15,858.08		15,858.08			Paid while on LWOP	no
	01/05/05	599.90	0.00	599.90				599.90	Paid but did not work	no
	07/21/12	1,299.41	0.00	1,299.41			1,299.41		Paid after resignation	no
	4/1/11-7/22/11	5,532.24	3,200.00	2,332.24		2,332.24			Paid while on LWOP	no
	08/18/11	686.40	425.00	261.40				261.40	Paid after termination	no
	08/17/06	720.11	0.00	720.11				720.11	Paid while on LWOP	no
	8/1/11-7/26/12	323.13	52.64	270.49		270.49			Paid while on LWOP	no
	9/15/10-1/3/11	3,109.47	800.00	2,309.47				2,309.47	Paid while on LWOP	no
	11/4/11-12/20/11	8,851.59	3,400.00	5,451.59		5,451.59			Paid while on LWOP	no
	03/20/01	843.18	0.00	843.18				843.18	Paid while on LWOP	no
	10/06/00	843.18	300.00	543.18				543.18	Paid while on LWOP	no
	05/22/08	1,116.10	0.00	1,116.10				1,116.10	Paid while on LWOP	no
	05/22/09	839.50	0.00	839.50		839.50			Paid while on LWOP	no
	8/18/11-9/2/11	4,590.58	3,800.00	790.58		790.58			Paid while on LWOP	no
	07/27/11	5,430.74	3,375.00	2,055.74		2,055.74			Paid after resignation	no
	2/20/01-3/20/01	968.87	925.00	43.87		43.87			Paid while on LWOP	no
	9/9/10-12/13/10	3,406.92	0.00	3,406.92				3,406.92	Paid while on LWOP	no
	5/18-27/11	2,327.53	2,300.00	27.53		27.53			Paid while on LWOP	no
	5/27-7/22/11	7,947.22	1,100.00	6,847.22				6,847.22	Paid while on LWOP	no
	12/05/00	1,546.53	0.00	1,546.53				1,546.53	Paid while on LWOP	no
	08/19/04	99.85	0.00	99.85				99.85	Paid over 150 hours of summer school	no
	07/28/10	793.72	300.00	493.72				493.72	Paid after resignation	no
	01/20/04	322.02	0.00	322.02		322.02			Paid while on LWOP	no
	05/04/04	1,141.74	0.00	1,141.74				1,141.74	Paid while on LWOP	no
	05/19/11	6,152.02	2,300.00	3,852.02		3,852.02			Paid while on LWOP	no
	11/09/04	12,902.06	5,150.36	7,751.70		7,751.70			Paid incorrect rate	no
	07/05/12	2,010.79	750.00	1,260.79	1,260.79				Paid in error	no
	10/22/09	4,425.30	1,600.00	2,825.30				2,825.30	Paid after resignation	no
	03/17/04	808.52	600.00	208.52		208.52			Paid while on LWOP	no
	02/11/08	4,583.01	2,625.00	1,958.01				1,958.01	Paid after resignation	no
	7/26/11-1/3/12	19,451.93	3,200.00	16,251.93				16,251.93	Did not return after sabbatical	no

Department of Education
Overpayments

Table 19

<u>Employee Name</u>	<u>Date of Overpayment</u>	<u>Gross Amount Overpaid</u>	<u>Amount Recovered</u>	<u>Balance</u>	<u>Occurred > 2 Years</u>	<u>Occurred < 2 Years</u>	<u>Occurred > 2 Years</u>	<u>Occurred < 2 Years</u>	<u>Reason for Overpayment</u>	<u>Referred to Attorney General</u>
	10/3/08-11/5/08	4,039.81	0.00	4,039.81				4,039.81	Paid while on LWOP	no
	06/27/05	1,402.91	0.00	1,402.91				1,402.91	Paid while on LWOP	no
	08/12/09	8,641.95	0.00	8,641.95		8,641.95			Paid while on industrial leave	no
	8/23/10-9/15/10	1,745.92	0.00	1,745.92		1,745.92			Paid while on LWOP	no
	01/22/02	958.32	0.00	958.32				958.32	Paid but did not work	no
	3/26/12-6/11/12	520.17	0.00	520.17			520.17		Paid after retirement	no
	06/20/12	965.62	625.00	340.62			340.62		Paid double summer salary in error	no
	1/4-3/15/13	3,976.24	662.70	3,313.54	3,313.54				Paid while on LWOP	no
	05/28/10	1,784.04	751.58	1,032.46				1,032.46	Paid after resignation	no
	09/20/04	2,626.80	1,400.00	1,226.80				1,226.80	Paid while on LWOP	no
	03/06/97	4,291.78	0.00	4,291.78		4,291.78			Paid while on LWOP	no
	1/20/10-2/19/10	4,637.74	3,900.00	737.74				737.74	Paid while on LWOP	no
	12/07/10	891.82	0.00	891.82				891.82	Paid after resignation	no
	08/27/02	1,717.03	0.00	1,717.03				1,717.03	Paid while on LWOP	no
	05/04/05	962.96	0.00	962.96		962.96			Paid while on LWOP	no
	07/28/09	4,414.00	0.00	4,414.00				4,414.00	Paid while on LWOP	no
	07/26/11	241.29	0.00	241.29				241.29	Paid while on LWOP	no
	10/01/10	1,899.04	0.00	1,899.04				1,899.04	Paid while on LWOP	no
	12/20/01	8,247.61	0.00	8,247.61				8,247.61	Paid while on LWOP	no
	9/12/11-10/31/11	4,656.95	0.00	4,656.95		4,656.95			Paid while on LWOP	no
	08/15/92	1,178.97	0.00	1,178.97				1,178.97	Paid while on LWOP	no
	08/20/07	866.88	433.44	433.44		433.44			Paid after termination	no
		308,364.64	65,200.40	243,164.24	9,041.04	119,403.95	3,997.53	110,721.72		no Total
	10/20/06	113.75	0.00	113.75				113.75	Paid while on LWOP	Yes
	05/20/08	266.16	0.00	266.16				266.16	Paid while on LWOP	Yes
	10/05/09	224.00	0.00	224.00				224.00	Additional hours paid in error	Yes
	08/20/07	1,240.20	0.00	1,240.20				1,240.20	Paid incorrect summer salary	Yes
	12/19/08-8/5/09	2,232.02	1,259.87	972.15				972.15	Paid after resignation	Yes
	03/20/08	167.26	0.00	167.26				167.26	Paid after resignation	Yes
	07/20/06 - 01/05/07	2,542.64	2,050.89	491.75				491.75	Paid while on LWOP	Yes
	2/4/05-2/18/05	1,177.16	1,000.00	177.16				177.16	Paid while on LWOP	Yes
	11/18/05-12/20/05	1,266.54	0.00	1,266.54				1,266.54	Paid while on LWOP	Yes
	08/17/06	1,849.42	759.00	1,090.42				1,090.42	Paid after resignation	Yes
	08/20/07	1,005.29	0.00	1,005.29				1,005.29	Paid but did not work	Yes
	08/20/12	357.67	0.00	357.67			357.67		Paid after resignation	Yes
	06/18/04	178.58	0.00	178.58				178.58	Paid while on LWOP	Yes
	05/18/07	414.82	150.00	264.82				264.82	Paid while on LWOP	Yes
	3/5/08-8/5/08	1,300.32	125.32	1,175.00				1,175.00	Paid while on LWOP	Yes
	06/04/04	186.32	0.00	186.32				186.32	Paid while on LWOP	Yes
	10/9-15/12	2,353.60	1,200.00	1,153.60			1,153.60		Paid twice in error	Yes
	10/03/08	120.00	0.00	120.00				120.00	Casual Hrs in error	Yes

Department of Education
Overpayments

Table 19

<u>Employee Name</u>	<u>Date of Overpayment</u>	<u>Gross Amount Overpaid</u>	<u>Amount Recovered</u>	<u>Balance</u>	<u>Occurred > 2 Years</u>	<u>Occurred < 2 Years</u>	<u>Occurred > 2 Years</u>	<u>Occurred < 2 Years</u>	<u>Reason for Overpayment</u>	<u>Referred to Attorney General</u>
	05/05/10	465.08	200.00	265.08				265.08	SASA inputted into wrong acct code	Yes
	07/26/12	2,170.29	50.00	2,120.29			2,120.29		Paid after resignation	Yes
	02/03/06 - 09/05/0	5,240.31	0.00	5,240.31				5,240.31	Paid while on LWOP	Yes
	08/17/00	73.58	0.00	73.58				73.58	Paid while on LWOP	Yes
	4/20/09-6/19/09	623.16	250.00	373.16				373.16	Paid while on LWOP	Yes
	12/20/06-8/3/07	1,158.91	0.00	1,158.91				1,158.91	Paid while on LWOP	Yes
	12/31/11	2,627.01	603.01	2,024.00			2,024.00		Paid after retirement	Yes
	02/09/04	332.14	0.00	332.14				332.14	Paid while on LWOP	Yes
	2/23/01-5/25/01	478.95	55.00	423.95				423.95	Paid while on LWOP	Yes
	08/29/12	435.39	150.00	285.39			285.39		Paid after resignation	Yes
	08/19/10	1,907.71	700.00	1,207.71				1,207.71	Paid twice in error	Yes
	02/09/00	1,036.94	504.00	532.94				532.94	Paid while on LWOP	Yes
	06/20/05	103.65	0.00	103.65				103.65	Paid while on LWOP	Yes
	10/20/03-11/5/03	1,620.54	0.00	1,620.54				1,620.54	Paid while on LWOP	Yes
	05/03/10	152.86	0.00	152.86				152.86	Paid while on LWOP	Yes
	3/19/04-4/5/04	1,038.78	0.00	1,038.78				1,038.78	Paid while on LWOP	Yes
	5/20/05-6/30/05	276.36	0.00	276.36				276.36	Paid while on LWOP	Yes
	9/20/04-1/20/05	18,732.42	0.00	18,732.42				18,732.42	Paid while on LWOP	Yes
	12/15/98	265.86	140.00	125.86				125.86	Paid while on LWOP	Yes
	04/08/08	152.11	75.00	77.11				77.11	Paid while on LWOP	Yes
	11/05/04	1,154.76	0.00	1,154.76				1,154.76	Paid while on LWOP	Yes
	02/05/09	56.95	0.00	56.95				56.95	Another employee sign 5 hrs under your	Yes
	6/20/08-10/20/08	58.61	0.00	58.61				58.61	Paid while on LWOP	Yes
	6/5/08-8/5/08	239.09	0.00	239.09				239.09	Paid while on LWOP	Yes
	05/05/04	483.03	0.00	483.03				483.03	Paid while on LWOP	Yes
	6/20/05-7/5/05	370.68	0.00	370.68				370.68	Paid while on LWOP	Yes
	8/19/04-8/5/05	3,650.26	0.00	3,650.26				3,650.26	Paid after resignation	Yes
	12/20/01 - 08/05/0	2,908.84	0.00	2,908.84				2,908.84	Paid while on LWOP	Yes
	07/19/02	1,458.13	0.00	1,458.13				1,458.13	Paid while on LWOP	Yes
	02/19/99 - 04/05/9	1,194.20	0.00	1,194.20				1,194.20	Paid while on LWOP	Yes
	8/5/99-9/30/99	416.32	0.00	416.32				416.32	Paid while on LWOP	Yes
	11/19/99 - 04/20/0	5,497.15	4,389.12	1,108.03				1,108.03	Paid while on LWOP	Yes
	11/5/10-8/18/11	40,621.80	5,380.70	35,241.10				35,241.10	Paid after termination	Yes
	08/18/11	848.69	0.00	848.69				848.69	Paid after resignation	Yes
	11/20/03-8/5/04	2,225.99	0.00	2,225.99				2,225.99	Paid while on LWOP	Yes
	12/20/07	1,375.00	200.00	1,175.00				1,175.00	Paid incorrect # of days	Yes
	1/4/02-1/18/02	3,961.38	0.00	3,961.38		3,961.38			Paid after resignation	Yes
	3/20/03-10/20/06	3,634.23	1,000.49	2,633.74				2,633.74	Paid while on LWOP	Yes
	12/20/07-3/5/08	7,065.29	1,200.00	5,865.29				5,865.29	Paid while on LWOP	Yes
	12/20/10	884.11	0.00	884.11				884.11	Paid while on LWOP	Yes
	09/05/08	465.00	0.00	465.00				465.00	Paid while on LWOP	Yes

Department of Education
Overpayments

Table 19

<u>Employee Name</u>	<u>Date of Overpayment</u>	<u>Gross Amount Overpaid</u>	<u>Amount Recovered</u>	<u>Balance</u>	<u>Occurred > 2 Years</u>	<u>Occurred < 2 Years</u>	<u>Occurred > 2 Years</u>	<u>Occurred < 2 Years</u>	<u>Reason for Overpayment</u>	<u>Referred to Attorney General</u>
	09/05/06	362.62	0.00	362.62				362.62	Paid while on LWOP	Yes
	6/3/05-9/2/05	136.37	0.00	136.37				136.37	Paid while on LWOP	Yes
	04/19/02 - 07/05/0	823.69	0.00	823.69				823.69	Paid while on LWOP	Yes
	9/5/07-9/20/07	100.00	0.00	100.00				100.00	Paid while on LWOP	Yes
	03/21/12	594.10	0.00	594.10			594.10		Paid after resignation	Yes
	3/03/00 to 06/05/0	597.10	0.00	597.10				597.10	Paid while on LWOP	Yes
	11/14/00 - 1/5/01	2,452.23	1,778.41	673.82				673.82	Paid after resignation	Yes
	6/4/04-6/19/04	585.68	0.00	585.68				585.68	Paid while on LWOP	Yes
	08/20/02	1,750.00	0.00	1,750.00				1,750.00	Failed Agreement - Teacher Relocation	Yes
	07/31/08	706.82	150.00	556.82				556.82	Paid while on LWOP	Yes
	08/19/10	1,254.54	400.00	854.54				854.54	Paid twice in error	Yes
	08/18/11	955.92	0.00	955.92				955.92	Paid after resignation	Yes
	08/03/07	991.32	912.22	79.10				79.10	Paid incorrect number of hours	Yes
	4/20/07-8/3/07	768.19	0.00	768.19				768.19	Paid while on LWOP	Yes
	08/05/11	2,195.57	0.00	2,195.57				2,195.57	Paid after resignation	Yes
	06/14/06	1,140.15	50.00	1,090.15				1,090.15	Paid while on LWOP	Yes
	06/18/10	78.22	0.00	78.22				78.22	Uncoverable EUTF	Yes
	8/20-9/5/12	4,194.50	0.00	4,194.50			4,194.50		Paid after resignation	Yes
	05/05/00 - 08/04/0	1,430.91	0.00	1,430.91				1,430.91	Paid while on LWOP	Yes
	09/02/05 - 09/20/0	2,121.64	0.00	2,121.64				2,121.64	Paid after termination	Yes
	6/18/04-2/17/06	5,352.02	1,000.00	4,352.02				4,352.02	Paid while on LWOP	Yes
	4/20/07-8/3/07	2,281.50	200.00	2,081.50				2,081.50	Paid while on LWOP	Yes
	04/05/05	124.83	0.00	124.83				124.83	Paid while on LWOP	Yes
	5/18/07-6/5/07	372.90	0.00	372.90				372.90	Paid while on LWOP	Yes
	09/20/06	1,296.26	100.00	1,196.26				1,196.26	Paid after resignation	Yes
	9/14/10-9/20/10	364.45	0.00	364.45				364.45	Paid while on LWOP	Yes
	08/05/08	216.72	0.00	216.72				216.72	Paid while on LWOP	Yes
	08/20/03	1,634.71	0.00	1,634.71				1,634.71	Paid but did not work	Yes
	8/19/04-12/20/04	12,307.97	0.00	12,307.97				12,307.97	Paid while on LWOP	Yes
	09/08/98	2,713.03	0.00	2,713.03				2,713.03	Paid but did not work	Yes
	9/28/11-11/30/11	66.74	0.00	66.74				66.74	Paid while on LWOP	Yes
	1/20/04-9/3/04	2,651.13	2,200.00	451.13				451.13	Paid while on LWOP	Yes
	6/5/08-8/5/08	239.08	0.00	239.08				239.08	Paid while on LWOP	Yes
	11/08/95	1,050.81	970.81	80.00				80.00	Paid while on LWOP	Yes
	09/20/02	1,387.29	0.00	1,387.29				1,387.29	Paid after resignation	Yes
	11/5/04-10/20/05	1,469.48	0.00	1,469.48				1,469.48	Paid while on LWOP	Yes
	08/22/08	381.87	0.00	381.87				381.87	Paid while on LWOP	Yes
	1/05/1998 -02/05/9	2,195.52	750.00	1,445.52				1,445.52	Paid while on LWOP	Yes
	05/05/05	373.81	0.00	373.81				373.81	Paid while on LWOP	Yes
	11/19/98	513.64	488.64	25.00				25.00	Paid while on LWOP	Yes
	10/20/08-11/5/08	1,169.13	0.00	1,169.13				1,169.13	Paid while on LWOP	Yes

Department of Education
Overpayments

Table 19

<u>Employee Name</u>	<u>Date of Overpayment</u>	<u>Gross Amount Overpaid</u>	<u>Amount Recovered</u>	<u>Balance</u>	<u>Occurred > 2 Years</u>	<u>Occurred < 2 Years</u>	<u>Occurred > 2 Years</u>	<u>Occurred < 2 Years</u>	<u>Reason for Overpayment</u>	<u>Referred to Attorney General</u>
	2/5/09-3/5/09	1,155.35	0.00	1,155.35				1,155.35	Paid while on LWOP	Yes
	08/27/11	217.66	25.00	192.66				192.66	Paid after resignation	Yes
	11/20/99	141.42	0.00	141.42				141.42	Paid while on LWOP	Yes
	08/17/06	370.78	0.00	370.78				370.78	Paid after termination	Yes
	03/19/04	131.81	0.00	131.81				131.81	Paid while on LWOP	Yes
	9/20/04-5/19/06	12,929.21	0.00	12,929.21				12,929.21	Downgrade in salary	Yes
	05/05/11	44.77	0.00	44.77				44.77	Paid while on LWOP	Yes
	05/04/10	7,775.23	0.00	7,775.23				7,775.23	Paid while on LWOP	Yes
	06/05/08	206.69	0.00	206.69				206.69	Paid while on LWOP	Yes
	2/5/02-3/5/02	169.72	0.00	169.72				169.72	Paid while on LWOP	Yes
	3/5/04-3/19/04	1,123.56	0.00	1,123.56				1,123.56	Paid while on LWOP	Yes
	12/3/04-1/20/05	2,463.36	0.00	2,463.36				2,463.36	Paid while on LWOP	Yes
	1/19/12-7/25/12	4,815.61	0.00	4,815.61			4,815.61		Paid while on LWOP	Yes
	03/09/09	213.95	0.00	213.95				213.95	Paid while on LWOP	Yes
	08/12/03	1,440.48	0.00	1,440.48				1,440.48	Paid while on LWOP	Yes
	08/13/02	1,453.89	1,153.89	300.00				300.00	Paid while on LWOP	Yes
	02/10/12	899.25	0.00	899.25			899.25		Paid while on LWOP	Yes
	2/19/03 - 06/05/0	1,675.85	0.00	1,675.85				1,675.85	Paid while on LWOP	Yes
	1/20/05-8/5/05	2,052.85	0.00	2,052.85				2,052.85	Paid while on LWOP	Yes
	08/20/08	2,273.21	1,400.00	873.21				873.21	Paid while on LWOP	Yes
	7/25/12-7/24/13	943.15	0.00	943.15			943.15		Paid while on LWOP	Yes
	01/20/05	132.43	0.00	132.43				132.43	Paid while on LWOP	Yes
	08/04/12	82.99	0.00	82.99			82.99		Paid after resignation	Yes
	02/03/06 - 02/17/0	1,032.05	0.00	1,032.05				1,032.05	Paid while on LWOP	Yes
	05/17/02	2,067.62	100.00	1,967.62				1,967.62	Paid while on LWOP	Yes
	02/08/05	501.57	0.00	501.57				501.57	Paid while on LWOP	Yes
	06/05/05 - 08/05/0	1,986.80	380.00	1,606.80				1,606.80	Paid while on LWOP	Yes
	11/3/06-12/5/06	1,386.89	200.00	1,186.89				1,186.89	Paid while on LWOP	Yes
	05/26/10	207.72	0.00	207.72				207.72	Paid while on LWOP	Yes
	05/05/05 -08/05/0	329.27	0.00	329.27				329.27	Paid while on LWOP	Yes
	11/03/03	173.13	0.00	173.13				173.13	Paid while on LWOP	Yes
	05/05/04	1,066.52	0.00	1,066.52				1,066.52	Paid while on LWOP & after term	Yes
	10/11/04	2,296.28	0.00	2,296.28				2,296.28	Paid while on LWOP	Yes
	05/27/11	223.29	0.00	223.29				223.29	Paid while on LWOP	Yes
	01/15/92 - 10/15/9	9,142.08	1,596.00	7,546.08				7,546.08	Paid incorrect W/C	Yes
	07/27/02	1,644.94	0.00	1,644.94				1,644.94	Paid after resignation	Yes
	01/20/05	727.76	0.00	727.76				727.76	Paid incorrect salary	Yes
	01/17/08	10,676.47	130.00	10,546.47				10,546.47	Paid while on LWOP	Yes
	09/20/05 - 11/20/0	860.88	0.00	860.88				860.88	Downgrade in salary	Yes
	10/24/07	54.77	0.00	54.77				54.77	Paid while on LWOP	Yes
	05/29/07	233.13	0.00	233.13				233.13	Paid while on LWOP	Yes

Department of Education
Overpayments

Table 19

<u>Employee Name</u>	<u>Date of Overpayment</u>	<u>Gross Amount Overpaid</u>	<u>Amount Recovered</u>	<u>Balance</u>	<u>Occurred > 2 Years</u>	<u>Occurred < 2 Years</u>	<u>Occurred > 2 Years</u>	<u>Occurred < 2 Years</u>	<u>Reason for Overpayment</u>	<u>Referred to Attorney General</u>
	06/05/08	445.77	0.00	445.77				445.77	Paid while on LWOP	Yes
	04/20/07	341.32	25.00	316.32				316.32	Paid while on LWOP	Yes
	2/5/02-3/20/02	5,671.03	2,000.00	3,671.03				3,671.03	Paid after termination	Yes
	01/05/05	417.22	0.00	417.22				417.22	Paid while on LWOP	Yes
	9/2/11-7/25/12	18,669.21	0.00	18,669.21				18,669.21	Paid while on LWOP	Yes
	09/15/09	256.00	125.00	131.00				131.00	Additional hours paid in error	Yes
	08/19/10	2,320.51	1,100.00	1,220.51				1,220.51	Paid twice	Yes
	07/28/10	1,428.57	0.00	1,428.57				1,428.57	Paid, did not return to work	Yes
	07/26/07	2,111.35	0.00	2,111.35				2,111.35	Paid while on LWOP	Yes
	08/20/02	764.73	200.00	564.73				564.73	Paid after termination	Yes
	06/20/07	212.25	0.00	212.25		212.25			Paid while on LWOP	Yes
	09/19/03	184.19	0.00	184.19				184.19	Paid while on LWOP	Yes
	02/20/02	6,280.46	0.00	6,280.46				6,280.46	Paid while on LWOP	Yes
	08/19/04	1,584.88	1,304.27	280.61				280.61	Paid after resignation	Yes
	11/20/06	1,221.22	0.00	1,221.22				1,221.22	Paid while on LWOP	Yes
	08/17/06 - 09/05/0	1,797.42	113.00	1,684.42				1,684.42	Paid after resignation	Yes
	09/05/06	7,287.06	0.00	7,287.06				7,287.06	Downgrade in salary	Yes
	03/20/02 - 04/05/0	2,283.34	0.00	2,283.34				2,283.34	Paid after resignation	Yes
	05/06/05	186.91	0.00	186.91				186.91	Paid while on LWOP	Yes
	04/19/02 - 09/20/0	457.56	0.00	457.56		457.56			Paid while on LWOP	Yes
	09/30/03	2,880.96	0.00	2,880.96				2,880.96	Paid while on LWOP	Yes
	02/18/11	1,116.45	0.00	1,116.45				1,116.45	Paid while on LWOP	Yes
	03/16/07	1,659.63	0.00	1,659.63				1,659.63	Paid while on LWOP	Yes
	08/17/00 - 05/09/0	1,629.58	529.10	1,100.48				1,100.48	Paid after retirement	Yes
	11/07/08	1,362.51	0.00	1,362.51				1,362.51	Paid while on LWOP	Yes
	03/13/08	152.10	0.00	152.10				152.10	Paid while on LWOP	Yes
	01/20/97 - 06/20/0	2,962.54	0.00	2,962.54				2,962.54	Paid after termination	Yes
	09/20/04 - 10/20/0	1,302.64	0.00	1,302.64				1,302.64	Paid after resignation	Yes
	01/31/08	1,083.60	0.00	1,083.60				1,083.60	Paid while on LWOP	Yes
	09/20/02	29.08	0.00	29.08				29.08	Paid extra quarter day	Yes
	02/02/98	1,734.57	0.00	1,734.57				1,734.57	Paid while on LWOP	Yes
	02/05/04	346.26	0.00	346.26				346.26	Paid while on LWOP	Yes
	06/05/01	482.20	75.00	407.20				407.20	Paid while on LWOP	Yes
	08/20/01 - 03/20/0	5,318.85	851.36	4,467.49				4,467.49	Paid while on LWOP	Yes
	10/20/06	4,438.62	0.00	4,438.62				4,438.62	Paid after termination	Yes
	12/03/04 - 12/20/0	1,515.75	0.00	1,515.75				1,515.75	Paid while on LWOP	Yes
	03/14/08	2,006.70	0.00	2,006.70				2,006.70	Paid while on LWOP	Yes
	11/05/07	450.05	315.62	134.43				134.43	Paid wrong retro	Yes
	05/03/04	184.19	0.00	184.19				184.19	Paid while on LWOP	Yes
	02/03/06	1,511.53	570.00	941.53				941.53	Paid while on LWOP	Yes
	11/04/05 - 01/20/0	431.86	0.00	431.86				431.86	Paid while on LWOP	Yes

Department of Education
Overpayments

Table 19

<u>Employee Name</u>	<u>Date of Overpayment</u>	<u>Gross Amount Overpaid</u>	<u>Amount Recovered</u>	<u>Balance</u>	<u>Occurred > 2 Years</u>	<u>Occurred < 2 Years</u>	<u>Occurred > 2 Years</u>	<u>Occurred < 2 Years</u>	<u>Reason for Overpayment</u>	<u>Referred to Attorney General</u>
	08/20/07	1,780.92	0.00	1,780.92				1,780.92	Paid after resignation	Yes
	05/05/04	159.96	0.00	159.96				159.96	Paid while on LWOP	Yes
	06/04/04	166.28	0.00	166.28				166.28	Paid while on LWOP	Yes
	12/05/11	135.20	0.00	135.20			135.20		Paid but did not work	Yes
	1/5/07-4/20/09	15,684.61	1,500.00	14,184.61				14,184.61	Paid while on LWOP	Yes
	10/27/03	180.06	0.00	180.06				180.06	Paid while on LWOP	Yes
	10/20/99	2,221.25	1,764.22	457.03				457.03	Downgrade in salary	Yes
	08/19/04 - 09/20/0	5,847.75	4,264.00	1,583.75				1,583.75	Paid on two payrolls	Yes
	09/15/03	1,771.11	0.00	1,771.11		1,771.11			Paid while on LWOP	Yes
	02/05/09	207.72	0.00	207.72				207.72	Paid while on LWOP	Yes
	08/20/07	1,266.60	0.00	1,266.60				1,266.60	Incorrect differential rate	Yes
	11/05/05	132.52	0.00	132.52				132.52	Paid while on LWOP	Yes
	02/27/09	152.86	0.00	152.86				152.86	Paid while on LWOP	Yes
	08/19/09	178.27	0.00	178.27				178.27	Paid while on LWOP	Yes
	09/25/08	3,248.99	75.00	3,173.99				3,173.99	Paid while on LWOP	Yes
	04/07/04	131.81	63.62	68.19				68.19	Paid while on LWOP	Yes
	05/15/98	376.55	0.00	376.55				376.55	Paid after transfer	Yes
	11/20/00	589.00	0.00	589.00				589.00	Paid while on LWOP	Yes
	07/02/09	771.00	0.00	771.00				771.00	Paid at wrong class	Yes
	02/06/09	986.91	150.00	836.91				836.91	Paid while on LWOP	Yes
		395,694.20	50,452.56	345,241.64	0.00	6,402.30	17,605.75	321,233.59		Yes Total
		704,058.84	115,652.96	588,405.88	9,041.04	125,806.25	21,603.28	431,955.31		Grand Total

Department of Education
Capital Improvements Program Requests

Table 21

<u>Prog ID</u>	<u>Prog ID</u> <u>Priority</u>	<u>Dept- Wide</u> <u>Priority</u>	<u>Project Title</u>	<u>MOF</u>	<u>FY14 \$\$\$</u>	<u>FY15 \$\$\$</u>
EDN100	1	1	LUMP SUM CIP - CONDITION, STATEWIDE	C		22,500,000
EDN100	1	1	LUMP SUM CIP - CONDITION, STATEWIDE	A		29,000,000
EDN100	2	2	LUMP SUM CIP - CAPACITY, STATEWIDE	C		1,500,000
EDN100	3	3	LUMP SUM CIP - EQUITY, STATEWIDE	C		14,000,000
EDN100	4	4	LUMP SUM CIP - PROGRAM SUPPORT, STATEWIDE	C		12,000,000
EDN100	5	5	SOLOMON ELEMENTARY SCHOOL, OAHU	C		12,000,000
EDN100	5	5	SOLOMON ELEMENTARY SCHOOL, OAHU	N		48,000,000
EDN100	1	1	LUMP SUM CIP - CONDITION, STATEWIDE (Act 134, SLH 2013)	C		(20,000,000)
EDN100	1	1	LUMP SUM CIP - CONDITION, STATEWIDE (Act 134, SLH 2013)	A		20,000,000
EDN100	2	2	LUMP SUM CIP - CAPACITY, STATEWIDE (Act 134, SLH 2013)	C		(20,000,000)
EDN100	2	2	LUMP SUM CIP - CAPACITY, STATEWIDE (Act 134, SLH 2013)	A		20,000,000
EDN100	3	3	LUMP SUM CIP - EQUITY, STATEWIDE (Act 134, SLH 2013)	C		(10,000,000)
EDN100	3	3	LUMP SUM CIP - EQUITY, STATEWIDE (Act 134, SLH 2013)	A		10,000,000
EDN100	4	4	LUMP SUM CIP - PROGRAM SUPPORT, STATEWIDE (Act 134, SLH 2013)	C		(4,000,000)
EDN100	4	4	LUMP SUM CIP - PROGRAM SUPPORT, STATEWIDE (Act 134, SLH 2013)	A		4,000,000
EDN100	6	6	KAWANANAKOA MIDDLE SCHOOL, OAHU (Act 134, SLH 2013)	C		(5,000,000)
EDN100	6	6	KAWANANAKOA MIDDLE SCHOOL, OAHU (Act 134, SLH 2013)	A		5,000,000
EDN100	7	7	MCKINLEY HIGH SCHOOL, OAHU (Act 134, SLH 2013)	C		(10,000,000)
EDN100	7	7	MCKINLEY HIGH SCHOOL, OAHU (Act 134, SLH 2013)	A		10,000,000
EDN100	8	8	AIR CONDITIONING - STATEWIDE	C		25,000,000
TOTAL					\$	164,000,000
TOTAL BY MOF				A		\$ 98,000,000
				C		\$ 18,000,000
				N		\$ 48,000,000
GRAND TOTAL					\$	164,000,000
Note: Priority of projects are relative to the projects listed on this table.						

Department of Education
Capital Improvements Program Lapses

Table 22

<u>Prog ID</u>	<u>Act/Year of Appropriation</u>	<u>Project Title</u>	<u>MOF</u>	<u>Amount \$\$\$\$</u>	<u>Reason</u>
None.					

Department of Education
Division Resources

Table 23

<u>Division</u>	<u>Associated Program IDs</u>						
Schools	EDN 100	EDN 150	EDN 500				
Complex Areas	EDN 200						
Office of the Superintendent	EDN 200	EDN 300					
Office of Human Resources	EDN 100	EDN 300					
Office of Curriculum, Instruction and Student Support	EDN 100	EDN 150	EDN 200	EDN 500			
Office of Information and Technology Services	EDN 300	EDN 400					
Office of Fiscal Services	EDN 300						
Office of School Facilities and Support Services	EDN 400						

Plan of Organization

Updated as of June 30, 2012

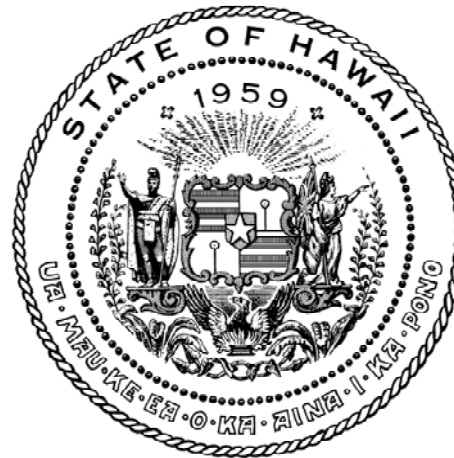

Department of Education
State of Hawaii

Office of Human Resources/Management Support Services Section ~ Department of Education ~ State of Hawaii ~ Revised June 30, 2012

FOREWORD

The Department of Education (DOE) *Plan of Organization* documents the official organization of state and complex area offices of the department, as approved by the Superintendent of Education pursuant to Section 302A-1111, Hawaii Revised Statutes. The *Plan of Organization* describes the organizational structure, supervisory relationships among established positions, and the functions of each state and complex area office in the department. This edition supersedes all previous editions of the DOE *Plan of Organization*.

Any change to the organizational structure, supervisory relationships among established positions, or functional responsibilities described herein must be submitted for approval. Organizational change requests may be initiated at any time by the designated head of the office affected. Offices contemplating an organizational change should inform the Office of Human Resources (OHR), Management Support Services Section.

The *Plan of Organization* shall be updated annually to reflect routine changes in the titles, numbers, and salary ranges of established positions. OHR will coordinate the annual update. OHR shall maintain the *Plan of Organization* and distribute the annual update and any intervening approved organizational changes to all holders of the *Plan*.

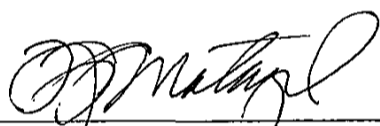

Kathryh S. Matayoshi
Superintendent of Education

June 30, 2012

Department of Education
Organizational Chart

Table 24

STATE OF HAWAII
DEPARTMENT OF EDUCATION
ORGANIZATION CHART

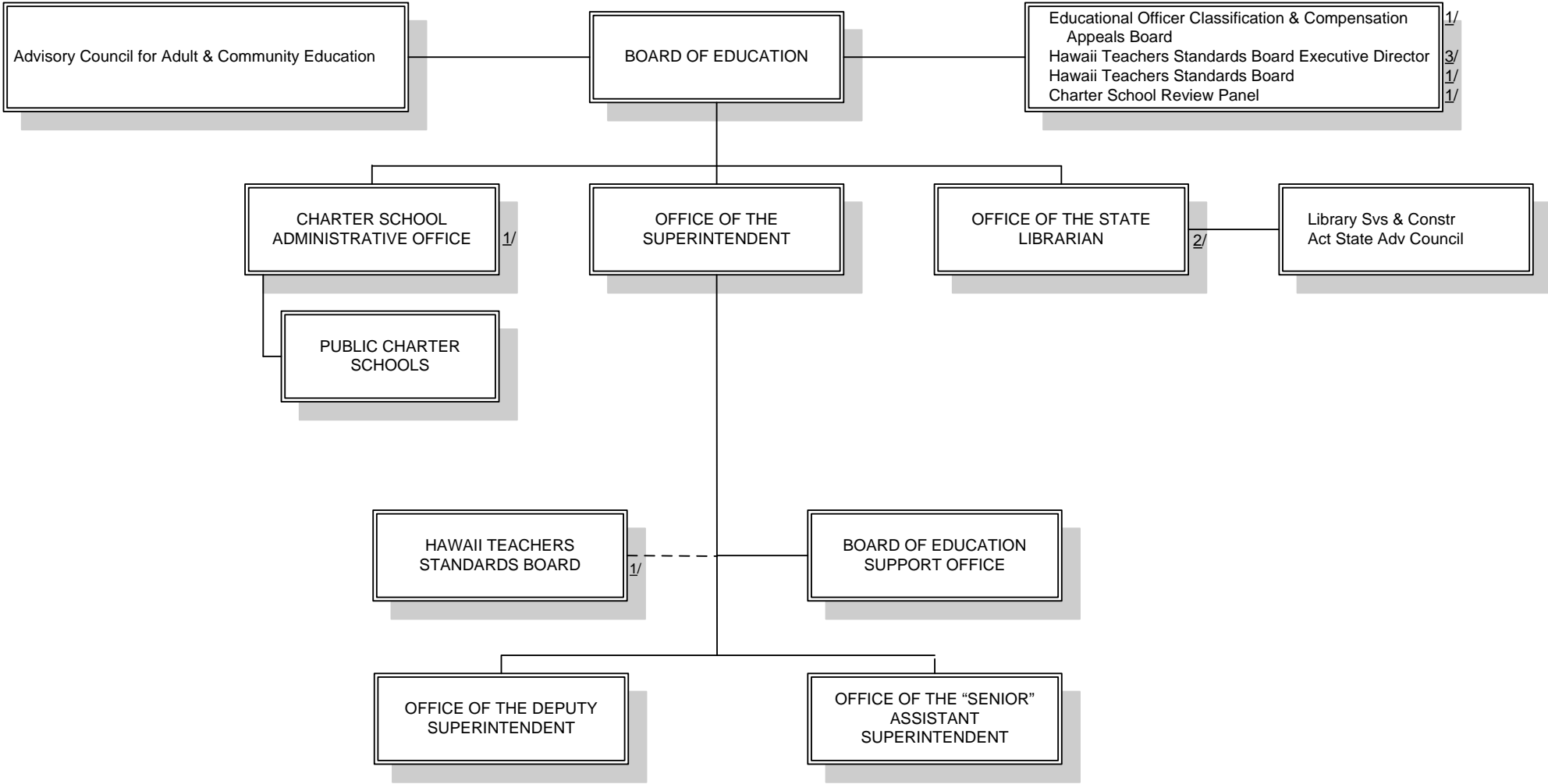

1/ Attached to DOE for administrative purposes only in accordance with law.
 2/ The public library system organization is published separately by the State Librarian.
 3/ The Executive Director of the Hawaii Teachers Standards Board is appointed by the BOE.

COMPLEX AREA SCHOOLS

HONOLULU DISTRICT

Farrington/Kaiser/Kalani Complex Area

Farrington Complex

Farrington High
Dole Middle
Kalakaua Middle
Fern Elementary
Kaewai Elementary
Kalihi Elementary
Kalihi-kai Elementary
Kalihi-uka Elementary
Kalihi-waena Elementary
Kapalama Elementary
Linapuni Elementary
Puuhale Elementary

Kaiser Complex

Kaiser High
Niu Valley Middle
Aina Haina Elementary
Hahaione Elementary
Kamiloiki Elementary
Koko Head Elementary

Kalani Complex

Kalani High
Kaimuki Middle
Kahala Elementary
Liholiho Elementary
Waikiki Elementary
Wilson Elementary
Hawaii School for the Deaf & the Blind

Community School for Adults

Farrington Community School

Kaimuki/McKinley/Roosevelt Complex Area

Kaimuki Complex

Kaimuki High
Jarrett Middle
Washington Middle
Ala Wai Elementary
Aliiolani Elementary
Hokulani Elementary
Jefferson Elementary
Kuhio Elementary
Lunalilo Elementary
Palolo Elementary

McKinley Complex

McKinley High
Central Middle
Kaahumanu Elementary
Kaiulani Elementary
Kauluwela Elementary
Lanakila Elementary
Likelike Elementary
Royal Elementary

Roosevelt Complex

Roosevelt High
Kawananakoa Middle
Stevenson Middle
Lincoln Elementary
Maemae Elementary
Manoa Elementary
Noelani Elementary
Nuuanu Elementary
Pauoa Elementary
Anuenue Elementary & High

Community School for Adults

Kaimuki Community School

Community School for Adults

McKinley Community School

CENTRAL DISTRICT

Aiea/Moanalua Radford Complex Area

Aiea Complex

Aiea High
Aiea Intermediate
Aiea Elementary
Pearl Ridge Elementary
Scott Elementary
Waimalu Elementary
Webbing Elementary

Moanalua Complex

Moanalua High
Moanalua Middle
Moanalua Elementary
Red Hill Elementary
Salt Lake Elementary
Shafter Elementary

Radford Complex

Radford High
Aliamanu Middle
Aliamanu Elementary
Hickam Elementary
Makalapa Elementary
Mokulele Elementary
Nimitz Elementary
Pearl Harbor Elementary
Pearl Harbor Kai Elementary

Community School for Adults

Moanalua/Aiea Community School

Leilehua/Mililani/Waialua Complex Area

Leilehua Complex

Leilehua High
Wahiawa Middle
Wheeler Middle
Hale Kula Elementary
Helemano Elementary
Iliahi Elementary
Kaala Elementary
Solomon Elementary
Wahiawa Elementary
Wheeler Elementary

Mililani Complex

Mililani High
Mililani Middle
Kipapa Elementary
Mililani 'Ike Elementary
Mililani Mauka Elementary
Mililani Uka Elementary
Mililani Waena Elementary

Waialua Complex

Waialua High & Intermediate
Haleiwa Elementary
Waialua Elementary

Community School for Adults

Wahiawa Community School

COMPLEX AREA SCHOOLS

LEEWARD DISTRICT

Campbell/Kapolei Complex Area

Campbell Complex

Campbell High
Ilima Intermediate
Ewa Elementary
Ewa Beach Elementary
Ewa Makai Middle
Holomua Elementary
Iroquois Point Elementary
Kaimiloa Elementary
Keoneula Elementary
Pohakea Elementary

Kapolei Complex

Kapolei High
Kapolei Middle
Barbers Point Elementary
Kapolei Elementary
Makakilo Elementary
Mauka Lani Elementary

Waianae/Nanakuli Complex Area

Waianae Complex

Waianae High
Waianae Intermediate
Leihoku Elementary
Maili Elementary
Makaha Elementary
Waianae Elementary

Nanakuli Complex

Nanakuli High & Intermediate
Nanaikapono Elementary
Nanakuli Elementary

Pearl City/Waipahu Complex Area

Pearl City Complex

Pearl City High
Highlands Intermediate
Kanoelani Elementary
Lehua Elementary
Manana Elementary
Momilani Elementary
Palisades Elementary
Pearl City Elementary
Pearl City Highlands Elementary
Waiau Elementary

Waipahu Complex

Waipahu High
Waipahu Intermediate
August Ahrens Elementary
Honowai Elementary
Kaleiopuu Elementary
Waikele Elementary
Waipahu Elementary

Community School for Adults

Waipahu Community School

WINDWARD DISTRICT

Castle/Kahuku Complex Area

Castle Complex

Castle High
King Intermediate
Ahuimanu Elementary
Heeia Elementary
Kahaluu Elementary
Kapunahala Elementary
Parker Elementary
Puohala Elementary
Waiahole Elementary

Kahuku Complex

Kahuku High & Intermediate
Hauula Elementary
Kaaawa Elementary
Kahuku Elementary
Laie Elementary
Sunset Beach Elementary

Kailua/Kalaheo Complex Area

Kailua Complex

Kailua High
Enchanted Lake Elementary
Kaelepulu Elementary
Keolu Elementary
Maunawili Elementary
Pope Elementary
Waimanalo Elem & Intermediate
Olomana School

Kalaheo Complex

Kalaheo High
Kailua Intermediate
Aikahi Elementary
Kailua Elementary
Kainalu Elementary
Mokapu Elementary

Community School for Adults

Windward School for Adults

COMPLEX AREA SCHOOLS

HAWAII DISTRICT

Hilo/Laupahoehoe/Waiakea Complex Area

Hilo Complex

Hilo High
Hilo Intermediate
Kalaniana'ole Elem & Intermediate
DeSilva Elementary
Haaheo Elementary
Hilo Union Elementary
Kapiolani Elementary
Kaumana Elementary
Keaukaha Elementary

Laupahoehoe Complex

Laupahoehoe High & Elementary

Waiakea Complex

Waiakea High
Waiakea Intermediate
Waiakea Elementary
Waiakeawaena Elementary

Community School for Adults

Hilo Community School

Ka'u/Keaau/Pahoa Complex Area

Ka'u Complex

Ka'u High & Pahala Elementary
Naalehu Elementary

Keaau Complex

Keaau High
Keaau Middle
Keaau Elementary
Mountain View Elementary

Pahoa Complex

Pahoa High & Intermediate
Keonepoko Elementary
Pahoa Elementary

Honokaa/Kealakehe/Kohala/Konawaena Complex Area

Honokaa Complex

Honokaa High & Intermediate
Paauiolo Elementary & Intermediate
Honokaa Elementary
Waimea Elementary

Kealakehe Complex

Kealakehe High
Kealakehe Intermediate
Holualoa Elementary
Kahakai Elementary
Kealakehe Elementary
Waikoloa Elementary & Middle

Kohala Complex

Kohala High
Kohala Middle
Kohala Elementary

Konawaena Complex

Konawaena High
Konawaena Middle
Konawaena Elementary
Honaunau Elementary
Hookena Elementary
Ke Kula O Ehunuikaimalino High & El

Community School for Adults

Kona Community School

MAUI DISTRICT

Baldwin/Kekaulike/Maui Complex Area

Baldwin Complex

Baldwin High
Iao Intermediate
Waihee Elementary
Wailuku Elementary

Kekaulike Complex

Kekaulike High
Kalama Intermediate
Haiku Elementary
Kula Elementary
Makawao Elementary
Paia Elementary
Pukalani Elementary

Maui Complex

Maui High
Lokelani Intermediate
Maui Waena Intermediate
Kahului Elementary
Kamalii Elementary
Kihei Elementary
Lihikai Elementary
Pomaikai Elementary

Community School for Adults

Maui Community School

Hana/Lahaina/Lanai/Molokai Complex Area

Hana Complex

Hana High & Elementary

Lahaina Complex

Lahainaluna High
Lahaina Intermediate
Kamehameha III Elementary
Nahienaena Elementary

Lanai Complex

Lanai High & Elementary

Molokai Complex

Molokai High
Molokai Middle
Kaunakakai Elementary
Kilohana Elementary
Maunaloa Elementary

COMPLEX AREA SCHOOLS

KAUAI DISTRICT

Kapaa/Kauai/Waimea Complex Area

Kapaa Complex

Kapaa High
Kapaa Middle
Hanalei Elementary
Kapaa Elementary
Kilauea Elementary

Kauai Complex

Kauai High
Kamakahahei Middle
Kaumualii Elementary
Koloa Elementary
Wilcox Elementary

Waimea Complex

Waimea High
Waimea Canyon Middle
Eleele Elementary
Kalaheo Elementary
Kekaha Elementary
Niihau High & Elementary

Community School for Adults

Kauai Community School

PUBLIC CHARTER SCHOOLS
Act 298, Session Laws of Hawaii 2006

“SECTION 1. The charter school system is an important complement to the department of education’s school system, one that empowers local school boards and their charter schools by allowing more autonomy and flexibility and placing greater responsibility at the school level. The charter school system is made up of the board of education, the charter school administrative office, the charter school review panel, and individual charter schools with differing visions, missions, and approaches to meeting the various needs and desires of Hawaii’s communities.

The purposes of the charter school system include: 1) providing administrators, parents, students, and teachers with expanded alternative public school choices in the types of schools, educational programs, opportunities, and settings, including services for underserved populations, geographical areas, and communities; and 2) encouraging and, when resources and support are provided, serving as a research venue for the development, use, and dissemination of alternative and innovate approaches to educational governance, financing, administration, curricula, technology, and teaching strategies.

The purpose of the Act is to improve Hawaii’s charter school system by adopting many of the priority proposals developed by the task force on charter school governance established by Act 87, SLH 2005.”

Charter School Administrative Office

Pursuant to Section 302B-8, Hawaii Revised Statutes, there is established a Charter School Administrative Office headed by an Executive Director appointed by the Charter School Review Panel based upon the recommendations of an organization of charter schools operating within the State or from a list of nominees submitted by the charter schools. The Charter School Administrative Office is attached to the Department of Education for administrative purposes only. The Executive Director is responsible for the internal organization, operation, and management of the charter school system, including:

- 1) preparing and executing the budget for the charter schools, including submission of the budget request to the Board, Governor, and the Legislature;
- 2) allocating annual appropriations to the charter schools and distributing federal funds to charter schools;
- 3) complying with applicable state laws related to the administration of the charter schools;
- 4) preparing contracts between the charter schools and the Department of Education for centralized services to be provided by the department;
- 5) preparing contracts between the charter schools and other state agencies for financial or personnel services to be provided by the agencies to the charter schools;
- 6) providing independent analysis and recommendations on charter school issues;
- 7) representing charter schools and the charter school system in communications with the Board, the Governor, and the Legislature;
- 8) providing advocacy, assistance, and support for the development, growth, progress, and success of charter schools and the charter school system;
- 9) providing guidance and assistance to charter applicants

and charter schools to enhance the completeness and accuracy of information for panel review; 10) assisting charter applicants and charter schools in coordinating their interactions with the Panel as needed; 11) assisting the Panel to coordinate with charter schools in panel investigations and evaluations of charter schools; 12) serving as the conduit to disseminate communications from the Panel, Board, and the Department to all charter schools; 13) determining the charter school system needs and communicating those needs to the Panel, the Board, and the Department; 14) establishing a dispute resolution and mediation process; and 15) upon request by one or more charter schools, assisting in the negotiation of a collective bargaining agreement with the exclusive representative of its employees.

Public Charter Schools

Honolulu District

Education Laboratory (K-12)
Halau Ku Mana (6-12)
Halau Lokahi (K-12)
Myron B. Thompson Academy (K-12)
Voyager (K-8)
Waialae Elementary (K-5)

Leeward District

Hawaii Technology Academy (K-12)
Ka Waihona 'o ka Na'auao (K-8)
Kamaile Academy (K-9)

Windward District

Hakipu'u Learning Center (4-12)
Ke Kula 'o Samuel M. Kamakau Laboratory (K-12)
Lanikai Elementary (JK-6)

Hawaii District

Connections (K-12)
Hawaii Academy of Arts and Science (K-12)
Innovations (1-8)
Ka 'Umeke Ka'eo (K-10)
Ke Ana La'ahana (7-12)
Ke Kula 'o Nawahiokalani'opu'u Iki Laboratory (K-8)
Kona Pacific (K-7)
Kanu 'o ka 'Aina (JK-12)
Kua 'o Ka La (K-3; 6-12)
Volcano School of Arts and Sciences (K-8)
Waters of Life (K-7)
Waimea Middle (6-8)
West Hawaii Explorations Academy (6-12)

Maui District

Kihei (K-12)
Kualapu'u Elementary (PK-6)

Kauai District

Kanuikapono (K-12)
Kawaikini (K-12)
Ke Kula Ni'ihau O Kekaha Learning Center (K-12)
Kula Aupuni Ni'ihau A Kahelelani Aloha (K-12)

STATE OF HAWAII
DEPARTMENT OF EDUCATION
BOARD OF EDUCATION
POSITION ORGANIZATION CHART

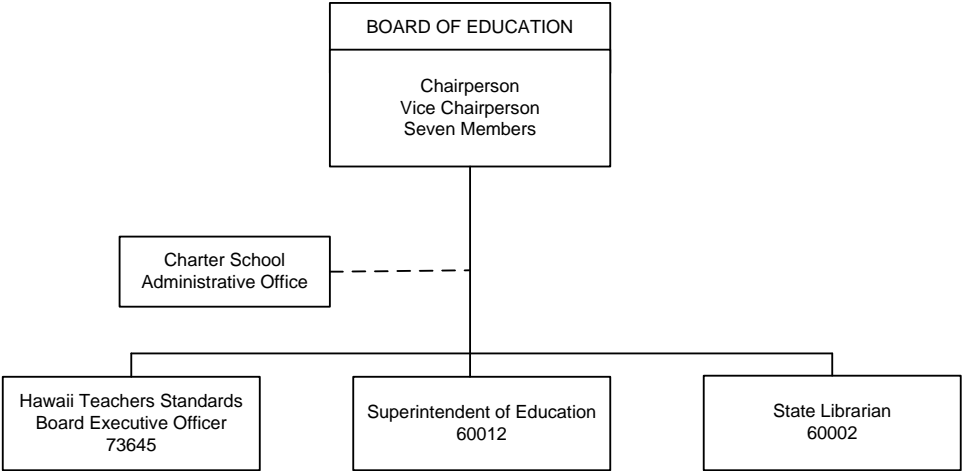

Department of Education
Organizational Chart

Table 24

STATE OF HAWAII
DEPARTMENT OF EDUCATION
OFFICE OF THE SUPERINTENDENT
ORGANIZATION CHART

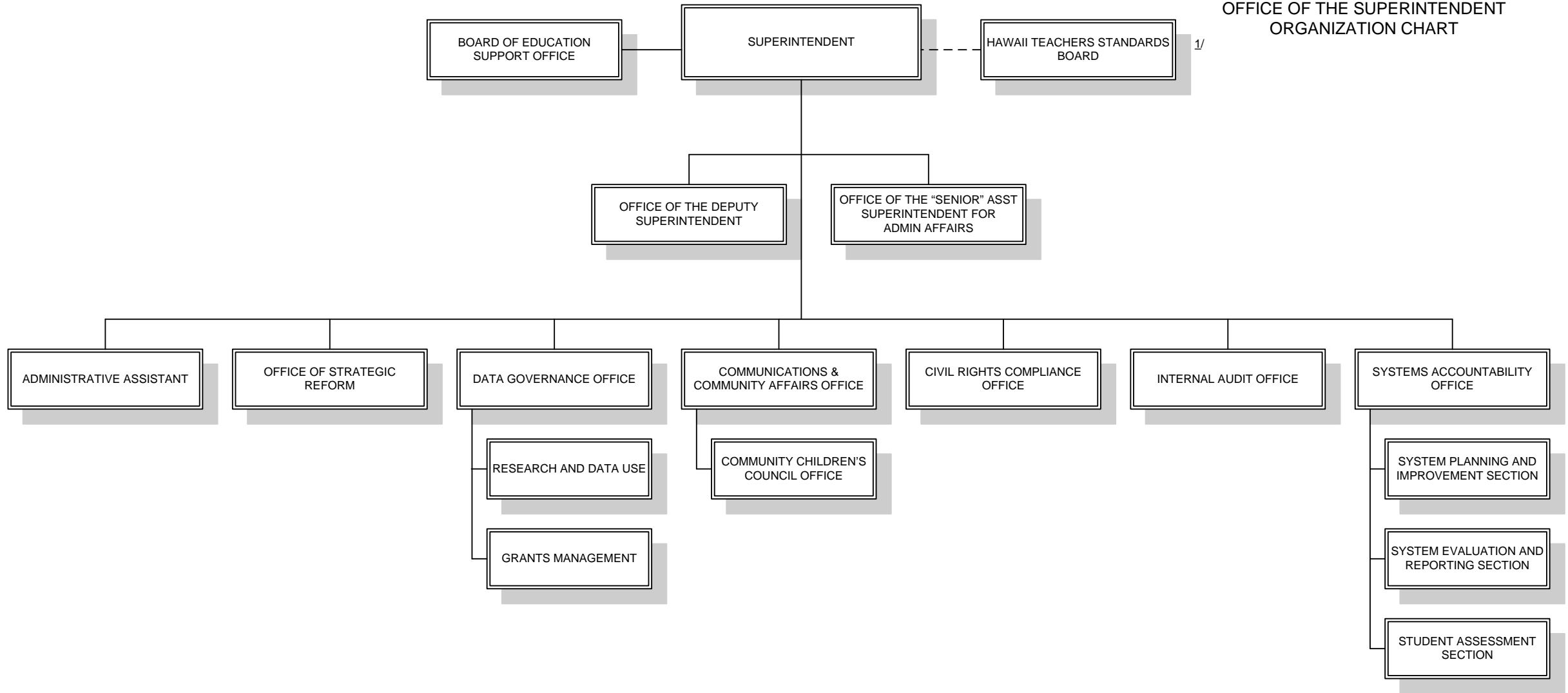

^{1/} Attached to the DOE for administrative purposes only

Department of Education
Organizational Chart

Table 24

STATE OF HAWAII
DEPARTMENT OF EDUCATION
OFFICE OF THE SUPERINTENDENT
POSITION ORGANIZATION CHART

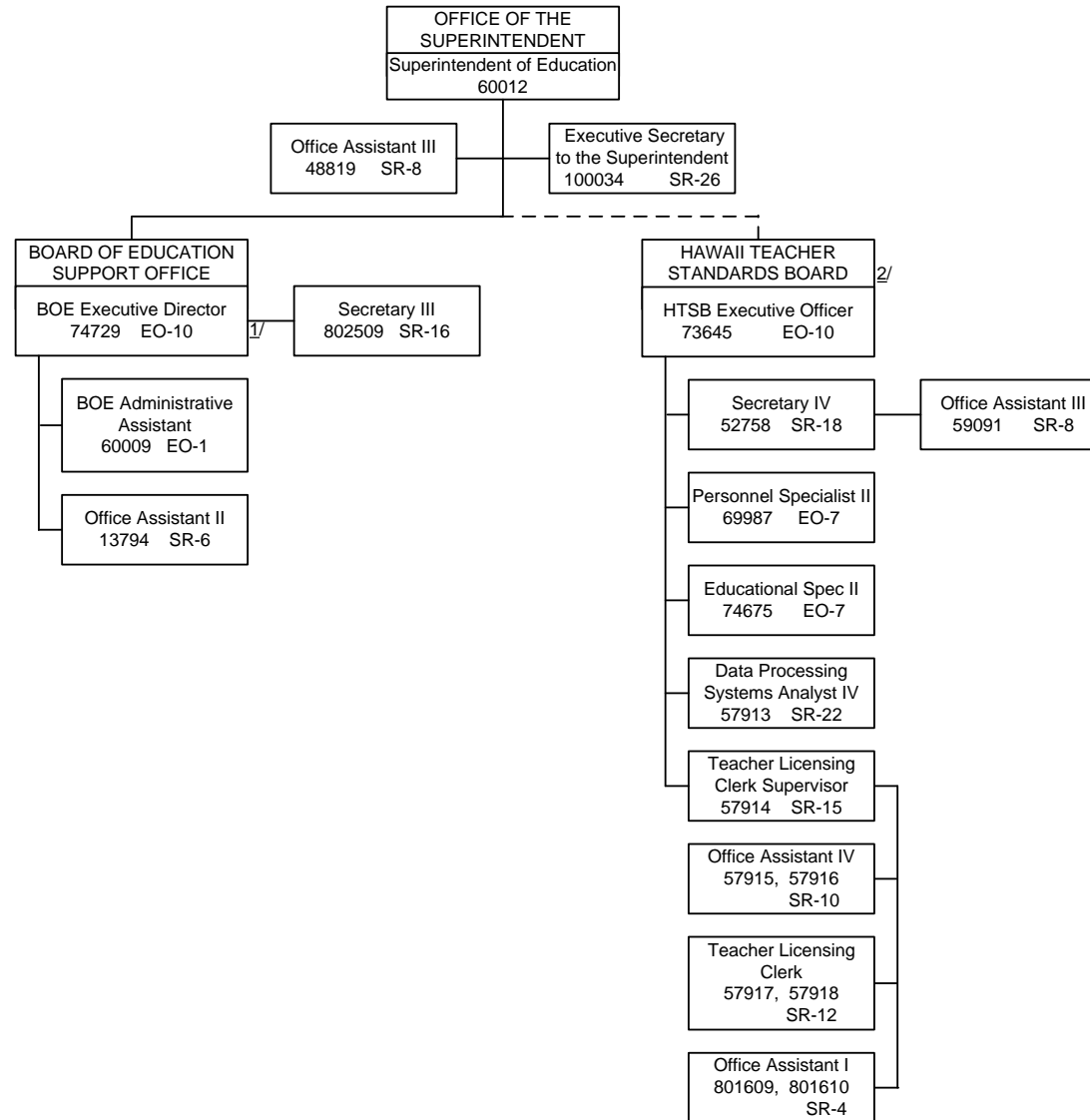

1/ Temporary position, General funds
2/ Attached to the DOE for administrative purposes only

Department of Education
Organizational Chart

Table 24

STATE OF HAWAII
DEPARTMENT OF EDUCATION
OFFICE OF THE SUPERINTENDENT
POSITION ORGANIZATION CHART

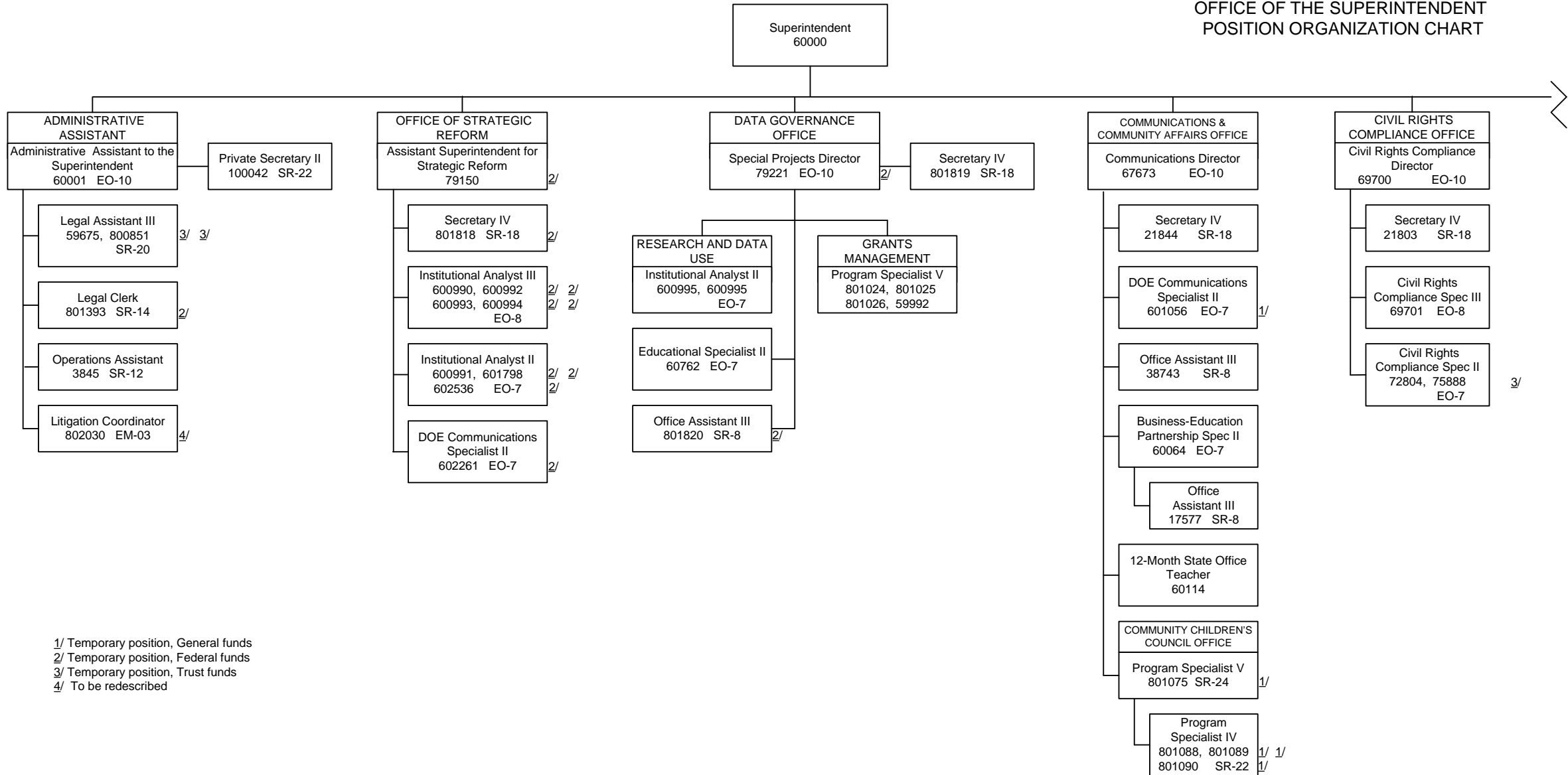

1/ Temporary position, General funds
2/ Temporary position, Federal funds
3/ Temporary position, Trust funds
4/ To be redescribed

STATE OF HAWAII
DEPARTMENT OF EDUCATION
OFFICE OF THE SUPERINTENDENT
POSITION ORGANIZATION CHART

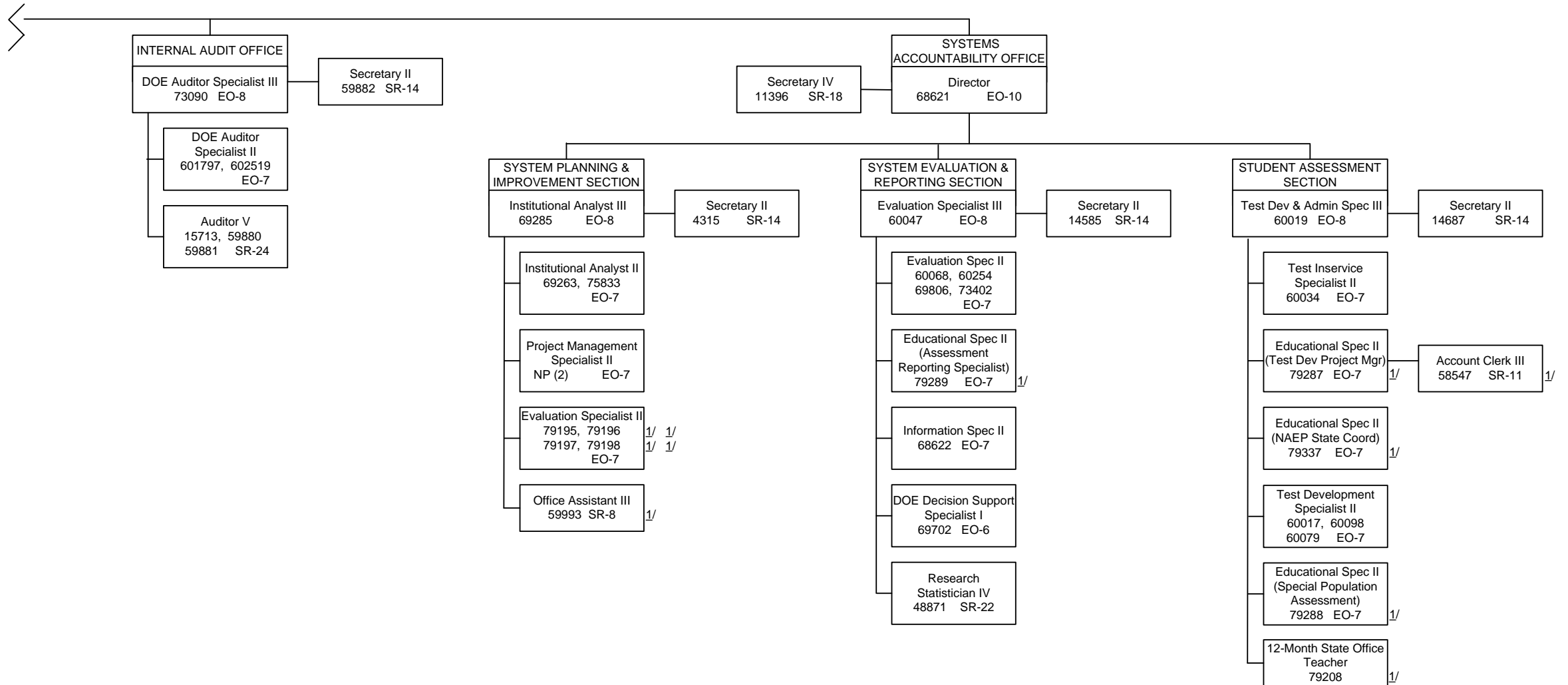

1/ Temporary position, Federal funds

STATE OF HAWAII
DEPARTMENT OF EDUCATION
OFFICE OF THE DEPUTY SUPERINTENDENT
ORGANIZATION CHART

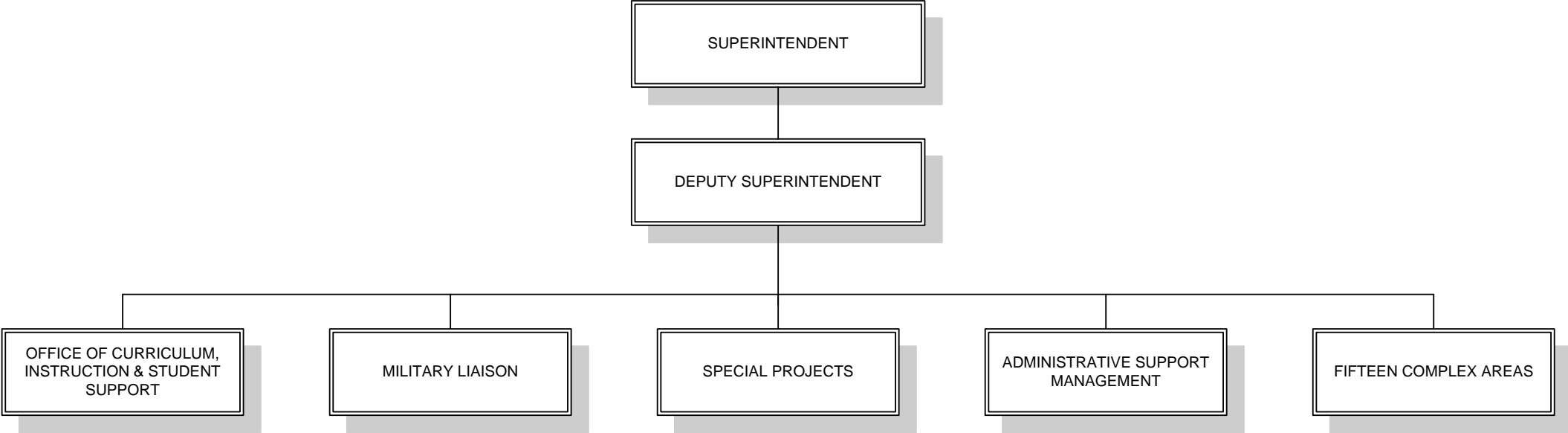

STATE OF HAWAII
DEPARTMENT OF EDUCATION
OFFICE OF THE DEPUTY SUPERINTENDENT
POSITION ORGANIZATION CHART

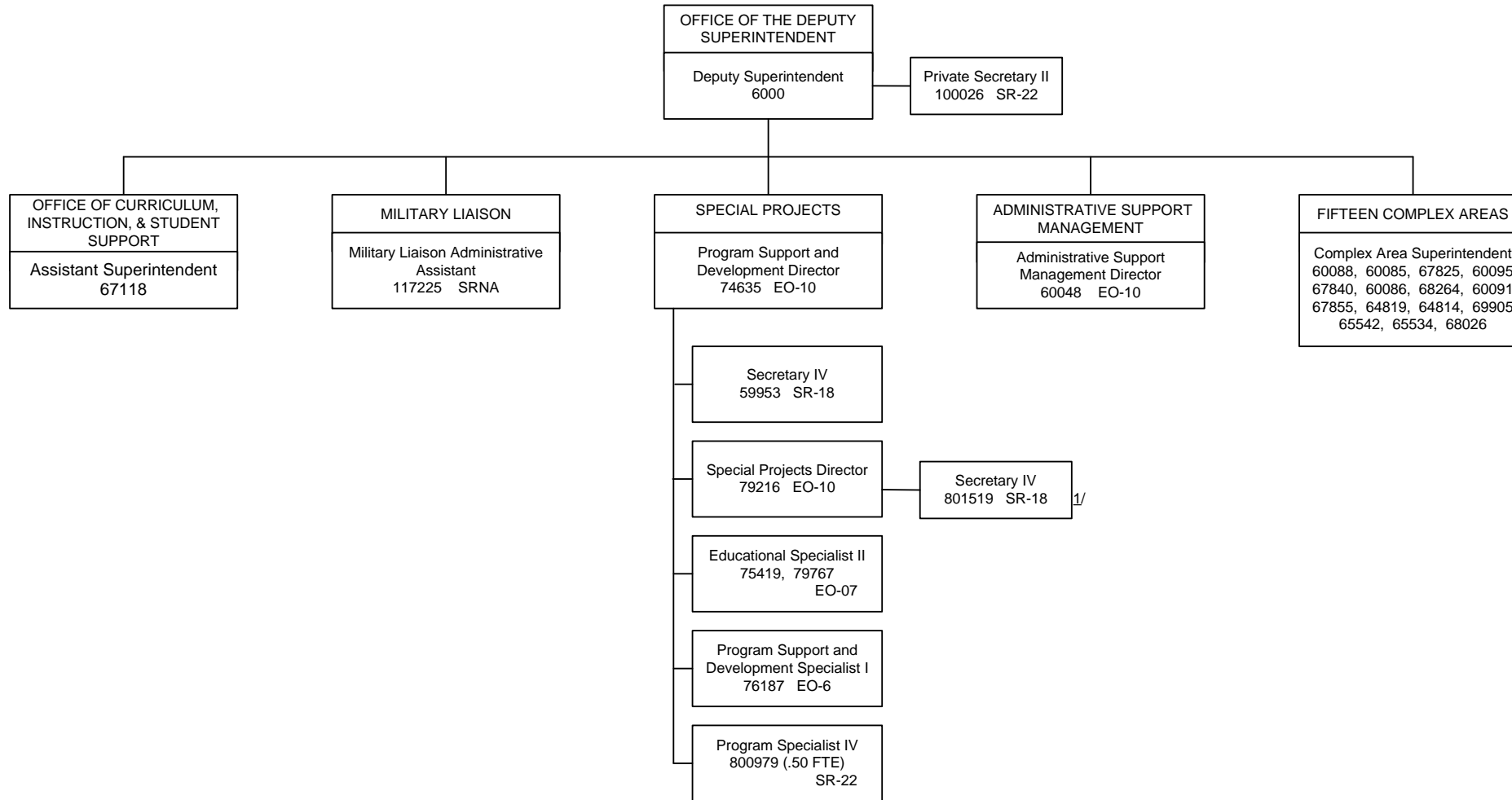

1/ Temporary position, Federal funds

STATE OF HAWAII
DEPARTMENT OF EDUCATION
OFFICE OF THE DEPUTY SUPERINTENDENT
OFFICE OF CURRICULUM, INSTRUCTION, AND STUDENT SUPPORT
ORGANIZATION CHART

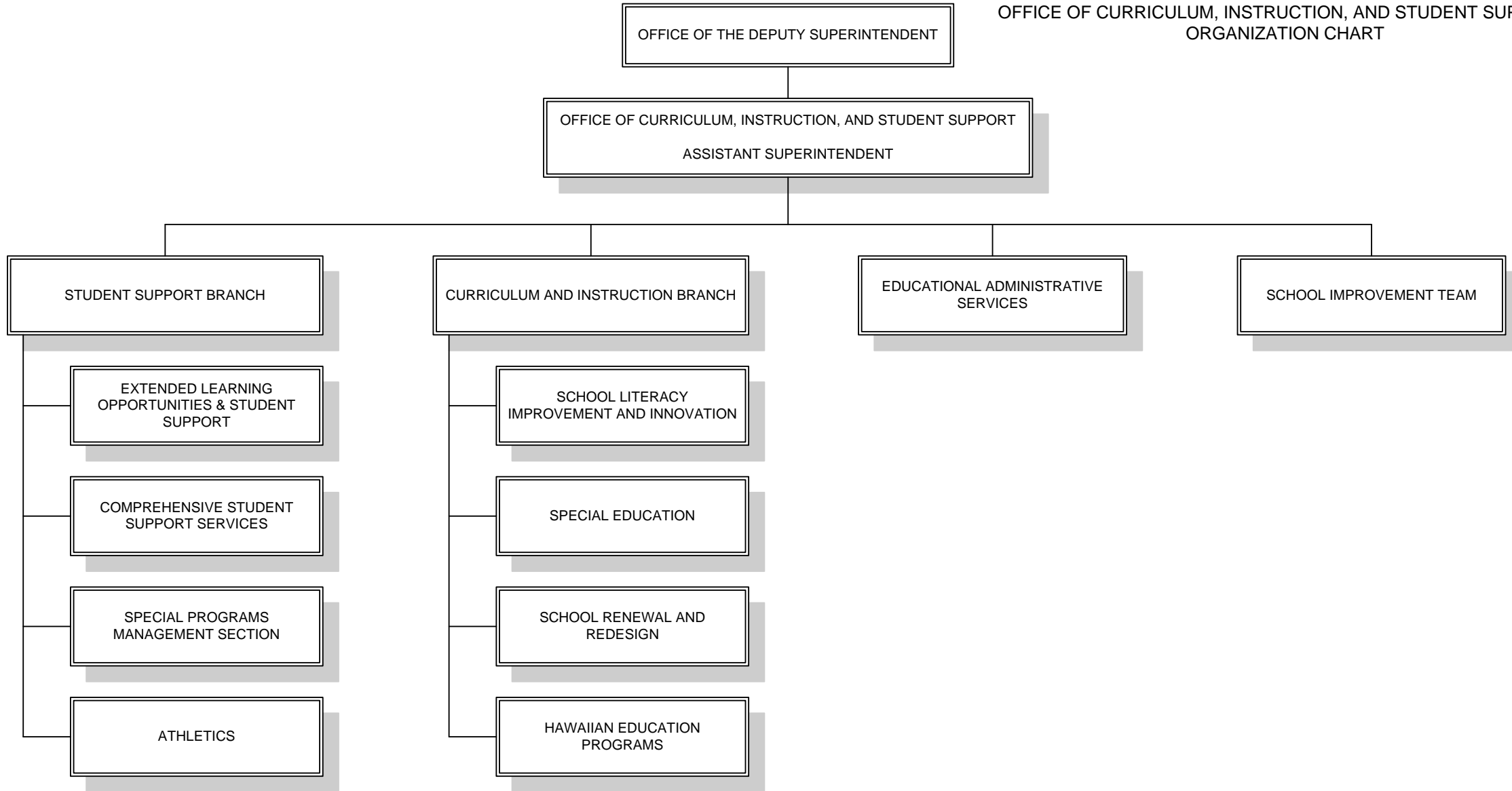

Department of Education
Organizational Chart

Table 24

STATE OF HAWAII
DEPARTMENT OF EDUCATION
OFFICE OF THE DEPUTY SUPERINTENDENT
OFFICE OF CURRICULUM, INSTRUCTION, AND STUDENT SUPPORT
POSITION ORGANIZATION CHART

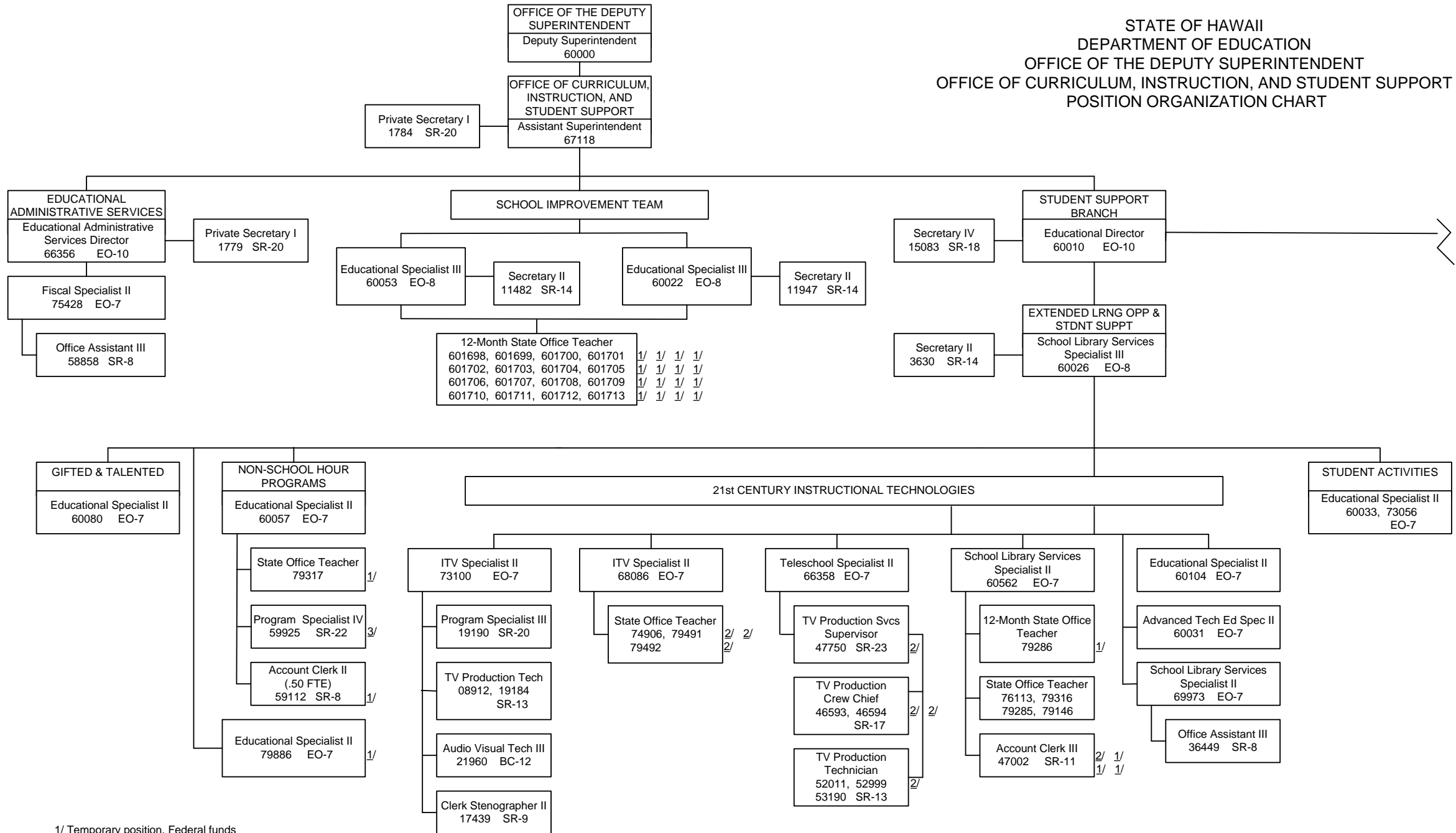

1/ Temporary position, Federal funds
2/ Temporary position, Trust funds
3/ Temporary position, Revolving funds

STATE OF HAWAII
DEPARTMENT OF EDUCATION
OFFICE OF THE DEPUTY SUPERINTENDENT
OFFICE OF CURRICULUM, INSTRUCTION, AND STUDENT SUPPORT
POSITION ORGANIZATION CHART

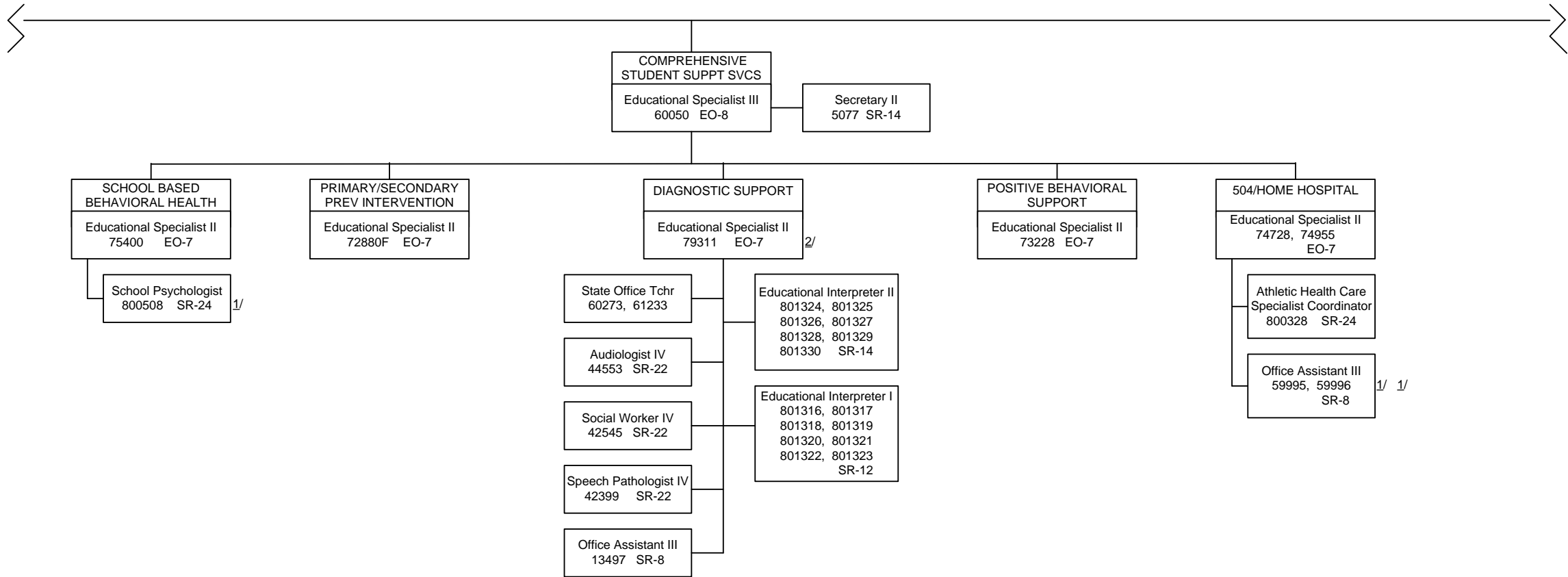

1/ Temporary position, General funds
2/ Temporary position, Federal funds

STATE OF HAWAII
DEPARTMENT OF EDUCATION
OFFICE OF THE DEPUTY SUPERINTENDENT
OFFICE OF CURRICULUM, INSTRUCTION, AND STUDENT SUPPORT
POSITION ORGANIZATION CHART

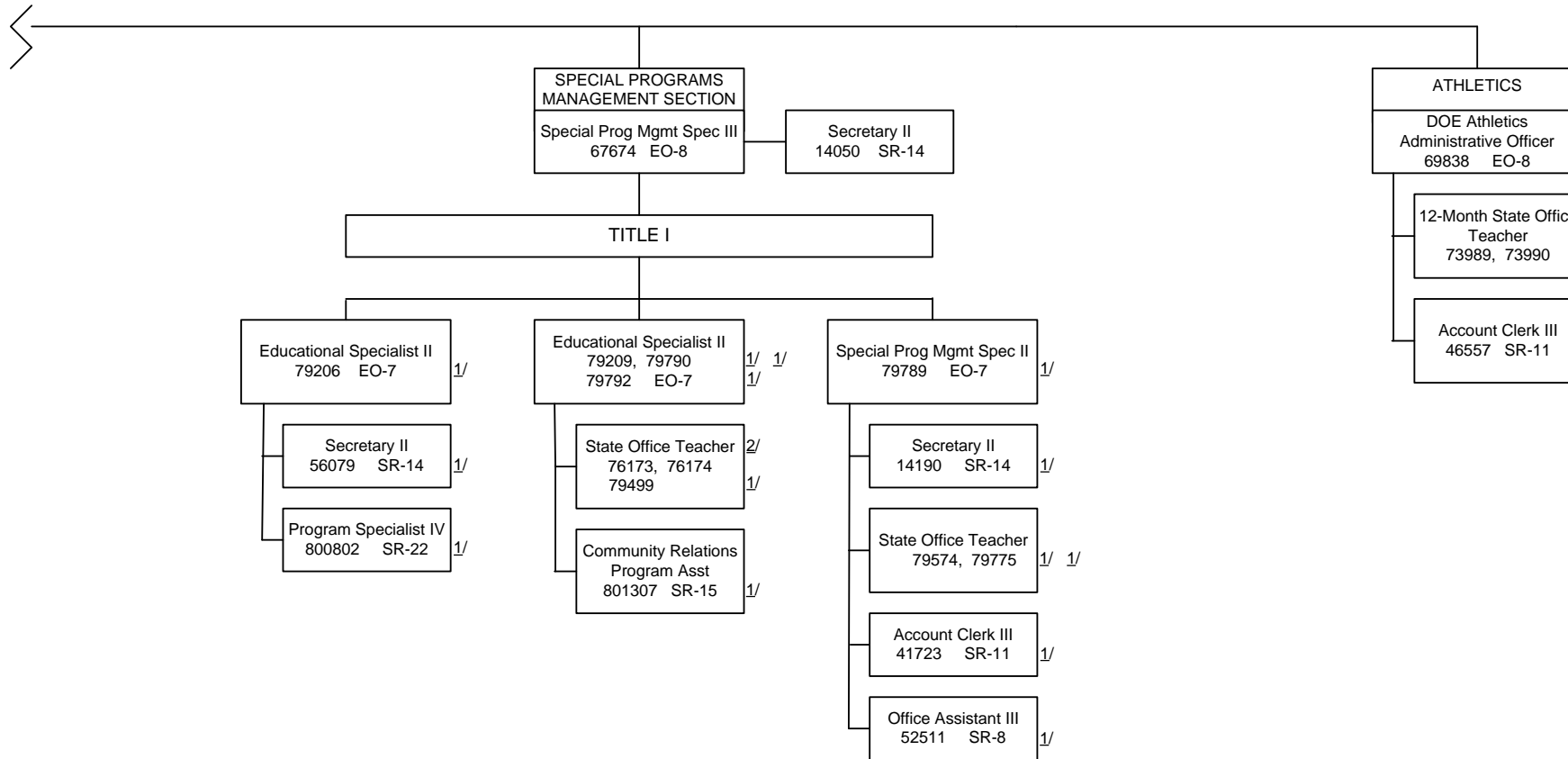

1/ Temporary position, Federal funds

2/ State Office Teacher position nos. 76143, 76174 & 79499 receive technical supervision from Educational Specialist II, position no. 79209

Department of Education
Organizational Chart

Table 24

STATE OF HAWAII
DEPARTMENT OF EDUCATION
OFFICE OF THE DEPUTY SUPERINTENDENT
OFFICE OF CURRICULUM, INSTRUCTION, AND STUDENT SUPPORT
POSITION ORGANIZATION CHART

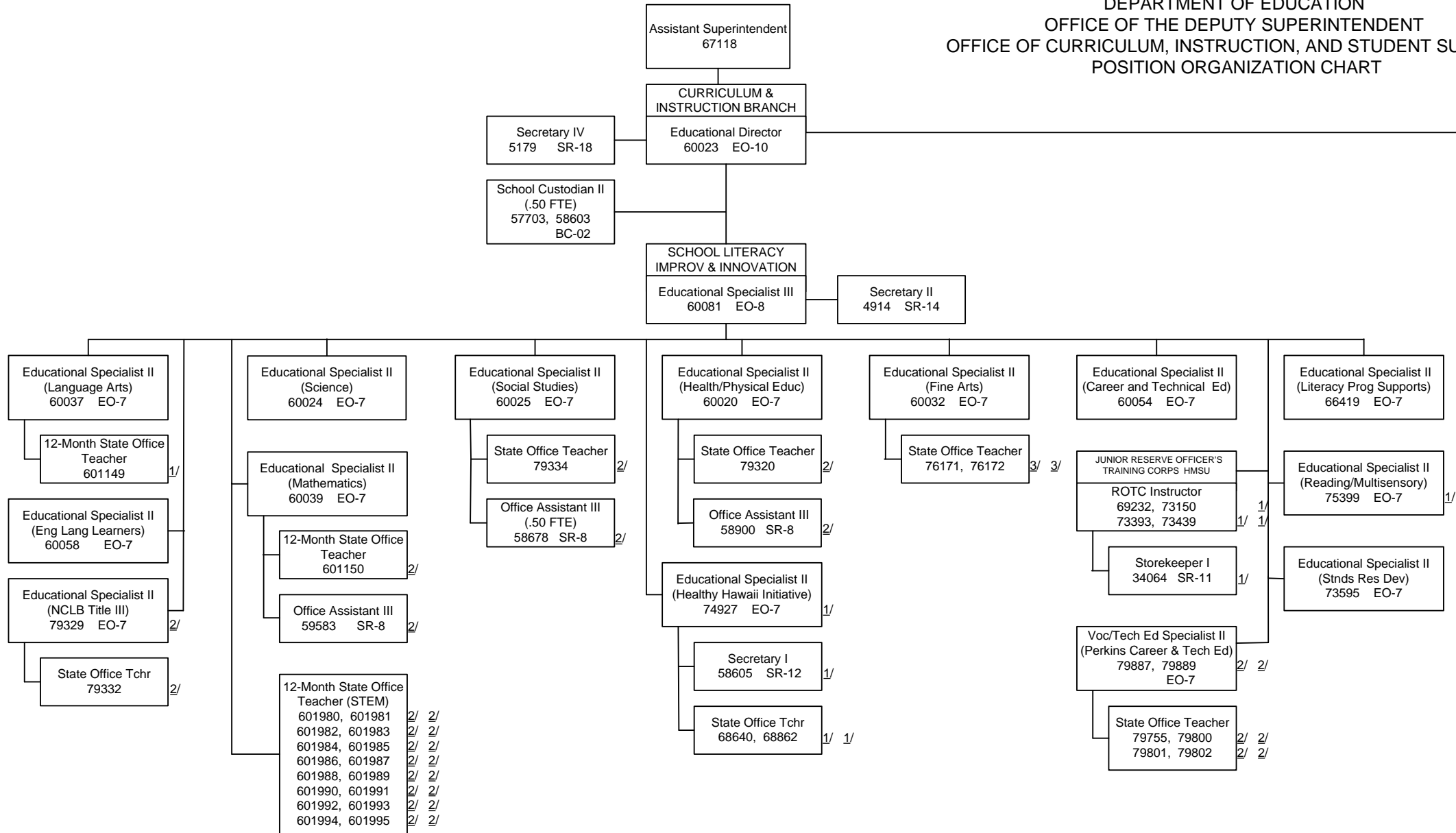

1/ Temporary position, General funds
2/ Temporary position, Federal funds
3/ Temporary position, Special funds

E-5

6/30/12

2014 Budget Briefing

STATE OF HAWAII
DEPARTMENT OF EDUCATION
OFFICE OF THE DEPUTY SUPERINTENDENT
OFFICE OF CURRICULUM, INSTRUCTION, AND STUDENT SUPPORT
POSITION ORGANIZATION CHART

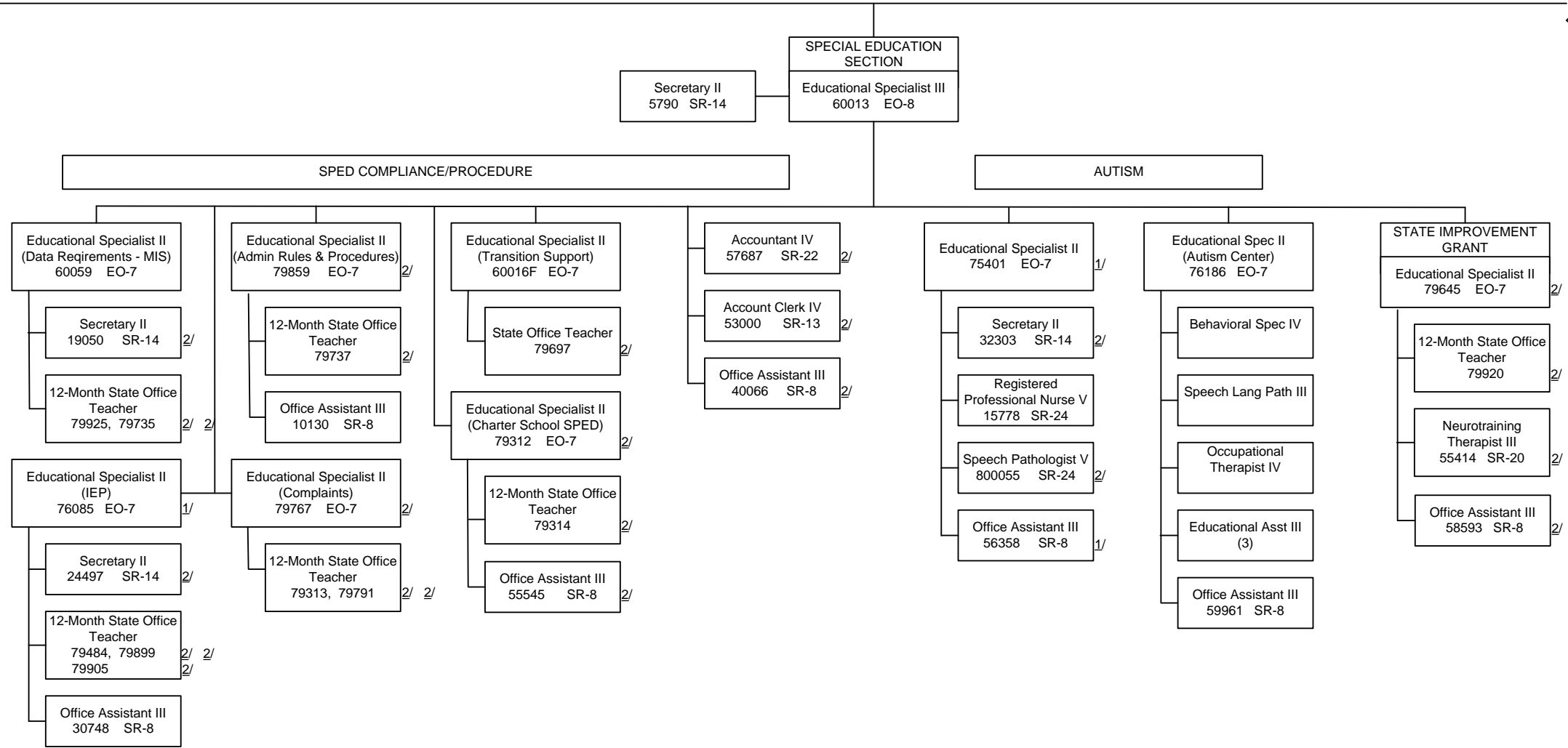

1/ Temporary position, General funds
2/ Temporary position, Federal funds

STATE OF HAWAII
DEPARTMENT OF EDUCATION
OFFICE OF THE DEPUTY SUPERINTENDENT
OFFICE OF CURRICULUM, INSTRUCTION, AND STUDENT SUPPORT
POSITION ORGANIZATION CHART

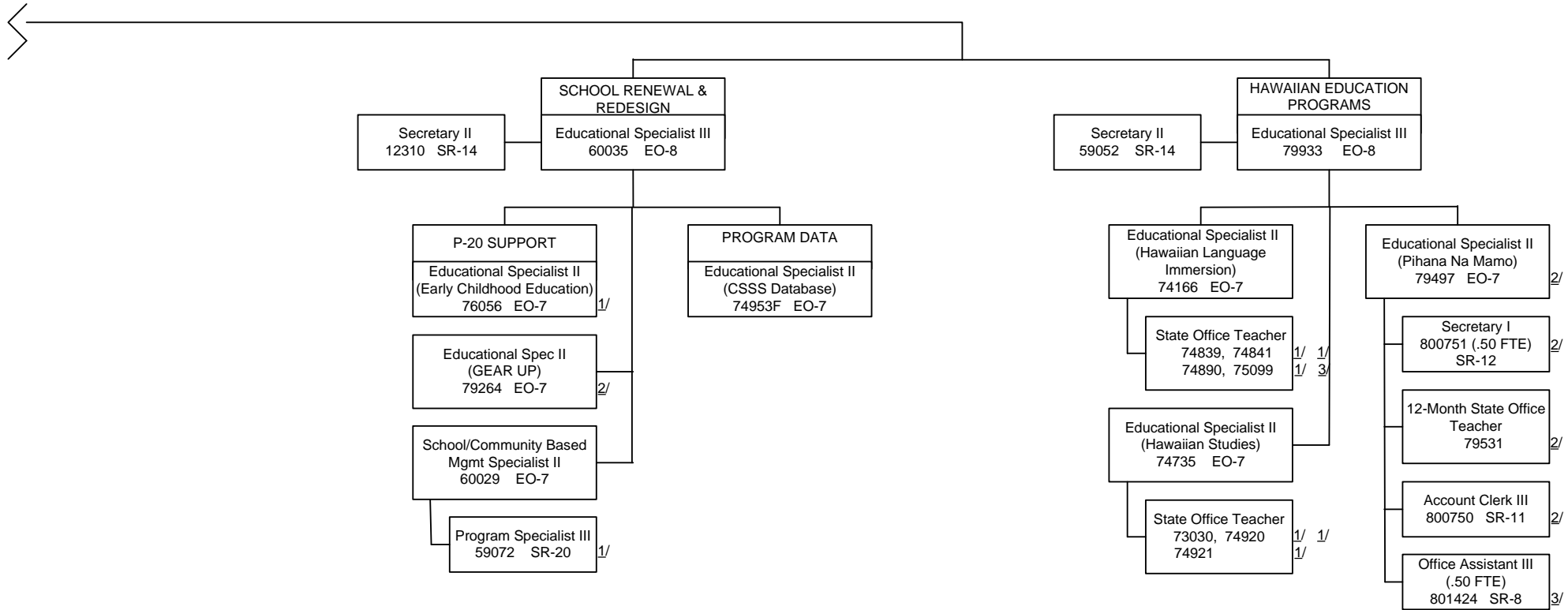

1/ Temporary position, General funds
2/ Temporary position, Federal funds
3/ Temporary position, Trust funds

Department of Education
Organizational Chart

Table 24

STATE OF HAWAII
DEPARTMENT OF EDUCATION
OFFICE OF THE DEPUTY SUPERINTENDENT
COMPLEX AREA SUPERINTENDENTS
POSITION ORGANIZATION CHART

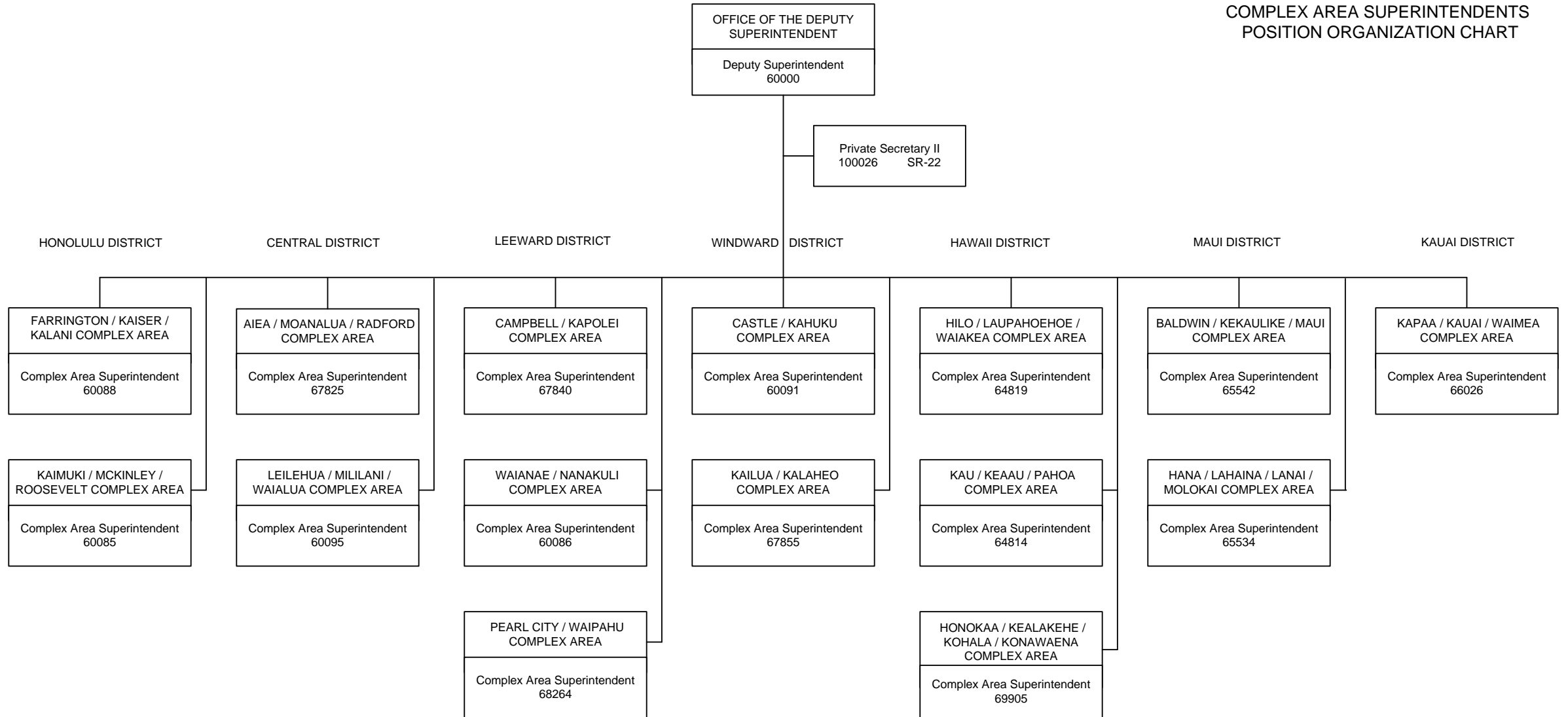

STATE OF HAWAII
DEPARTMENT OF EDUCATION
OFFICE OF THE DEPUTY SUPERINTENDENT
HONOLULU DISTRICT
ORGANIZATION CHART

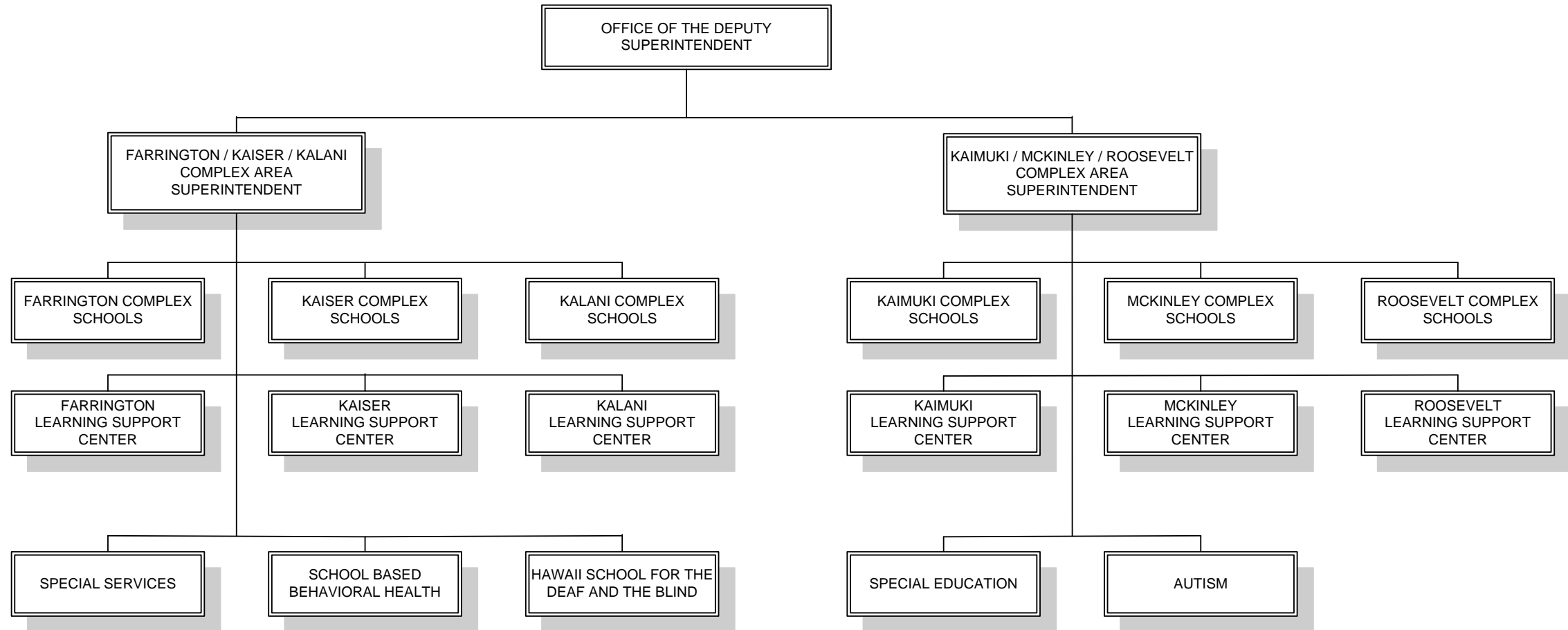

STATE OF HAWAII
DEPARTMENT OF EDUCATION
OFFICE OF THE DEPUTY SUPERINTENDENT
HONOLULU DISTRICT
POSITION ORGANIZATION CHART

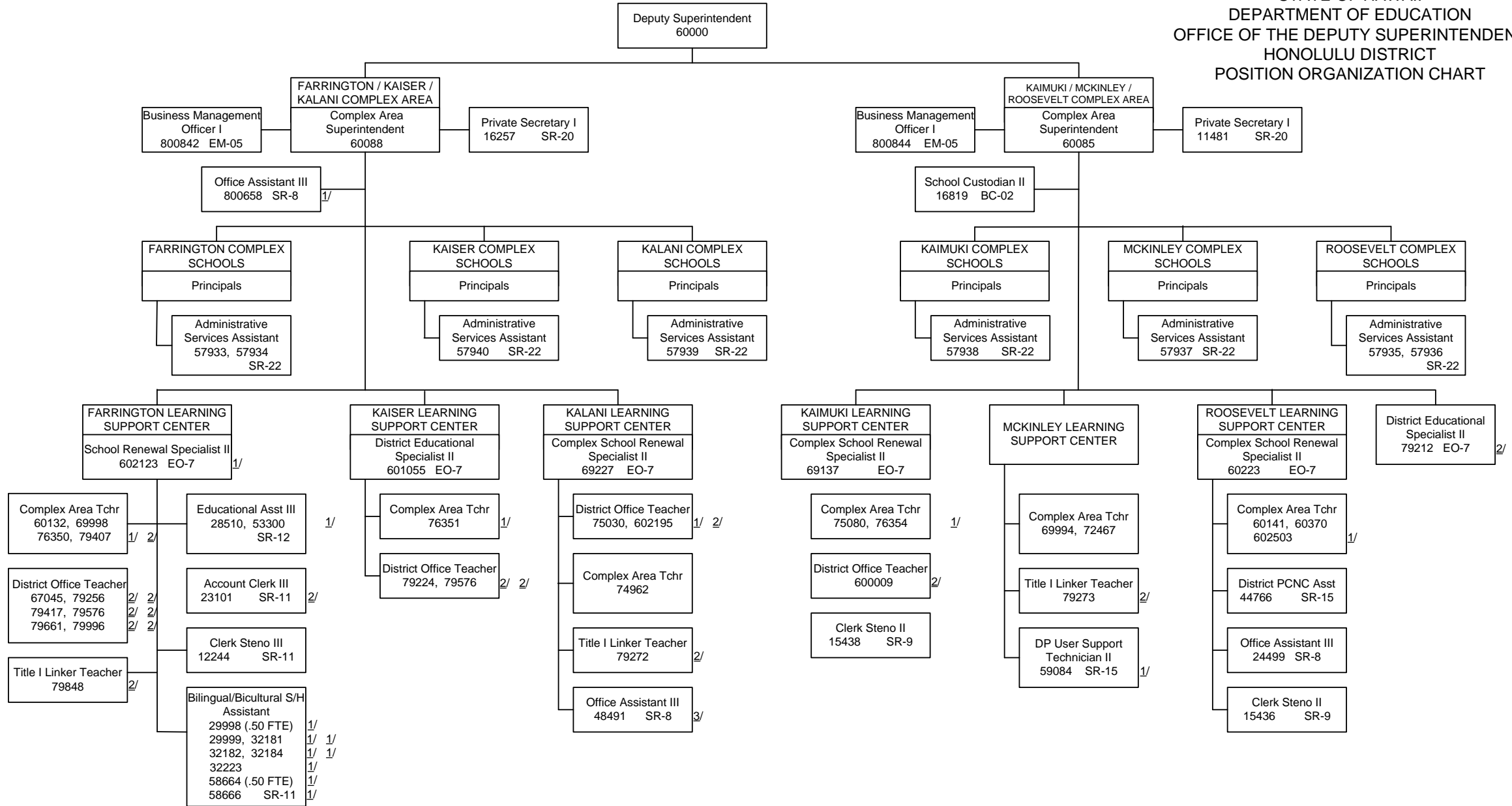

1/ Temporary position, General funds
2/ Temporary position, Federal funds
3/ Temporary position, Revolving funds

STATE OF HAWAII
DEPARTMENT OF EDUCATION
OFFICE OF THE DEPUTY SUPERINTENDENT
HONOLULU DISTRICT
POSITION ORGANIZATION CHART

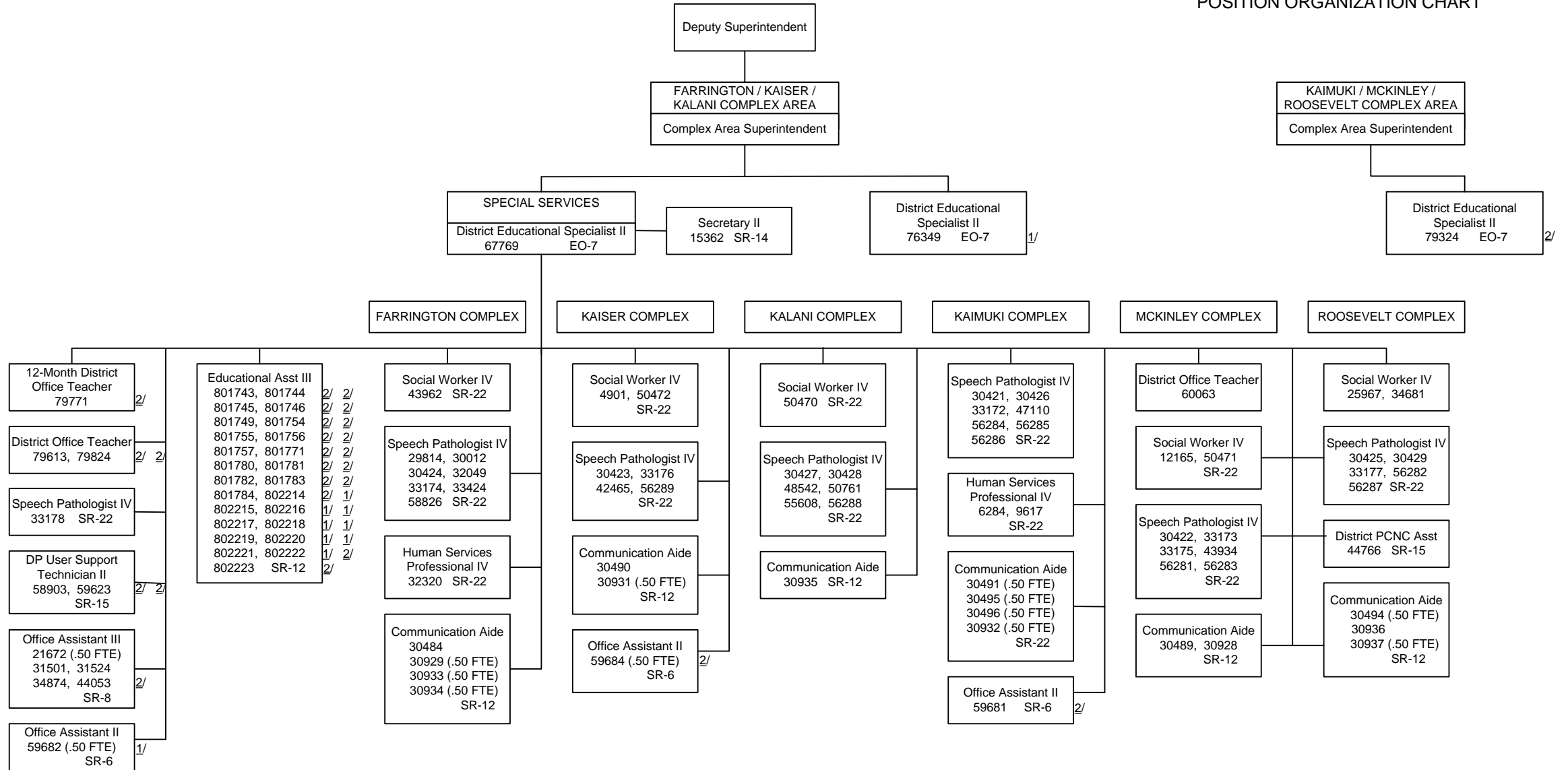

1/ Temporary position, General funds
2/ Temporary position, Federal funds

Department of Education
Organizational Chart

Table 24

STATE OF HAWAII
DEPARTMENT OF EDUCATION
OFFICE OF THE DEPUTY SUPERINTENDENT
HONOLULU DISTRICT
POSITION ORGANIZATION CHART

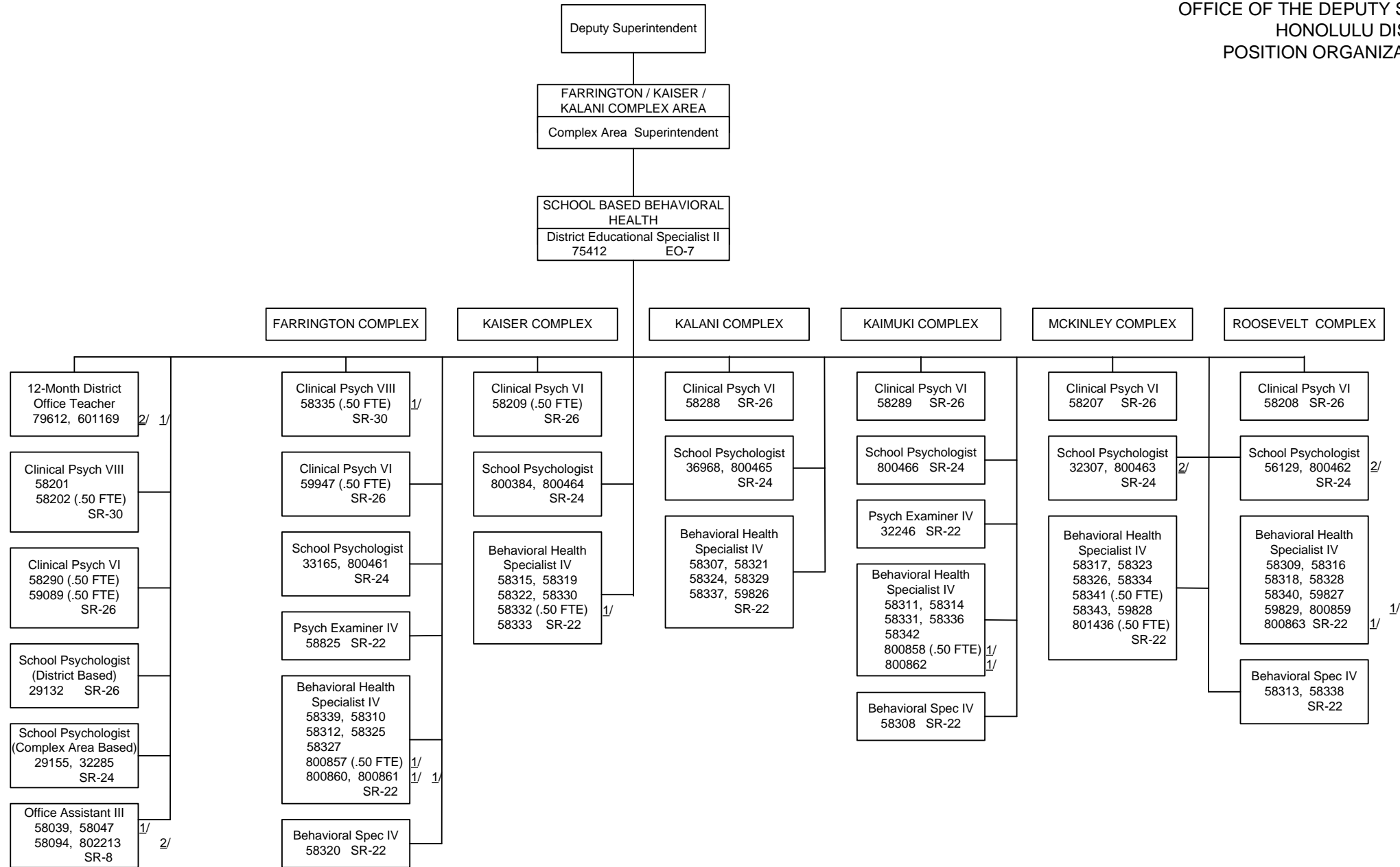

1/ Temporary position, General funds
2/ Temporary position, Federal funds

Department of Education
Organizational Chart

Table 24

STATE OF HAWAII
DEPARTMENT OF EDUCATION
OFFICE OF THE DEPUTY SUPERINTENDENT
HONOLULU DISTRICT
POSITION ORGANIZATION CHART

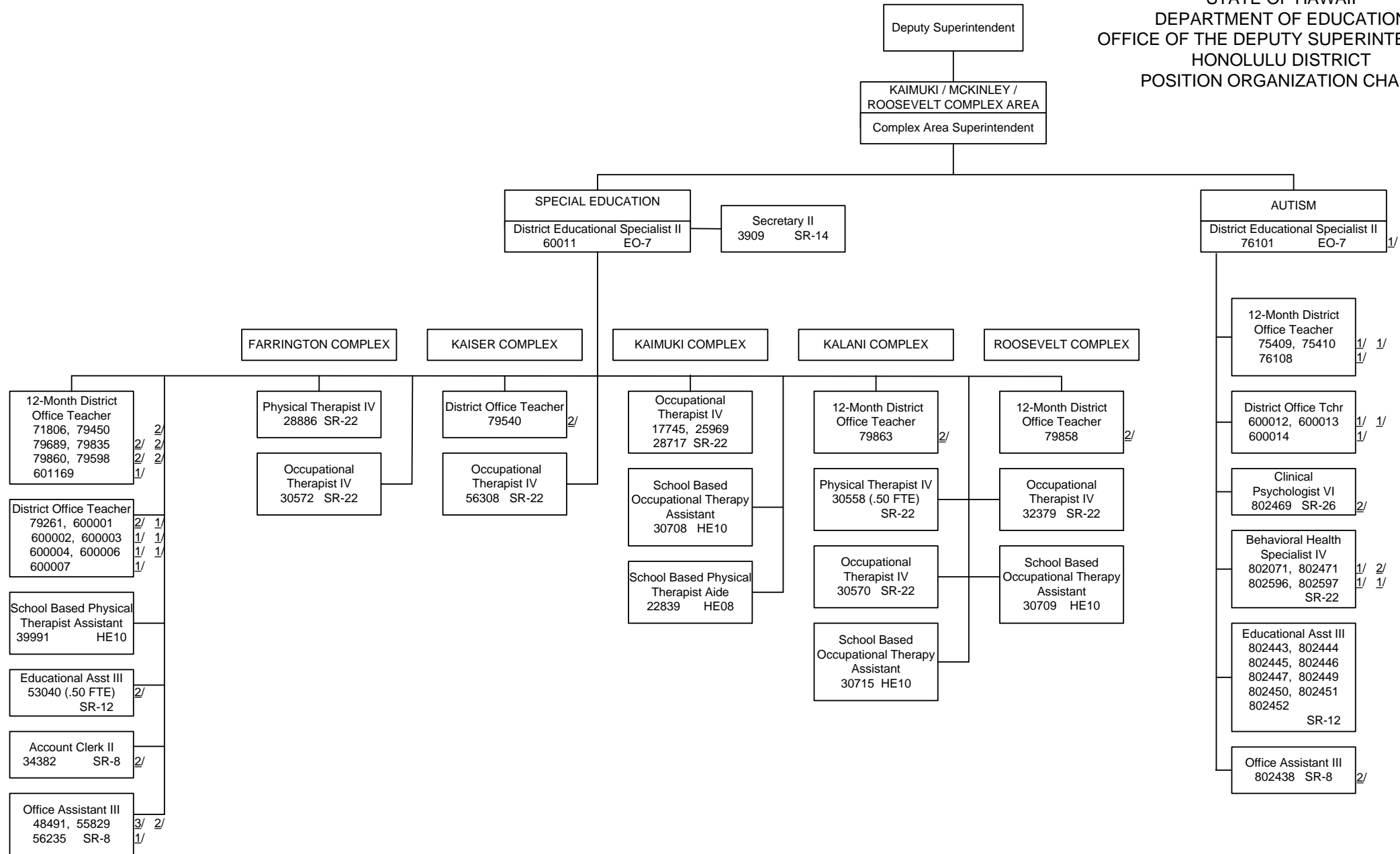

1/ Temporary position, General funds
2/ Temporary position, Federal funds
3/ Temporary position, Revolving funds

Department of Education
Organizational Chart

Table 24

STATE OF HAWAII
DEPARTMENT OF EDUCATION
OFFICE OF THE DEPUTY SUPERINTENDENT
HONOLULU DISTRICT
POSITION ORGANIZATION CHART

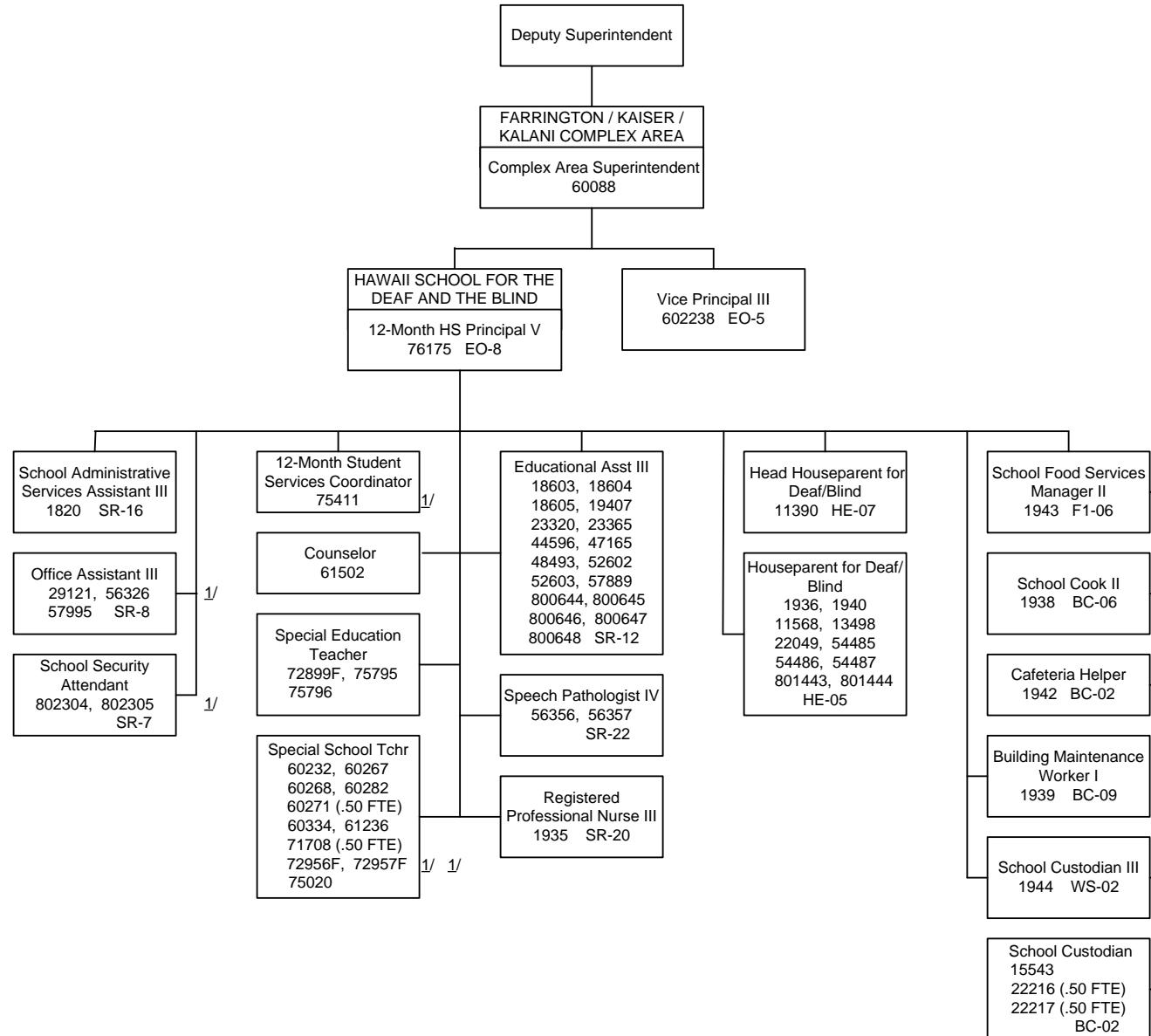

1/ Temporary position, General funds

STATE OF HAWAII
OFFICE OF THE DEPUTY SUPERINTENDENT
DEPARTMENT OF EDUCATION
CENTRAL DISTRICT
ORGANIZATION CHART

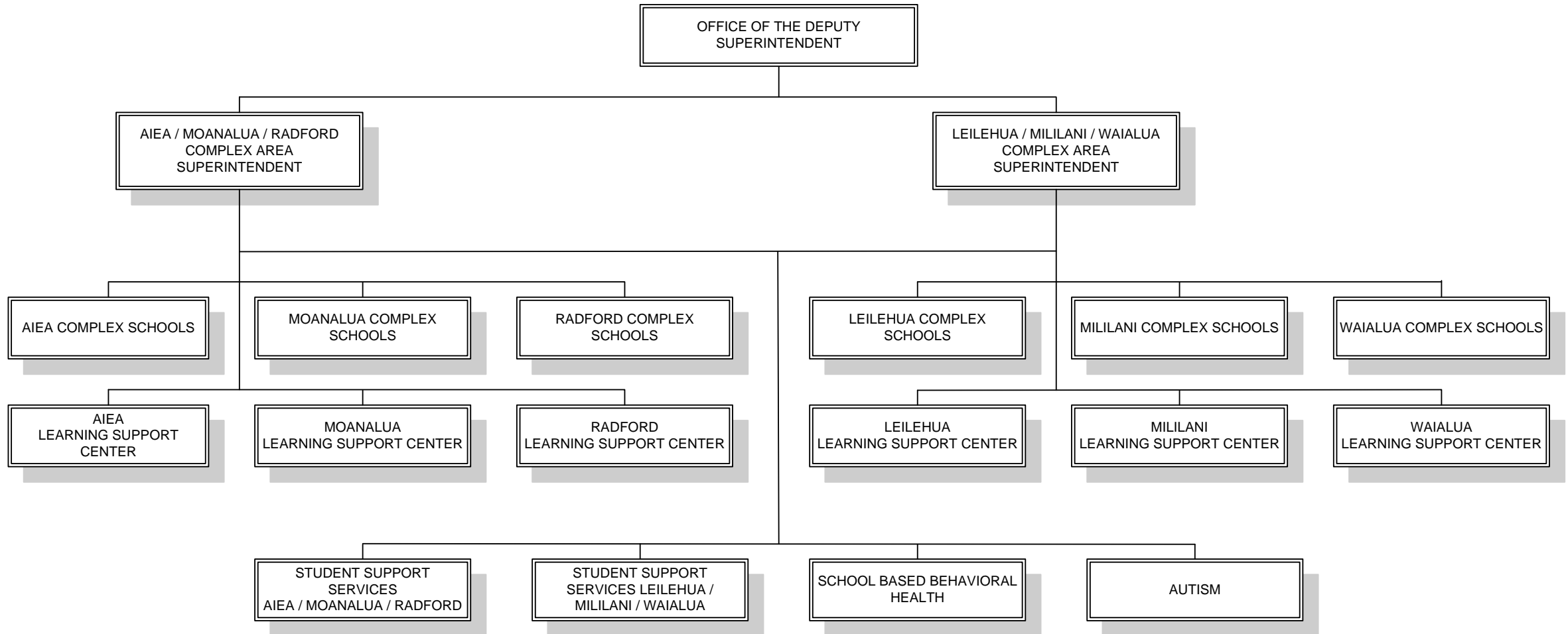

Department of Education
Organizational Chart

Table 24

STATE OF HAWAII
OFFICE OF THE DEPUTY SUPERINTENDENT
DEPARTMENT OF EDUCATION
CENTRAL DISTRICT
POSITION ORGANIZATION CHART

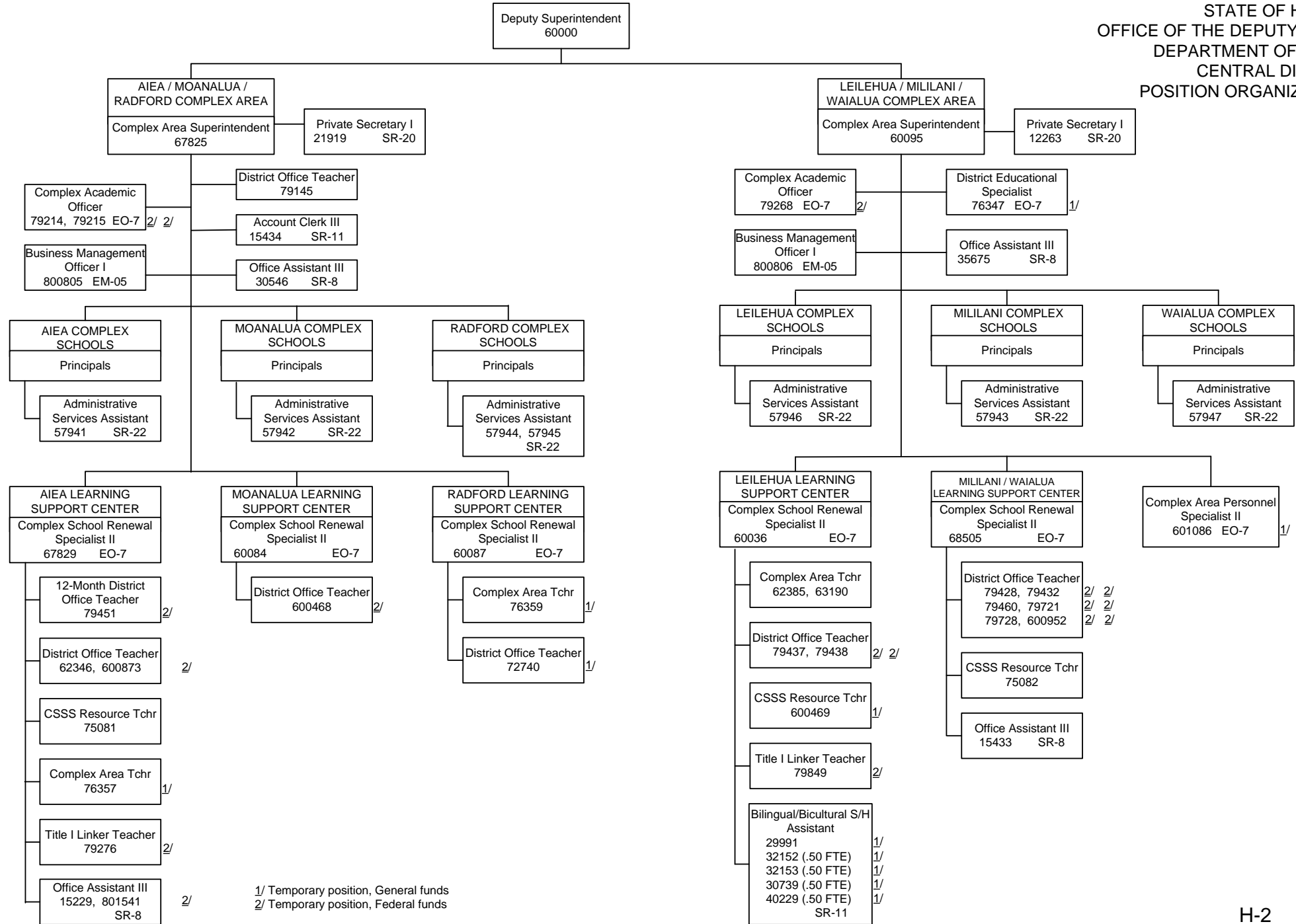

1/ Temporary position, General funds
2/ Temporary position, Federal funds

Department of Education
Organizational Chart

Table 24

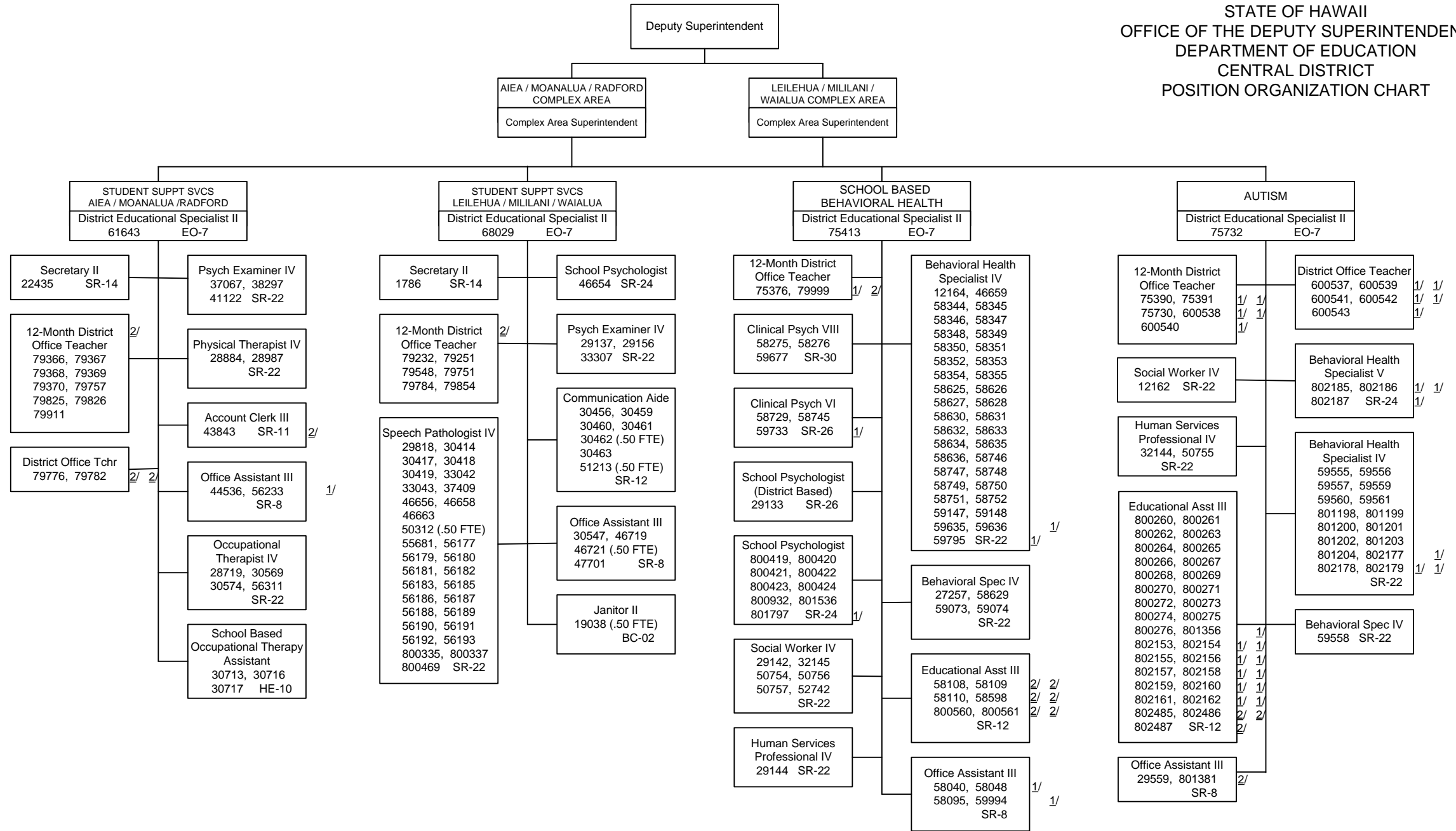

1/ Temporary position, General funds
2/ Temporary position, Federal funds

STATE OF HAWAII
DEPARTMENT OF EDUCATION
OFFICE OF THE DEPUTY SUPERINTENDENT
LEEWARD DISTRICT
ORGANIZATION CHART

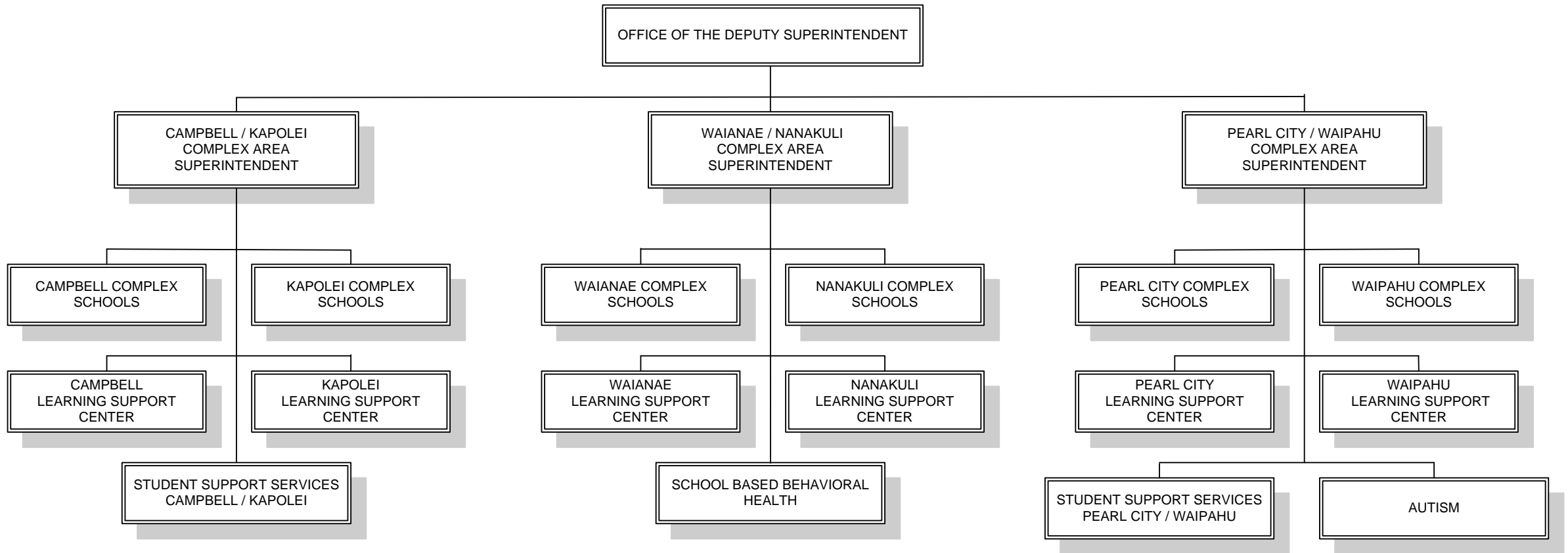

Department of Education
Organizational Chart

Table 24

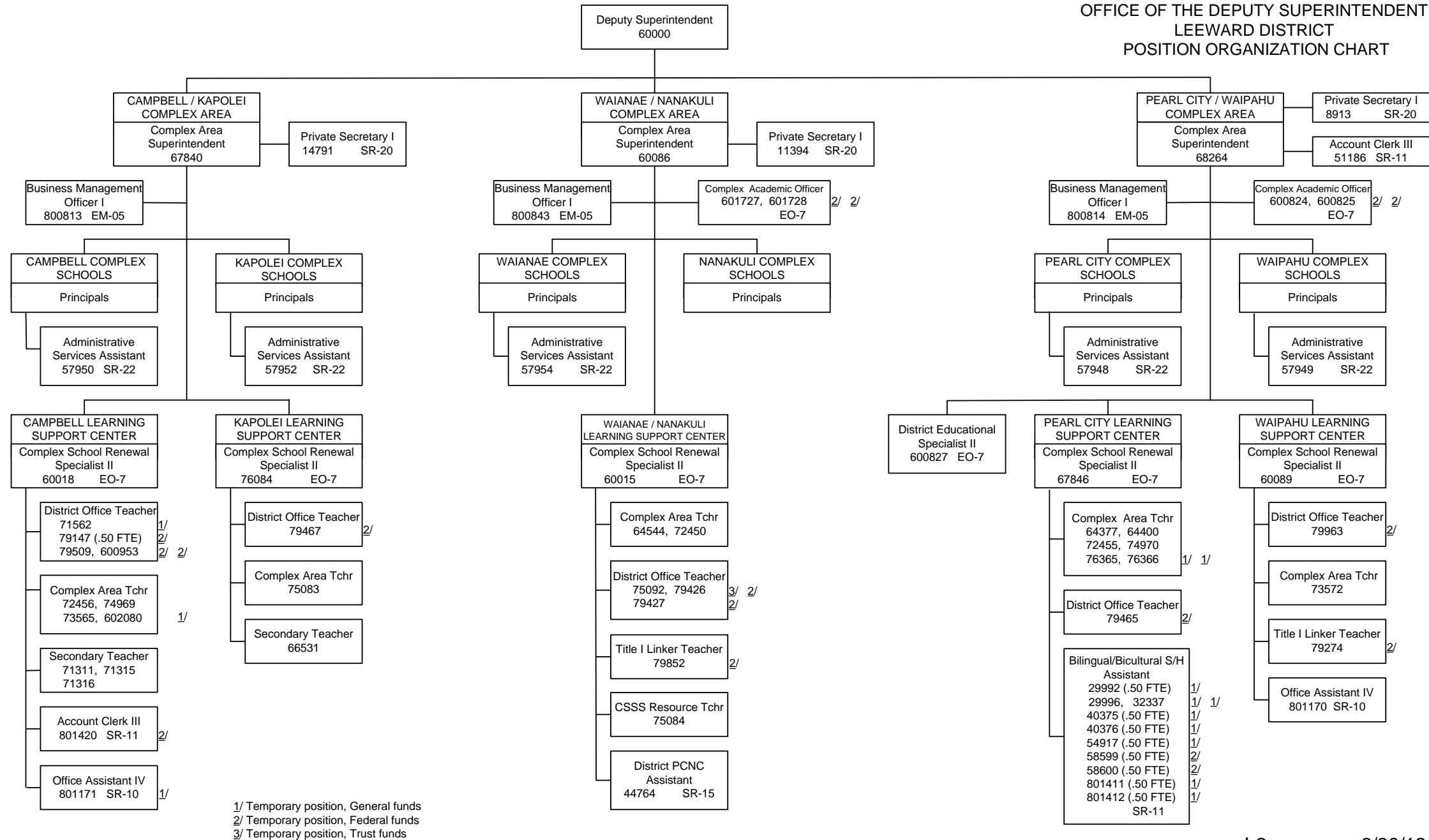

Department of Education
Organizational Chart

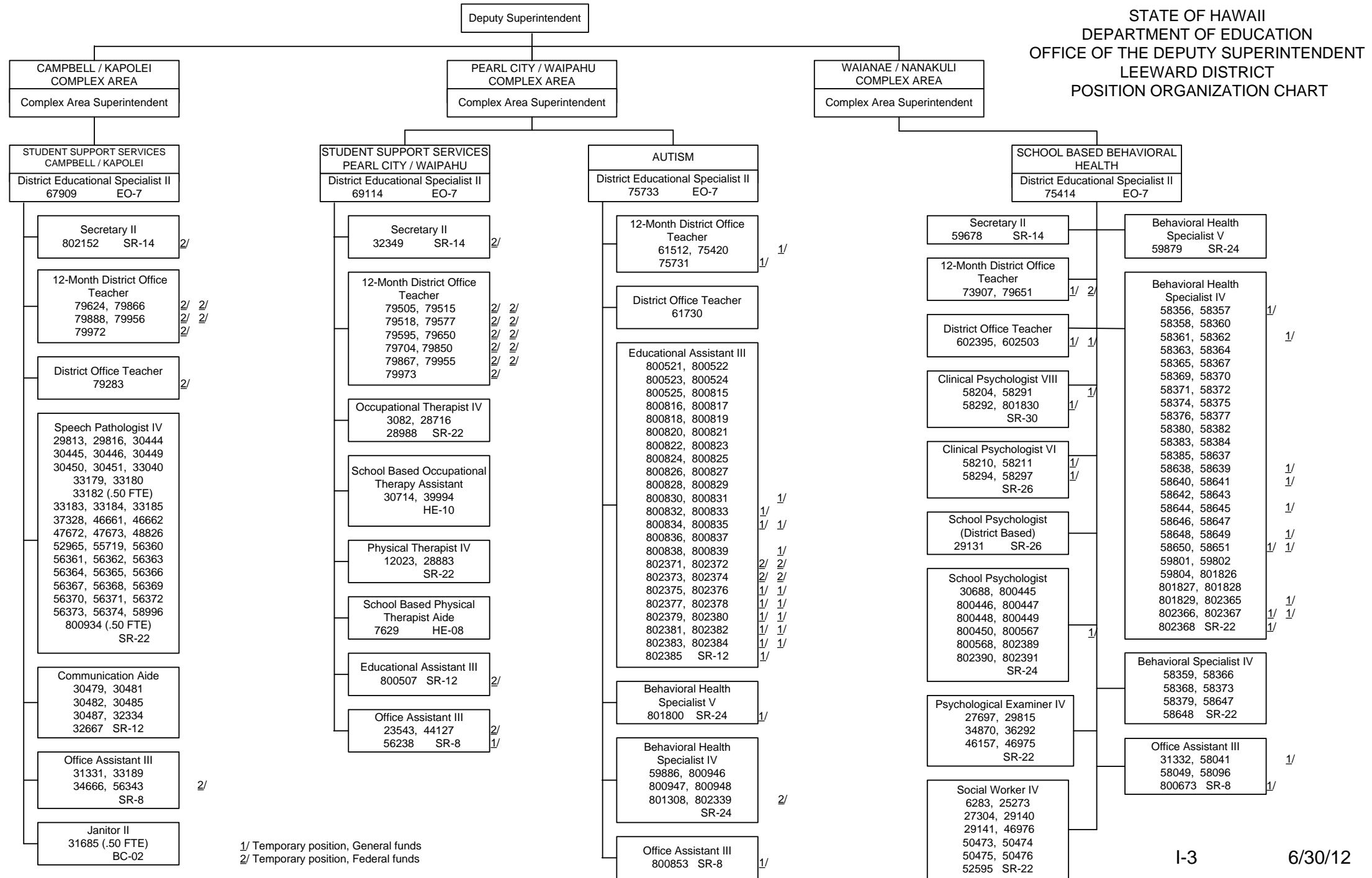

1/ Temporary position, General funds
2/ Temporary position, Federal funds

STATE OF HAWAII
DEPARTMENT OF EDUCATION
OFFICE OF THE DEPUTY SUPERINTENDENT
WINDWARD DISTRICT
ORGANIZATION CHART

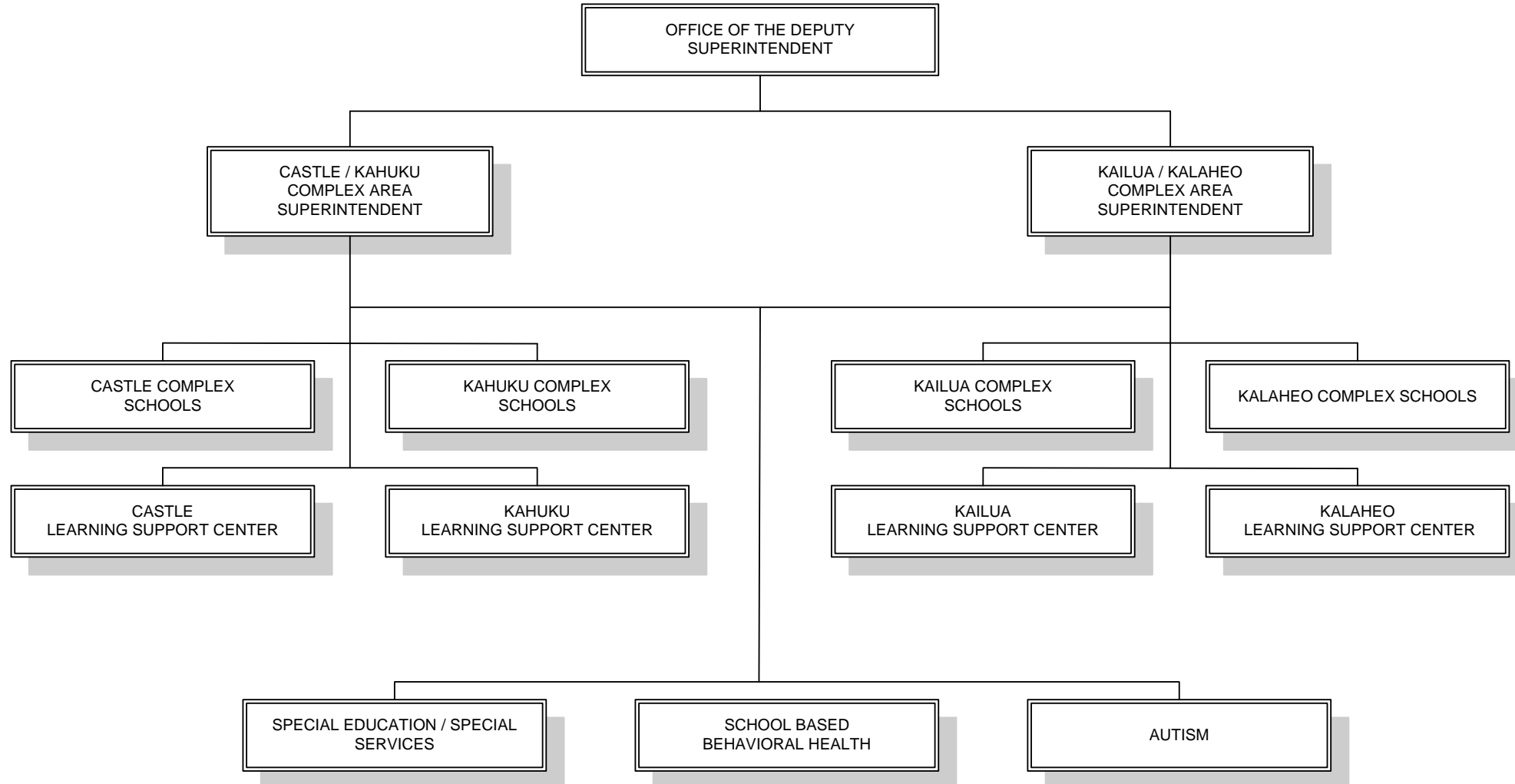

STATE OF HAWAII
DEPARTMENT OF EDUCATION
OFFICE OF THE DEPUTY SUPERINTENDENT
WINDWARD DISTRICT
POSITION ORGANIZATION CHART

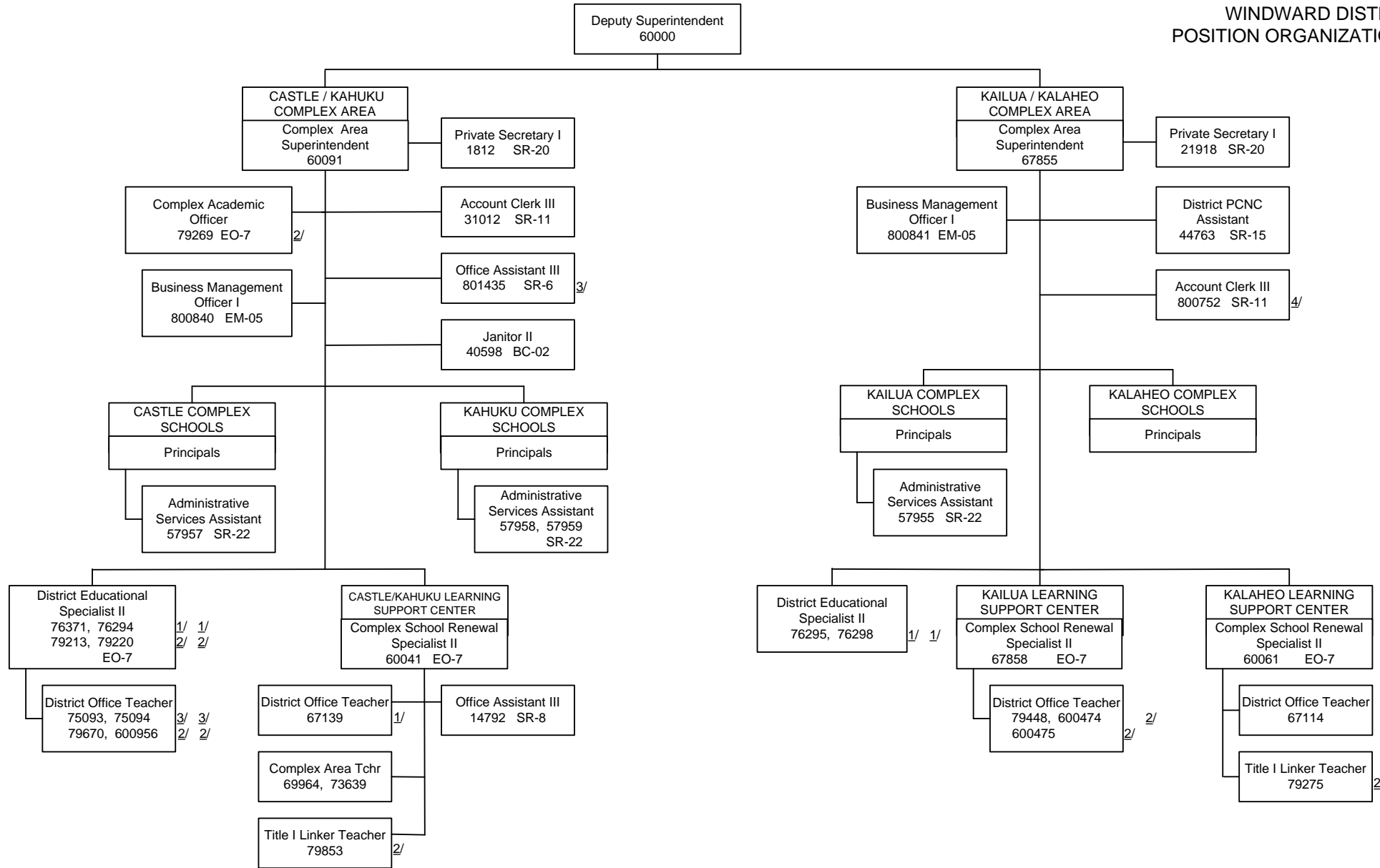

1/ Temporary position, General funds
2/ Temporary position, Federal funds
3/ Temporary position, Trust funds
4/ Temporary position, Revolving funds

Department of Education
Organizational Chart

Table 24

STATE OF HAWAII
DEPARTMENT OF EDUCATION
OFFICE OF THE DEPUTY SUPERINTENDENT
WINDWARD DISTRICT
POSITION ORGANIZATION CHART

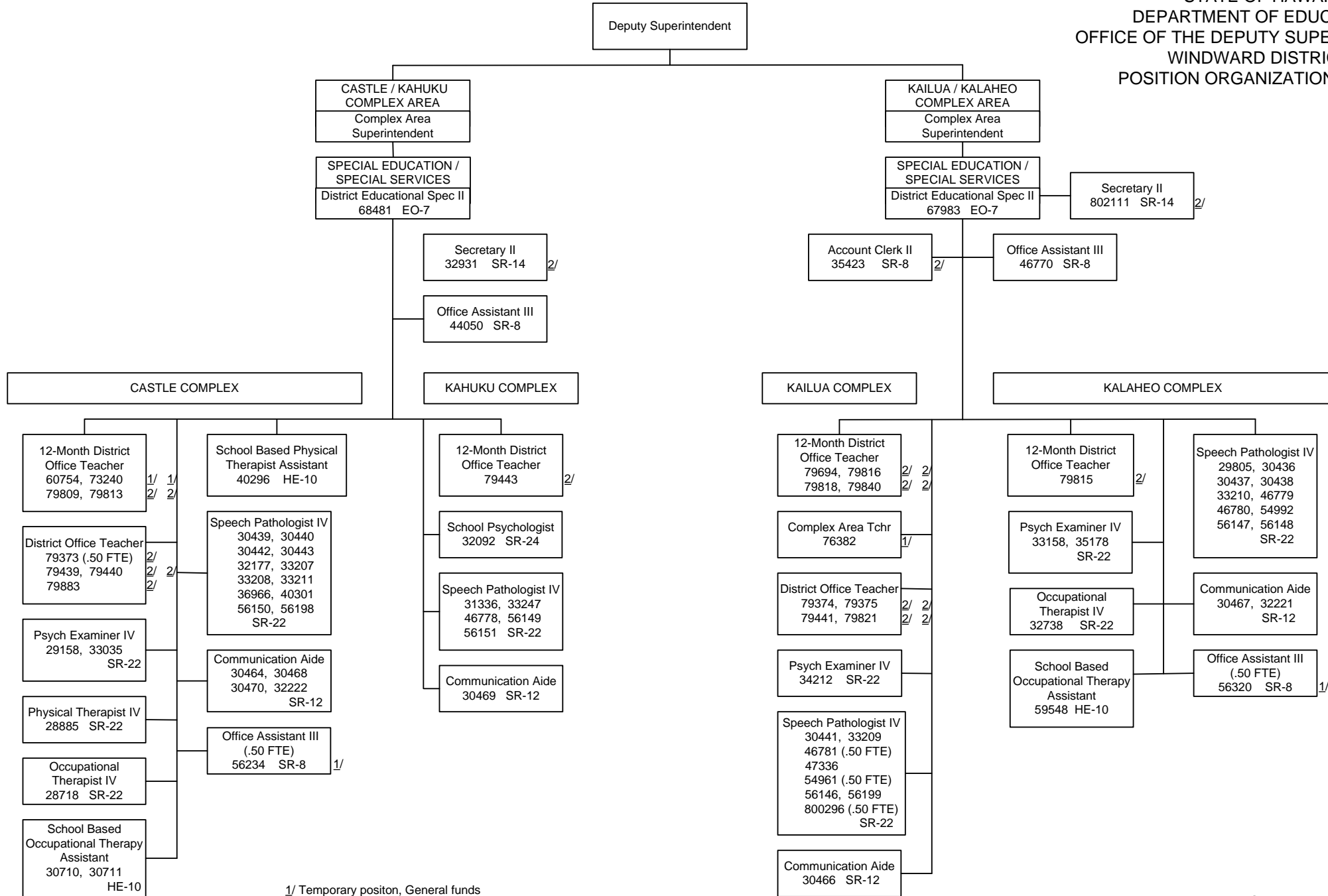

1/ Temporary position, General funds
2/ Temporary position, Federal funds

Department of Education
Organizational Chart

Table 24

STATE OF HAWAII
DEPARTMENT OF EDUCATION
OFFICE OF THE DEPUTY SUPERINTENDENT
WINDWARD DISTRICT
POSITION ORGANIZATION CHART

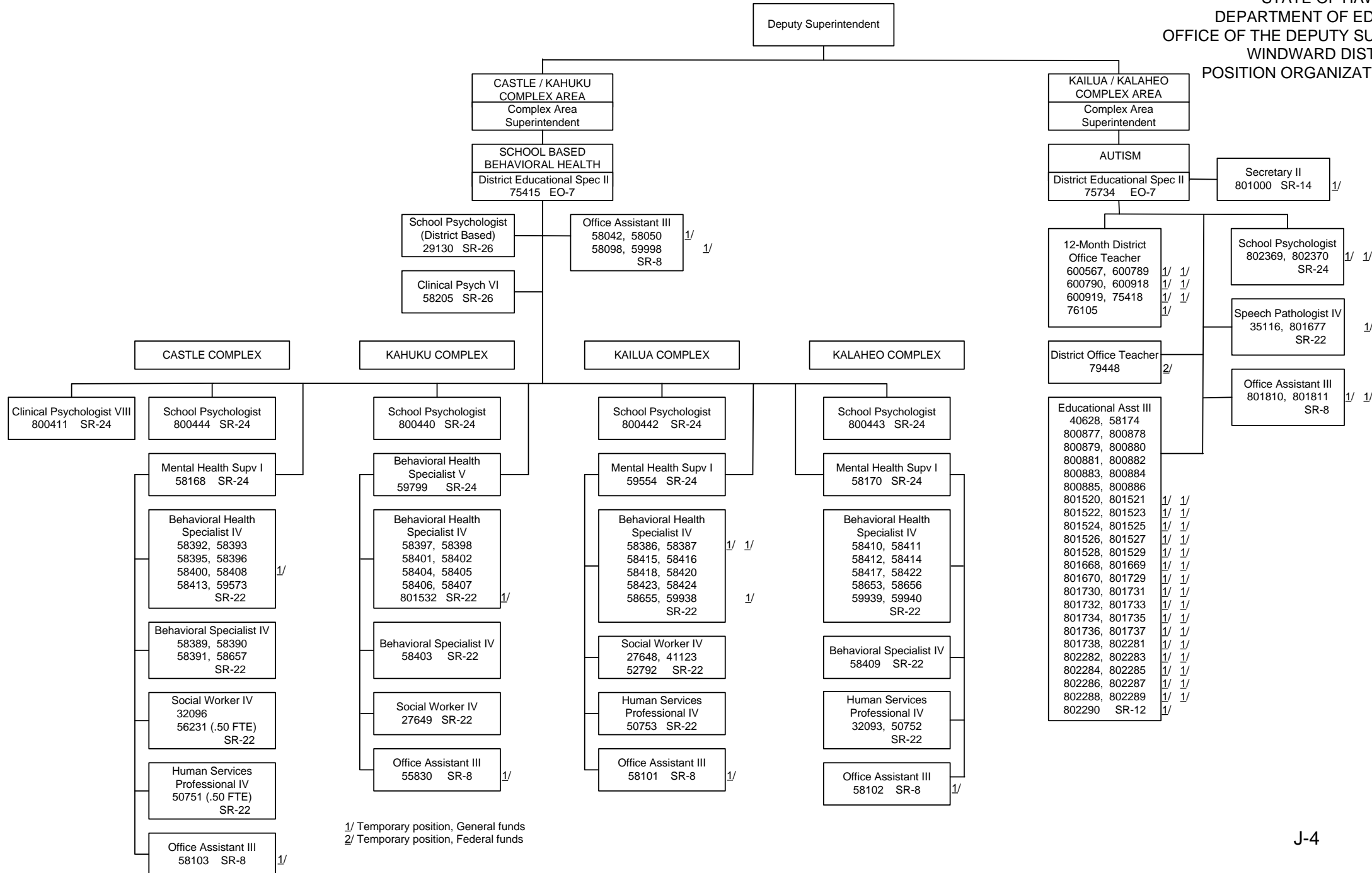

1/ Temporary position, General funds
2/ Temporary position, Federal funds

STATE OF HAWAII
DEPARTMENT OF EDUCATION
OFFICE OF THE DEPUTY SUPERINTENDENT
HAWAII DISTRICT
ORGANIZATION CHART

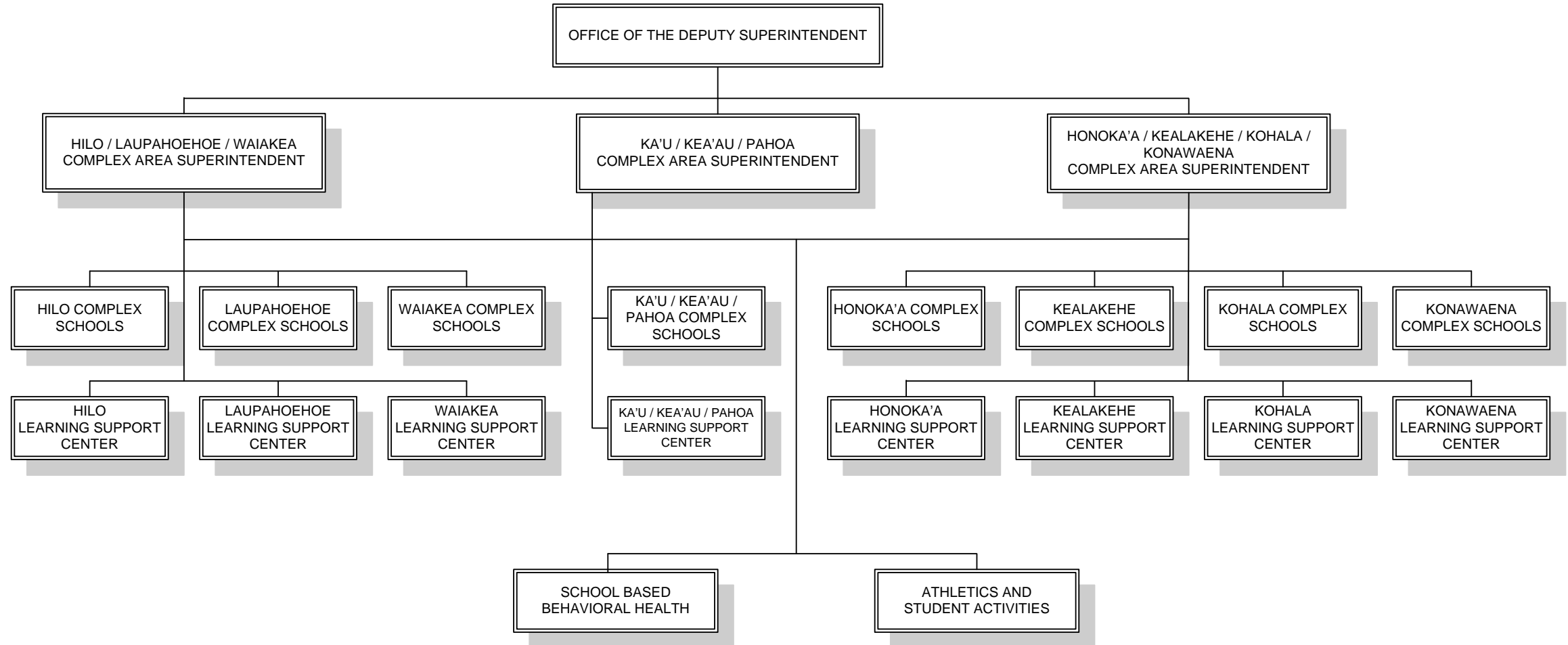

Department of Education
Organizational Chart

Table 24

STATE OF HAWAII
DEPARTMENT OF EDUCATION
OFFICE OF THE DEPUTY SUPERINTENDENT
HAWAII DISTRICT
POSITION ORGANIZATION CHART

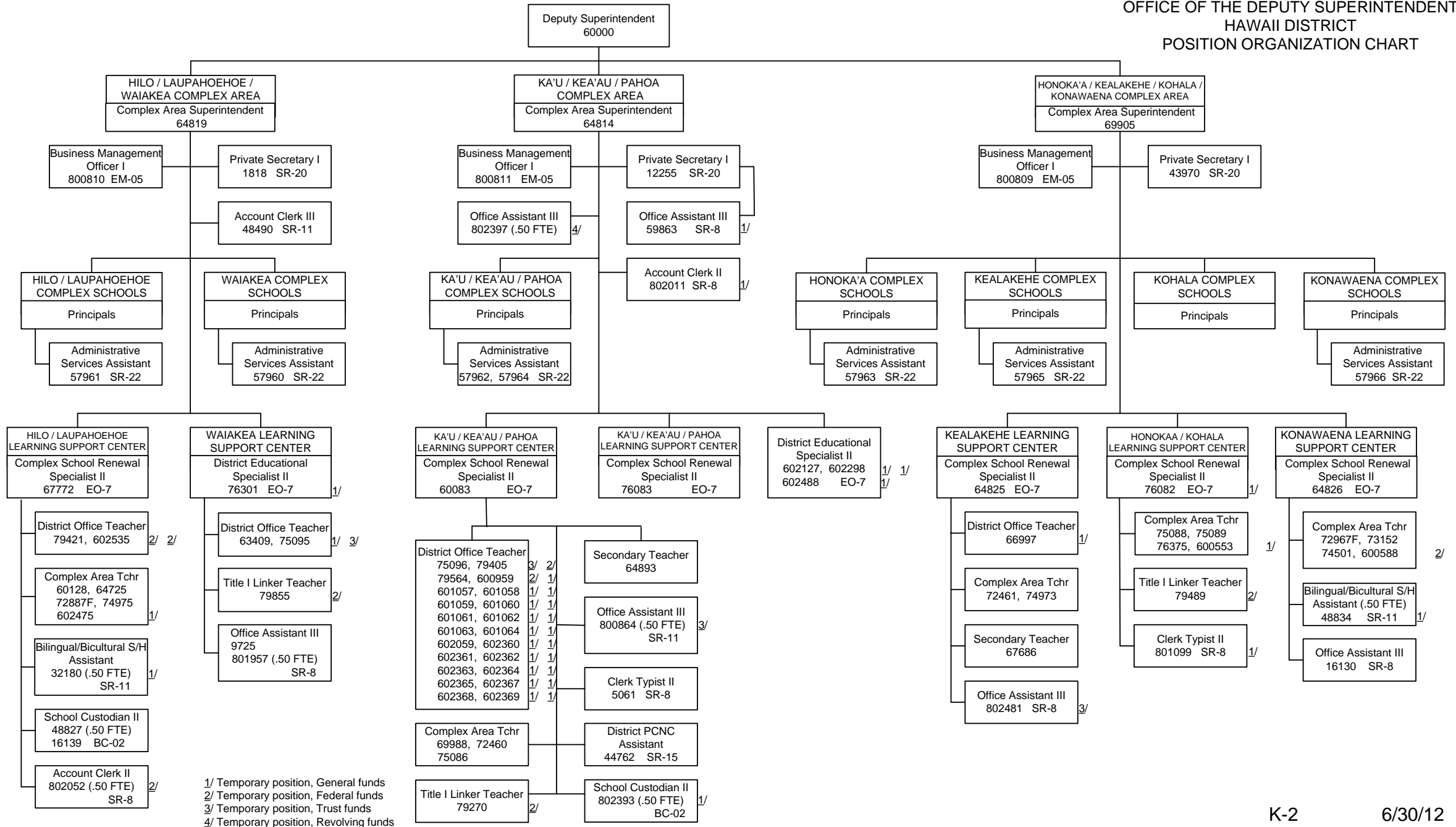

1/ Temporary position, General funds
2/ Temporary position, Federal funds
3/ Temporary position, Trust funds
4/ Temporary position, Revolving funds

Department of Education
Organizational Chart

Table 24

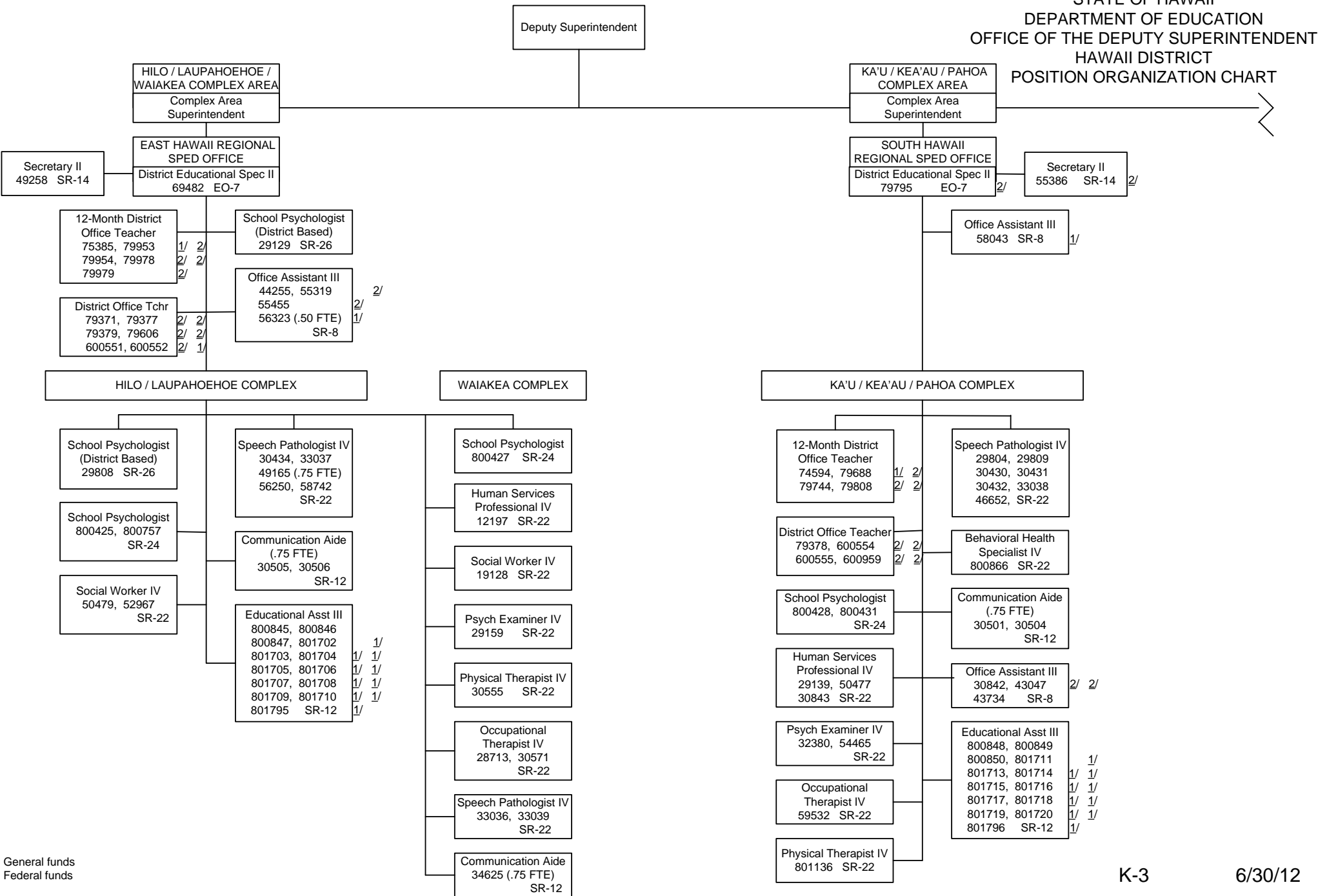

1/ Temporary position, General funds
2/ Temporary position, Federal funds

Department of Education
Organizational Chart

Table 24

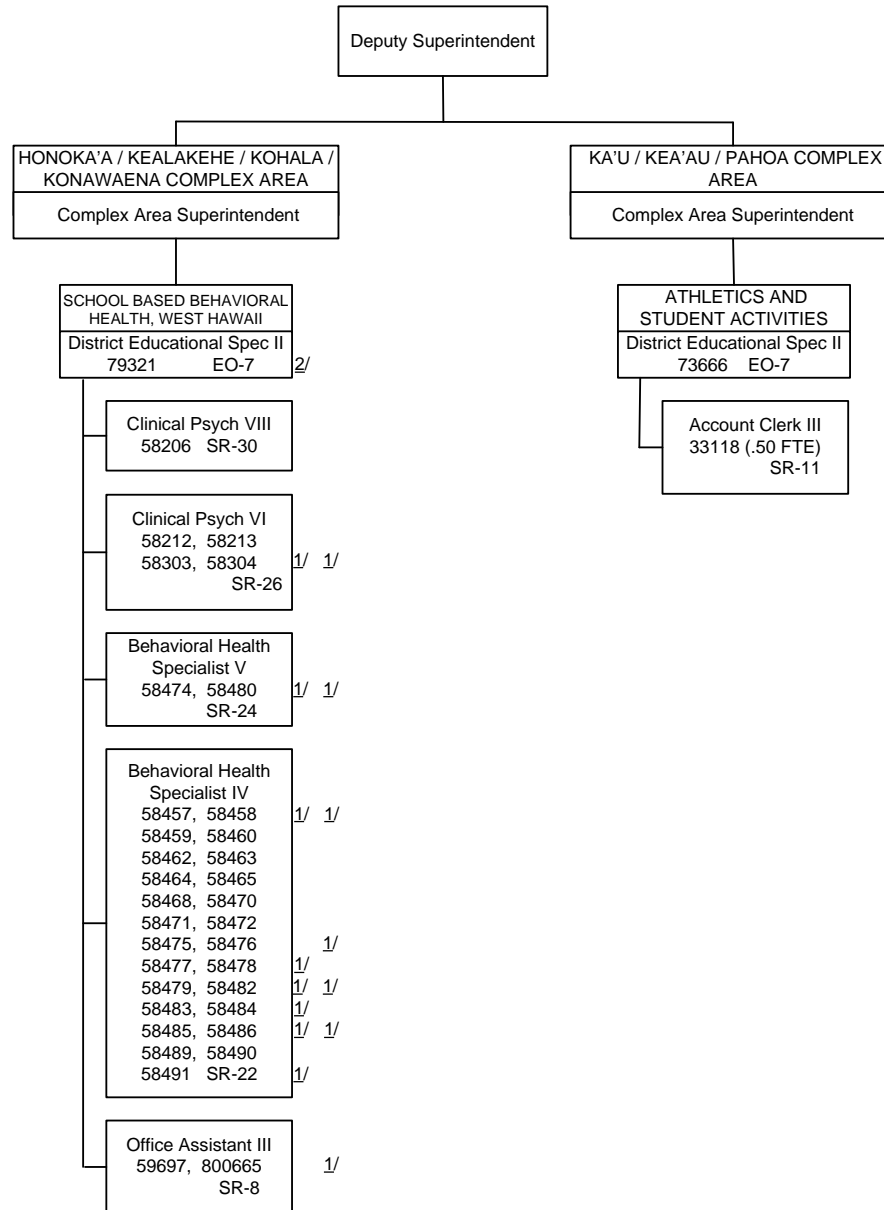

STATE OF HAWAII
DEPARTMENT OF EDUCATION
OFFICE OF THE DEPUTY SUPERINTENDENT
HAWAII DISTRICT
POSITION ORGANIZATION CHART

1/ Temporary position, General funds
2/ Temporary position, Federal funds

STATE OF HAWAII
DEPARTMENT OF EDUCATION
OFFICE OF THE DEPUTY SUPERINTENDENT
MAUI DISTRICT
ORGANIZATION CHART

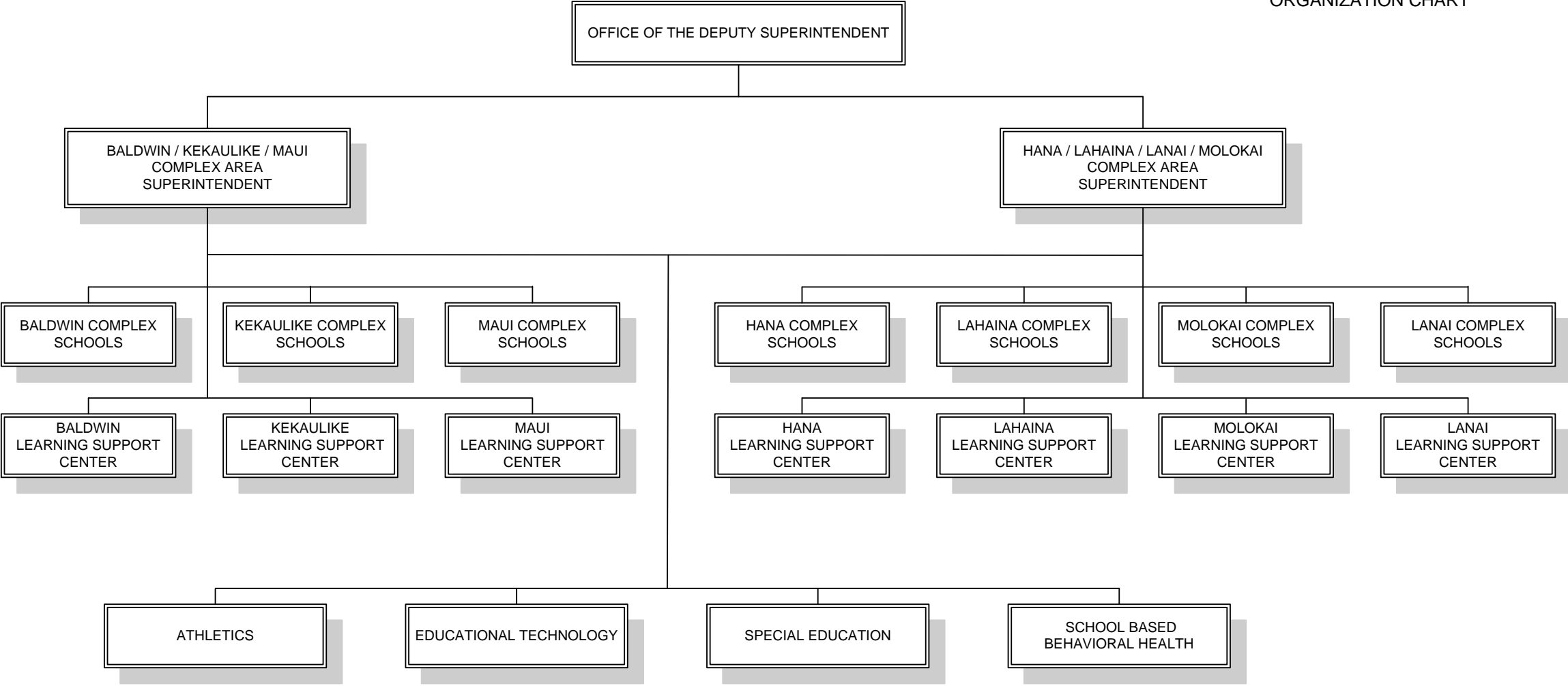

Department of Education
Organizational Chart

Table 24

STATE OF HAWAII
DEPARTMENT OF EDUCATION
OFFICE OF THE DEPUTY SUPERINTENDENT
MAUI DISTRICT
POSITION ORGANIZATION CHART

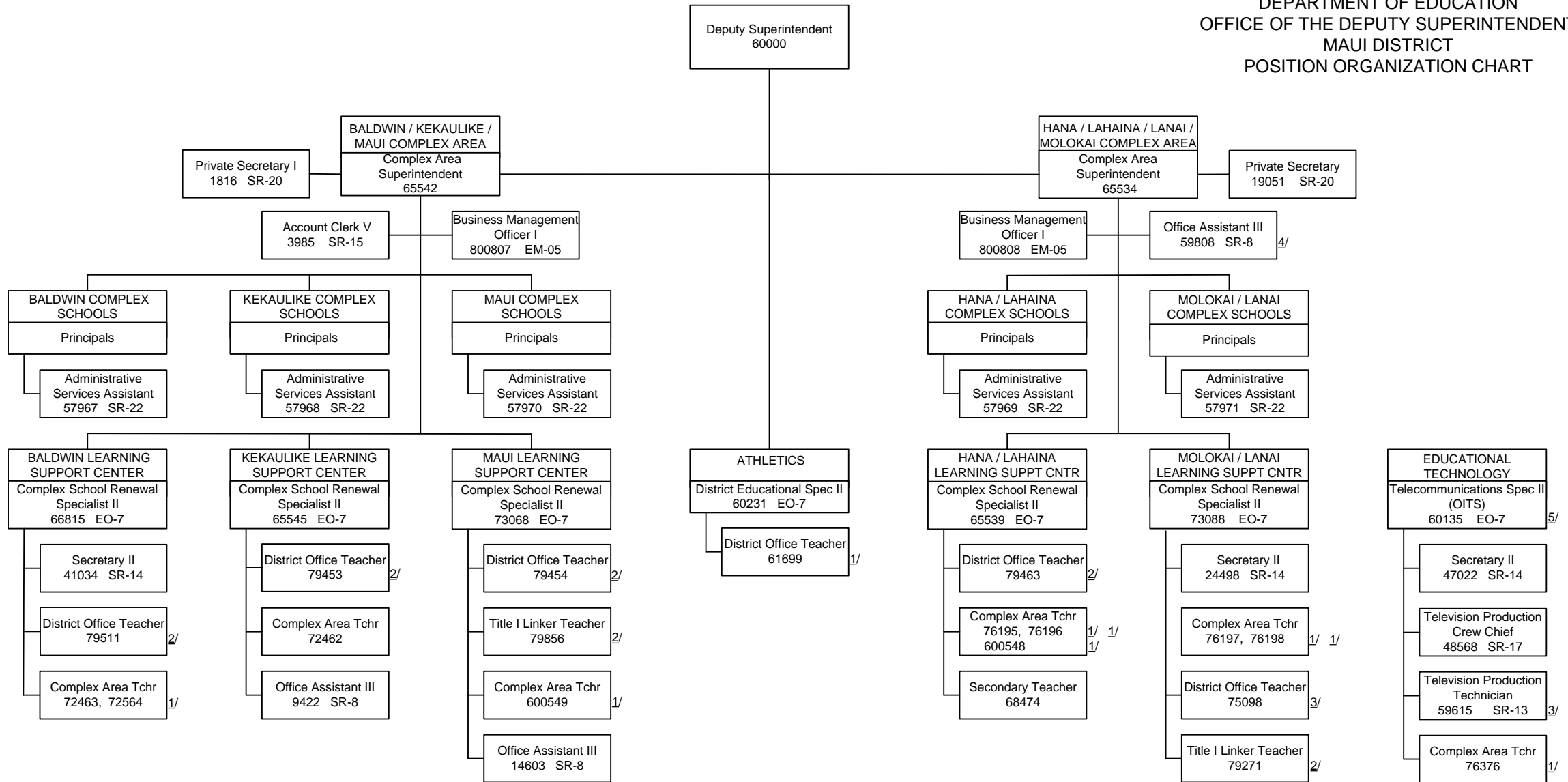

1/ Temporary position, General funds

2/ Temporary position, Federal funds

3/ Temporary position, Trust funds

4/ Temporary position, Revolving funds

5/ Position no. 60135 receives technical supervision from position no. 66355, Telecom Director, Office of Information Technology Services

Department of Education
Organizational Chart

Table 24

STATE OF HAWAII
DEPARTMENT OF EDUCATION
OFFICE OF THE DEPUTY SUPERINTENDENT
MAUI DISTRICT
POSITION ORGANIZATION CHART

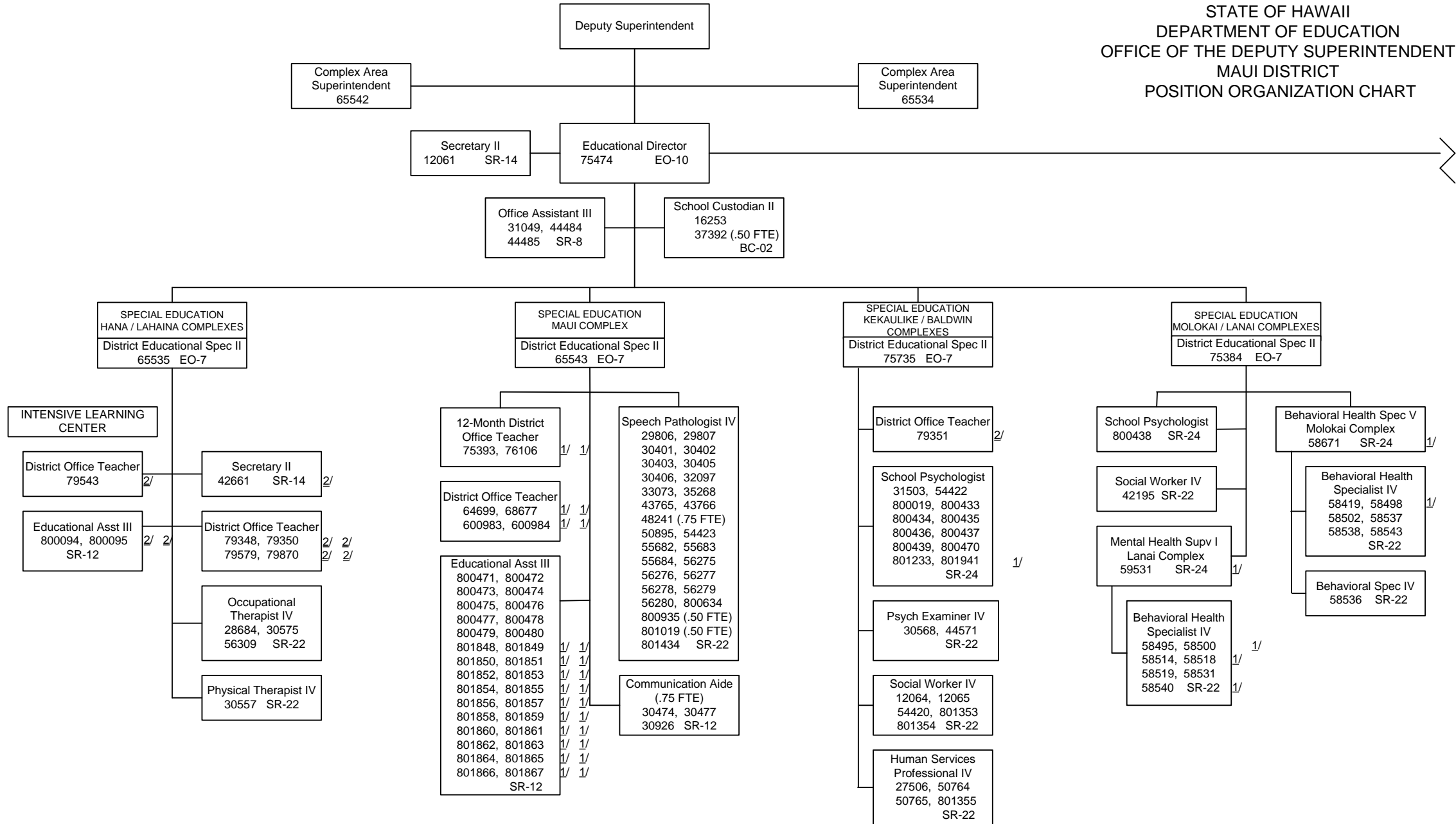

1/ Temporary position, General funds
2/ Temporary position, Federal funds

STATE OF HAWAII
DEPARTMENT OF EDUCATION
OFFICE OF THE DEPUTY SUPERINTENDENT
MAUI DISTRICT
POSITION ORGANIZATION CHART

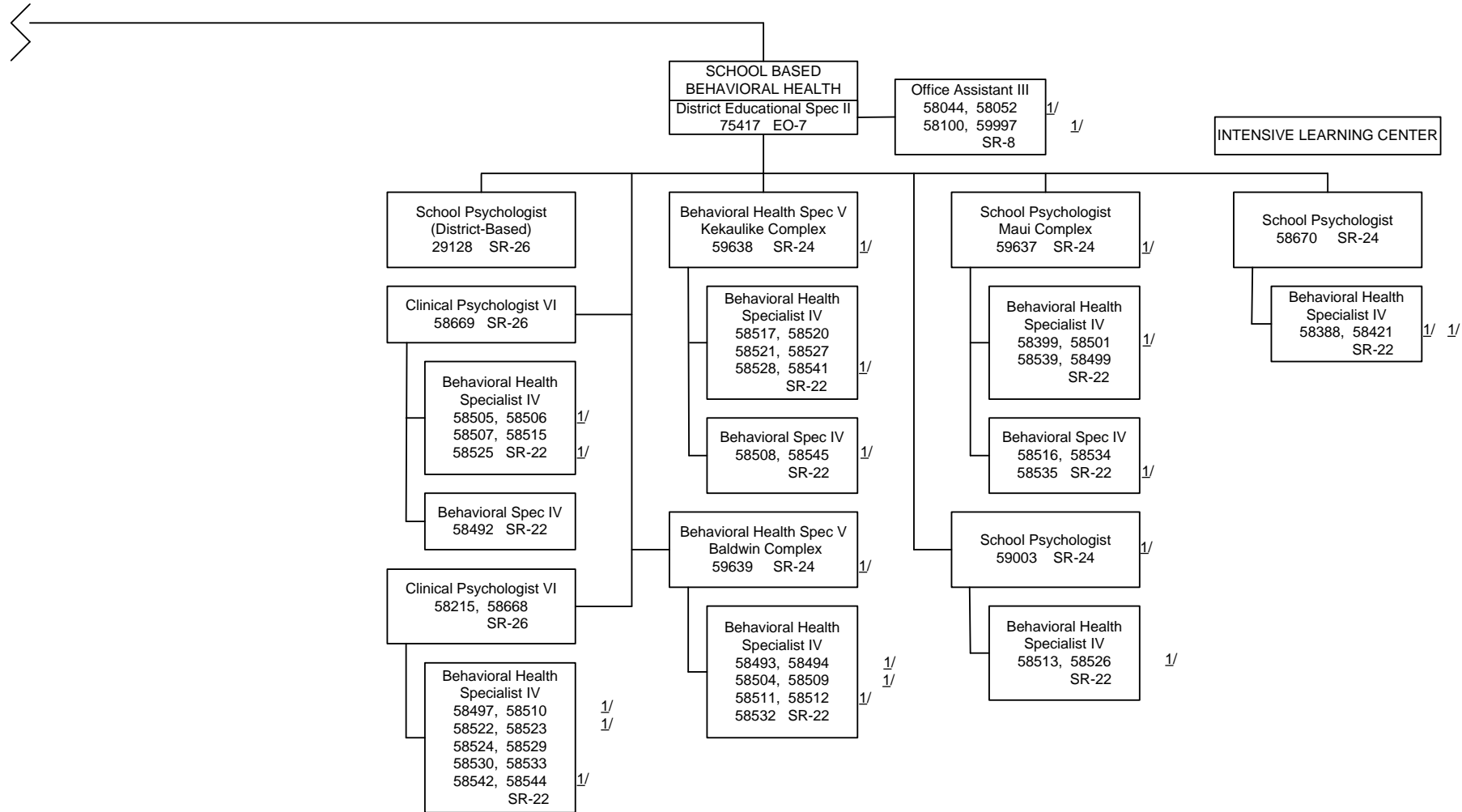

1/ Temporary position, General funds

STATE OF HAWAII
OFFICE OF THE DEPUTY SUPERINTENDENT
DEPARTMENT OF EDUCATION
KAUAI DISTRICT
ORGANIZATION CHART

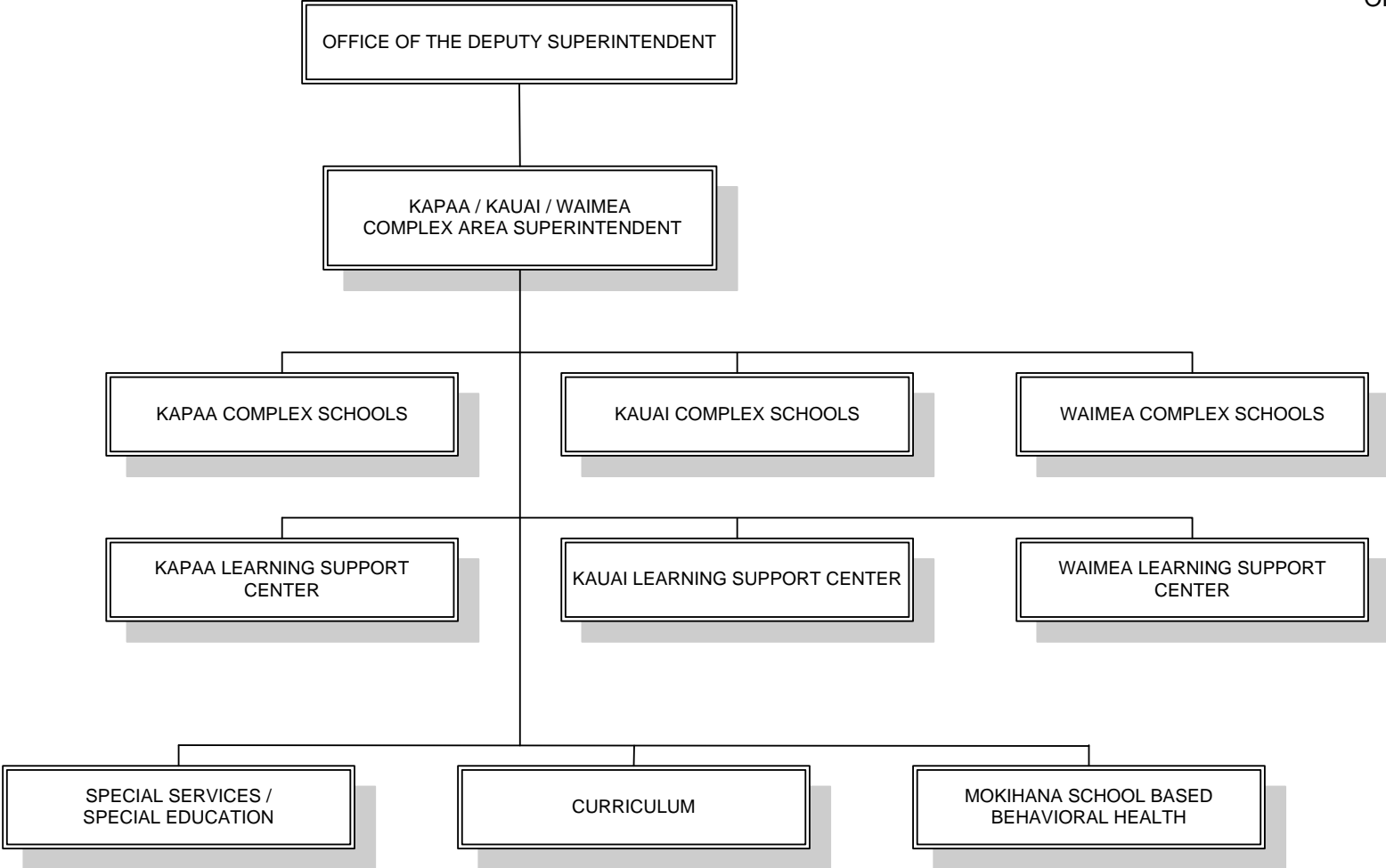

Department of Education
Organizational Chart

Table 24

STATE OF HAWAII
DEPARTMENT OF EDUCATION
OFFICE OF THE DEPUTY SUPERINTENDENT
KAUAI DISTRICT
POSITION ORGANIZATION CHART

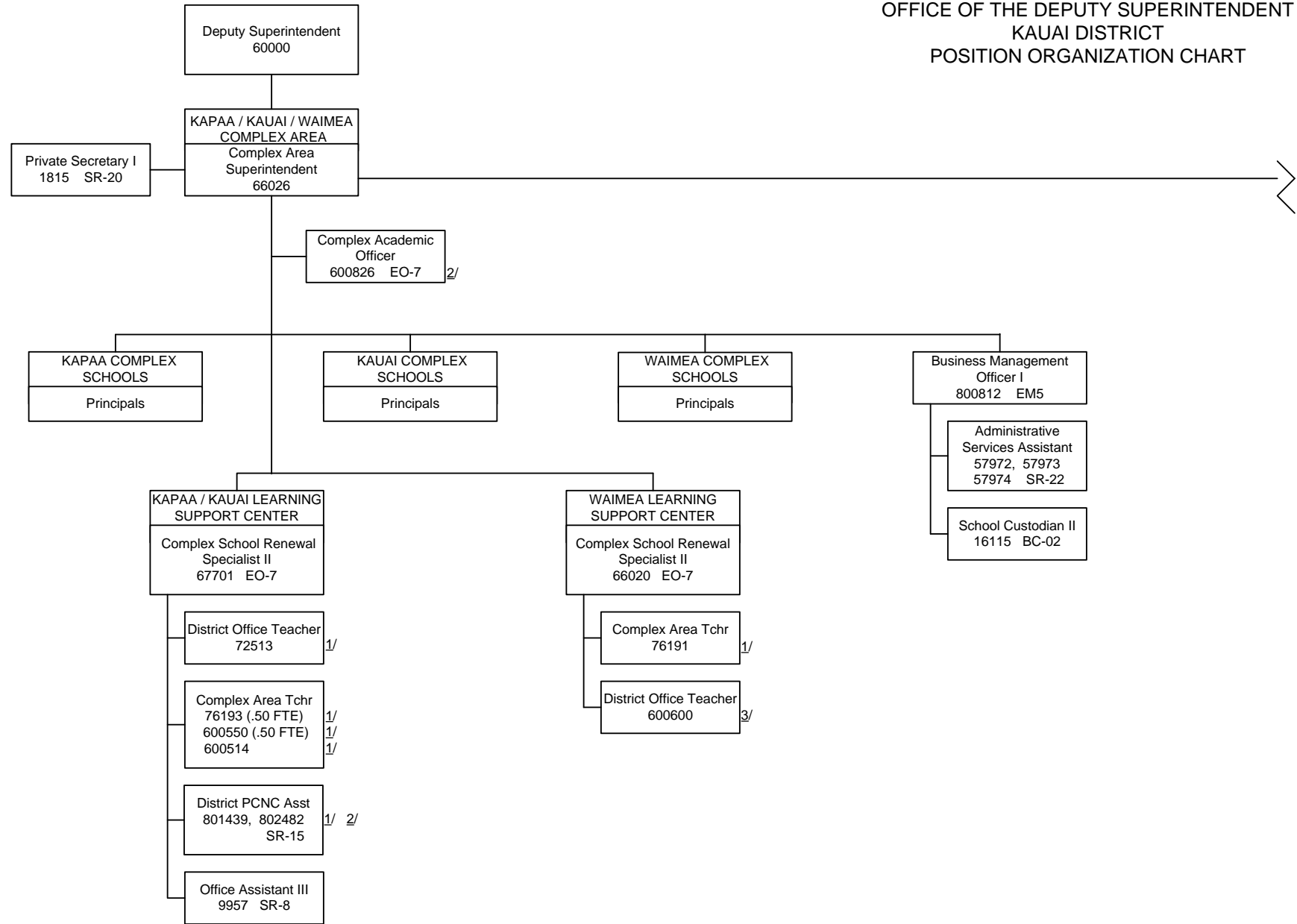

1/ Temporary position, General funds
2/ Temporary position, Federal funds
3/ Temporary position, Trust funds

STATE OF HAWAII
DEPARTMENT OF EDUCATION
OFFICE OF THE DEPUTY SUPERINTENDENT
KAUAI DISTRICT
POSITION ORGANIZATION CHART

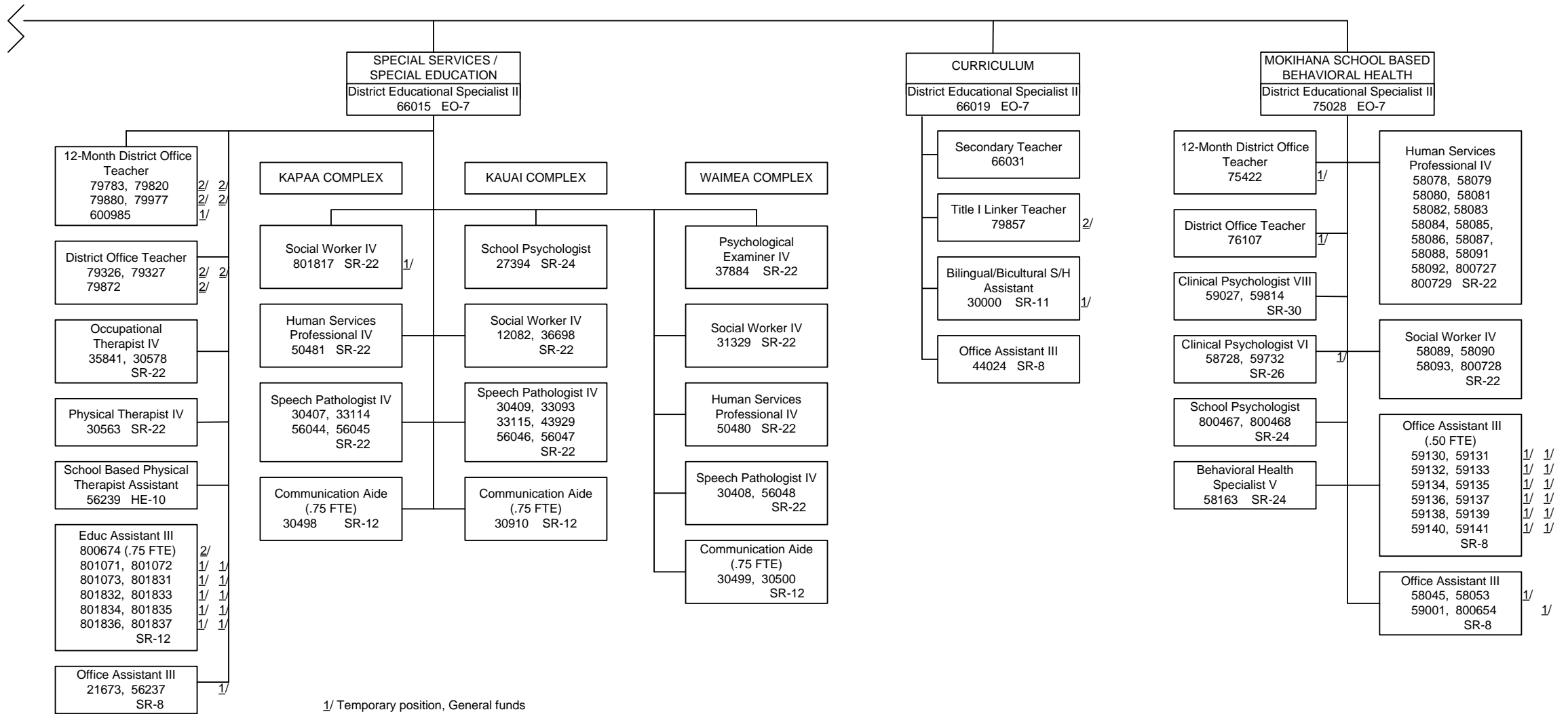

1/ Temporary position, General funds
2/ Temporary position, Federal funds

STATE OF HAWAII
DEPARTMENT OF EDUCATION
OFFICE OF THE "SENIOR" ASSISTANT SUPERINTENDENT
FOR ADMINISTRATIVE AFFAIRS
ORGANIZATION CHART

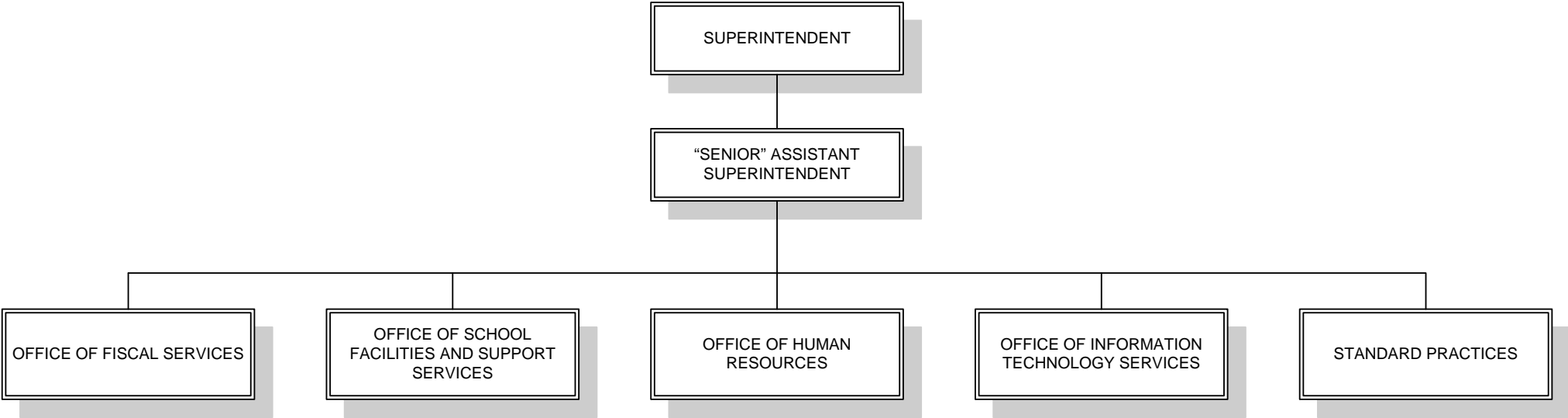

STATE OF HAWAII
DEPARTMENT OF EDUCATION
OFFICE OF THE "SENIOR" ASSISTANT SUPERINTENDENT
FOR ADMINISTRATIVE AFFAIRS
POSITION ORGANIZATION CHART

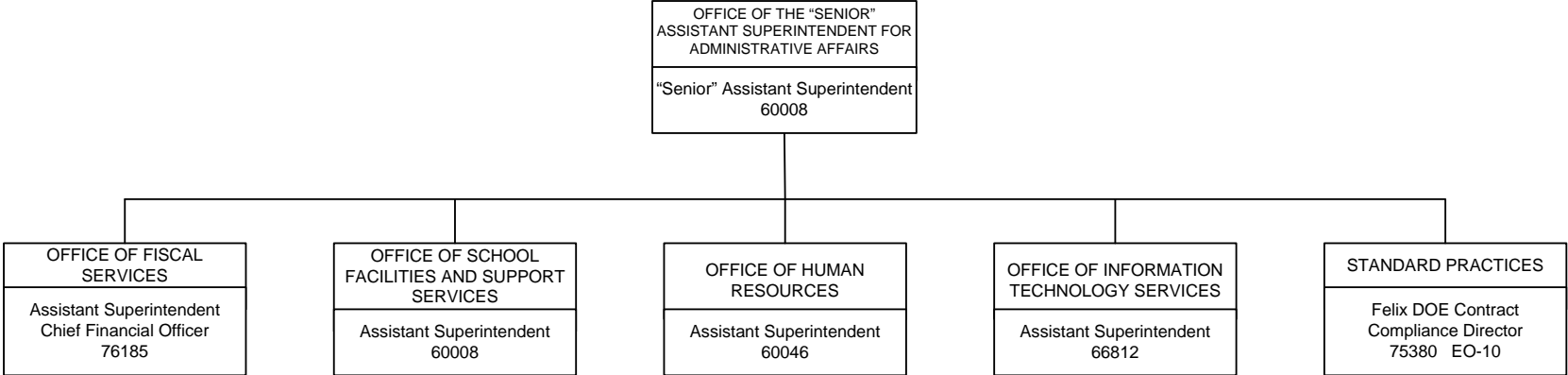

Department of Education
Organizational Chart

Table 24

STATE OF HAWAII
DEPARTMENT OF EDUCATION
OFFICE OF THE "SENIOR" ASSISTANT SUPERINTENDENT
FOR ADMINISTRATIVE AFFAIRS
OFFICE OF FISCAL SERVICES
ORGANIZATION CHART

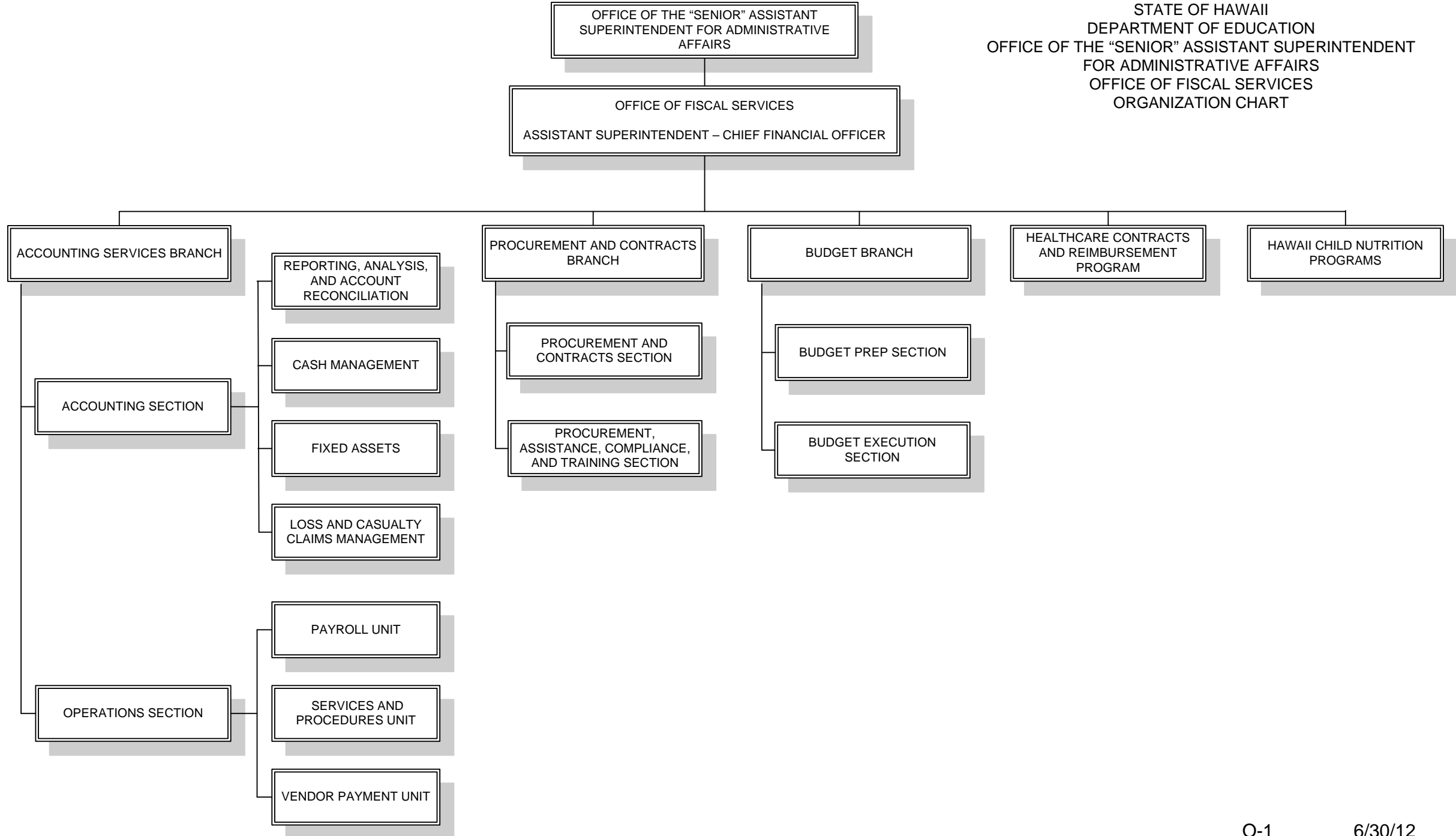

Department of Education
Organizational Chart

Table 24

STATE OF HAWAII
DEPARTMENT OF EDUCATION
OFFICE OF THE "SENIOR" ASSISTANT SUPERINTENDENT
FOR ADMINISTRATIVE AFFAIRS
OFFICE OF FISCAL SERVICES
POSITION ORGANIZATION CHART

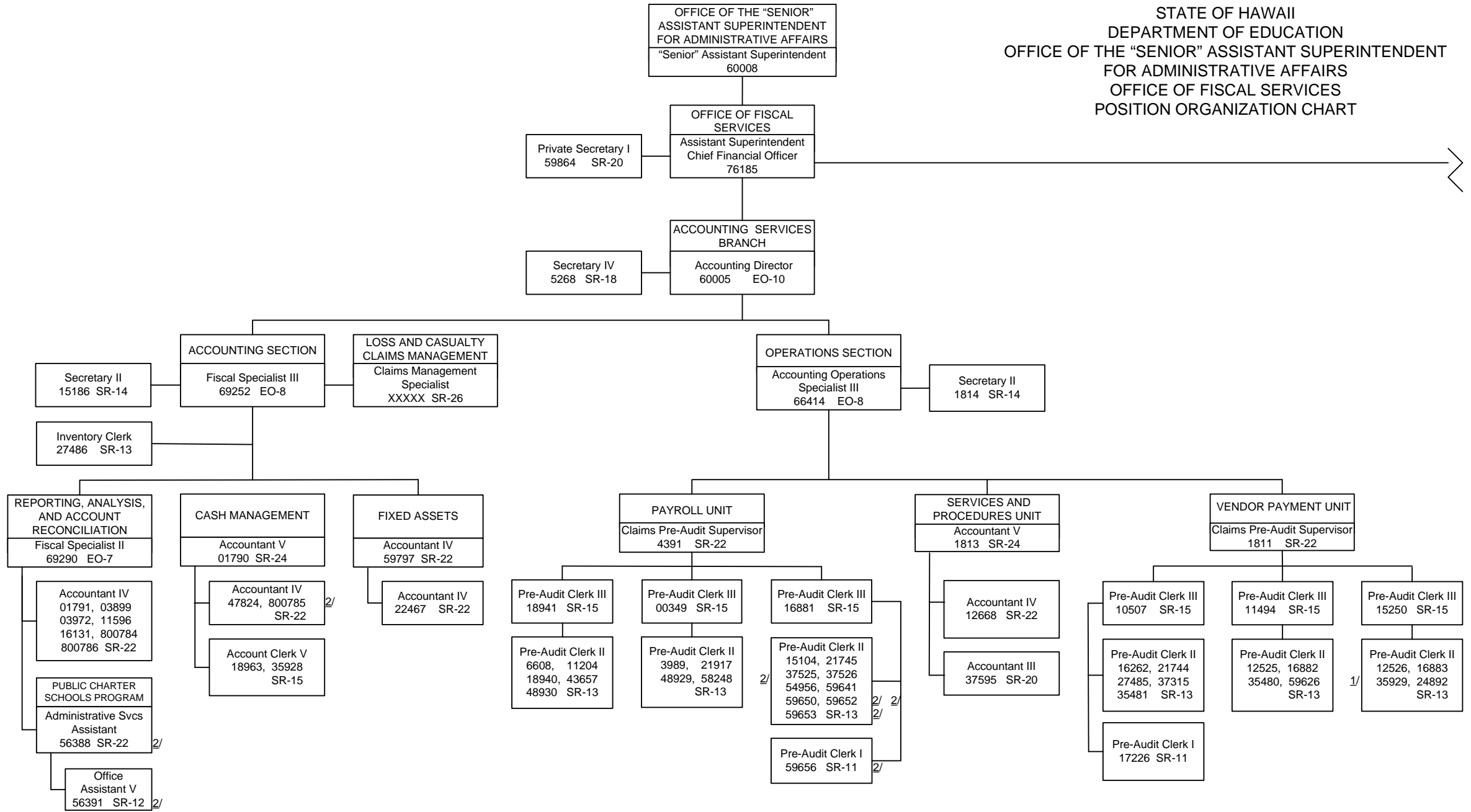

1/ Temporary position, General funds
2/ Temporary position, Federal funds

STATE OF HAWAII
DEPARTMENT OF EDUCATION
OFFICE OF THE "SENIOR" ASSISTANT SUPERINTENDENT
FOR ADMINISTRATIVE AFFAIRS
OFFICE OF FISCAL SERVICES
POSITION ORGANIZATION CHART

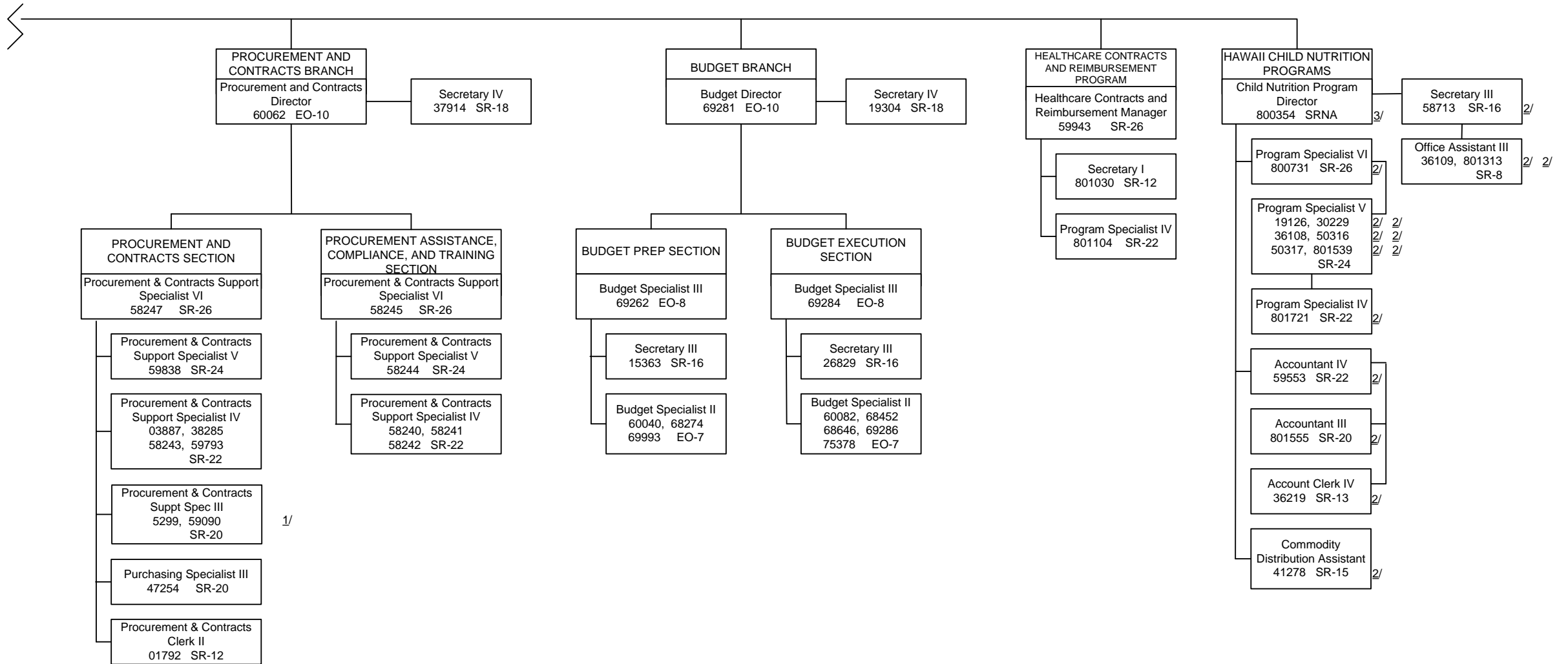

1/ On loan from Food Services; funded by Food Services

2/ Temporary position, Federal funds

3/ Temporary Exempt position, Federal funds

Department of Education
Organizational Chart

Table 24

STATE OF HAWAII
DEPARTMENT OF EDUCATION
OFFICE OF THE "SENIOR" ASSISTANT SUPERINTENDENT
FOR ADMINISTRATIVE AFFAIRS
OFFICE OF SCHOOL FACILITIES AND SUPPORT SERVICES
ORGANIZATION CHART

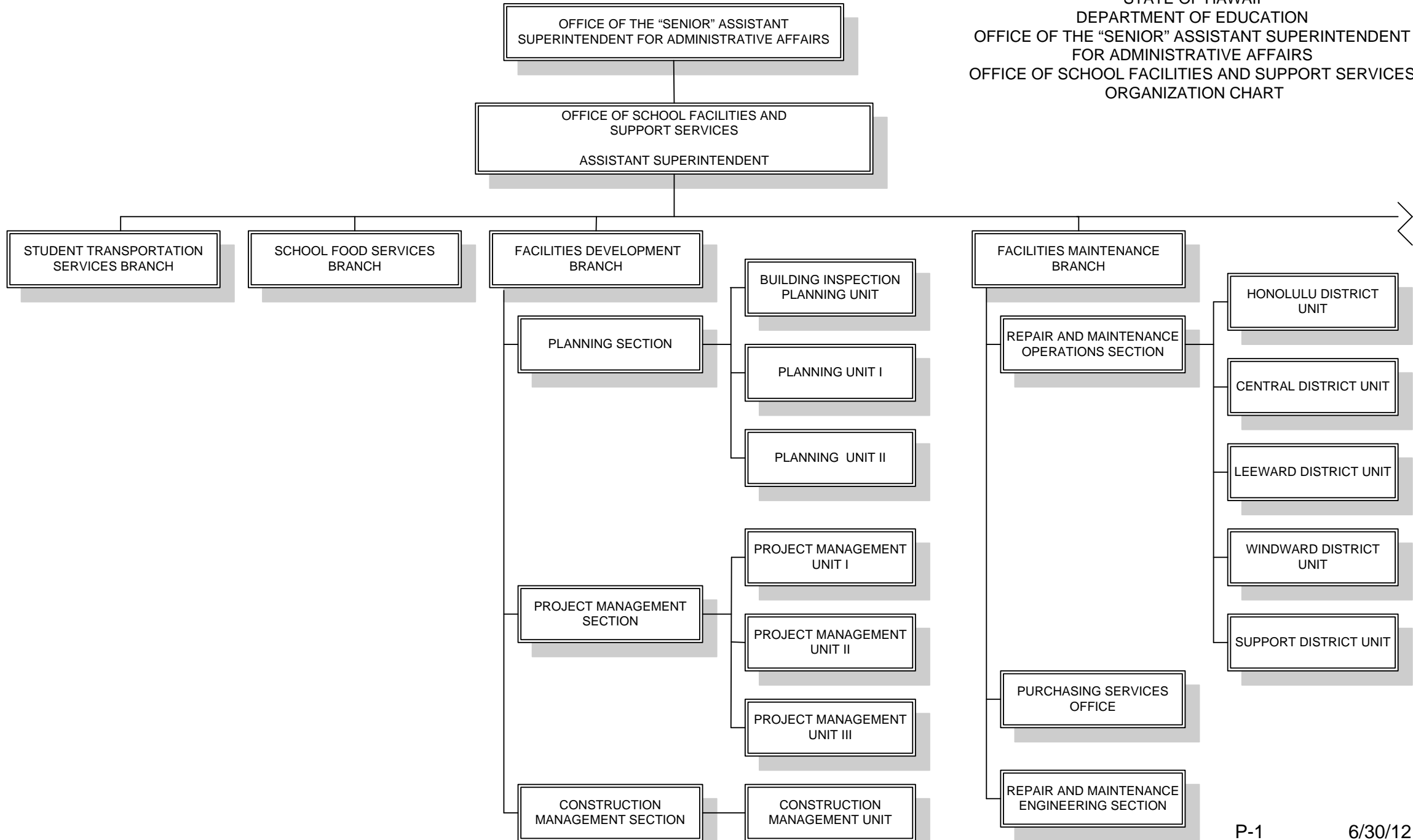

STATE OF HAWAII
DEPARTMENT OF EDUCATION
OFFICE OF THE "SENIOR" ASSISTANT SUPERINTENDENT
FOR ADMINISTRATIVE AFFAIRS
OFFICE OF SCHOOL FACILITIES AND SUPPORT SERVICES
ORGANIZATION CHART

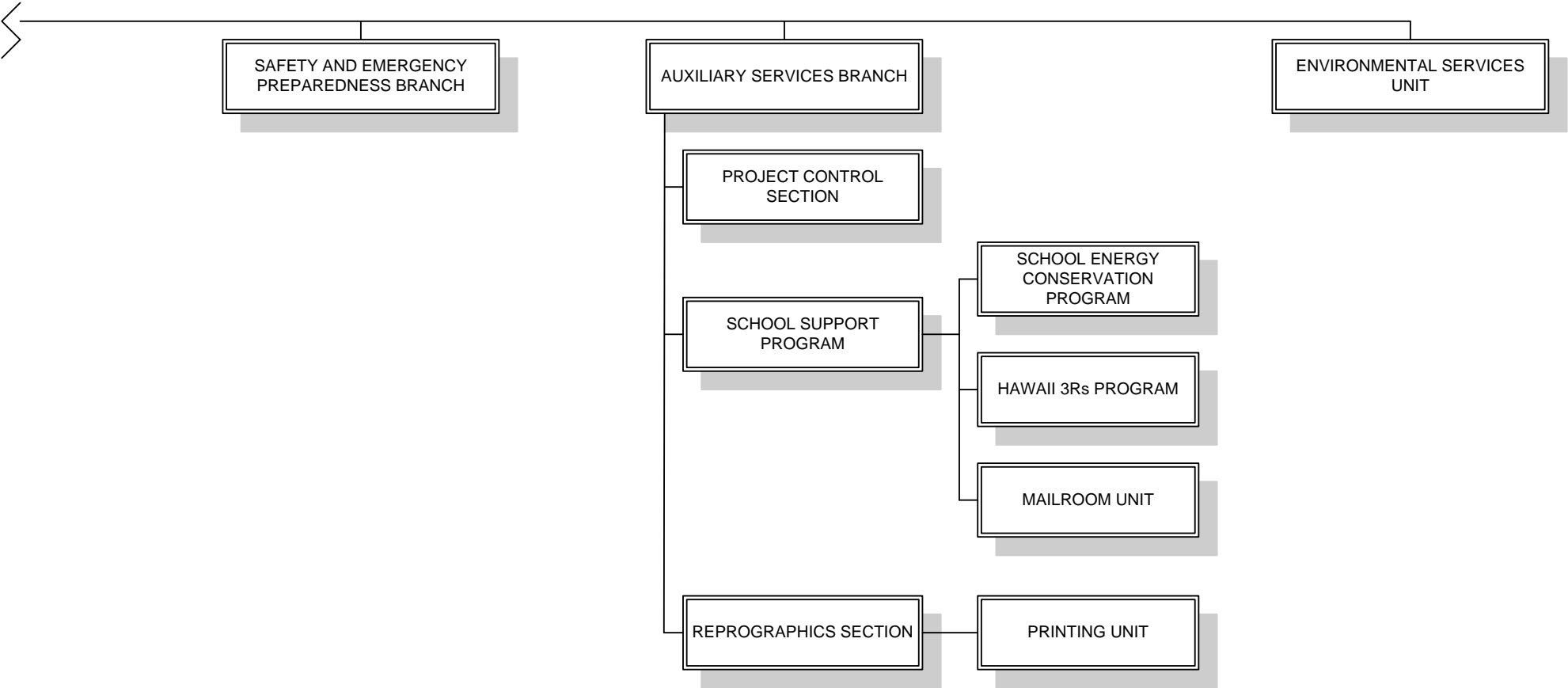

Department of Education
Organizational Chart

Table 24

STATE OF HAWAII
DEPARTMENT OF EDUCATION
OFFICE OF THE "SENIOR" ASSISTANT SUPERINTENDENT
FOR ADMINISTRATIVE AFFAIRS
OFFICE OF SCHOOL FACILITIES AND SUPPORT SERVICES
POSITION ORGANIZATION CHART

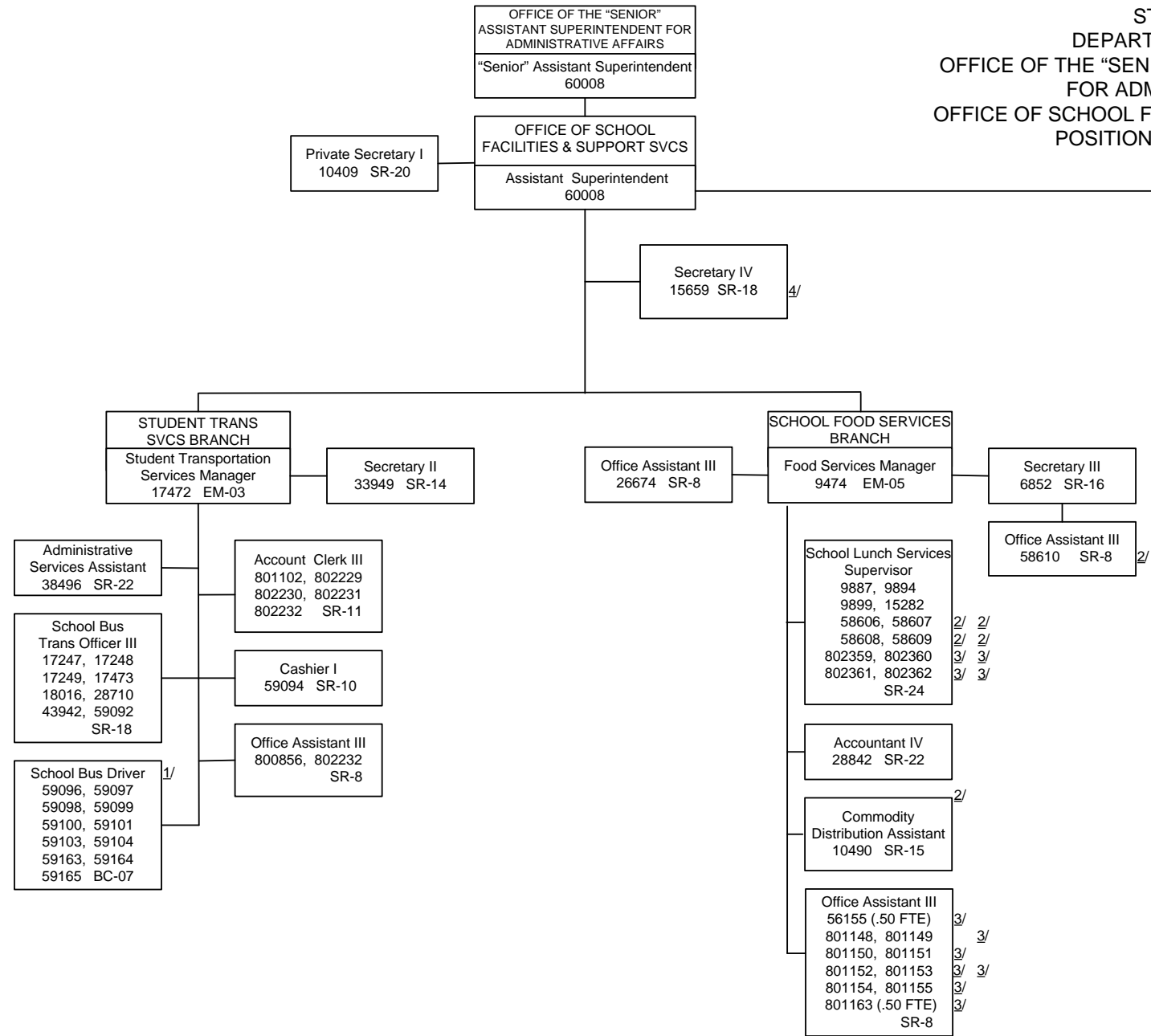

1/ All School Bus Driver positions are .50 FTE positions
2/ Permanent position, Special funds
3/ Temporary position, Special funds
4/ To be redescribed

STATE OF HAWAII
DEPARTMENT OF EDUCATION
OFFICE OF THE "SENIOR" ASSISTANT SUPERINTENDENT
FOR ADMINISTRATIVE AFFAIRS
OFFICE OF SCHOOL FACILITIES AND SUPPORT SERVICES
POSITION ORGANIZATION CHART

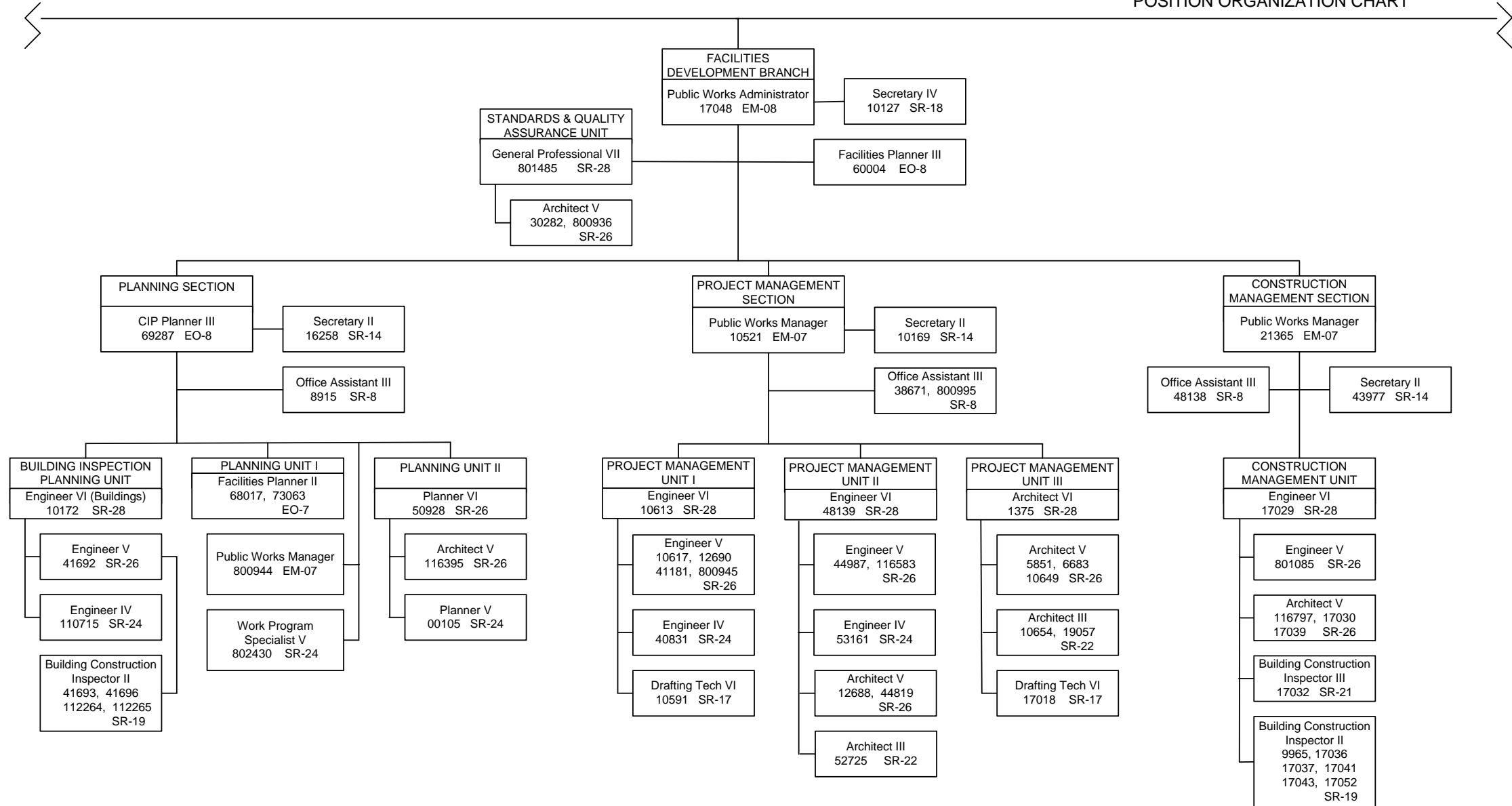

STATE OF HAWAII
DEPARTMENT OF EDUCATION
OFFICE OF THE "SENIOR" ASSISTANT SUPERINTENDENT
FOR ADMINISTRATIVE AFFAIRS
OFFICE OF SCHOOL FACILITIES AND SUPPORT SERVICES
POSITION ORGANIZATION CHART

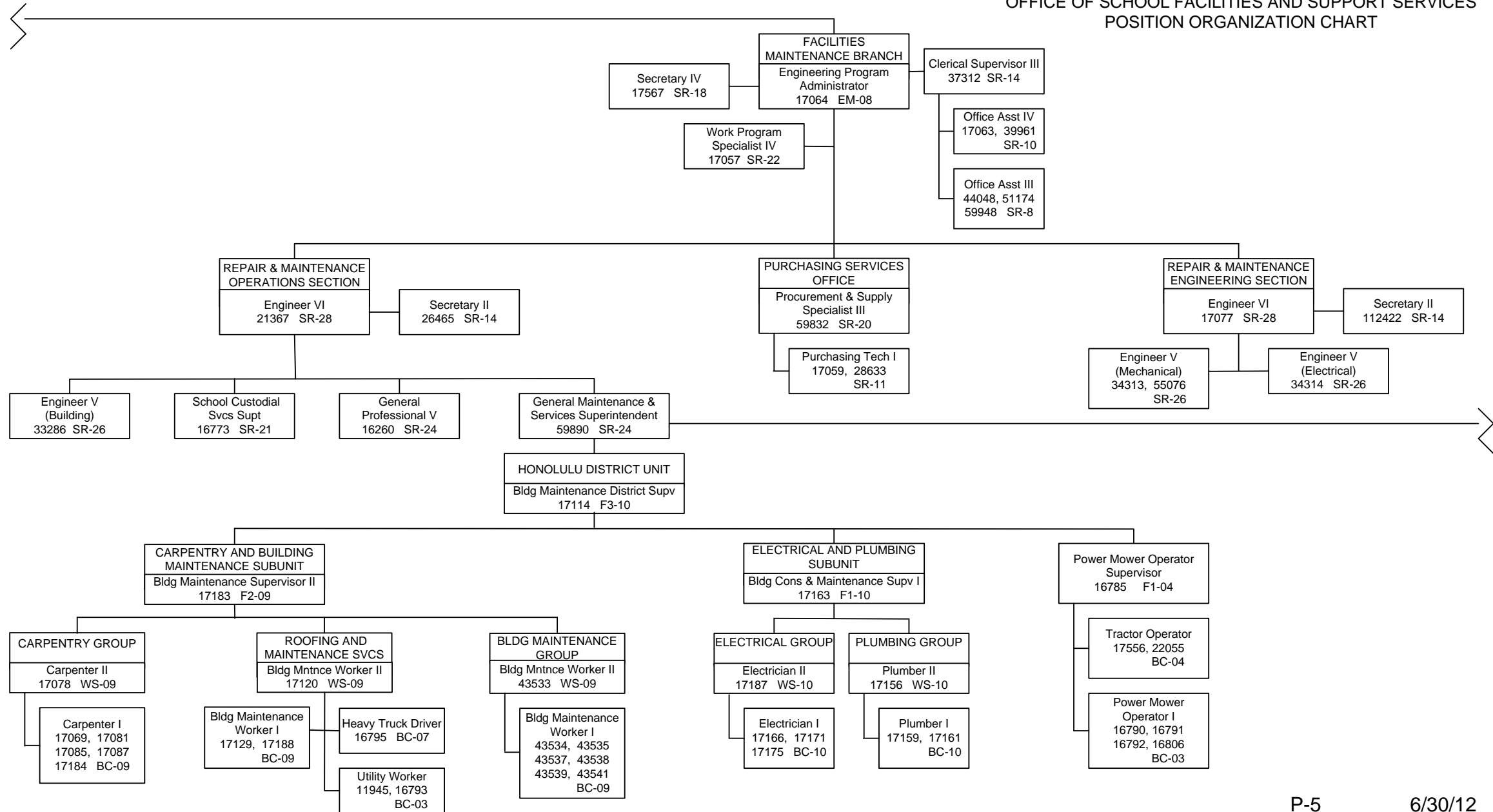

STATE OF HAWAII
DEPARTMENT OF EDUCATION
OFFICE OF THE "SENIOR" ASSISTANT SUPERINTENDENT
FOR ADMINISTRATIVE AFFAIRS
OFFICE OF SCHOOL FACILITIES AND SUPPORT SERVICES
POSITION ORGANIZATION CHART

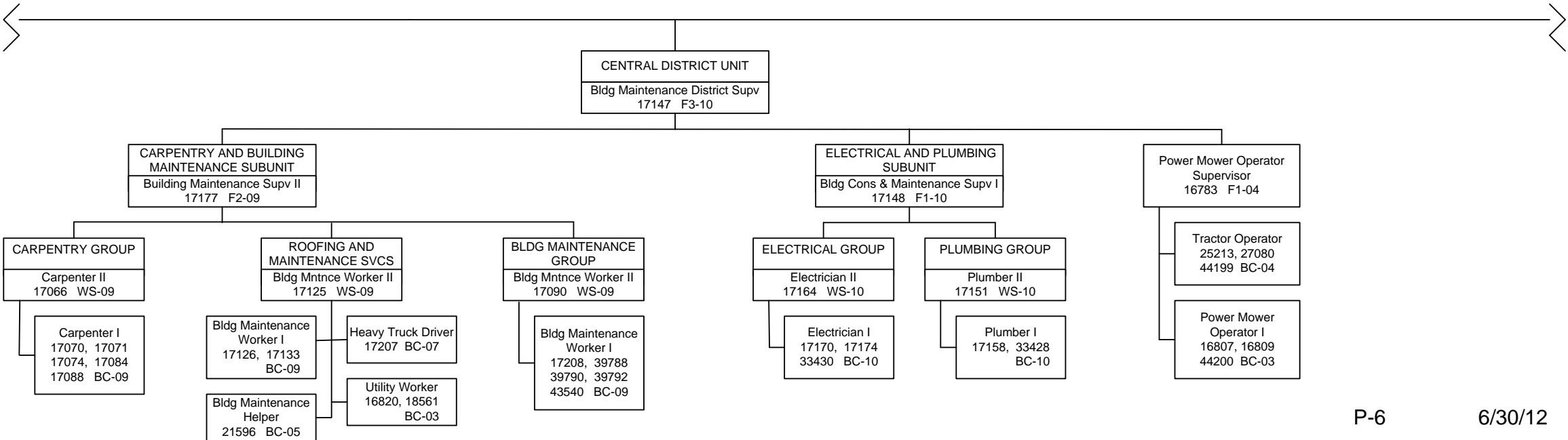

STATE OF HAWAII
DEPARTMENT OF EDUCATION
OFFICE OF THE "SENIOR" ASSISTANT SUPERINTENDENT
FOR ADMINISTRATIVE AFFAIRS
OFFICE OF SCHOOL FACILITIES AND SUPPORT SERVICES
POSITION ORGANIZATION CHART

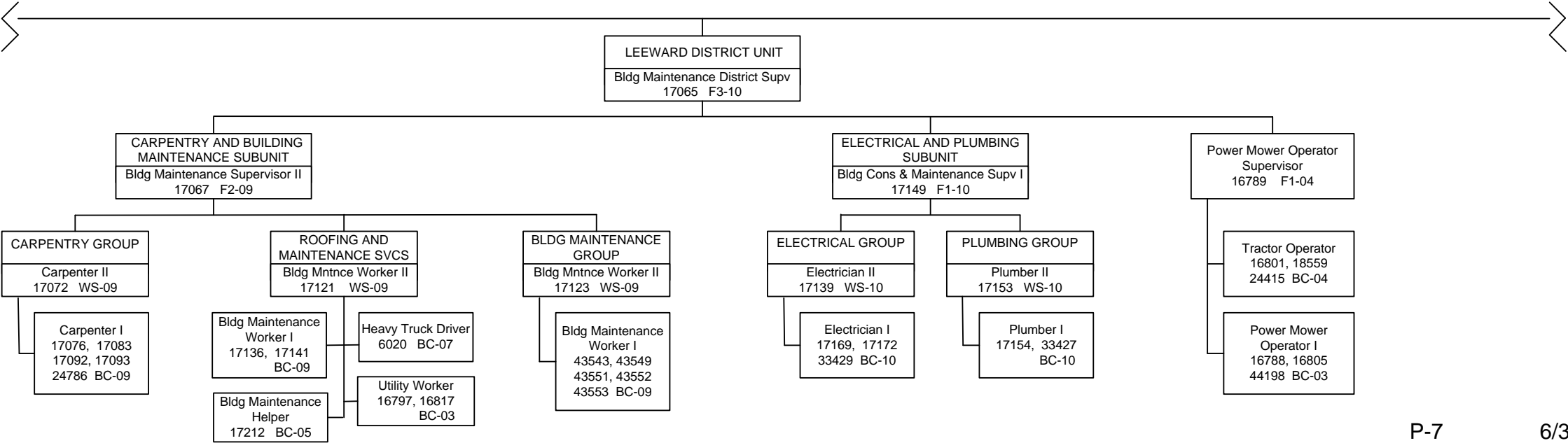

STATE OF HAWAII
DEPARTMENT OF EDUCATION
OFFICE OF THE "SENIOR" ASSISTANT SUPERINTENDENT
FOR ADMINISTRATIVE AFFAIRS
OFFICE OF SCHOOL FACILITIES AND SUPPORT SERVICES
POSITION ORGANIZATION CHART

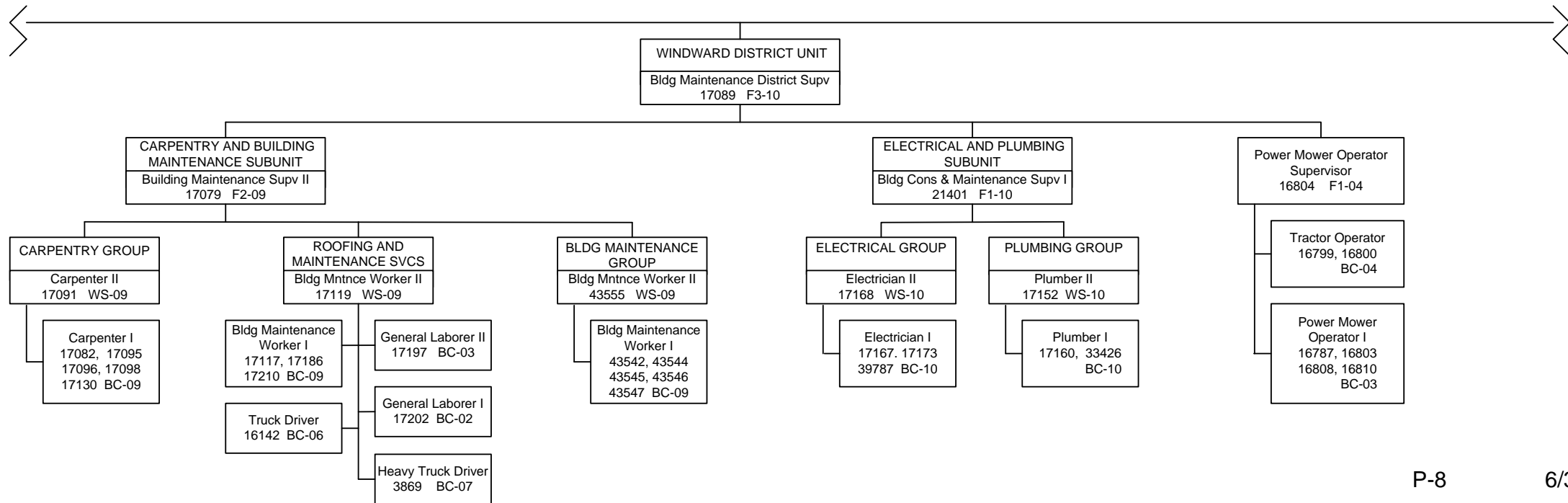

STATE OF HAWAII
DEPARTMENT OF EDUCATION
OFFICE OF THE "SENIOR" ASSISTANT SUPERINTENDENT
FOR ADMINISTRATIVE AFFAIRS
OFFICE OF SCHOOL FACILITIES AND SUPPORT SERVICES
POSITION ORGANIZATION CHART

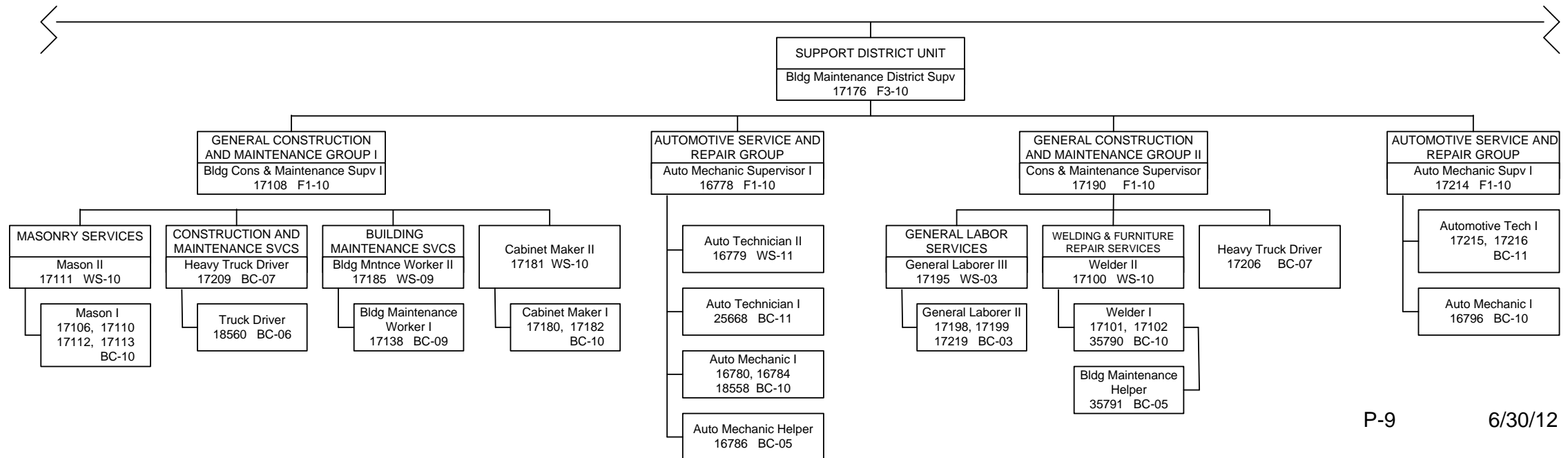

STATE OF HAWAII
DEPARTMENT OF EDUCATION
OFFICE OF THE "SENIOR" ASSISTANT SUPERINTENDENT
FOR ADMINISTRATIVE AFFAIRS
OFFICE OF SCHOOL FACILITIES AND SUPPORT SERVICES
POSITION ORGANIZATION CHART

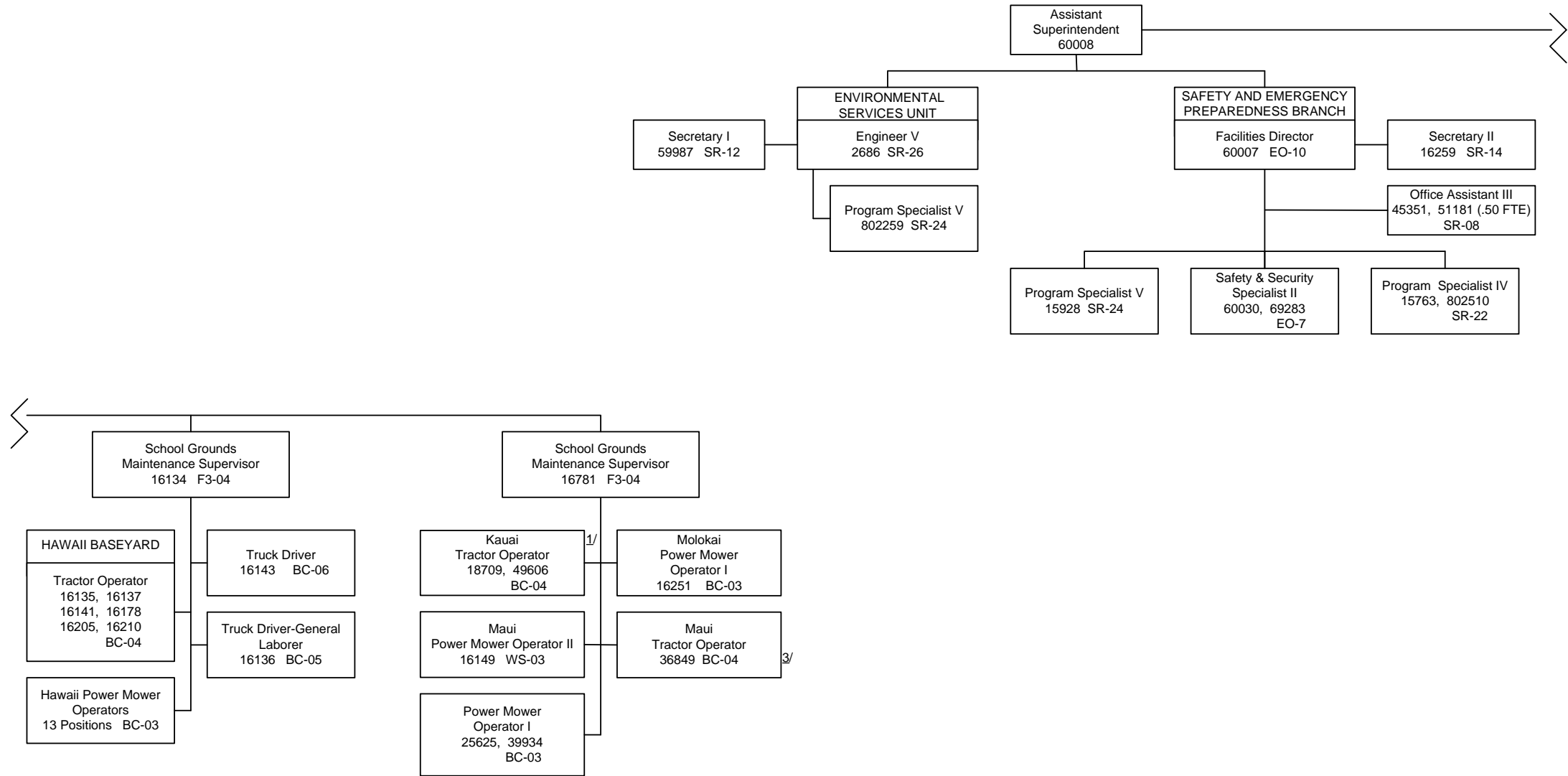

1/ Positions receive administrative supervision by Business Management Officer I – 800812 (Kapaa/Kauai/Waimea Complex Area)

2/ Temporary position, Federal funds; position receives technical supervision from Safety & Security Spec II, position no. 60030

3/ Temporary position, General funds

STATE OF HAWAII
DEPARTMENT OF EDUCATION
OFFICE OF THE "SENIOR" ASSISTANT SUPERINTENDENT
FOR ADMINISTRATIVE AFFAIRS
OFFICE OF SCHOOL FACILITIES AND SUPPORT SERVICES
POSITION ORGANIZATION CHART

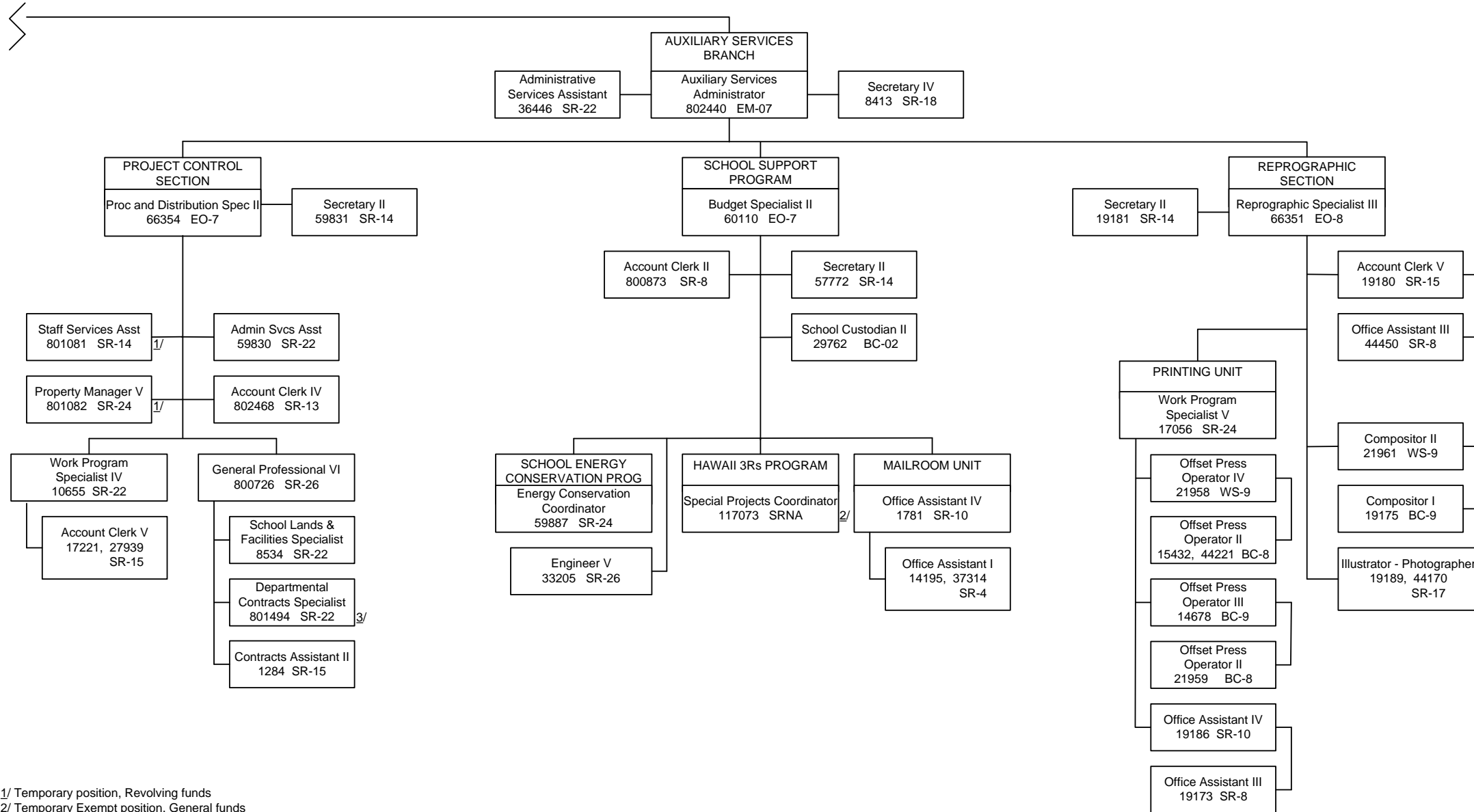

1/ Temporary position, Revolving funds
2/ Temporary Exempt position, General funds
3/ Temporary position, Special funds

Department of Education
Organizational Chart

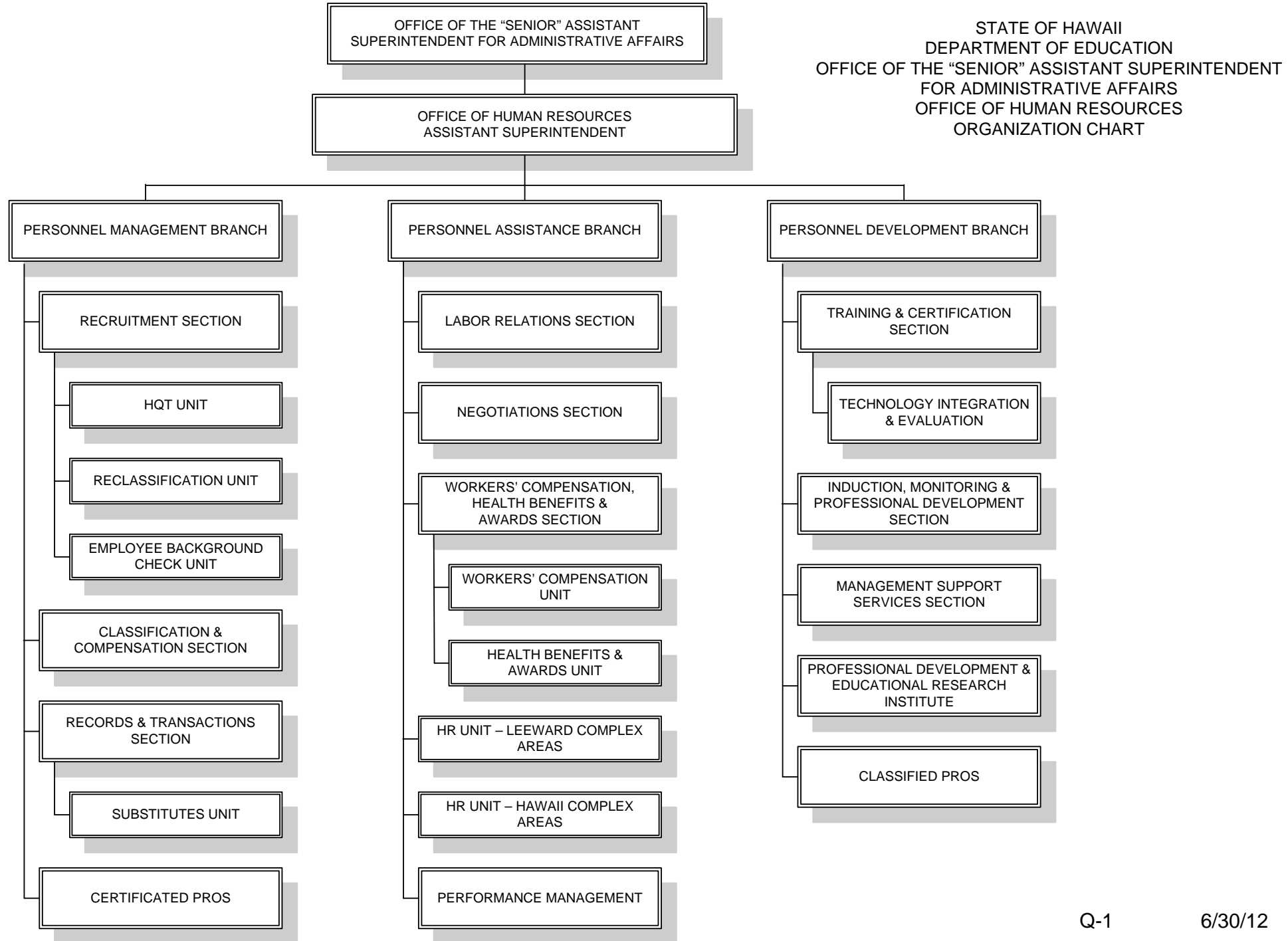

STATE OF HAWAII
DEPARTMENT OF EDUCATION
OFFICE OF THE "SENIOR" ASSISTANT SUPERINTENDENT
FOR ADMINISTRATIVE AFFAIRS
OFFICE OF HUMAN RESOURCES
ORGANIZATION CHART

Department of Education
Organizational Chart

Table 24

STATE OF HAWAII
DEPARTMENT OF EDUCATION
OFFICE OF THE "SENIOR" ASSISTANT SUPERINTENDENT
FOR ADMINISTRATIVE AFFAIRS
OFFICE OF HUMAN RESOURCES
POSITION ORGANIZATION CHART

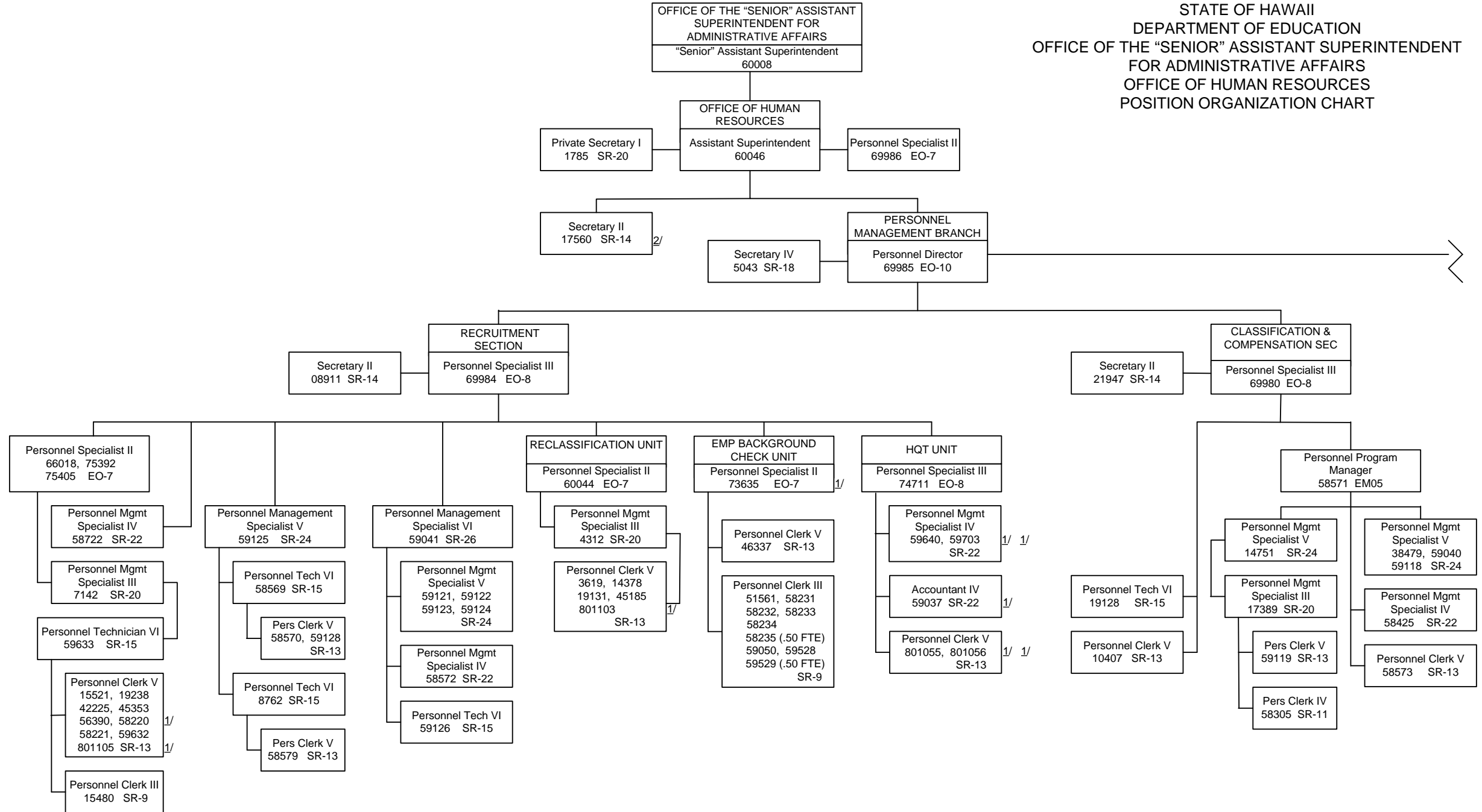

1/ Temporary position, Federal funds
2/ To be redescribed

STATE OF HAWAII
DEPARTMENT OF EDUCATION
OFFICE OF THE "SENIOR" ASSISTANT SUPERINTENDENT
FOR ADMINISTRATIVE AFFAIRS
OFFICE OF HUMAN RESOURCES
POSITION ORGANIZATION CHART

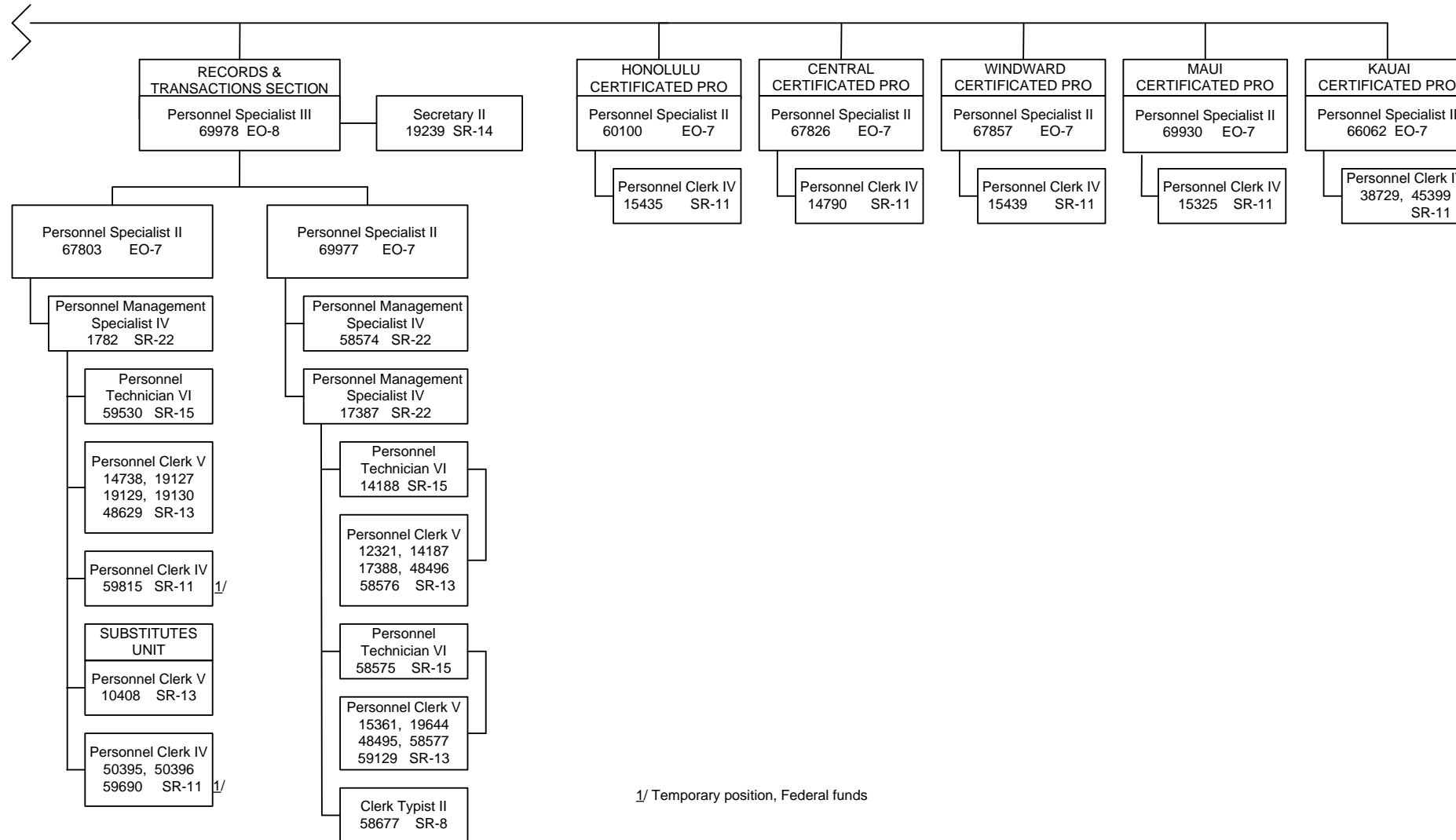

1/ Temporary position, Federal funds

STATE OF HAWAII
DEPARTMENT OF EDUCATION
OFFICE OF THE "SENIOR" ASSISTANT SUPERINTENDENT
FOR ADMINISTRATIVE AFFAIRS
OFFICE OF HUMAN RESOURCES
POSITION ORGANIZATION CHART

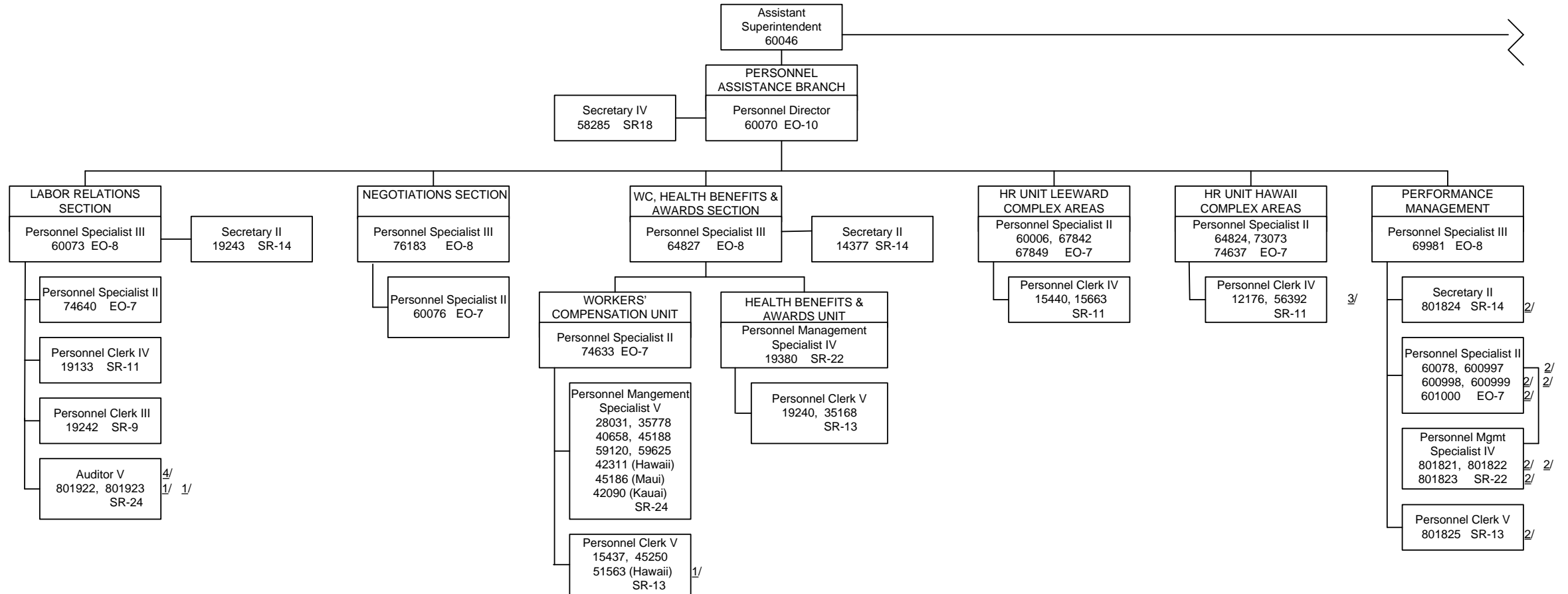

1/ Temporary position, General funds
2/ Temporary position, Federal funds
3/ Position is on loan from Hawaii District Office
4/ To be redescribed

STATE OF HAWAII
DEPARTMENT OF EDUCATION
OFFICE OF THE "SENIOR" ASSISTANT SUPERINTENDENT
FOR ADMINISTRATIVE AFFAIRS
OFFICE OF HUMAN RESOURCES
POSITION ORGANIZATION CHART

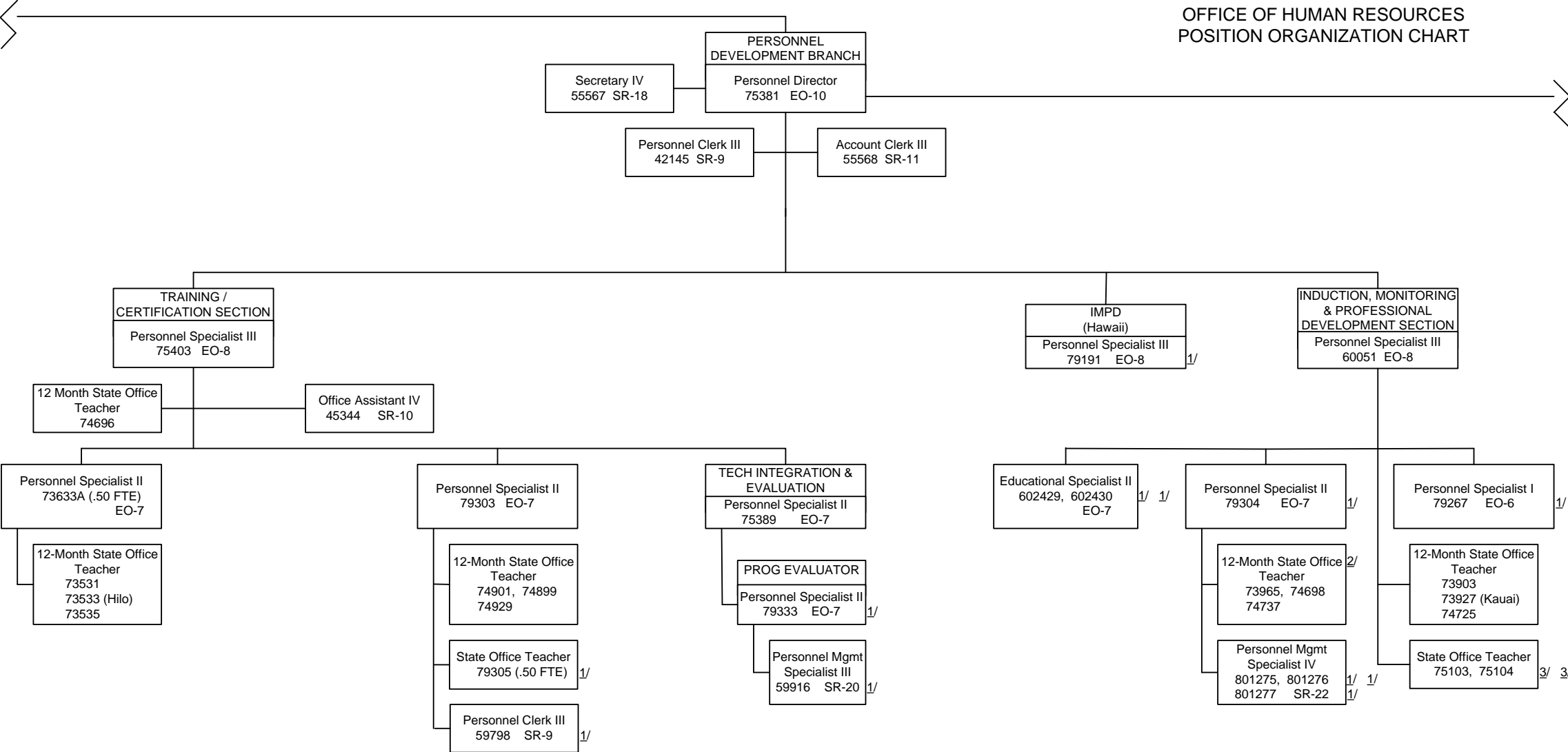

1/ Temporary position, Federal funds
2/ Positions receive technical supervision from Personnel Specialist II, position no. 74711
3/ Temporary position, Trust funds

STATE OF HAWAII
DEPARTMENT OF EDUCATION
OFFICE OF THE "SENIOR" ASSISTANT SUPERINTENDENT
FOR ADMINISTRATIVE AFFAIRS
OFFICE OF HUMAN RESOURCES
POSITION ORGANIZATION CHART

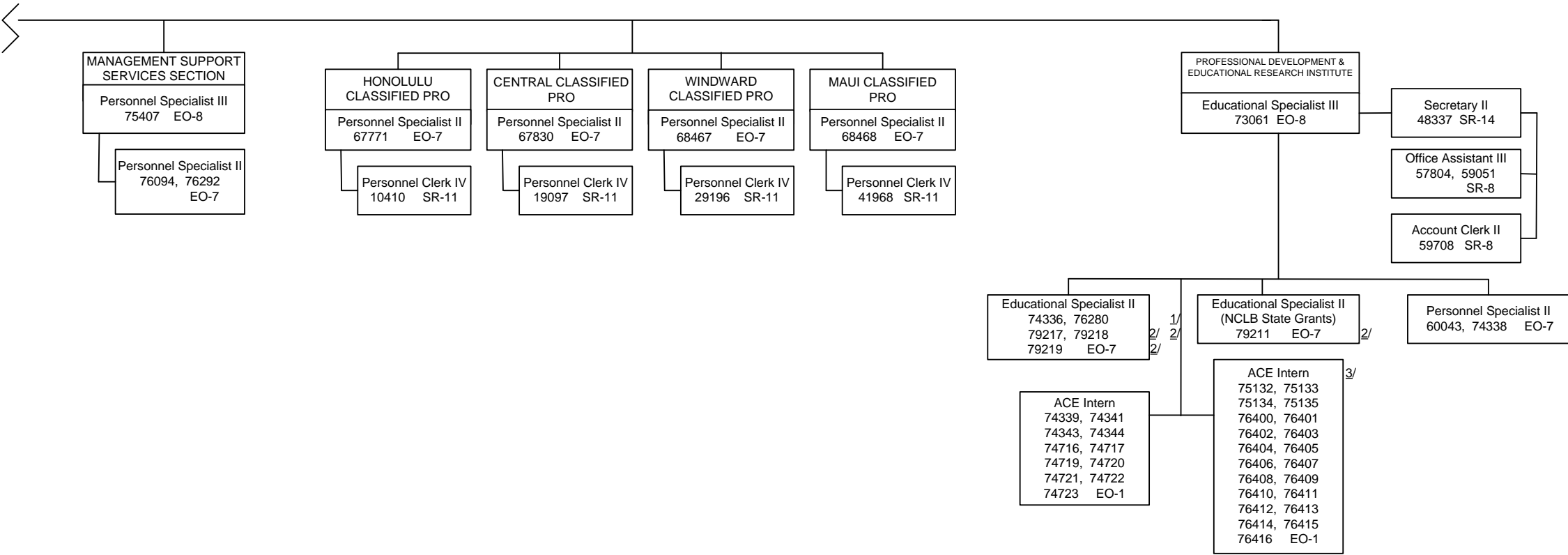

1/ Temporary position, General funds
2/ Temporary position, Federal funds
3/ Temporary ACE Intern positions, General funds

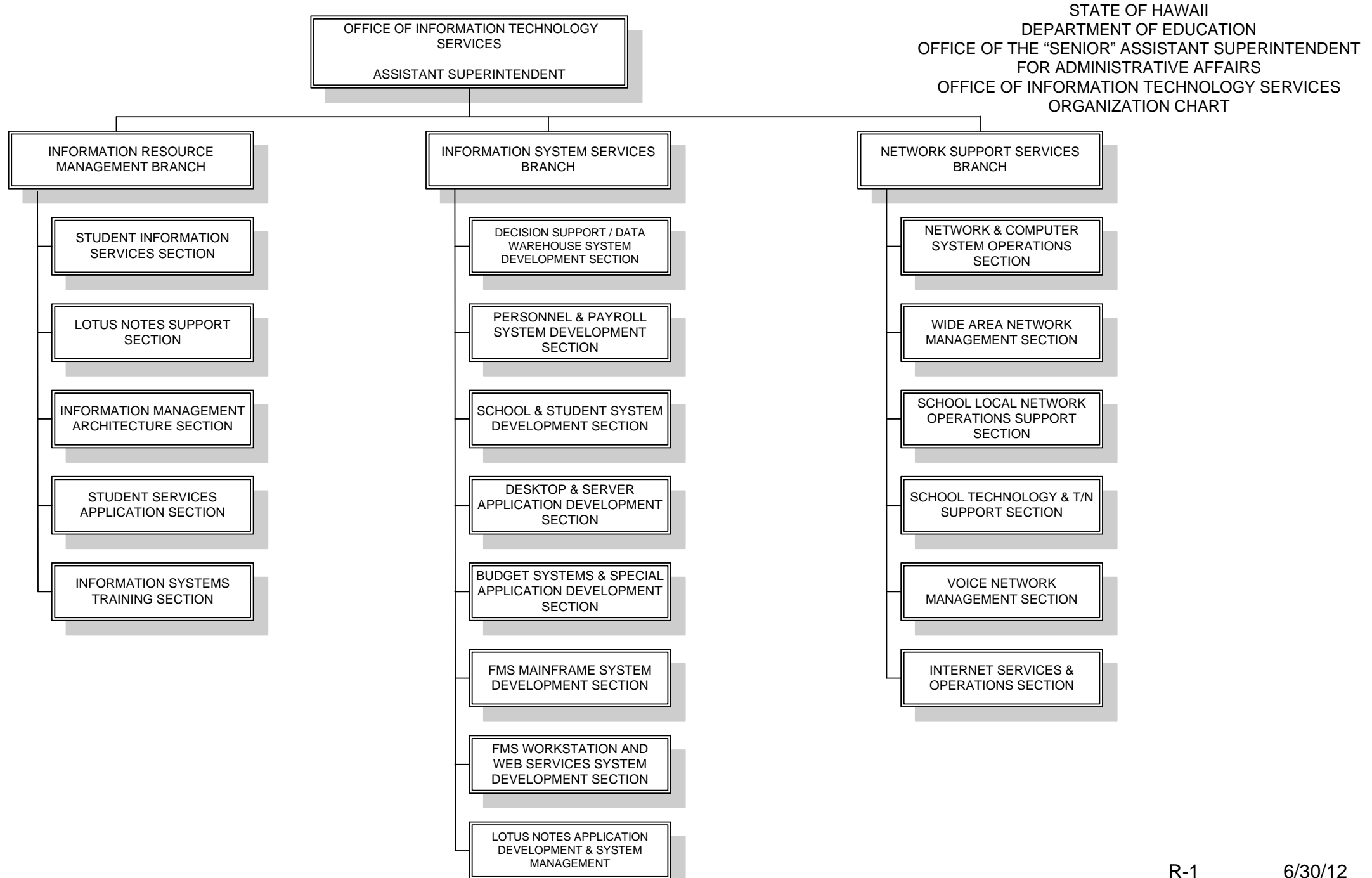

STATE OF HAWAII
DEPARTMENT OF EDUCATION
OFFICE OF THE "SENIOR" ASSISTANT SUPERINTENDENT
FOR ADMINISTRATIVE AFFAIRS
OFFICE OF INFORMATION TECHNOLOGY SERVICES
POSITION ORGANIZATION CHART

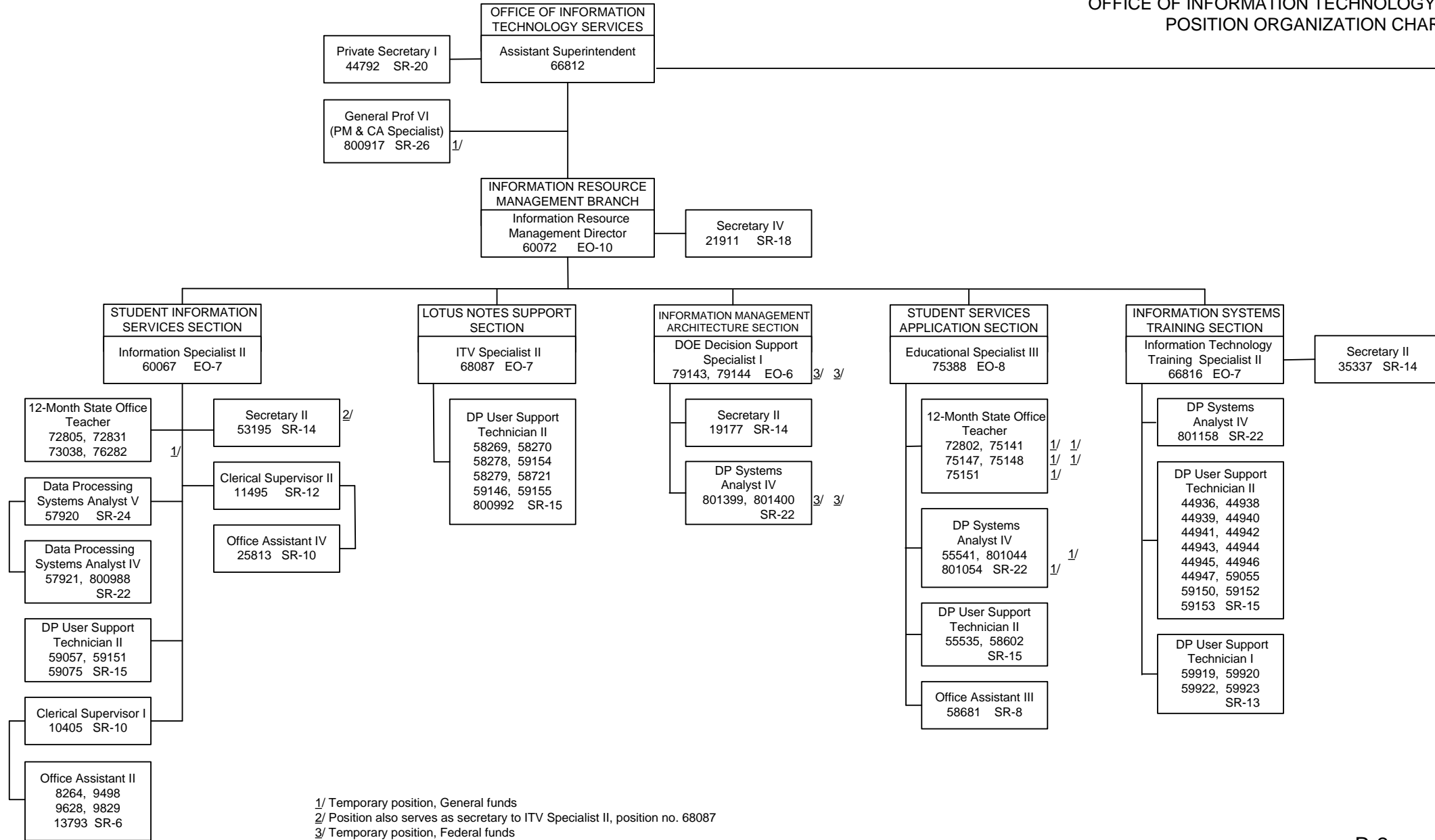

1/ Temporary position, General funds
2/ Position also serves as secretary to ITV Specialist II, position no. 68087
3/ Temporary position, Federal funds

Department of Education
Organizational Chart

Table 24

STATE OF HAWAII
DEPARTMENT OF EDUCATION
OFFICE OF INFORMATION TECHNOLOGY SERVICES
POSITION ORGANIZATION CHART

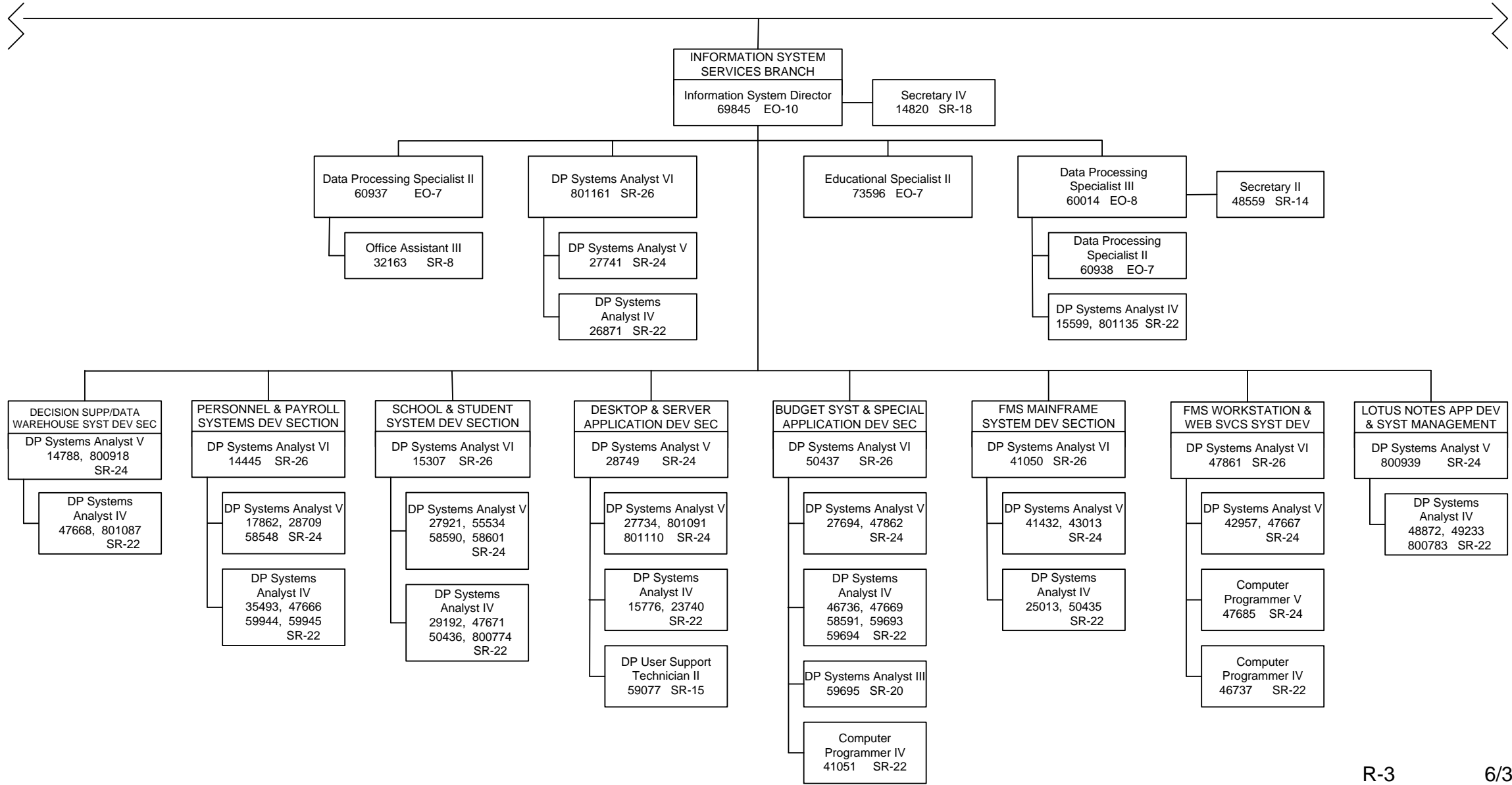

STATE OF HAWAII
DEPARTMENT OF EDUCATION
OFFICE OF INFORMATION TECHNOLOGY SERVICES
POSITION ORGANIZATION CHART

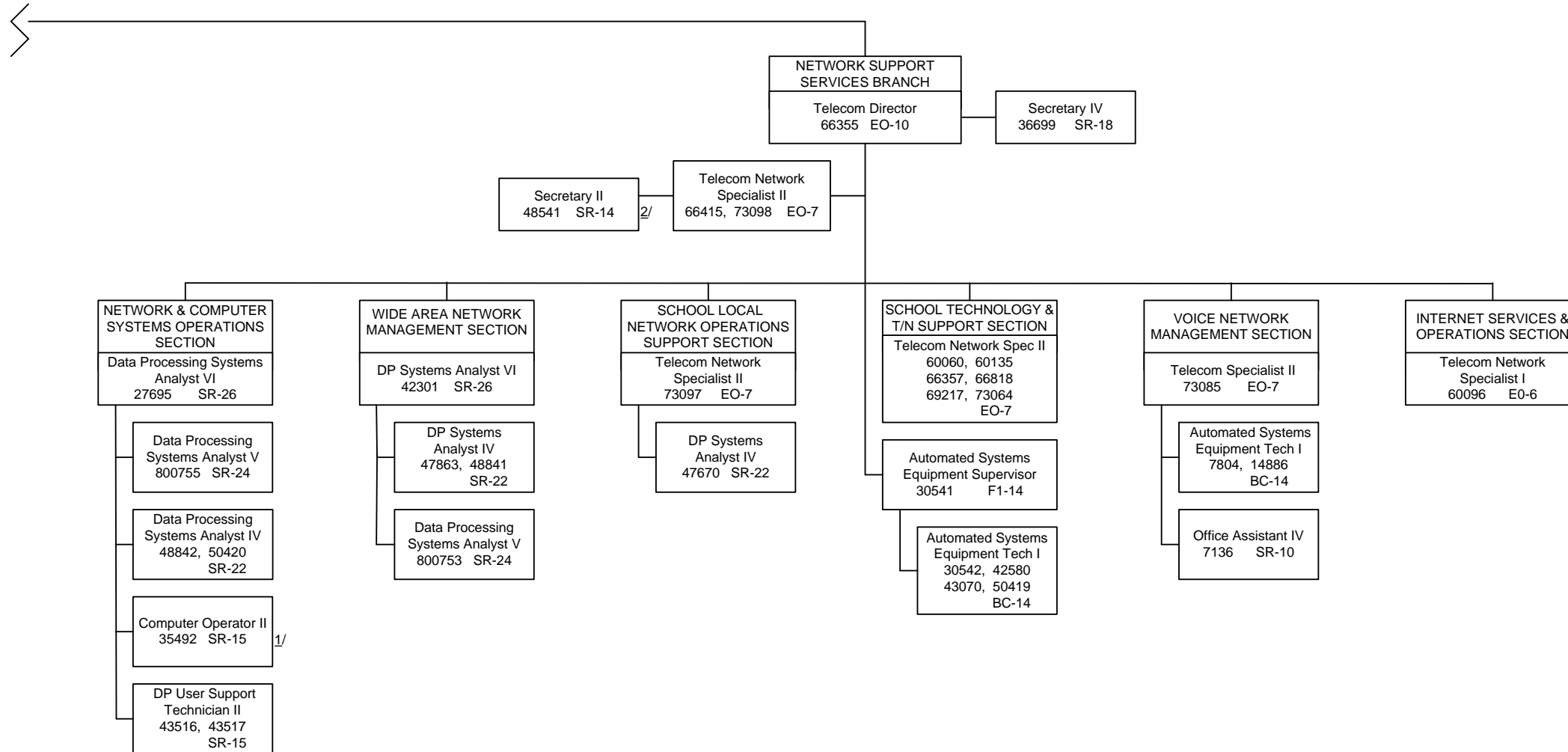

1/ Temporary position, General funds

2/ Secretary II, position no. 48541 receives technical supervision from Telecommunications Network Specialist II, position no. 66415

STATE OF HAWAII
DEPARTMENT OF EDUCATION
OFFICE OF THE "SENIOR" ASSISTANT SUPERINTENDENT
FOR ADMINISTRATIVE AFFAIRS
STANDARD PRACTICES
ORGANIZATION CHART

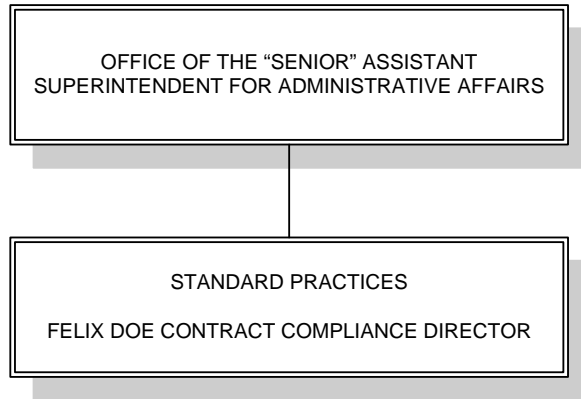

STATE OF HAWAII
DEPARTMENT OF EDUCATION
OFFICE OF THE "SENIOR" ASSISTANT SUPERINTENDENT
FOR ADMINISTRATIVE AFFAIRS
STANDARD PRACTICES
POSITION ORGANIZATION CHART

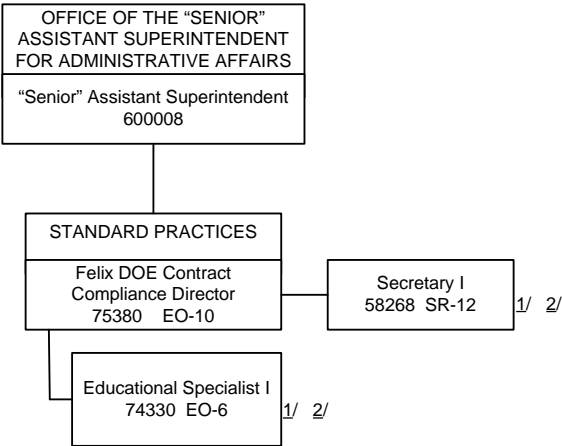

1/ Temporary position, General funds
2/ To be redescribed

DEPARTMENT OF EDUCATION

FUNCTIONAL STATEMENT

The Department of Education (DOE) is a department in the executive branch of the state government. The department manages the statewide systems of public schools and public libraries. The legislative appropriations of state general funds and special funds, and federal funds and grants received to support public school and public library programs, are administered by the DOE on a statewide basis and subject to executive branch expenditure restrictions.

As provided by law, the DOE is subject to executive branch policies and controls relating to state education functional planning, financial administration, administrative rulemaking, collective bargaining negotiations, and acquisition and disposition of school land.

The DOE is also dependent on other executive branch agencies which function as state central service agencies for certain systems support services, such as legal services (Department of the Attorney General), main frame computers (Department of Accounting and General Services), and school employee housing (Department of Human Services – Hawaii Public Housing Authority).

The head of the DOE is the Board of Education (BOE). The BOE is a policy-making board consisting of 9 members appointed by the Governor with the advice and consent of the Senate, and a public high school student who is selected by the Hawaii State Student Council and serves as a non-voting member, and a military representative who is appointed by the senior military commander in Hawaii and serves as a non-voting member.

Public School System

The Superintendent of Education is assisted by a Deputy Superintendent managing the academic/educational programs and the “Senior” Assistant Superintendent supervising and directing the administrative offices.

Public schools are under the field supervision of 15 regional administrative units called Complex Areas, each supervised by a complex area superintendent who reports directly to the Deputy Superintendent. A Complex Area consists of one or more school complexes, each school complex consisting of a high school and its feeder middle and elementary schools. Complex Learning Support Centers are established to provide shared instructional and student support services to each school. The schools of each complex collaboratively manage their Complex Learning Support Center.

The scope of educational programs and services of the public schools regularly encompasses grades kindergarten through 12 (K-12), and such pre-school programs and community/adult education programs as may be established by law. In addition to regular programs of instruction and support services, public schools offer special programs and services for qualified students with disability, gifted and talented students, students with limited English language proficiency, and students who are economically and culturally disadvantaged, school-alienated, or instructionally confined.

Other public education service programs administered by the public school system include regulation of private trade, vocational, and technical schools; public summer schools; Western Association for Schools and Colleges (WASC) accreditation program for public secondary and adult education schools, and private secondary schools in Hawaii; the A+ Program for after-school care of

“latchkey” children; and various programs and services funded by the federal government, trusts, and private agencies that may benefit eligible persons in the general public as well as public school students.

Public Library System

The public library system is administered by the State Librarian. The public library system operated the Hawaii State Library, the Library for the Blind and Physically Handicapped, public libraries, community public and school libraries, and bookmobile services.

Special library services, including interlibrary loans, federal documents depository and inter-agency (municipal, state, and federal) exchange, are provided by the Hawaii State Library. The Library for the Blind and Physically Handicapped provides transcribing services to the blind; produces, maintains, and makes available specialized collections and services to the blind and physically handicapped; and assists state-supported residential, medical, educational, and correctional institutions in their library development and operations. Materials selection, ordering, cataloging, preparation, and binder services for all libraries are centrally administered.

Agencies Attached to the Department of Education

The following agencies are attached to the Department of Education for administrative purposes only:

- Classification/Compensation Appeals Board (as established by Section 302A-620, Hawaii Revised Statutes): Serves as an appellate body on matters of educational officer classification and compensation; adopts policies and standards relative to classification and compensation for education officers; and adopts rules pursuant to Chapter 91, HRS, *Administrative Procedure*, for the conduct of appeal hearings.
- Hawaii Teacher Standards Board (as established by Section 302A-801 to 803, HRS): Establishes standards for the issuance of public school teacher licenses and credentials; adopts policies and standards, including fees, for teacher licensing and credentialing; and adopts rules pursuant to Chapter 91, HRS.
- Charter School Review Panel (as established by Section 302B-3, HRS): Appoints and evaluates the executive director [of the Charter School Administrative Office] and approves staff and salary levels for the Charter School Administrative Office; reviews, approves, or denies charter applications for new charter schools; reviews, approves, or denies significant amendments to detailed implementation plans to maximize the charter school’s financial and academic success, long-term organizational viability, and accountability; adopts reporting requirements for charter schools; reviews annual self-evaluation reports from charter schools and takes appropriate action; periodically adopt improvements in the panel’s monitoring and oversight of charter schools; and periodically adopt improvements in the Charter School Administrative Office’s support of charter schools and management of the charter school system.
- Charter School Administrative Office (as established by Section 302B-8, HRS): Serves as the conduit to disseminate communications from the Charter School Review Panel, BOE, and DOE to all charter schools; provides advocacy, assistance, and support for the development, growth, progress, and success of charter schools and the charter school system; provides independent analyses and recommendations on charter school

issues; and is responsible for the internal organization, operation, and management of the charter school system, including the preparation and execution of budgets, allocating annual appropriations and distributing federal funds, complying with applicable state laws related to the administration of charter schools, and preparing contracts between charter schools and the DOE and other state departments.

Early Learning Council (as established by Section 302L-3, HRS) is established and attached to the Department of Education for administrative purposes only, notwithstanding any other law to the contrary. To the extent permissible by law, the Council shall develop and administer the early learning system established in section 302L-2 to benefit all children throughout the State, from birth until the time they enter kindergarten.

DEPARTMENT OF EDUCATION

BOARD OF EDUCATION

FUNCTIONAL STATEMENT

The Board of Education (Board) heads the Department of Education, as provided by Section 26-12, Hawaii Revised Statutes (HRS).

The Board in accordance with applicable laws and its By-Laws, formulates statewide educational policy, adopts student performance standards and assessment models, monitors school success, and appoints the Superintendent of Education as the chief executive officer of the public school system, as provided by law (Article X, Section 3 of the Constitution of the State of Hawaii, and Section 302A-1101, HRS).

The Board formulates policy and appoints the State Librarian as the chief executive officer of the public library system, as provided by law (Section 312-2, HRS).

The Board, through the State Librarian, has direct control of the public library system, excluding school libraries (Section 302A-1120, HRS).

The Board appoints the members of the Charter School Review Panel, which serves as the charter authorizer for charter schools, with the power and duty to issue charters, oversee and monitor charter schools, hold charter schools accountable for their performance, and revoke charters.

DEPARTMENT OF EDUCATION
OFFICE OF THE SUPERINTENDENT
FUNCTIONAL STATEMENT

OFFICE OF THE SUPERINTENDENT OF EDUCATION

The Superintendent of Education is responsible for efficiently and effectively administering the public school system in accordance with law and educational policies adopted by the Board of Education.

- Executes Board policies.
- Recommends to the Board the public school system's program goals, objectives and plans, performance standards, capital improvement plans, and budgets.
- Develops and establishes with the approval of the Board a comprehensive accountability and assessment program for the public school system.
- Presents concise reports periodically at board meetings covering, but not limited to, the following:
 - Public school system's goals, objectives, plans and progress toward them.
 - Major program developments.
 - Enrollment developments and projections.
 - Personnel developments.
 - Budget status, current fiscal year and plans for the next fiscal year.
 - Major accomplishments and problems.
 - Outlook for the future.
- Assists the Board chairperson and the respective Board of Education committee chairpersons in strengthening the roles of Board of Education committees.
- Provides administrative leadership in collective bargaining and maintenance of relationships with professional organizations and unions.
- Provides administrative support to the Board of Education, committees, advisory councils and commissions.
- Maintains liaison on behalf of the Board of Education with the State Legislature, governor, the various state departments and the people of the State of Hawaii on matters pertaining to the administration of the public school system.
- Presents for Board approval nominations and appointments of all assistant and complex area superintendents.

- Promotes partnerships between the public school system and various sectors of the community: business, trusts and foundations, and other government agencies.

The following offices report directly to the Superintendent of Education:

1. ADMINISTRATIVE ASSISTANT

The administrative assistant to the Superintendent of Education provides staff support to the Superintendent of Education by coordinating the department's response to requests for administrative information and action from the Board of Education, legislature, other Executive Branch agencies, officials from other state and federal educational agencies, interest groups and the general public.

- Maintains control of all incoming and outgoing executive communications and records management for the Office of the Superintendent.
- Assists the Superintendent of Education in proposing agenda items for Board of Education meetings; assures timely availability of staff reports, study materials and resource persons from appropriate staff offices; and coordinates follow-up staff action on Board requests made to the Superintendent of Education.
- Serves as the superintendent's liaison with the legislature, as directed; coordinates DOE staff work in response to legislative requests for information, legislative reporting, drafting and seeking introduction of legislation, monitoring the status of pending legislation, and preparing testimony and monitoring committee hearings on proposed legislation.
- Assists the Superintendent of Education in coordinating the department's participation in administrative programs and activities of the Executive Branch including coordination of legal issues and lawsuits.
- Advises and assists the Superintendent of Education in complying with state protocol and fulfilling obligations as a public officer in dealing with individuals and organizations representing local, national, and international interests in public education.
- Provides other personalized administrative assistance to enable the Superintendent of Education to carry out duties and responsibilities as the Board of Education's executive officer for the public school system.
- Coordinates special projects in which other agencies or private organizations are involved, as assigned by the superintendent.

2. SYSTEMS ACCOUNTABILITY OFFICE

The Systems Accountability Office oversees the development and administration of the student assessment, school evaluation, and system evaluation components of the department's accountability system. The office also provides support related to departmental planning and analysis, evaluation, and student testing to the superintendent, Board of Education, and schools; governor and other executive agencies; legislature; and general public.

System Planning and Improvement Section

- Formulates state educational plans that set directions, present strategies, and provide timelines for accomplishment and array costs.

- Develops planning strategies that integrate varied and sometimes competing needs of the department.
- Performs analyses of policies and issues that have system wide impact and recommends solutions to resolve problems.
- Performs analyses to systematically review programs in the department's operating budget.
- Acts as liaison to other federal and state agencies on system wide planning and analytical activities pertaining to the public school system.
- Supervises and coordinates the work of community and/or stakeholder task forces created to provide varied input to projects and resolves sometimes conflicting input from task force members.
- Participates in the work of project teams, which often are comprised of personnel from within the office, as well as other organizational units within the department.
- Drafts testimonies, bills, and resolutions, and provides other technical assistance and support throughout the legislative process on behalf of the Department of Education.
- Identifies issues related to program implementation, program development, and program improvement.
- Ensures that the resolution of those issues is fully communicated within and outside the department.
- Performs other related activities, as assigned by the office director and superintendent.

System Evaluation and Reporting Section

- Assists with the coordination of, and support for, the statewide assessment and accountability system; develops and implements components related to school and system evaluation; conducts research and development work on educational indicators and analyses; and prepares evaluations reports of school performance and improvement efforts.
- Prepares school by school and statewide accountability information to the legislature and other entities.
- Prepares annual school by school, local education agency, and state education agency accountability reports required by the federal No Child Left Behind Act.
- Provides information regarding the performance of schools on educational indicators for improvement uses and accountability needs of the department, policy makers, and the general public.
- Provides project and program evaluation information to enable planners and managers of staff and line offices of the department to provide the most effective and efficient learning opportunities and experiences for public school students.

- Provides evaluation assistance for decision making and accountability needs of staff and line offices of the public school system by providing consultative services on evaluation of projects and programs.
- Performs other related activities, as assigned by the office director and superintendent.

Student Assessment Section

- Administers the public school system's statewide formative and summative student assessment program, which included a variety of norm and criterion-referenced tests using both traditional and performance-based measures.
- Administers the School Assessment Liaison program, which provides classroom level assessment techniques and tools to help schools and their staff measure student attainment of the content standards.
- Administers the department's participation in and compliance with the National Assessment of Educational Progress (NAEP).
- Identifies assessment instruments and practices that are used to measure system, school, and individual student attainment of the Board of Education's content and performance standards.
- Identifies assessment instruments and practices that are used to measure system, school, and individual student attainment of the statutory requirements of the federal No Child Left Behind Act.
- Provides student assessment data used in monitoring school quality and student achievement for the statewide assessment and accountability system.
- Provides assessment data for measuring compliance with the Board of Education's policies and regulations and the federal No Child Left Behind Act.
- Analyzes test results and prepares reports on the current status of, and longitudinal trends in, student performance.
- Serves as a clearinghouse of information on student assessment techniques and tools.
- Develops or collaborates with other public agencies in the development of innovative assessment techniques for possible statewide and school adoption, and for use in the statewide assessment and accountability system.
- Serves as liaison to community groups, federal offices, and state agencies and commissions involved with the development and dissemination of tests and information about tests.
- Performs other related activities, as assigned by the office director and superintendent.

3. CIVIL RIGHTS COMPLIANCE OFFICE

The Civil Rights Compliance Office supports the executive function of the Superintendent of Education by promoting equal opportunity in educational

programs and activities, equal employment opportunity, and equal access to Department of Education programs, services, and activities in compliance with various federal and state civil rights laws.

- Coordinates and promotes the public school system's equal employment opportunity program as it relates to non-discrimination on the basis of race, color, sex, religion, national origin, ancestry, age, physical or mental disability, sexual orientation, marital status, arrest and court record, income assignment for child support, National Guard absence, uniformed services, breastfeeding, and citizenship status.
- Coordinates and promotes the public school system's equal education program as it relates to non-discrimination on the protected basis, including but not limited to race, color, national origin, sex, religion, or disability.
- Coordinates and promotes the public school system's equal access program as it relates to non-discrimination on the basis of disability.
 - Publishes equal opportunity notices and information materials for dissemination to the public, students, parents/legal guardians, and/or employees.
 - Provides training to school personnel, students, parents and other groups on civil rights compliance matters.
 - Develops equal employment and equal educational opportunity policies for adoption by the Superintendent of Education and the Board of Education.
 - Responds to inquiries concerning the civil rights of students, employees, and the public; provides advice and assistance to school officials and program managers regarding compliance with federal and state civil rights statutes and regulations.
 - Coordinates the department's response to compliance reviews and complaint investigations conducted by federal and state civil rights enforcement agencies such as the U.S. Equal Employment Opportunity Commission, U.S. Department of Education's Office for Civil Rights, U.S. Department of Justice, and the Hawaii Civil Rights Commission.
 - Conducts investigations of alleged civil rights violations in the public school system and/or supplements investigations conducted by school officials and program managers.

4. COMMUNICATIONS AND COMMUNITY AFFAIRS OFFICE

The Communications and Community Affairs Office supports the executive function of the Superintendent of Education by developing the internal and external communication programs of the public school system, developing education partnership programs with the various sectors of society (e.g., parent, community, business, military, government, etc.) and resolving public conflicts concerning the programs and activities of the public school system.

- Provides communications services to the Superintendent of Education and all other offices and schools of the public school system, as needed.
 - Advises the superintendent and other personnel on public affairs

- implications of proposed actions or decisions.
- Attends Board of Education and superintendent’s staff meetings and Leadership Team meetings as appropriate.
 - Drafts letters, memos, public statements and speeches upon request of the superintendent.
 - Advises and assists other state and district offices and schools in publicizing their activities.
 - Prepares departmental news for all personnel, as appropriate.
 - Publishes the *InfoExchange* newsletter in conjunction with regular Board of Education meetings to report DOE matters to the BOE and BOE/DOE matters to the schools and public.
 - Reviews and recommends for printing all official publications of the department.
 - Develops among all personnel an awareness of the need for good public relations and assists key personnel in developing communications skills through membership in professional organizations, provision of materials and training sessions, as needed.
 - Monitors and evaluates communications needs and the department’s efforts to meet those needs.
- Plans and coordinates activities for communicating with the general public.
 - Responds to news media, group and public requests for information, including Chapter 92F, Uniform Information Practices Act, H.R.S., and responds to_or refers inquiries to appropriate sources,
 - Issues news releases on major state-level actions, and departmental plans, programs, and activities deemed of interest and importance to the general public.
 - Schedules and handles arrangements for news conferences.
 - Generates and suggests story ideas for the media.
 - Prepares informational pamphlets and other materials to serve public information needs.
 - Promotes and maintains good relationships between the department and special public and individuals through a variety of appropriate means, such as membership on boards and committees.
 - Provides coordination of information to the superintendent, media, schools, and general public as needed on matters relating to school closures, bomb threats, and other health, public safety, and civil defense emergencies affecting the public schools.
 - Coordinates promotion of partners-in-education programs with various sectors of the community: business, trusts and foundations, and other government agencies.

- Supports the establishment of locally based community bodies with extensive family participation to advise the department on the delivery of Special Education and related services.

5. INTERNAL AUDIT OFFICE

The Internal Audit Office provides independent, objective assurance and consulting services to add value and improve the DOE's operations and internal control structures. Internal Audit assists the DOE to accomplish its objectives by bringing a systematic, disciplined approach to evaluate and contribute to the effectiveness of risk management, control, and governance processes.

The Internal Audit Office's primary responsibilities include reviewing the effectiveness of the internal control structure, identifying opportunities for process and control improvements that would mitigate risk exposures, monitoring compliance with laws, regulations, policies and procedures, and sharing best practices throughout the DOE. In carrying out these primary responsibilities, the Internal Audit Office will, among others:

- Annually develop and execute a flexible audit plan using an appropriate risk-based methodology, for the evaluation of critical financial, operational and compliance processes that provide oversight and controls to the DOE.
- Review and monitor that corrective action plans, recommendations for improvement, and correction of reported deficiencies resulting from internal, external, or legislative audits, have been effectively implemented and addressed.
- Coordinate audit activities with the State Department of Accounting and General Services (DAGS) Audit Division, the Office of the Legislative Auditors, and external auditors to ensure proper coverage and minimize duplication of efforts.
- Examine the effectiveness of all levels of management in their stewardship of DOE assets and resources.
- Conduct investigations of allegations concerning DOE fund or asset misappropriations.
- Promote understanding and appreciation of internal controls and their application to the DOE's operations through written and oral, formal and informal, communications with management and the Audit Committee, where applicable.

The Internal Audit Office is independent of all other departments within the DOE, and is free from undue influence in selecting and determining the scope of activities, performing examinations, and communicating the results. The Internal Audit Director reports directly to the Superintendent of Education and the Audit Committee of the Board of Education.

6. DATA GOVERNANCE OFFICE

Provides support to the Department of Education as it relates to the development, implementation, facilitation, and efficient administration of grants, research, K12 Longitudinal Data System (LDS) and data use.

Research and Data Use: Manages and administers the Family Educational Rights and Privacy Acts (FERPA), research applications, and retention and records program.

This section administers the department's record management program.

- Reviews applications or proposals to conduct surveys or research projects in the schools and formulates a recommended action and correspondence for the superintendent's signature.
- Plans, coordinates, and develops procedures and guidelines for access to personally identifiable records within the department.
- Serves as the department's liaison with the Office of Information Practices.
- Plans and coordinates the archiving of student records, including providing consultative services to school staff on preparing the records for archiving.
- In consultation with the DAGS records management program staff, develops and maintains the retention schedule for department unique records.
- Manages and administers the administrative rule regarding the educational rights and privacy of students and parents.

Grants Management: Provides technical assistance to the DOE schools/offices with regard to successfully applying for and achieving external and internal grants.

This section administers the department's grants management program.

- Develops and implements funding and resource acquisition strategies to achieve the department's mission.
- Provides technical assistance to users of the grants management system.

7. OFFICE OF STRATEGIC REFORM

The Office of Strategic Reform (OSR) serves as a catalyst for a performance-based culture and aligned organization, and is directed by the Assistant Superintendent for Strategic Reform. The Assistant Superintendent will report directly to the Superintendent and be responsible for project management oversight of strategic initiatives. Under the guidance of the Assistant Superintendent, the Portfolio Managers would focus on critical implementation deliverables within the four main pillars of the HIDOE Reform Action Plan, to include support for:

- Building HIDOE capacity to ensure effective implementation of Race to the Top and Strategic Plan reforms (Assurance A);
- Implementation of the college- and career-ready diploma and achievement of HIDOE STEM goals (Assurance B and STEM);
- Effective use of data to improve instruction and inform research efforts (Assurance C);
- Teacher and leader effectiveness (Assurance D); and
- Zones of School Innovation (Assurance E);

The Office of Strategic Reform will function for seven years, the duration of HIDOE's 2011-18 Strategic Plan. A key function of OSR is to facilitate the transformation of HIDOE to a performance- and outcomes-focused organizational culture. Initially funded by Race to the Top resources, OSR's primary funding would be taken over by the reorganized HIDOE in 2015, and the functions would shift exclusively to monitoring performance and sustaining reforms statewide.

DEPARTMENT OF EDUCATION
OFFICE OF THE DEPUTY SUPERINTENDENT
FUNCTIONAL STATEMENT

DEPUTY SUPERINTENDENT OF EDUCATION

The deputy superintendent assists the Superintendent of Education in executing duties and responsibilities of the office, and is delegated authority to act for the Superintendent of Education. The deputy superintendent is responsible for leading, directing and supervising the academic/education programs of the Department of Education. This position oversees the department's 15 Complex Areas, Military Liaison Program, Special Projects and the Office of Curriculum, Instruction and Student Services.

1. COMPLEX AREA SUPERINTENDENTS

Public schools are assigned, for administrative purposes, to complex areas of one or more school complexes, each consisting of a high school and its feeder middle and elementary schools. There are fifteen (15) complex areas in the statewide public school system. Each complex area is supervised by a complex area superintendent who reports directly to the Deputy Superintendent. The complex area superintendent assists individual schools and school complexes in meeting the Hawaii Content and Performance Standards, Hawaii Goals for Education, and the education renewal initiatives of the state and federal government. Complex area superintendents exercise supervision over school renewal specialists and other educational support personnel and monitor the provision of centralized fiscal, personnel, and facilities support by other DOE state offices to facilitate school renewal efforts.

Complex Area Superintendent

- Supervises schools in a complex area and provides area-wide program coordination and support of special education, special services, and federal-funded programs.
- Provides area-wide program coordination and support of special education, special services, school-based mental health and federal-funded programs.
- School-Based Support Services: Occupational and Physical Therapy Program
 - Administers the Occupational and Physical Therapy Program (OT/PT)
 - Coordinates with the schools to identify health problems and occupational and/or physical therapy needs as related to the students' educational programs in the district.
 - Assures appropriate resources to the schools to provide occupational and/or physical therapy services to support the educational program of identified students.
 - Consults with school personnel, families and others to assure that there is integration of educationally related OT/PT strategies into the school curriculum and home.

- Collects appropriate data to assure compliance of timelines and that eligible students are receiving the necessary occupational and/or physical therapy services.
- Collaborates and coordinates with the state office to assure that there is conformance with program standards and established procedural guidelines.
- Coordinates with the state office for orientation of new occupational and/or physical therapists.
- Coordinates with the schools to assure appropriate office space for the therapy staff within the district.
- Reviews each school's strategic and academic/financial plans for, and progress towards, attaining effective school status.
- Provides consultation and professional assistance to schools and complexes to ensure sound planning, effective implementation, and efficient use of available school resources for curriculum, instruction, and student services reform aspects of school renewal.
- Facilitates, monitors, and assesses the effectiveness and responsiveness of fiscal, facilities, personnel, information and telecommunications, and other administrative support services that are centrally administered by DOE state offices and other state agencies; maintains liaison between schools and the central services agencies to assure that services meet current operational and projected school renewal requirements.
- Coordinates schools' requests for assignment of school renewal specialists from Office of Curriculum, Instruction and Student Support or from other complex areas or complexes to assist a particular school or complex in its restructuring efforts; exercises field supervision over school renewal specialists who are assigned to assist the schools and complexes.
- Promotes collaboration among schools in each complex to articulate their educational programs and student performance expectations, coordinate school renewal and improvement efforts, and share resources.
- Coordinates sharing of resources among complexes in the area, and cooperative support arrangements between complex areas.
- Develops and maintains collaborative partnerships with the University of Hawaii and other institutions of higher learning to support school renewal efforts of the complex area schools.
- Maintains liaison with government, community, and business organizations and officials on matters of mutual interest involving the complex area's schools.
- Conducts meetings and hearings to ensure administrative due process for students and employees of the complex area in accordance with law and department rules and regulations.

Schools

Public schools assigned to the complex areas include elementary, intermediate and middle schools, high schools, special schools for qualified students with

disabilities, and institutionalized juvenile delinquents, offering instruction in grades K-12; and community schools for adults.

Complex Learning Support Centers

Complex learning support centers facilitate sharing of curriculum and instructional resources among schools of a school complex, which consists of a high school and its feeder elementary and intermediate or middle schools. The complex learning support centers provide technical support to schools in the complex. In addition, there is much collaboration between and among support centers.

2. MILITARY LIAISON

Develops, implements strategy to facilitate interaction between the DOE and the military community involving the Joint Venture Education Forum and other identified community groups.

3. OFFICE OF CURRICULUM, INSTRUCTION AND STUDENT SUPPORT

Office of Curriculum, Instruction and Student Support (OCISS)

This office is a flexible organization which supports system-wide accountability, systems requirements, standards-based curriculum, instruction, and student support. This includes primary responsibility for coordination and implementation of the Department's initiatives to meet the requirements for state and federal mandates. The office is under the direction of the Assistant Superintendent; the responsibilities of the office are performed by the Student Support Branch and Curriculum and Instruction Branch.

Student Support Branch

This branch provides leadership, support, and research in establishing an array of services including extended learning opportunities, monitoring appropriate state and federal mandates, and professional development for student support.

Extended Learning Opportunities and Student Support

The section provides support for the development and implementation of expanded learning opportunities that include the use of instructional technologies, multimedia resources and non-traditional environments and/or school day.

- Provides statewide leadership in extended learning programs, educational resources, multimedia programs and materials, and consultative services that model the use of 21st century skills and new technologies for students, educators, and administrators.
- Prepares students and educators for the 21st century workforce through technology rich, standards-based credit courses for students and best practices, online professional development and resources for educators through programs such as Hawaii Virtual Learning Network and distance learning.
- Develops, maintains, and provides online, distance learning, and video conferencing programs and systems.
- Provides support and technical services to Community Schools for Adults in programs such as Adult Basic Education, Adult

General Education, English as a Second Language, English Literacy/Civics, Workplace Literacy, Family Literacy and cultural, recreational and social enhancements, and monitors programs for compliance with state and federal requirements.

- Provides support and technical services for student leadership development, enrichment, and acceleration.

Comprehensive Student Support Services

This section provides a focused and responsive system of supports to strengthen the social, emotional and physical well-being of all students and their families and communities to impact student achievement.

- Provides leadership and support to schools in implementing a Comprehensive Student Support System (CSSS).
- Works with complexes and schools to ensure that supports are available to reduce barriers to learning and facilitate educational achievement.
- Focuses on preventive and developmentally appropriate supports and services for all students; provides for intervention and tertiary services to address to students in need.
- Provides program direction and guidance for parent and family support services, early childhood intervention services, secondary school intervention services, psycho-social-emotional services, positive behavior support services, and student health services.

(NCLB) – School Improvement Programs

This section provides coordination and technical oversight on the State Framework for School Improvement and Title I grant administration to schools, complex areas, and state offices of the Department.

- Administers, on a statewide basis, No Child Left Behind federal mandates, and other federal grant programs.
- Provides technical assistance to Title I schools through the school improvement process to ensure that all children meet challenging state academic standards.
- Coordinates and develops support services to supplement the Framework for School Improvement.
- Partners with Charter School Administrative Office to provide oversight, technical assistance, and monitoring of Title I charter schools.
- Provides oversight over all Title I programs assigned to the (NCLB) School Improvement Programs Section, including the Private School Title I Program.

Athletics

This section provides statewide leadership for and the coordination of the interscholastic athletics program by serving as consultant and liaison to the public school district athletics specialists and main point-of-contact between OCISS and the complex areas.

- Provides statewide leadership for the interscholastic athletics program by serving as consultant and liaison to the public school district athletics specialists and main point-of-contact between OCISS and the districts.
- Provides guidance and consultation in completing systems tasks relating to athletic programs.
- Plans, develops, and implements staff development activities for school personnel involved with athletics to ensure quality and effective program implementation and operation.

Curriculum and Instruction Branch

This branch supports schools and complex areas through the research and development of standards-based education for all students. The branch develops guidelines and procedures, and provides technical assistance and support for implementation. The branch monitors organizational effectiveness in meeting state and federal mandates for student achievement and school improvement.

School Literacy Improvement and Innovation

This section provides leadership and research through the development of standards-based curriculum, assessment and instructional tools/resources that support literacy and innovations in content areas.

- Assesses, analyzes, evaluates, and addresses the needs of students, complex areas, complexes, and schools in relation to the effective implementation of the Hawaii Content and Performance Standards.
- Researches and develops tools to support instructional programs to meet the needs of students and teachers in the various curricular areas.
- Develops curricular guidelines and standards for application throughout the school system.
- Develops curriculum frameworks and other resource materials to guide and stimulate curriculum development and standards implementation in the schools.
- Provides professional development opportunities to complex areas and complexes in planning, developing, delivering, and assessing standards-based education.

Special Education

This section ensures that all children/youth with disabilities have available a free appropriate public education. The Section ensures

that the rights of children/youth with disabilities and their parents are protected, and monitors, enforces and reports on the implementation of federal and state special education requirements.

- Develops procedures, standards and policies, and rules for the education of individuals with disabilities, ages 3 to 20, for application throughout the school system.
- Provides technical assistance and training to complex areas, districts, schools, other cooperating agencies, and parents to address the Individuals with Disabilities Education Act (IDEA), and the corresponding administrative rule.
- Monitors the activities of schools and complex areas to ensure conformance to program standards, established instructional policies, and legal and administrative directives.
- Provides leadership, technical support and training to complex areas, schools, and parents in organizing the instructional and student support components to maximize the use of available resources.

School Improvement and Redesign

This section provides support through the research and dissemination of innovative products/best practices and dynamic technical assistance to continuously improve school quality and performance.

- Provides leadership, professional development, and technical assistance to schools and complex areas in planning and implementing School Community Councils (SCC), shared decision-making, and school improvement focused on increasing student achievement.
- Coordinates the review and approval process of all SCC waivers and exception requests to BOE policy and collective bargaining agreements.
- Provides leadership, support, and technical assistance to schools in planning, implementing, and monitoring secondary school redesign (middle school reform and high school redesign).
- Provides leadership, coordination, and oversight of the school accreditation process.
- Provides coordination and support in implementing and planning school improvement activities.

Hawaiian Education Programs

This section provides the resources needed to fully implement the goals and objectives of Hawaiian education to include the study of Hawaiian culture, history, and language in the public schools along with the achievement of the Hawaii Content and Performance Standards.

- Provides leadership in the development of culturally relevant educational programs which use Hawaiian culture, history, language as the foundation for the achievement of the Hawaii Content and Performance Standards.
- Assesses, analyzes, evaluates, plans and develops tools and resources to support the needs of students, complex areas, complexes, and schools in relation to the effective implementation of Hawaiian education programs such as the Hawaiian Studies Program and the Hawaiian Language Immersion Program.
- Works in partnership with Hawaiian organizations and agencies in support of the State Constitutional mandate to promote Hawaiian education within the public school system.

4. SPECIAL PROJECTS

Addresses academic/educational issues that are significant to the Department of Education and that impacts several offices. These projects include operational, technical, and project management projects that support the missions and strategic plans of the Department of Education. Special Projects also support the Department by administering on-going U.S. Department of Education funded programs. This office serves as the primary Department contact with federal program officials regarding state education agency responsibilities outlined in federally funded education programs and provides guidance and monitoring functions to Department staff implementing such programs.

5. ADMINISTRATIVE SUPPORT MANAGEMENT

Provides administrative and fiscal management support on academic/educational issues that are significant to the Department of Education.

DEPARTMENT OF EDUCATION

OFFICE OF THE “SENIOR” ASSISTANT SUPERINTENDENT FOR ADMINISTRATIVE AFFAIRS

FUNCTIONAL STATEMENT

“SENIOR” ASSISTANT SUPERINTENDENT FOR ADMINISTRATIVE AFFAIRS

The “Senior” Assistant Superintendent will supervise, direct and provide the strategic visioning leadership for the administrative offices that support the Department of Education. These offices include the Office of Fiscal Services, Office of Human Resources, Office of Information Technology Services, Office of School Facilities and Support Services, and Standard Practices.

1. OFFICE OF FISCAL SERVICES

The Office of Fiscal Services manages the Department of Education’s (DOE) accounting, budget, and procurement activities and systems to serve the needs of the schools, school complexes, complex areas, and the state central office. The office is responsible for the following:

- Developing and implementing long-term and short-term financial activities.
- Leading the department’s accounting, budgeting, and procurement operations.
- Providing timely, accurate, and user-friendly information and reports in each of the respective areas, i.e., clear guidelines/procedures for completion of documents, and that the guidelines/procedures are aligned with the department’s goals and objectives.

ACCOUNTING SERVICES BRANCH

The Accounting Services Branch provides accounting, payroll, vendor payment, fixed assets, inventory, and fiscal operations school-, complex area-, and state-level support in the public school system; and coordinates copy machine services in the DOE offices located in the Queen Liliu’okalani Building.

Accounting Section

The Accounting Section administers and accounts for all funds, expenditures and financial commitments incurred by the department through a centralized accounting system in conformance with the state comptroller’s rules and regulations. The section assists schools and offices in developing and implementing corrective actions in response to audit compliance issues. The section develops training modules and assures that all appropriate personnel are trained in accounting, cash management, payroll, vendor payments, fixed assets, and inventory transactions. The section also serves as the department’s liaison to the State’s Risk Management Program.

Reporting, Analysis, and Account Reconciliation Functions

- Provides regular monthly, quarterly, and annual financial reports and detailed transaction reports of the department’s financial operations, specialized reports to the courts, legislature, federal government, and other reports as required.
- Provides financial support for the transfer of funds between No Child

Left Behind grants.

- Prepares monthly BOE financial and ad hoc reports.
- Prepares annual financial reports for grants received from federal, state agencies, and other non-profit organizations.
 - Prepares the National Public Education Financial Survey to the National Center of Education Statistics (NCES) cross-walking department expenditures to conform to the Common Core of Data which is used to determine state funding allocations for Title I, ESEA Programs (Migrant, Handicapped, Neglected and Delinquent Children), Impact Aid, Indian Education, and Individuals with Disability Act (IDEA) grants.
 - Prepares the Annual Survey of Local Government Finance report that is aggregated by the U.S. Census Bureau to compare revenue and expenditure resources by local education agencies.
 - Prepares the quarterly and annual Principal's Financial Report from each school to report the quarterly activity to the state comptroller for the non-appropriated local school funds.
 - Prepares the department's indirect cost rate proposal to the federal government to negotiate a rate agreement for use on the department's federal grants to reimburse the state for central services costs.
- Provides technical and consultative assistance to state, complex area, and school level personnel relative to accounting procedures, regulations, and the financial management of their accounts.
- Prepares the trial balance, income statement, statement of cash flows, and all audit schedules, including leases and liability accruals, for the department as requested by the external auditors for the department's annual financial and single audit.
- Provides technical support to external auditors for the department's annual financial and single audit.
- Updates the department's Uniform Accounting Codes, which is published in the Financial Management System (FMS) User Policy and Process Flow Guide, Chapter 2, Accounting Codes.
- Updates and maintains the FMS accounting code tables and develops and maintains interface programs to perform accounting functions effectively and efficiently.
- Develops and establishes accounting processes for new FMS requirements.
- Processes form FMS-AC4, Request for Change of Accounting Codes &/or Amounts, from all schools and offices requesting corrections for revenues or expenditures in their bond, general, federal, special, and trust fund accounts.
- Reviews and makes corrections to Department of Accounting and General Services (DAGS) semi-monthly payroll cost interface received from DAGS into the department's FMS.
- Maintains and updates the TSEAS Prog IDs for processing and accounting for TSEAS cost.
- Maintains and revises FMS "job coding" system, FMS mid-year and year-end close processes, inception-to-date and transactions year financial reports, and provides continuous coding for new appropriations and projects and FMS enhancements in order to accommodate R&M/CIP responsibilities transferred from DAGS.

Public Charter School Program Functions

The Public Charter School Program assures delivery of State Education Agency/Local Education Agency (SEA/LEA) services required by federal and local legislation and for which the department is responsible.

- Responds to queries related to charter schools in relation to department responsibilities.
- Optimizes the intent of state legislation related to public charter schools by providing oversight of the MOA process and purchase of services by charter schools.
- Facilitates the delivery of services “purchased” by charter schools.
- Prepares invoices and collect payment related to purchase of services.
- Responds to queries related to Budget System and FMS use.
- Serves as the department’s liaison to the Charter School Administrative Office (CSAO) and Charter School Review Panel.

Cash Management Functions

- Accounts for all cash receipts from schools and offices.
- Maintains multiple central collections accounts for all receipts from schools and offices and to download bank deposit information from the commercial bank to school accounts to support general school, school lunch, student transportation, and after-school lunch collections.
- Prepares treasury deposit receipts (TDR) to summarize transactions from schools by funds, source codes, and object codes to the state treasury.
- Reconciles monthly the multiple central collection account balances to the bank statement.
- Monitors federal grant cash requirements daily and draws-down cash semi-monthly and, as needed, for all federal grants received by the department through the GAPS, Smart Link, and ASAP payment systems.
- Provides financial data to Budget and Finance (B&F) to monitor selected federal accounts to meet the federal Department of Treasury Cash Management Improvement System (CMIA) monitoring requirements.

Loss and Casualty Claims Management Functions

- Serves as the department’s liaison to the State’s Risk Management Program.
- Identifies and evaluates the department’s exposure to property and liability loss to minimize the total insurance, property, and casualty losses costs.
- Develops, implements, and monitors effective loss control programs.
- Develops, formulates, and implements insurance, property, and casualty losses management policies and procedures; coordinates and evaluates programs with the State’s Risk Management Office.
- Coordinates insurance activities and management of loss documentation through assisting the schools and offices with processes and appropriate forms for seeking reimbursement for losses through the State’s Risk

Management Program.

- Provides training on insurance processes, forms, and yearly requirements.

Fixed Assets Functions

- Manages repair & maintenance and construction-in-progress (R&M/CIP) financial responsibilities received from DAGS for general, special, and bond funds. These responsibilities include providing monthly/annual financial reports; posting appropriations, allotments, and cash; special fund assessments; and providing on-going technical assistance.
- Reconciles the department's operating and R&M/CIP fund accounts to the DAGS accounts.
- Administers, controls, coordinates, monitors, and maintains a comprehensive computerized inventory management, accounting, and reporting system for the department in compliance with state, federal, contract and donated requirements relative to the department's acquisition, transfer, disposal, and claim for lost/stolen properties.
- Prepares the fixed asset roll forward schedules for the department as requested by the external auditors for the department's annual financial and single audit.

Operations Section

- Supervises the auditing of all payments for employees.
- Provides training and assistance to the department in all activities of the payroll and vendor payment functions.
- Serves as the liaison with other state agencies in payroll and vendor payment matters.
- Administers and coordinates the Purchasing Card (P-card) program for the department.

Services and Procedures Unit

- Directs, coordinates, supervises, and participates in the analysis, design, development, acceptance, implementation, evaluation, improvement, maintenance, and control of the state and the DOE computerized central accounting systems or parts thereof.
- Provides staff services to develop, recommend, and implement procedures which relate to the Operations Section.
- Conducts special studies and research, ranging from technical accounting matters to day-to-day operational concerns.
- Evaluates, monitors, and updates criteria for the reporting of mileage and other payments made to employees and independent contractors in order to comply with federal and state tax reporting requirements.

Payroll Unit

- Pays all DOE employees (certificated, classified, hourly) twice a month in conjunction with collective bargaining contract provisions.
- Posts and maintains records of individual earnings for each DOE employee.

- Processes and performs final pre-audit of all payroll input for central preparation of DOE payrolls under EDP procedures to assure all employees are properly compensated. Checks payments authorization, legality, and propriety. Effects deductions for garnishments, assignments, tax liens, and court orders. Controls mandatory withholdings, deductions, and assignments. Prepares and processes priority payroll payments.
- Maintains leave earnings of the DOE employees. Audits and processes all leave requests to ensure hourly/daily charges applied correctly to leave balances in conjunction with bargaining unit contract provisions. Pre-audits hourly/daily earnings reported to date on "Applications for transfer of vacation and sick leave credits or payments in lieu of vacation." Calculates hourly/daily earnings to dollars and effectuates salary change schedule to make payment.
- Processes and audits workers' compensation payments and wage separation reports for unemployment insurance purposes.
- Verifies employment and wages for financial institutions, Hawaii Housing, and the Department of Human Services.
- Manages and maintains a centralized billing, collection, and accounting program for overpayment collection.
- Writes, updates, and maintains the DOE Payroll handbook. Provides guidance, assistance, and training to the schools and offices of all aspects of payroll.
- Pre-audits and processes salary assignment and savings bond forms.

Vendor Payment Unit

- Pays all DOE vendor obligations within 30 days of receipt of goods/services.
- Locates and verifies errors, analyzes cause, and adjusts/corrects system.
- Performs final pre- and post-audit for legality and propriety of claim vouchers, covering payment for all DOE obligations; examines invoices, approval to pay, contracts, and other authorizing documents to confirm validity and accuracy of claims; maintains auxiliary records of travel and other claims.
- Controls the activities relating to the issuance of the DOE Vendor Payment checks, maintains records and authorizations relating to disbursement of checks, and maintains cash records and authorizations relating to disbursement of checks, and maintains cash records of all bank deposits and withdrawals.
- Reports expenditures to the statewide Financial Accounting and Management Information System (FAMIS) and reimbursement from DAGS.
- Develops, implements, and updates travel policy guidelines for the department; tracks and updates out-of-state travel database for future references and inquiry.

BUDGET BRANCH

The Budget Branch assists the chief financial officer (CFO) in the preparation and execution of the public school system's operating budget.

Budget Preparation Section

The Budget Preparation Section administers the preparation and development of the department's biennial and supplemental operating budgets. The section is responsible for the following:

- Prepares the biennial and supplemental operating budgets for the public school system, except for public charter schools.
- Prepares current services budget, projecting salary requirements and reconciling the level of funding to appropriations and ceilings.
- Develops and disseminates budget instructions, standards, and tables to schools, offices, and attached agencies, such as the Hawaii Teacher Standards Board (HTSB).
- Assists schools and offices with the preparation of budget requests, including implementation of a modified version of zero based budgeting.
- Reviews budget requests for accuracy, adequate justification, and adherence to standards.
- Coordinates the development of budget priorities and budget standards in all resource categories.
 - Recommends appropriate alternatives to meet the department's budget requirements.
 - Performs review and analysis of budget requests from schools, offices, and other agencies to address critical needs and priorities.
- Coordinates the department's development of the variance report for the multiyear program and financial plan component of the Planning-Programming-Budgeting System by providing instructions, schedules, and technical assistance to program managers.
- Coordinates with the Office of Human Resources (OHR) and program managers to monitor manpower requests to assure positions established for DOE schools and offices are within the budget.
- Provides technical assistance in budget preparation and presentation to the Board of Education (BOE), governor, Department of Budget and Finance (B&F), the legislature, state offices, complex area offices, and schools.
- Provides training and consultative services staff to develop, maintain, update, and enhance the budget preparation system to support budget functions.
- Prepares publications and communications for budget preparation.

Budget Execution Section

The Budget Execution Section administers the implementation of the department's operating budget, monitoring adherence to policies and procedures, and making adjustments to meet anticipated needs or restrictions. The section is responsible for the following:

- Allocates funds and positions to state and complex area offices and schools.

- Analyzes the appropriations act and legislative worksheets to obtain details of approved budgets and legislative intent.
- Reviews and interprets policies and procedures issued by B&F, and implements allotment changes made by the Director of Finance.
- Analyzes staff recommendations for allocation formulas and other criteria for allocating funds and positions to schools and complex area offices.
- Prepares and disseminates initial allocations to state and complex area offices, and schools.
- Adjusts allocations throughout the year to reflect buy/sell of positions, transfer of funds between programs, and other authorized flexibility measures.
- Reconciles appropriations, allocations, and allotments throughout the year.
- Completes year-end close and carryover process.
- Develops and disseminates expenditure plan instructions.
 - Prepares allotment requests (A-19).
 - Provides follow-up and liaison work with B&F and the Department of Accounting and General Services (DAGS).
 - Reconciles allotments with expenditure plans, the DOE's Financial Management System (FMS) and DAGS' balances for each appropriation and fund.
- Monitors and manages the department's budget.
 - Analyzes, solicits input, and implements reductions to appropriations and allocations by EDNs and programs.
 - Monitors and manages salary and other payroll accounts.
 - Implements flexibility provisions of lump sum budgeting (buy/sell of positions, transfer of funds, and carryover).
 - Reviews programs for budget strategies and more efficient use of operating funds.
 - Analyzes the department's financial plan and makes adjustments necessary to meet unanticipated needs or restrictions.
- Coordinates budget execution matters with external agencies, policy makers, and decision makers (B&F, legislature, auditors, BOE, superintendent, complex area and school personnel).
 - Researches and prepares reports and testimonies in response to inquiries.
 - Recommends appropriate strategies to execute the budgetary requirements.
- Coordinates system support with the Information System Services Branch.
 - Maintains tables related to the computerized budget system.
 - Prepares data files and reports required to review and analyze the budget.
 - Coordinates and monitors data transfers to data base files, i.e., Data Warehouse.
 - Provides budget execution requirements when evaluating various information systems.

- Other responsibilities.
 - Manages the Impact Aid Program, P.L. 103-382.
 - Assists in planning and development of operating biennial budgets, supplemental budgets, and other budget functions.
 - Coordinates with other state offices to facilitate budgetary and fiscal procedures within the department.
 - Prepares publications and other communications for budget execution.
 - Provides budget execution training and consultative services to schools through budget hotlines and presentations for school administrators, clerical personnel, and other program managers.
 - Coordinates, assists, prepares, and implements the Weighted Student Formula (WSF) Project Financial Plan.
 - Provides data elements/queries, analyses, and recommendations to the Committee on Weights (COW).
 - Assists schools with the coordination and implementation of the financial portion of the Academic/Financial Plan for schools, and the Indexed Complex Area Allocation for complex areas.

PROCUREMENT AND CONTRACTS BRANCH

The Procurement and Contracts Branch services all schools and offices by (1) performing periodic reviews of procurement practices; (2) providing assistance, advice, guidance, and training in matters relating to procurement and contracting; (3) developing and revising procurement and contracting policies and procedures; (4) preparing and formalizing bid specifications, solicitations, and contract documentation for specific goods, services, and construction as requested by schools/offices and/or for select commonly-used departmental commodities or services; and (5) issuing formal solicitations and awards in compliance with applicable laws and regulations.

Procurement and Contracts Section

The Procurement and Contracts Section's responsibilities include:

- Maintains thorough knowledge of current laws, rules, policies, regulations and procedures governing the department's centralized procurement and contracting activities; studies laws, rules, regulations, and policies as they affect procurement and contracting procedures.
- Develops bidding procedures and contract methods for routine to the most complex, specialized and technical projects; studies the impact of the program on outside activities or the effect of changes of outside activities on the program (e.g., changes in commodity prices, business practices, shipping strikes, etc.).
- Prepares specifications, terms and conditions to meet the minimum requirements of the user while assuring maximum competition based on the purchaser's needs; determines whether bids meet specifications and legal requirements; and develops specifications for the establishment of new price lists.
- Prepares procurement notices; tabulates and summarizes bid results, analyzes and evaluates offers to determine the most advantageous offer, recommends awards, and issues award upon purchaser's approval.
- Prepares resultant contracts in accordance with state and federal laws, rules and regulations and with program objectives and requirements;

prepares any price list addenda or renewals; prepares contract modifications and/or terminations according to applicable laws, rules and policies.

- Reviews for sufficiency the justification and statutory compliance for sole source, emergency, exempt or restrictive purchases and recommends such action when appropriate.
- Assists in the identification of problems or concerns with the terms and conditions of the contract; recommends additional terms and conditions after careful consideration of the issues in consultation with the Purchaser; gathers information for/from vendors and provides clarification to questions/concerns regarding the execution of the contract; reviews certificates of compliance.
- Reviews contracts for compliance with applicable policies, rules, regulations and laws and provides technical assistance to program staff in the development, management, and execution of contracts.
- Problem-solves a wide range of complaints which could not be resolved at lower levels regarding procedures, policies, product quality, contract performance, late payments, unfair or biased actions.

Procurement Assistance, Compliance, and Training (PACT) Section

The Procurement Assistance, Compliance, and Training (PACT) Section is responsible for the following:

- Serves as technical resource to the Chief Procurement Officer, administrators, and bidders to ensure compliance with the Procurement Code, applicable state and federal administrative rules and regulations applicable to purchasing mandates and guidelines, other policies or procedures governing state agencies and organizations, and departmental policies or procedures.
- Conducts periodic reviews of departmental procurement practices, including recommending appropriate revisions to procurement policies and procedures.
- Assists in conducting fact-finding investigations and making recommendations in the event vendors fail to perform according to the contract term and conditions; and investigates inquiries, complaints or controversies from department purchasers and/or vendors or contractors; reports findings of facts and may recommend appropriate or corrective action or refer the case to the Department of the Attorney General, as appropriate.
- Conducts periodic audits of school and offices in all areas of procurement and contracting to evaluate compliance with the Procurement Code and departmental policies and procedures, including the preparation of reports and briefing of senior management officials on the findings and recommendations to correct procurement and contracting deficiencies or refer the case to the Department of the Attorney General, as appropriate.
- Assists schools and offices in developing and implementing corrective actions in response to audit compliance issues.

OFFICE OF HAWAII CHILD NUTRITION PROGRAMS BRANCH

- Develops and administers the USDA Food Nutrition Programs which receive funds and commodities from the USDA grants for the State of Hawaii.

- Serves as the State Agency (SA) and primary contact with the USDA for all issues concerning the administration and operation of all Food Nutrition Programs in Hawaii.
- Administers and oversees the following USDA Food Nutrition Programs:
 - National School Lunch Program
 - School Breakfast Program
 - Child and Adult Care Food Program
 - Commodity Distribution Program
 - Summer Food Service Program
 - Special Milk Program
- Provides program marketing and advocacy initiatives, technical assistance, and oversight for all USDA Food Nutrition Programs.
- Prepares budgets, expenditure plans, and financial reports and projections for the SA.
- Reviews SA federal grant reports and monitors for compliance with federal program requirements.
- Provides technical assistance in developing and administering fiscal policies and procedures.
- Orders, allocates, and distributes commodities.
- Coordinates with the USDA to provide food for disaster relief for the State of Hawaii.

HEALTH CARE CONTRACTS AND REIMBURSEMENT SECTION

- Administers the Medicaid Reimbursement Program.
- Develops, implements, and evaluates reimbursement regulations, methodologies, and rates for health care services, supplies, and equipment.
- Develops, procures, monitors, and reviews contracts with individual health care providers, institutions, and fiscal agents.
- Manages and coordinates the use of the Medicaid information system.
- Manages and monitors the Third Party Liability recovery program and other claims.

2. OFFICE OF HUMAN RESOURCES

The Office of Human Resources (OHR) administers a comprehensive personnel program for certificated, classified, and casual employees of the public school system within the framework of established laws, policies, and accepted principles of personnel management. OHR develops and administers administrative rules and regulations; publishes operational guidelines; and provides centralized employment and personnel administration services to schools, district and state administrative offices to ensure that the support is being provided efficiently and effectively. OHR collaborates with the state and district administrative to provide comprehensive services. OHR provides staff to state and district administrative offices in personnel areas which include but are not limited to recruitment, labor relations and contract administration, employee

relations and services, and criminal history records checks. The scope of the comprehensive personnel program includes the following services:

- Recruitment, selection, and employment processing
- Reclassification
- Certification of educational officers
- Leave administration
- Personnel resource accounting and position allocation
- School administrator training
- Employee awards and recognition
- Criminal history record checks
- Temporary Disability Insurance Program administration
- Collective bargaining and negotiations
- Labor Relations and contract administration
- Health benefits, tax shelter annuity 403(b), Premium Conversion Plan, Deferred Compensation Program, PTS Program, Flex Spending, service awards, retirement awards and certain other awards.
- Classification and compensation systems
- Fair labor practices and equal employment opportunity
- Employee development and training
- Performance Management systems
- Workers' Compensation Program administration
- Employee safety and security administration

Under the direction of the assistant superintendent and the directors of OHR, these services are provided directly, or coordinated throughout the public school system, by the following groups: Recruitment Section; Classification and Compensation Section; Records and Transactions Section; Certificated Personnel Regional Officers; Labor Relations Section; Negotiations Section; Workers Compensation, Health Benefits, and Awards Section; Performance Management Section; Human Resources Units; Training and Certification Section; Induction, Monitoring and Professional Development Section; Management Support Services Section; Professional Development and Educational Research Institute; and Classified Personnel Regional Officers.

The Employee Safety & Security Section is a new initiative of OHR under the direct supervision of the assistant superintendent.

Employee Safety & Security Section

Provides leadership, vision, and direction in the areas of Alcohol and Controlled Substances and Identity Theft.

- Develops and designs a coordinated DOE Alcohol and Controlled Substance program in accordance with federal and State laws, rules and regulations, collective bargaining agreements, Executive Orders, and other applicable requirements.
- Develops and designs policies, procedures, and guidelines on alcohol and controlled substances.
- Develops and designs the alcohol and controlled substances training program as well as educational materials and handbooks.
- Designs, implements, and administers an Identity Theft program in accordance with Chapters 487J, 487N, and 487R, Hawaii Revised Statutes.

- Administers and develops policies and procedures that support the department's compliance with Chapters 487J, 487N, and 487R, HRS.

The remaining groups are divided into three branches with each branch headed by a director, who is responsible for the operation and supervision of each group in the branch.

The Personnel Management Branch includes the Recruitment Section; Classification and Compensation Section; Records and Transactions Section; and the Certificated Personnel Regional Officers.

The Personnel Assistance Branch includes the Labor Relations Section; Negotiations Section; Workers Compensation, Health Benefits and Awards Section; Performance Management Section; and Human Resources Units.

The Personnel Development Branch includes the Training and Certification Section; Induction, Monitoring and Professional Development Section; Management Support Services Section; Professional Development and Educational Research Institute; and Classified Personnel Regional Officers.

PERSONNEL MANAGEMENT BRANCH

The Personnel Management Branch administers the recruitment process for the filling of vacant positions; processing of personnel actions for qualified applicants selected to fill position vacancies, as well as personnel actions for existing employees; and classification and compensation system for all positions.

Recruitment Section

- Plans and administers a recruitment program for all employees in the public school system: identifying and publicizing actual and anticipated vacancies; screens and refers, through applicant lists, qualified applicants for vacancies; provides guidance and procedures for interview and selection; interviews and/or coordinates teacher assessment evaluations; processes selected applicants for employment; and responds to related inquiries.
- Maintains and monitors web page used to market school personnel for department positions.
- Plans, develops, and administers the Temporary Contract Employee (TCE) Program.
- Plans and coordinates the assignment and transfer program for employees in the public school system.
- Administers Teacher Reclassification Program.
- Maintains teacher license area(s) of preparation file; maintains database of external administrators who possess a master's degree in Educational Administration and three years of teaching who are interested in seeking employment as an educational officer in the State of Hawaii.
- Administers, plans, develops, and coordinates the Part-Time Temporary (PTT) Teacher Program which includes the Casual Personnel System.

- Administers, plans, develops, and coordinates the teacher's Job Sharing Program, Early Return Program, and Hardship Transfer Program.
- Determines initial classification for substitute teacher applicants and reclassification of existing substitute teachers.
- Reviews and verifies all summer school hires on the Casual Personnel System.
- Maintains database for DOE Driver Education Certification and issues DOE Driver Training and Education Instructor Certificates.
- Maintains and trains a cadre of qualified interviewers to conduct interviews for all teacher applicants.
- Administers the Recruitment and Retention Program to provide qualified teachers and support staff for special education students by utilizing contracts such as Teacher-Teacher.com and Teach for America.
- Ensures contract provisions of recruitment agency's contracts regarding scope of services are appropriately monitored; ensures budget and allocation amounts are adequate for funding needs; revises contracts as necessary to clarify procedural requirements and/or changes in scope of services and compensation; ensures contract funds are appropriately spent; works toward building capacity for DOE to assume contracts responsibilities when contracts are terminated.
- Tracks and documents all implementation steps necessary to meet state benchmarks for activities relating to personnel recruitment.
- Administers and processes the hard-to-fill incentive for qualified special education teachers and regular education teachers in identified hard-to-fill schools.
- Administers and processes the incentive program for the return of qualified teachers who have dual certification to special education.
- Provides and monitors the relocation bonus for special education teachers who are recruited from the continental United States, based upon the time zone of the states.
- Processes Temporary Contract Employee forms for Administrative Workload Relief Program.
- Processes payment and compliance of requirements through casual payroll for the relocation bonus for special education teachers who are recruited from the continental United States, based upon the time zone of the states.
- Provides linkers to the Hawaii Teacher Standards Board for concerns related to teacher licensing.
- Coordinates job searches and placement for disabled employees with the Department of Human Resources Development, vocational rehabilitation counselors, and district and state offices.

Employee Background Check Unit

- Processes criminal history record checks and clearances for all employees, prospective employees, provider and subcontractors, and Institute of Higher Education (IHE) trainees.
- Coordinates exchange of highly confidential information with federal and state criminal and investigative agencies when processing classified information on prospective employees, providers and subcontractors and IHE trainees.
- Maintains a confidential, highly classified database on background information on all employees of the department.
- Processes temporary disability insurance claims for all employees of the department.

Highly Qualified Teacher Unit

- Build a system of capacity within each Complex Area to support non-highly qualified teachers.
- Provide training for Principals on highly qualified teacher requirements.
- Prepare and conduct statewide Teacher Outreach.
- Support, educate, and advise non-highly qualified teachers to become highly qualified.
- Review all new teacher records to determine highly qualified status for Title IIA of the No Child Left Behind Act.
- Monitor the status of all non-highly qualified teachers.

Classification & Compensation Section

- Administers, implements, monitors, and evaluates the establishment, reallocation, and abolishment of all DOE positions.
- Analyzes departmental classification problems and issues; develops program and operational procedures and practices for all DOE positions.
- Maintains a compensation plan consisting of all classes of work in the classification plan, indicating class titles and appropriate salary schedules.
- Maintains a library of civil service class specifications and minimum qualification requirements for DOE and other jurisdictions.
- Coordinates all amendments to the compensation plan with other jurisdictions to help assure the statutory provisions of equal pay are met.
- Conducts reviews to determine if labor shortages exist for classes of work or group of positions.
- Establishes a raised hiring rate or authorizes hiring above the minimum salary when a labor shortage is identified in order to better compete in the recruitment and fill of positions.

- Monitors statewide labor market conditions and participates in wage surveys.
- Conducts departmental classification studies and special projects; conducts on-site desk audit reviews of classified and Support Services Personnel (SSP) position duties as needed.
- Recommends the development of new and amended class specifications, including minimum qualification requirements; analyzes the scheme of classes for program improvement.
- Recommends bargaining unit designations.
- Provides management advisory services to departmental offices, district/complexes, line managers, and others; develops classification procedures and guidelines; provides technical assistance to others in their use and application.
- Represents the department in civil service classification appeals to the Merit Appeals Board (MAB).
- Develops and maintains a departmental classified position management system.
- Maintains position descriptions for all existing positions except for teachers and teacher-type positions.
- Conducts annual reviews of projected school lists to ensure all positions are properly identified and assigns position numbers for new positions for the upcoming school year.
- Maintains and establishes occupational group codes for all DOE positions.
- Under Weighted Student Formula (WSF) in accordance with each school's Academic Financial Plan (AFP), establishes/deletes positions beginning in May through February of the new school year. Also establishes/deletes/transfers Special Education, General Education Article VI positions in accordance with official student enrollment count and program needs.
- Conducts annual review of the principal and vice principal classification levels to ensure positions are properly classified by applying formulas to the official enrollment count.
- Supports the Classification/Compensation Appeals Board to review classification and compensation actions relating to educational officers.
- Administers the Educational Officer Recruitment Program which includes but is not limited to identifying and publicizing actual and anticipated vacancies (principals/vice-principals, 12-month internal, external, and Charter School administrators); administers the recruitment of non-DOE prospective school level administrative applicants – coordinates, screens, and refers applicants; coordinates interview and selection guidelines and responds to educational officer recruitment inquiries.
- Ensures that educational officer selection criteria, procedures, and compensation practices comply with federal and state laws, the School Code, and the bargaining contract, where applicable.

- Upon approval by the superintendent, processes the filling of temporary appointees to vacant educational officer positions and the filling of substitutes (retirees, external hires) to school-level educational officer vacancies.

Records & Transactions Section

- Administers the salary and compensation of all employees; certifies pay authorizations; and ensures that employees are paid properly and in a timely manner; maintains a personnel record and information system and the School List.
- Processes all personnel actions from initial appointment to separation for all employees during their employment with the department.
- Provides employment statistics and reports to comply with requirements of federal, state, and DOE equal employment opportunity and affirmative action programs; provides reports to the unions and legislature; provides employment verification; provides employee information as requested in accordance with State Office of Information Practices guidelines.
- Develops guidelines and procedures to ensure that personnel transactions are processed in accordance with applicable personnel rules and regulations, collective bargaining provisions, and departmental regulations and procedures.
- Provides technical guidance, support, and assistance to departmental administrators, supervisors, managers, and staff regarding personnel matters.
- Provides technical support and assistance for ensuring compliance with federal laws such as the Fair Labor Standards Act, the Immigration Reform and Control Act, the Drug-Free Workplace Act, and the Americans with Disabilities Act.
- Plans and administers a records program, including computerized master files for public school teachers. Maintains employee information in the department's computerized personnel systems.
- Administers the DOE Leave Sharing Program.
- Implements and administers coach's compensation through the Casual Personnel System.
- Maintains data file on employee bonus and incentives.
- Supports the teacher stipends program, Early Returns and Hardship Transfers for teachers, and the annual Teacher Transfer Program.

Substitutes Unit

- Administers the program to report the hiring and compensation of substitute and casual employment.
- Administers the program for substitute teachers (maintains and monitors TSEAS System).
- Prepares Columbus billing data for use of substitute teachers.

Certificated Personnel Regional Officers

Personnel Regional Offices provide employment and personnel administration services to schools, complexes, and districts, within the framework of established laws, policies and accepted principles of personnel management. The scope of the services provided by the Personnel Regional Offices include:

- Recruitment, selection, and employment processing
- Certification of teachers and educational officers
- Leave administration
- Personnel resource accounting and position allocation
- Interpretation and implementation of personnel policies and procedures
- Training of school administrators
- Employee awards and recognition
- Criminal history checks
- Employee grievances
- Conduct investigations and provide advisement
- Teacher induction and mentoring programs
- Onsite personnel liaison to the complex area superintendent(s)
- Contract implementation and interpretation
- Employee benefits
- Classification and compensation
- Fair labor practices and EEO
- Employee evaluation system
- Workers compensation program
- Substitute employees and casual hires

Personnel Regional Offices foster and maintain positive working relationships between the DOE, unions, and other agencies.

PERSONNEL ASSISTANCE BRANCH

The Personnel Assistance Branch comprises the following sections, with its respective functions: Labor Relations Section, which administers the employee grievance/arbitration program; Negotiations Section, which oversees collective bargaining negotiations and contract interpretations and consult and confer; WC, Health Benefits and Awards Section, which oversees workers compensation, certain health benefit plans, certain awards, and certain other employee benefits (e.g. tax-sheltered annuities, liaisons to provide benefit information, etc.); Performance Management Section, which develops and implements a workers performance system; and Human Resources Units, which provide direct personnel services to Complex Areas and schools.

Labor Relations Section

- Administers the employee grievance/arbitration program, which includes processing employee/union grievances; provides advisory services and coordination of grievance hearings at the various levels; serves as the department advocate in grievance and arbitration cases; maintains a system of grievance recordkeeping and accountability; and conducts workshops for first-line supervisors and middle-management personnel on the processing of employee grievances and contract administration.
- Plans and administers the contract administration, compliance and monitoring program for the public school system.

- Serves as liaison between the public school system and various unions on employer-employee matters as required by state statutes and/or collective bargaining agreements.
- Provides guidance in the processing of employee disciplinary actions, non-renewal of employee contracts and termination of employment for disciplinary reasons, maintaining a system of recordkeeping and accountability for adverse disciplinary actions; and conducts workshops for first-line supervisors and middle-management personnel in the processing of adverse disciplinary actions.
- Fosters and maintains positive and cooperative working relationships with the unions.
- Coordinates Release Time requests for bargaining unit representation by the Hawaii Government Employees Association, Hawaii State Teachers Association, and the United Public Workers.
- Assists and advises as required regarding investigations and fact-finding related to allegations of employee misconduct.

Performance Management Section

- Develops and implements a worker performance system that links evaluations, timely and appropriate prescriptive professional development, and incentives to support quality workers.
- Develops and maintains the profiles or standards for teachers and administrators.

Negotiations Section

- Provides research, technical information, staff support, and facilitation assistance to the negotiations teams and spokespersons for teachers and educational officers; may also serve as spokesperson.
- Provides research, technical information, and staff support to the negotiations teams for the classified bargaining units (Units 1, 2, 3, 4, 9, 10, and 13).
- Assesses the effectiveness of operations and procedures in relation to future negotiations.
- Coordinates the preparation of the initial intent and new contract language interpretation for teachers and educational officers.
- Provides staff assistance and maintains records and files on collective bargaining and negotiations, as mandated by the legislature or negotiated agreements, such as Labor Management Cooperation Committee, Grievance Protocol Committee, and Labor Relations Committee.
- Maintains liaison between the Board of Education and other state agencies in collective bargaining and negotiations matters, e.g., assisting in coordinating the preparation of memoranda of understanding necessary to implement new provisions of negotiated agreements; and assisting other state agencies on collective bargaining matters relating to collective bargaining units and employees.

- Advises the BOE members serving on the respective School Community Councils (SSC) Exception Review Committees for Bargaining Unit 5 and Bargaining Unit 6 on issues relating to requests for contract exceptions.
- Coordinates, monitors, and maintains the Consult and Confer process and all communication to the Union as part of that process.
- Maintains the School Code/Standard Practices on personnel policies, regulations and procedures as provided for by the Board of Education and state statutes which include recommending revisions to conform to the provisions of negotiated contracts to the Board of Education and providing interpretations of approved School Code/Standard Practices provisions.

WC, Health Benefits and Awards Section

Workers' Compensation (WC) Unit

- Plans and administers the WC Program for all employees, and students and adult volunteers that are providing services to the department.
- Determines eligibility for WC benefits.
- Processes WC claims and pays for WC benefits as required by WC law.
- Monitors WC activities for effectiveness and efficiency.
- Represents the DOE at Department of Labor and Industrial Relations (DLIR) – Disability Compensation Division hearings.
- Provides staff support to the staff of the Department of the Attorney General on matters relating to appeals at the DLIR – Labor Appeals Board and third-party liability claims.
- Assists with returning claimants back to work as soon as possible and refers claimants to the Return-to-Work Priority Program.
- Ensures compliance with applicable WC laws, related administrative rules, and DOE policies and procedures.
- Plans and administers certain bloodborne pathogens activities for the DOE as follows:
 - Provides and coordinates Hepatitis B vaccinations for all qualified DOE employees.
 - Provides access to bloodborne pathogens training information involving universal precautions.
 - Processes and pays for medical costs related to post-exposure evaluation and follow-up for DOE employees who are exposed to bloodborne pathogens while performing work-related tasks.

Health Benefits and Awards Unit

- Assists with the administering of health benefits plans offered by the Hawaii Employer-Union Health Benefits Trust Fund (EUTF). Works with the HSTA VEBA Trust Fund for Bargaining Unit 05/45 employees.
- Administers the Tax Shelter Annuity 403(b) Program for eligible employees in the department.

- Coordinates Service (10, 20, 30, 40 and 50 years) and the Retirement Awards for eligible employees.
- Coordinates certain other awards programs for employees of the Department to include Teacher of the Year, Employee of the Year (Sustained Superior Performance Award), Certificate of Achievement, Team Excellence Award of Merit (TEAM), Teacher in Residence Program, and international exchange programs.
- Liaison between the Department and other State agencies (ERS, EUTF, DHRD, etc.) to provide information and updates to all employees related to the State's Deferred Compensation Program (DC 001), PTS Deferred Compensation Retirement Plan (DC 015), Island Flex Flexible Spending Accounts Program, Premium Conversion Plan and the ERS program.
- Works with the Payroll Section to provide information and updates on the Department's Post-Separation Vacation Pay Deferral Program.

Human Resources Units

The Human Resources Units provide direct personnel services to Complex Areas and schools with respective functions in:

- Recruitment.
- Criminal history checks.
- Labor relations contract administration.
- Employee relations and services.

PERSONNEL DEVELOPMENT BRANCH

The Personnel Development Branch administers training and certification of educational assistants, special education teachers, and support services personnel to teachers and speech pathologists; employee evaluation program; sabbatical leaves; employee awards; compliance and monitoring of federal and state requirements, such as the Felix consent decree and No Child Left Behind; maintenance and updates of the departmental organizational charts and functional statements; review of proposed reorganizations; legislation coordination, budget/fiscal oversight, and procurement contracts for OHR; maintenance of various databases to support personnel decision making; and establishment/tracking of OHR performance measures.

Training & Certification Section

Para Educator Career Ladder Training Program – this program provides comprehensive, systematic, competency-based training to educational assistants (EA) and other support service personnel to increase their knowledge and skills to improve their performance in the classroom. The training includes in-service workshops to schools, professional development courses, and career ladder opportunities. This program also assists paraprofessionals to prepare for the state test of competency that satisfies No Child Left Behind (NCLB) highly qualified requirements.

- Designs, develops and implements training programs for paraprofessionals.

- Develops and writes Instructional Modules for EA orientation, immediate and advanced courses.
- Develops, writes and implements in-service and workshop modules for complex waiver days and other school requests which address specific issues faced by paraprofessionals.
- Designs and develops formative and summative evaluation plans for paraprofessional training.
- Observes and assesses classroom performance.
- Coordinates trailing and career ladder opportunities with community school for adults, community colleges and universities.
- Trains EAs in literacy tutoring and math tutoring.
- Provides information and training to high school students interested in pursuing a career in education.
- Conducts informational meetings to recruit paraprofessionals into the Chaminade Dual Certification in Teaching Program and Leeward Community College's Associate of Arts in Teaching Programs.
- Prepares bi-monthly newsletter for distribution to all paraprofessionals.
- Creates, copies and distributes flyers, posters, memos regarding professional development opportunities.
- Coordinates information with TIES for Para Educator website.

Alternative Route to Licensure in Special Education (ARLISE) – provides non-licensed special education teachers with an opportunity to teach in the classroom while earning special education licensure.

- Recruits, registers, and enrolls teacher candidates statewide into the ARLISE Program.
- Conducts research on latest research-based instructional practices and incorporates it into program curriculum and instruction.
- Develops instructional modules that meet national and state competency and content standards.
- Implements instructional modules via seminar and on-line coursework.
- Conducts classroom performance measurement via on-the-job assessment of teaching behaviors.
- Conducts individual conferences with teachers to provide feedback on classroom teaching performance.
- Conducts conferences with principals to coordinate teacher progress through the licensure program.
- Tracks progress of teachers in their progress towards graduation and stores data for accountability analyses.

- Prepares formative and summative evaluation reports of the ARLISE Program.
- Provides counseling and resources to help teachers meet program requirements.
- Prepares documentation for state approval of teacher education (SATE) program review.
- Meets with partnering universities (City University, Bellevue Washington and Chaminade University in Honolulu) to coordinate program instruction.
- Provides personnel managers with graduate data to update the HDOE personnel file.

Bachelor of Arts in Special Education (BASE) – serves as the City University (Bellevue Washington) operations center in Hawaii to assist teacher candidates in completing all requirements toward graduation and licensure as special education teachers.

- Recruits, registers and enrolls teacher candidates statewide into the BASE Program.
- Hires and pays instructors.
- Hires and pays evaluators for student teaching.
- Procures and arranges for instructional facilities.
- Provides text information and course materials to students.
- Tracks progress of students in their progress toward graduation and stores data for accountability analyses including terms and conditions of tuition stipend agreement.
- Provides counseling and resources to help students meet program requirements.
- Prepares documentation for SATE program review.
- Conducts periodic reviews for City University staff from Bellevue, WA.

Technology Integration & Evaluation Unit

- Provides data collection, analyses, and reporting.
- Creates web-accessed databases that store performance measures, grades, and program status data from the center's alternative licensure programs.
- Analyzes training data to determine the degree of success of training programs in meeting program objectives.
- Provides program managers with formative evaluation data and results that assist them in improving training programs to meet planned benchmarks.

- Provides program managers with summative evaluation data and results that assist them in determining the degree of success of training program and whether or not the programs should be continued or stopped.
- Provides personnel managers with program graduates' retention rates.
- Provides Center staff and trainers with office equipment, computers, distance learning equipment, telecommunication capabilities, internet access, and e-mail capability.
- Provides systematic training in technology use.

Induction, Monitoring & Professional Development Section

The Induction/Professional Development Section supports all teachers in building their teaching capacity, relative to the Hawaii State Teaching Standards and No Child Left Behind requirements, in addressing the needs of a diverse student population and building a support network that includes professional dialogue among teachers. The section is involved in the development of a comprehensive Induction Program that will provide beginning teachers with supports based on a performance-based assessment that will ultimately lead to increased student achievement. Licensure and re-licensure requirement supports are addressed through ongoing workshops. Professional development activities and opportunities are provided throughout the year to enable all teachers to meet and exceed professional teaching standards.

Services and activities:

- Provides various training in partnership with New Teacher Center University of California Santa Cruz and University of Hawaii Special Education Department that focus on the development of a comprehensive induction program (i.e. mentor training, administrator training, induction institute, formative assessment system for beginning teachers).
- Coordinates and collaborates with various complexes in developing and/or enhancing their induction program.
- Provides additional beginning teacher supports with district/complex area support providers and administrators specifically in the area of Special Education.
- Collects data on mentoring support e.g. New Teacher Center Online Survey.
- Pilots an Induction Program in Maui.
- Provides Praxis Prep workshops. Math: Oahu, Big Island, Kauai, and Maui. Reading and writing on Oahu only.
- Aligns the Hawaii Teacher Standards, PEP-T to a national continuum of teacher professional development.
- Develops and expands online and live courses aligned to continuum.
- Conducts live professional development courses on the islands of Hawaii, Maui, and Oahu during the fall, spring, and summer semesters.

- Provides and facilitates professional development online courses that are accessible to teachers across the state.
- Develops professional development program plans based on Leadership Development & Educational Research Institute (LDERI) guidelines.
- Develops professional development courses (modules, activities, handouts, assignments).
- Submits professional development courses to LDERI for approval.
- Posts professional development activities on the DOE Learning Catalog.
- Updates and posts courses on RRSC, personnel support section website.
- Creates and disseminates course and workshop flyers.
- Secures facilities and equipment for courses.
- Coordinates online logistics with Webed (threaded discussions, access codes, log on instructions).
- Develops training packet and trains contracted course instructors.
- Provides feedback to course participants on course content application through class visitations and review of their learning portfolio.
- Develops and conducts inservice/workshops/training based on area needs and requests.
- Collects money to purchase course materials.

Management Support Services Section

- Reviews, analyzes, and recommends reorganization proposals based on sound organization principles and in compliance with the governor's administrative directive.
- Publishes and maintains the department's official Plan of Organization; coordinates the annual update.
- Monitors the Title II NCLB Grant for teacher and administrator quality; monitors other federal grants as needed.
- Serves as liaison between the department and agencies to ensure correct and proper communication in the implementation of compliance activities.
- Assists the branch with coordination of legislative bills.
- Provides budget and fiscal oversight for OHR.
- Establishes and monitors OHR performance measures.
- Assists the branch with compliance to procurement requirements.

Professional Development & Educational Research Institute

This section is responsible for program leadership for and coordination of all activities related to professional development for teachers, administrators, and educational officers.

- Researches and shares information regarding best practices related to instruction and school leadership.
- Provides coordination necessary to develop and implement an integrated professional development program.
- Supports teacher leaders and administrators with overall leadership development, mentoring and support.
- Designs and conducts the training sessions for the Teacher Leader Academy, ACE Program, Hawaii Principals Academy, and Superintendent's Academy.
- Conducts and participates in focus groups and forums related to leadership.
- Plans, develops, conducts, and administers the school administration training program for the screening, training, and certification of school administrators.
- Develops partnerships with the universities in support of administrator training.
- Provides registration for the employee training programs sponsored by the Department of Education.

Classified Personnel Regional Officers

Personnel Regional Offices provide employment and personnel administration services to schools, complexes and districts, within the framework of established laws, policies and accepted principles of personnel management. The scope of the services provided by the Personnel Regional Offices include:

- Recruitment, selection, and employment processing
- Return to work priority program
- Leave administration
- Personnel resource accounting and position allocation
- Employee awards and recognition
- Criminal history checks
- Employee grievances
- Employee benefits
- Contract Implementation
- Classification and compensation
- Fair labor practices and EEO
- Employee evaluation system
- Workers compensation program
- Substitute employees and casual hires

Personnel Regional Offices foster and maintain positive working relationships between the DOE, unions, and other agencies.

3. OFFICE OF INFORMATION TECHNOLOGY SERVICES

The Office of Information Technology Services (OITS) exercises technical oversight of information and telecommunication systems, facilities, and services of the public school system and department-wide operations to ensure that information technology and telecommunications support are being provided efficiently and effectively, and in accordance with laws, policies, and accepted principles of management. The scope of OITS' technical oversight includes voice, data, video, information systems infrastructure, and support services for schools and for complex areas and state administrative offices. Support services to schools are exercised in collaboration with the complex area superintendent. OITS provides the public school system with leadership and support in the management and use of information, telecommunication, instructional technologies and related resources; develops strategic plans, policies, procedures, and standards for information and telecommunication services; plans and maintains the information and telecommunication systems infrastructure, local networking, and statewide connectivity to permit rapid adaptation to new directions and to limit the risk of obsolescence in meeting the needs for voice, video, and data communication; manages information, telecommunication, instructional technologies, and related resources; provides training and technical support in use of voice, video, data, and information systems; and provides direct consultative services to schools through the assignment of staff to school sites. Under the direction of the assistant superintendent, Office of Information Technology Services, these functions are provided by three OITS branches: Information System Services Branch, Information Resource Management Branch, and Network Support Services Branch.

INFORMATION RESOURCE MANAGEMENT BRANCH

The Information Resource Management Branch develops policies, procedures, and guidelines relating to information resource management, coordinates the development of operational plans for the information systems and services of the public school system, and provides information technology support services for various department-wide computer applications.

Student Information Services Section

This section is the planning focal point for the department's policies, procedures, standards, and guidelines with respect to student information systems and services. The section also provides operational support to users of the student information system and services.

- Develops and maintains policies, procedures, standards, and guidelines to ensure quality processing, communication, and dissemination of student information and data.
- Provides technical consultation in planning and developing new or enhanced student information systems in order to ensure long-term compatibility and usability of information and data.
- Provides data control services for student accounting, federal impact aid survey, grade reporting, scheduling, attendance, and other student information-related functions.
- Conducts the federal impact aid survey.
- Provides logistical services for statewide testing programs.

- Provides the interface between users and technical staff in the operations of the student information system.
- Provides and maintains a help desk for users.

Information Access Support Section

This section administers the department's record management program.

- Plans, coordinates, and develops procedures and guidelines for access to personally identifiable records within the department.
- Serves as the department's liaison with the Office of Information Practices.
- Plans and coordinates the microfilming of student records, including providing consultative services to school staff on preparing the records for microfilming.
- In consultation with the DAGS records management program staff, develops and maintains the retention schedule for department unique records.
- Manages and administers the administrative rule regarding the educational rights and privacy of students and parents.
- Manages and administers the administrative rule regarding geographic exceptions.

Lotus Notes Support Section

This section has functional and user support responsibilities for developing and maintaining the Lotus Notes groupware that is the backbone of the department's electronic communication and dissemination system.

- Analyzes the business processes considered for incorporation as a function of the groupware.
- Plans and designs system-wide functional enhancements to the department's Lotus Notes groupware based on business process analysis.
- Provides design and overall direction to the technical staff on the programming of enhancements or new uses for the groupware.
- Plans and coordinates the implementation of enhancements or new uses department-wide.
- Provides consultative design services to schools and offices to meet their customized functional needs.
- Provides training of users on various Lotus Notes applications.
- Provides help desk support to users.
- Creates and maintains user accounts and access levels.

Information Management Architecture Section

This section coordinates the department's cross-functional information

management (IM) activities. It ensures that IM activities provide the department personnel with access to data in a useful format when and where needed, data that is accurate and consistent, and is shared across the organization.

- Develops and maintains the department's information management strategy. This includes:
 - Developing and adapting the department's information management architecture according to evolving departmental information needs;
 - Ensuring that the department's technical and application systems are aligned with the IM architecture and direction.
- Provides information support to state and district offices on data modeling and statistical analysis based on programmatic issues. This includes:
 - Evaluating information requirements and ensuring IM/IT efforts are aligned with the intent of the needs; and
 - Coordinating IM activities between OITS and other DOE offices or external agencies.
- Administers and conducts statistical research and analysis. This includes:
 - Disseminating yearly and ad-hoc reports such as student enrollment projections; enrollment counts; student attendance; student transfer, withdrawal and retention; demographic, population, and socioeconomic characteristics of school attendance areas; and other applications and analyses of school and student data as required;
 - Coordinating and managing the collection and retrieval of student information and other types of data to respond to requests from federal and state agencies and the public;
 - Serving as the liaison to the National Center for Education Statistics (NCES) on state-national data issues; and
 - Providing functional planning, modeling, and content support for the department's decision support system.

Student Services Application Section

This section provides support for the development, maintenance, and user training for the department-wide computerized application (eCSSS) that tracks and manages services to students.

- Assists in the analysis of the business process involved in the student services that is considered for computerization.
- Assists in the development of user requirements.
- Provides and maintains a help desk for users.
- Provides the interface between users and technical staff in the operations of student services applications. This includes conducting initial troubleshooting of user problems, and where needed, working with technical staff to resolve problems.
- Assists in the planning and coordination of the implementation of new student services applications or enhancements of existing ones.

- Provides training and other support to users in using various student services applications.
- Evaluates the operations of various student services computer systems.

Information Systems Training Section

This section plans, coordinates, administers, and implements a department-wide education and training program on information processing and telecommunication systems and services to continually develop the knowledge and skills of administrators, professional and technical staff, and clerical personnel to efficiently and effectively use department-wide application systems, end-user hardware and software, and telecommunication networks. The section researches and obtains access to databases developed and maintained by federal and other state agencies, universities, research institutes, and commercial sources which meet the information and data needs of schools and offices. It provides training to end users in methods and procedures of accessing on-line information resources. The section is also responsible for the development and implementation of the DOE'S Centralized Service Desk (CSD).

- Develops and provides a regular program of workshops and seminars for end users in the methods and processes of accessing on-line information resources, and responds to requests for specific user groups for such training.
- In coordination with the Information System Services Branch and other state program offices that have primary responsibility for various application systems, assesses training needs, and develops, conducts, and evaluates training courses to ensure reliable implementation and operation of department-wide application systems.
- In consultation with schools and offices, assesses education and training needs, and develops and coordinates an end-user training program to develop knowledge and skills in the use and application of microcomputers, office automation products, electronic mail and other communication hardware and systems in their administrative and educational operations.
- Plans, develops, and administers other education and training activities to upgrade the level of knowledge of department administrators, and to expand the technical competencies of information processing and communications professionals in OITS.
- Coordinates educational activities and training programs with other training resources of the department, other agencies, vendors, and consultants.
- In consultation with various offices and vendors, plans and manages the development and implementation of the DOE's CSD.

INFORMATION SYSTEM SERVICES BRANCH

The Information System Services Branch develops, integrates, and maintains DOE statewide computer-based application systems on the department's multi-user host computers and servers, as well as the Department of Accounting and General Services' (DAGS) mainframe computers. In addition, the branch develops and maintains specialized application systems such as the automated

substitute teacher assignment system, Workers' Compensation system, TSA vendor database, Driver's Education database, etc. When resources allow, ISSB also develops web-sites for offices that request this service. This branch is headed by a director and technically supported by two project management specialists, two technology integration specialists, and a clerical staff consisting of a secretary and a clerk for the Honolulu location, and a secretary and clerk at the Kapolei location.

School and Student System Development Section

This section provides systems development, enhancement, and maintenance support for the department's school and student information processing systems.

- Provides system and database management, system analysis, analysis of hardware and software alternatives, and programming support for the development and installation of new application systems for information processing.
- Participates with the Network Support Services Branch in planning the installation of necessary data communications networks prior to implementing new application systems.
- Provides enhancement and maintenance support for existing local and statewide application systems to meet user requirements and implement new or revised system software and hardware.
- Develops documentation required to operate, maintain, and utilize computer-based application systems, and provides technical assistance in user training on new application systems.
- Plans and designs the databases for statewide school application systems.
- Manages physical database structures and program libraries, and performs daily monitoring of all databases to detect and correct conditions that may lead to database degradation.
- Provides technical support in resolving computer hardware and software, as well as data communication problems.
- Assists in the technical evaluation and acquisition of new hardware and software tools to facilitate the development and enhancement of application systems.
- Provides assistance in the preparation of technical specifications for bids and contracts relating to computer hardware, software, and related services, and participates in the selection process.

Personnel and Payroll System Development Section

This section provides systems development, enhancement, and maintenance support for the department's personnel and payroll information processing systems.

- Provides system and database management, system analysis, analysis of hardware and software alternatives, and programming support for the development and installation of new application systems for information processing.

- Participates with the Network Support Services Branch in planning the installation of necessary data communications networks prior to implementing new application systems.
- Participates with contractors, users, and other state departments as well as other organizations in defining requirements and providing modifications and enhancements to existing local and statewide application systems.
- Develops user manuals required to utilize computer-based application systems and system and programming documentation to operate, enhance and maintain these systems. Also provides technical assistance during user training on new application systems.
- Plans and designs the databases for application systems.
- Manages personnel database structures and program libraries, and performs database administration (DBA) functions that include daily monitoring of all database relations to detect and correct conditions that may lead to database corruption.
- Provides technical support in resolving computer hardware, software, and data communication problems.
- Assists in the technical evaluation and testing of new hardware and software tools to facilitate the development and enhancement of personnel and payroll application systems.
- Provides assistance in the preparation of technical specifications for bids and contracts related to computer hardware, software, and related services.

Desktop and Server Application Development Section

This section provides systems development, enhancement, and maintenance support of systems that supplement the department's statewide information processing systems. This section also provides operating system support and server administration for other branch projects.

- Provides system and application support for Workers' Compensation system, including software/hardware/network infrastructure, server administration, database administration, security policies, system enhancement, user technical support, and integration with other DOE systems such as FMS.
- Provides system and database management, system analysis, analysis of hardware and software alternatives, and programming support for the development and installation of the Hawaii State Test for Essential Competencies (HSTEC).
- Designs, implements, and provides system administration for internal networked servers which support infrastructure for this branch's daily operations as well as other local and statewide applications.
- Assists with the Network Support Services Branch in performing installation of necessary data communication networks in offices located in the Liliuokalani Building.

- Provides enhancement and maintenance support for existing local and statewide application systems such as HSTEC, the Workers' Compensation record keeping system, Driver's Education system, T-SEAS, student suspensions, etc.
- Develops documentation required to use, operate, maintain, and enhance various computer-based application systems and provides technical assistance in user training on new application systems.
- Plans and designs the databases for application systems.
- Maintains the integrity of the physical database structures and program libraries by performing regular monitoring and evaluation operations.
- Provides technical support in resolving computer hardware and software problems, as well as data communication problems.
- Provides assistance to state and district offices in setting up, configuring, and trouble-shooting of hardware and software.
- Assists in the technical evaluation and acquisition of new hardware and software tools that would facilitate development and enhancement of systems.

Budget Systems and Special Application Development Section

This section provides systems development, enhancement, and maintenance support for the department's Budget Preparation and Budget Execution systems, as well as special applications such as the casual employee Time and Attendance system.

- Provides system and database management, system analysis, analysis of hardware and software alternatives, and programming support for the development and enhancement of new budget, casual employee time and attendance, and other application systems.
- Participates with the Network Support Services Branch in planning the installation of necessary data communications networks prior to implementing new application systems.
- Provides enhancement and maintenance support for statewide budget application systems to meet the budget director's and budget analysts' requirements, and also requirements from the legislature and the Budget and Accounting Office's requirements.
- Develops documentation required to use, operate, and maintain the Budget Preparation and Budget Execution computer-based application systems and provides technical assistance in user training on new budget application systems.
- Develops casual employee Time and Attendance system user manuals for distribution to all schools and offices. Provides technical assistance and user training to the user support technicians on new casual employee and other application systems.
- Develops documentation required to use, operate, and maintain casual employee Time and Attendance computer-based application systems. Develops programming documentation to operate, enhance, and maintain these systems.

- Plans and designs the databases for budget, casual employee Time and Attendance, and other application systems.
- Manages physical database structures and program libraries, and performs regular checks of all databases to detect and correct conditions that may undermine the integrity of these databases.
- Provides technical support in resolving budget, casual employee Time and Attendance, and other application related computer hardware and software, as well as data communication problems.
- Assists in the technical evaluation and acquisition of new hardware and software tools to facilitate the development and enhancement of application systems.

FMS Workstation and Web Services System Development Section

This section provides systems development, enhancement, and maintenance support for the client-level software which runs on the FMS workstation at each school and office, and provides the user interface to the department's financial management systems.

- Performs system analysis, analysis of hardware and software alternatives, programming support for the maintenance and enhancement to the financial management system, and other administrative data systems.
- Participates with the Network Support Services Branch in planning the installation of necessary data communications infrastructure in support of improved versions of financial management and other systems.
- Defines requirements for computer-based applications to meet new or changing departmental business processes.
- Develops user documentation required to utilize, operate, enhance, and maintain these computer-based application systems. Also provides technical assistance in user training on new application systems.
- Plans and designs the databases for application systems.
- Provides technical support in resolving computer hardware, software, and data communication problems.
- Performs technical evaluation and testing of new hardware and software tools to facilitate the enhancement of the department-wide financial management systems and other administrative data systems.
- Applies web-services technologies to create web-based computer applications and associated data bases for financial and other administrative needs.

FMS Mainframe System Development Section

This section provides systems development, enhancement, and maintenance support for the department's primary financial systems which includes purchase order processing, payment processing, fixed assets, general ledger, cash receipts, and other accounting functions residing on a mainframe computer. In addition, the section provides enhancement and support of the local school fund accounting system which is used by all schools to keep records of non-appropriated funds.

- Provides system and database management, system analysis, analysis of hardware and software alternatives, and programming support for the maintenance and enhancement to the financial management system.
- Participates with the Network Support Services Branch in planning the installation of necessary data communications infrastructure in support of the financial management systems.
- Participates with contractors and users in defining requirements and providing enhancements to existing local and statewide application systems to meet user requirements and implement revised system software and hardware.
- Develops user manuals required to utilize, operate, enhance, and maintain these computer-based application systems. Also provides technical assistance in user training on new application systems.
- Plans and designs the databases for application systems.
- Manages the financial system DB2 database structure and program libraries, and performs database administration (DBA) functions that include daily monitoring of all database relations to detect and correct conditions that may otherwise lead to database corruption.
- Provides technical support in resolving computer hardware, software, and data communication problems.
- Performs technical evaluation and testing of new hardware and software tools to facilitate the enhancement of the department-wide financial management systems.

Decision Support and Data Warehouse System Development Section

This section provides requirements definition, system design, development, maintenance, operation, and support of decision support applications and associated integrated data bases. These applications transform and integrate data from the department's operational data systems into an integrated data structure optimized for on-line analysis. They also provide associated user tools to summarize or drill-down, aggregate or disaggregate, and produce results in either tabular or graphic forms, referred to as "business intelligence."

- Defines departmental requirements for decision support, business intelligence applications.
- Applies Data Warehouse and other technologies to meet departmental needs.
- Designs and implements data bases to integrate data from the department's operational systems.
- Designs and implements supplementary data structures (multi-dimensional cubes) to provide responsive on-line analysis.
- Develops extract, transformation and load processes to extract data from the various operational systems, transform and eliminate irregularities as necessary, and load the data into an integrated data base.

Defines and implements user interface and data display applications to provide users the tools to interact with the data.

Lotus Notes Application Development and System Management Section

This section provides application development for schools and offices using the Lotus Notes platform, system management and administration of the distributed, multi-server Notes infrastructure, and system administration of Lotus Notes electronic mail system used for official administrative communications department-wide.

- Manages the DOE-wide Notes distributed server infrastructure.
- Performs system administration of all Notes servers. Defines and implements the Notes data architecture including both logical and physical file structures.
- Defines, configures, and implements server data replication and data backup policies.
- Designs, develops, and supports collaborative computer applications for schools and offices utilizing the Lotus Notes application development environment and associated programming languages.
- Designs, develops, and supports administrative computer applications that require workflow processes for schools and offices, utilizing the Lotus Notes application development environment and associated programming languages.
- Manages the Lotus Notes electronic mail statewide system, including user-level and organizational-level security certificates, mail accounts, and web access.

NETWORK SUPPORT SERVICES BRANCH

The Network Support Services Branch plans, develops the department's statewide telecommunications network architecture, infrastructure, and operational plans including strategic, long-range planning, policies and standards. The branch plans, designs, installs, and operates the department's telecommunication network for data, video, and voice. The branch plans, installs, and maintains the school local telecommunication networks and supports operating of the networked resources at schools and offices. The branch provides direction and guidance in development of technology plans for the schools, participates in developing standards and evaluation for the department's technology adoption and implementation for instructional and administrative functions. The branch plans, installs, and operates the department's enterprise-wide systems for statewide access and utilization of instructional and administrative uses by all schools and offices.

Network and Computer System Operations Section

This section manages the operation of the department's telecommunication systems and the host and distributed computer systems.

- Manages operations of enterprise computer host and distributed servers for administrative and instructional uses, including servers for network access and protection, and the storage area network systems.
- Develops and implements procedures and safeguards against unauthorized access to departmental systems and networks, and

manages and grants user authorization to access application systems and data.

- Plans and implements disaster recovery plans in cooperation with the other state agencies and department's offices.
- Plans, installs, and manages the network and computer access and security servers such as firewall server, intrusion detection server, Internet filtering server, anti-virus server, Internet cache server, load balancing server, etc. Monitors the network access for security, and coordinates security management with other sections in the branch and other offices in the division.
- Analyzes usage and performance data to monitor and optimize the capacity and effectiveness of the department's host and distributed computer systems and plans for their expansion.
- Works with services/system providers and end users in the resolution of problems involving the department's network and computer systems.
- Plans, coordinates, and schedules with the Information and Communication Systems Division (ICSD) of the state Department of Accounting and General Services for the access and use of their computer resources and services.
- Installs and maintains operating system, database management, networking, and system utility software for the department's host and distributed computer systems.
- Prepares bid specifications for planned resources and acquires and installs major computer hardware and software.
- Monitors the operation of the department's wide area data network (WAN) and the local area data networks participating in the department's WAN. Coordinates activities to correct any WAN malfunctions with the Wide Area Network Management Section.
- Provides the first one of user support in access and use of the telecommunication network, networked computer resources and applications.
- Manages system resources, including the allocation of data storage resources, storage area network resources for the department's host and distributed computer systems.
- Plans and manages the computer data backup library and the safekeeping of data files through appropriate backup systems and off-site storage.

Wide Area Network Management Section

This section provides engineering, planning, installing and operating of the WAN that connects the school networks to the global network through WAN technologies.

- Determines requirements for WAN to support information technology infrastructure including data, image, and video communication systems in coordination with other state agencies, other offices in the department, and the schools.

- Manages installation and upgrade of the department's WAN for data, and video for remote school/office sites and central communications center sites in accordance with school technology requirements, industry standards, and department's plans/requirements.
- Manages daily operations of the WAN for data and video, manages telecommunication network services provided by telecommunications service providers and WAN hardware/software vendors.
- Plans and manages performance of Internet backbone access network through the commercial network service provider and manages network access to Internet II through the University of Hawaii.
- Schedules and monitors the operations of statewide data, image, and video communication systems to optimize the use of available telecommunication resources. Monitors network performance of the WAN through the network management systems and takes appropriate action to provide network capacity required by various applications for the schools and offices.
- Plans, installs, and supports internetworking connections between the school local area network (LAN) and the WAN for schools' access to the Internet and the Intranet, sets up and supports Internet services such as NAT, DHCP, DNS, Network Security System, Network Management System, etc.
- Plans and coordinates with other state agencies to implement and expand/upgrade the statewide backbone network, such as the state's institutional network (I-Net) to support data, video, and voice communication requirements for the department. Manages and operates the department's part of the I-Net to provide high capacity network connections.
- Evaluates WAN telecommunications hardware, software, and services. Develops specifications for competitive bidding and participates in evaluation of bids and selection of appropriate vendors and network transport service providers.
- Researches, analyzes, and assesses the applicability of the advances in WAN telecommunication technologies and services to stay abreast of major trends and potential applications for improving the department's WAN.
- Manages Internet resources such as IP addresses, autonomous system number for the department. Allocates IP addresses to schools and offices. Designs, plans, and operates IP (public and private) assignment scheme to the schools and offices.
- Reviews and approves all requests for data, image, and video telecommunication network and services.

School Local Network Operations Support Section

This section provides support in the area of installation, administration, and management of the Network Operating Systems (NOS) for schools and offices; and provides support in management and use of the networked resources effectively and efficiently.

- Provides technical consultation and support in planning, designing, implementing, and operating the NOS and networked applications of the schools operating in the school LAN, across the department's WAN and Internet.
- Develops and proposes budget requirements for future network projects according to school-identified priorities and technology plans. Assists schools in the selection and purchase of equipment and software necessary to implement and maintain their technology projects.
- Determines the NOS requirements for the school, provides support in selection and procurement of the NOS that meets the requirements of planned or existing applications. Configures and installs NOS with the school technology personnel.
- Provides training for the school technology personnel in administration and operation of the NOS installed, trains the users in the efficient use and management of network applications.
- Provides phone support and on-site technical problem resolution on school LANs as necessary. Provides remote management and diagnosis of the school NOS and LAN operations as necessary.

School Technology and Telecommunication Network Support Section

This section provides schools with support in planning, installing, operating, and managing technology for instructional and administrative functions. This section plans, designs, installs, maintains, and repairs the physical telecommunication network for voice, video, and data in schools and district/state offices.

- Supports schools in planning, designing, upgrading, and installing voice, video, and data networks in accordance with the school technology plans and/or to address specific requirements (e.g., safety/security, special student needs, etc.).
- Plans, schedules, designs, and installs the school physical network infrastructure in accordance with school technology plans, industry/building standards, and department standards and requirements.
- Maintains and repairs school physical telecommunication network for voice, video, and data.
- Supports schools in participating in programs and applying for funds for school telecommunication network installation, operation, network enhancements, and upgrades. Processes program applications on behalf of schools (e.g., E-Rate Program).
- Supports the schools in collecting and managing data needed for Standards Based Education.
- Participates in project planning (initial planning, review/revision), progress monitoring, and final inspections of telecommunication-related Capital Improvement Projects (CIP) for the schools.
- Assists schools in developing their school technology plans aligned with their Standards Implementation Design (SID).
- Supports the schools in effective use and application of standard statewide computer applications.

- Researches, reviews, analyzes, and assesses emerging telecommunications technologies and services for possible applications and practices to improve instructional and administrative functions and improve student performances. Informs and advises schools of possible use of these technologies to achieve their instructional and administrative objectives.
- Evaluates telecommunications hardware, software, and services for possible school applications.
- Participates in establishing, reviewing, and updating the department's networking policies, standards, and procedures for the installation and operation of telecommunication networks for voice, video, and data. These reviews are based on the current and emerging technologies and their potential benefit of the educational objectives and administrative needs of the schools.
- Evaluates effectiveness of the technology and telecommunication network implementation and use in the functional areas, and makes recommendations for improvements.

Voice Network Management Section

This section manages planning, installation, and operation of the voice network for the department's schools and offices.

- Provides support in planning and installing voice network infrastructure according to the school technology plan and planned administrative and instructional uses.
- Works with telecommunication service providers to secure quality and timely service at schools and offices, handles billing issues, and communicates to schools awareness of new services available to the department. Advises schools to ensure effective use of funds, credits, and reimbursements.
- Supports the schools in planning, procuring, configuring, installing, and upgrading of the voice processing systems, such as KSU, PBX, and Voice over IP systems.
- Coordinates all voice-related services and equipment installation for schools through the Telecom Request process.
- Manages repair and maintenance requests by coordinating services provided by the section and telecommunication equipment repair service providers.
- Coordinates with other state agencies in the use of the statewide voice network system and service projects and contracts.
- Installs, analyzes, and tests school and office voice network, voice system and components, determining the cause of any problem, and replaces or repairs the source of the trouble. Provides periodic preventive maintenance of voice network and equipment as needed.

Internet Services and Operations Section

This section provides Internet and Intranet services to all department users and manages planning, installing, and operating of the various Internet server hardware and software used to provide the required services.

- Manages the department's Internet/Intranet computer resources; performs system management functions of the computer servers; manages user accounts; installs, configures, and maintains services such as E-mail, Web services, Usenet news, mailing lists, domain name services, Internet chat and others.
- Provides the security of the Internet servers; works with the Network and Computer Operations Section on planning and operations of the firewalls, intrusion detection system, web content filtering servers, anti-virus system, etc. Investigates computer security break-ins and cyber misconducts committed by the department users.
- Coordinates efforts to ensure the department's web sites comply with the Americans with Disabilities Act directives and Children Internet Protection Act.
- Provides second level technical support to users in the schools and offices in troubleshooting problems and providing assistance with the Internet services offered. Provides support to the school technology personnel in the schools, who provide the first level of technical support.
- Performs system administration and maintenance functions for the Internet and Intranet servers. Applies all software upgrades and patches, manages new installation and upgrade of hardware and software.
- Evaluates, monitors, and analyzes performance of the Internet and Intranet servers and network connections/utilization for effective capacity planning and performance optimization.
- Participates in planning, designing, and implementing of the department's Internet and Intranet application plans.
- Develops training materials, conducts in-service workshops and presentations related to using the Internet as a teaching tool to improve teacher productivity and student achievement.
- Sets up Internet and Intranet client applications and services for the schools and offices. Advises users with problems determination and resolution for Internet and Intranet application systems.
- Provides support in setup and creation of web sites for the schools and offices needed to deploy Standards Based Education information.

4. OFFICE OF SCHOOL FACILITIES AND SUPPORT SERVICES

The Office of School Facilities and Support Services (OSFSS) exercises technical staff oversight of business, construction and maintenance of facilities, food services, and transportation support for the public school system. The OSFSS develops and administers administrative rules and regulations, publishes operational guidelines and provides related in-service training, monitoring and technical assistance to schools to ensure that the support is being provided in accordance with laws, policies, and accepted principles of management. The OSFSS' technical oversight of the schools' support services is exercised in

collaboration with the Complex Area Superintendent of the respective school districts.

The business branches of the OSFSS directly provide schools and state and district administrative offices with the following centralized support services: managing the statewide programs for school food services and school bus transportation services; developing, managing, and maintaining a statewide school construction program; managing the central facilities inspection and repair/maintenance programs; providing schools with consulting services in landscaping, custodial and campus security attendant programs; developing and monitoring the Neighbor Island Service Level Agreements with the Department of Accounting and General Services (DAGS); coordinating teacher and custodial personnel housing; providing training on safety, security, civil defense, hazardous materials disposition, and traffic safety; maintaining a central mail distribution system; providing a central reprographic activity; and providing energy conservation staff services.

Environmental Unit

Plans, coordinates, organizes, directs, and controls a variety of engineering and environmental services to ensure compliance with applicable environmental laws, rules, and regulations, including but not limited to the Clean Air Act, the Clean Water Act, the Endangered Species Act, the National Environmental Policy Act, the Noise Control Act, the Safe Drinking Water Act, the Resource Conservation and Recovery Act, the Toxic Substances Control Act, the Asbestos Hazardous Emergency Response Act, the Archaeological Resources Protection Act, and the National Historic Preservation Act.

- Provide technical support and make recommendations for resolving environmental issues for the Department.
- Implement and maintain a program for eliminating or minimizing the emission of air pollutants for the Department.
- Implement and maintain a program for disposing domestic and industrial wastewater for the Department.
- Implement and maintain a program for assuring the safety of drinking water for the Department.
- Implement and maintain a program for managing hazardous materials, and disposing solid and hazardous waste for the Department.
- Implement and maintain a program for protecting and enhancing indoor air quality and minimizing public exposure to indoor air pollutants for the Department.
- Implement and maintain a program for protecting endangered plant and animal species for the Department.
- Implement and maintain a program for protecting or preserving historic and archaeological sites for the Department.
- Implement and maintain a program for controlling noise emissions for the Department.
- Implement and maintain a program for preparing detailed statements assessing the environmental impacts of and alternatives to Department actions that significantly affect the environment.

- Implement and maintain a program for managing the presence of friable and non-friable asbestos containing materials at the Department's schools and other facilities.

AUXILIARY SERVICES BRANCH

Provides staff services support to the Facilities Development and Facilities Maintenance branches, develops and monitors the Neighbor Island Service Level Agreements with the DAGS, monitors the school's responsibility in meeting facilities related Energy Conservation Requirements; and provides management analyses services, including methods and procedures studies, personnel staffing requirement reviews, organizational analyses, statistical analyses, development of appropriate reorganization proposals, and management advisory services. Coordinates the distribution of the DOE mail using an array of carriers and mailing and addressing options.

Project Control Section

- Provides various staff services to the Assistant Superintendent and to the OSFSS as a whole including general management assistance; operating budget preparation and execution; program control; financial management; obtaining project funding and providing current and final project costs; tracking of projects; and processing and preparing contracts.
- Performs Control Functions. Monitors the funds expended in providing planned services to assure funds are appropriately expended; identifies deviations from authorized and/or planned expenditures. Reviews payments to contractors for services provided in accordance with contracts. Develops financial reports at periodic intervals to report progress.
- Receives and evaluates operational data and develops program policies, procedures, standards and plans.
- Participates in the development of the capital improvements program (CIP) and repair and maintenance (R&M) budget request.

School Support Program

- For the Neighbor Islands, coordinates the development of major R&M projects, including the determination of statewide budgets and priorities and monitoring the projects among schools pursuant to the Service Level Agreement.
- Prepares the budget request for water, sewer, courier service, school service and maintenance contracts and gas for the schools, prepares monthly projections on the status of the funds and processes all bill payments centrally. Annually calculates the monthly sewer rates for Oahu schools and submits the proposal to the City & County of Honolulu for negotiation and approval.
- Coordinates the school furniture and equipment program with Facilities Maintenance Branch, schools, and districts. Compiles and maintains the specifications for the school furniture pricelist.
- Compiles data and prepares budgetary documents and monitors plans and budgets of the EDN 400 R&M program for conformity.

- Coordinates and develops data and assists in drafting legislative proposals and testimonies on matters affecting the Office of School Facilities and Support Services CIP and R&M programs.

Mailroom Unit

- Provides pick up and delivery mail service to all schools and DOE offices on Oahu and to the District Offices on the outer islands to include sorting and distributing incoming/outgoing mail using an array of mail options and equipment.

School Energy Conservation Program

- Administers the DOE energy use and conservation program through analysis of school utility consumption, recommending energy saving methods and energy conservation, preparing budget energy requests, providing consultation services, etc.

Hawaii 3Rs

- Coordinates the Hawaii 3Rs program for the Department of Education.
- Assists in the coordination of the Joint Venture Education Forum (JVEF) repair and maintenance projects with schools and the military.
- Coordinates the statewide playground equipment program.

Reprographic Section

- Provides planning, budgeting, designing, preparation, printing, and distribution services to all schools and State and District Offices in the DOE. Printed items include reports, announcements, memoranda, operational forms, curriculum guides, manuals, brochures, attendance forms, posters, and other educational materials.

Printing Unit

- Provides consultative services regarding printing production format, paper stock, methods of binding, production time and estimates total production costs of all printing jobs including black/white/color copying, specifications for commercial printing, funding, distribution, etc.

FACILITIES DEVELOPMENT BRANCH

Plans, coordinates, organizes, directs and controls a variety of engineering and architectural services including land acquisition, planning, designing, project management, construction inspection, design & construction quality control, contracting, construction management, and equipping facilities and improvements for the Department of Education.

- Plans and directs the expenditure of Capital Improvement and Repair and Maintenance Funds and other operating funds released to the Department for projects.

Standards and Quality Assurance Unit

- Follows up on warranty requirements. Coordinates with and assists the Attorney General in litigation involving Department projects.

- Develops/revises design and construction guidelines based on feedback from staff and in consultation with the various industry organizations. Disseminates information and arranges for staff training where necessary.
- Assists in the development, approval, and revision of the Educational Specifications.

Planning Section

Administers and directs the planning activities of the Department's schools and other facilities. Provides land acquisition coordination and planning services; formulates and implements the Department's CIP and R&M budget requests; reviews office space needs and conducts other studies as directed.

The branch is organized into the Building Inspection Planning Unit, Planning Unit I and Planning Unit II.

Building Inspection Planning Unit

- Provides technical support to identify, cost, plan and evaluate repair projects and make recommendation on the condition of department facilities.
- Provide staff assistance in project tracking activities to prioritize, schedule, budget and monitor construction and subsequent warranty period for major R&M projects.

Planning Unit I

- Maintains annual records on use of classrooms. Prepares and disseminates Classroom Utilization Report. Determines classroom requirements and estimates future classroom needs.
- Reviews, proposes amendments and interprets administrative rule, Chapter 8-39, Use of School Buildings, Facilities and Grounds.
- Conducts studies for the development of new schools including data gathering for present and projected enrollments and geographic exemptions.
- Coordinates the preparation of complex development plans with schools and districts.
- Assists in determining the feasibility of school service boundary changes, school grade reorganizations; alternative means to accommodate overcrowded schools, and the need for new schools.
- Prepares school capacity deficit summaries by districts for the six-year planning period.
- Prepares draft budgets, executive budget requests, legislative submittals/testimonies, expenditure plans, coordinates with school complexes and districts, and finalizes the state budget draft for approval.
- Provides training, workshops, or briefings for school administrators and personnel, school organizations, public, legislators, and community members on planning and financing schools and offices, including the CIP budgeting and expenditure cycles, relationship of housing developments, or understanding of legislative appropriations.

Planning Unit II

- Prepares cost estimates and schedules for land, plans, design, construction and equipment for proposed projects. This includes analysis and ranking of alternatives by cost effectiveness, risk, and other factors for meeting program space needs and schedules.
- Prepares site selection studies and assists in making presentations to interested groups. Coordinates the actual acquisition of the site, including securing subdivision or consolidation approvals, state land use boundary change and/or county general plan and zoning changes. Prepares tenant relocation plans, coordinates the relocation of all tenants from the site, and disburses the appropriate compensation.
- Prepares complex development reports when a number of buildings are to be built on a site and project development reports (as required) for the individual buildings.
- Processes project initiations, makes environmental assessments, provides scope of work, prepares engineering estimates of the project cost and schedule, and as applicable, preparing an analysis of alternatives for providing the program spaces required. Prepares and files environmental notices for each project as necessary.
- Coordinates the development of future school sites and existing school properties.
- Processes requests for review of environmental impact statements and environmental assessments for change of State zoning and county zoning and county zoning classifications, subdivision requests, and other county and State requests related to housing developments.
- Coordinates and organizes responses to developer requests related to future school sites, including fair share contributions, State Land Use Commission submittals, and county zoning applications.
- Researches, analyzes, prepares responses or possible solutions to requests for easements, revocable permits, long-term leases, executive orders, return of surplus lands, exchange or purchase of land for schools, encroachments or other problems related to school sites or department office locations.

Project Management Section

Provides in-house and consultant design services for new facilities and repairs or alterations of existing facilities. Generally, the Project Management Unit I performs in-house design of engineering projects and project management services; Project Management Unit II provides project management services; and Project Management Unit III conducts in-house architectural design of projects and project management services.

Construction Management Section

Provides construction inspection; administers construction management services and contracts for construction of facilities and acquisition of furniture and equipment for such improvements; and provides services to scope work, formulate requirements, solicit bids and monitor construction activity for major R&M projects initiated by purchase order.

FACILITIES MAINTENANCE BRANCH

Plans, coordinates, organizes, directs and controls a variety of services, which include maintaining and repairing public school buildings and facilities; providing technical support to school HVAC systems and electrical systems; and providing the overall planning and managing of repair and maintenance support to school facilities.

Develops and administers policies, rules, regulations, and department budgets for the school custodial, school landscaping and grounds maintenance programs.

Repair and Maintenance Engineering Section

Provides engineering and technical support to maintain school facilities.

Develops technical specifications, estimates and administers maintenance service contracts for repair and maintenance functions, including but not limited to air conditioning, elevator maintenance contracts, refuse pickup, program bells, grease trap and fire extinguishers.

Repair and Maintenance Operations Section

Supports planning and implements an on-going and comprehensive program of repair and preventative maintenance of assigned facilities.

Windward Oahu, Honolulu, Central Oahu and Leeward Oahu Units

- Provides for the overall management of repair and maintenance of school buildings and facilities; coordinates these functions with school personnel; develops a program of preventative maintenance for school buildings and facilities; and administers a variety of repair and maintenance contracts for school buildings.
- Operates a centralized lawn mowing service for all Oahu public schools.

Carpentry and Building Maintenance Subunit--Carpentry Group/Building Maintenance Group/Roofing & Maintenance Services

- Provides carpentry, painting, and building maintenance services in the repair, maintenance, and emergency repairs of assigned school buildings.
- Develops a program for regular and preventative maintenance of school buildings and other facilities.
- Administers contracts for a variety of repair and maintenance functions.
- Constructs "finished" wood products such as doors, cabinets, and shelving.
- Performs minor roofing repairs, inspection, and maintenance work by clearing gutters and downspouts.
- Provides utility/auxiliary services: Moving, disposal, etc.

Electrical and Plumbing Subunit--Electrical Group/Plumbing Group

- Provides electrical and plumbing services in the repair, maintenance, and emergency repairs of assigned school buildings.
- Develops a program for regular and preventative maintenance for school buildings and other facilities.
- Administers contracts for a variety of repair and maintenance functions.

Support District Unit

Provides for those repair and maintenance services that are not regularly utilized or which are so specialized that their operations would be more efficient if they were centralized and assigned out to the other districts as needed.

General Construction and Maintenance Group I

- Provides general construction services to maintain school facilities in good condition.

Masonry Services

- Provides masonry support for school facilities.

Construction and Maintenance Services

- Provides transport support by delivering materials and supplies as well as transporting new and used school furniture and equipment.

Automotive Service and Repair Groups I and II

- Provides for the control and disposition of all equipment and vehicles in the branch; provides for the repair and maintenance of these equipment and vehicles; and provides for equipment operators.

General Construction and Maintenance Group II

- Provides general construction and transport services to maintain school facilities in good condition.

Welding and Furniture Repair Services

- Provides support in metal repair work and fabrication to school facilities and structures, and maintains, repairs, and refurbishes a variety of furniture to meet school needs and to preserve the school furniture and equipment inventory.

General Labor Services

- Provides physical labor to support activities such as erecting fencing, delivery/pickup of school furniture, and installing sign posts.

School Custodial Services Program

- Provides training, workshops, and consultative services on school maintenance, custodial scheduling, and custodial practices.
- Develops supply and equipment standards, evaluates new products and recommends purchases for custodial or ground maintenance products for schools.

- Provides emergency response support as needed.

School Landscaping Services Program

- Operates a centralized lawn mowing service for all Kauai, Maui and Hawaii islands.
- Provides landscaping plan assistance, drainage assessment and mitigation planning, school grounds maintenance technical assistance and training and school beautification consultations for all schools.

Purchasing Services Office

- Provides for the centralized purchasing and storing of equipment and supplies for the branch.
- Provides for the storing, warehousing, and inventorying of materials, supplies and equipment.
- Provides for centralized school furniture purchasing, storing, and distributing.
- Provides administrative and technical support for state-sponsored events and activities.

SCHOOL FOOD SERVICES BRANCH

The School Food Services Branch develops and administers statewide program plans, budgets, policies, standards and specifications for food services operations of the public school system.

Fiscal Management

- Prepares budgets, expenditure plans, and financial projects for the School Food Services Program.
- Provides technical assistance to the Assistant Superintendent in developing and administering fiscal policies and internal control procedures governing program expenditures, cafeteria cash collections and meal tickets, delivery/receipt/inventory of cafeteria supplies and equipment, and other fiscal transactions of the program.
- Reviews and analyzes financial data of departmental ledgers and prepares financial reports to management for decision-making and evaluation.
- Participates in the United States Department of Agriculture (USDA) disaster relief program for the DOE.
- Coordinates the administration of the USDA Verification of Free and Reduced Price Applications; On-Site Reviews and Coordinated Review Efforts.
- Meets with independent auditors to discuss findings and recommendations of School Food Services Program audits.

Technical Support

- Reviews, analyzes, and develops intermediate and long-range program plans for improvement of the School Food Services Program.

- Develops and administers the DOE School Food Services Program policies, rules, regulations, standards, and specifications governing the operations of public school cafeterias.
- Promotes participation in various child nutrition programs throughout the State by disseminating information and publications, and in-servicing Complex Area Superintendent's staff, school staff and school food service managers.
- Researches, tests, and evaluates new products (food, supplies, equipment, and services) and prepares bid specifications, and promotes the introduction of new products in the statewide public school system.
- Coordinates the planning of new cafeteria kitchens, and the renovation and replacement of existing cafeteria equipment.
- Maintains liaison with other DOE state offices and State agencies on matters of mutual concern.
- Consolidates reports from schools for reimbursement claims, staffing, and purchasing information.
- Inspects food service operations of the DOE public schools for compliance with applicable federal, state, and county laws and administrative regulations and DOE program policies, standards, and specifications.
- Provides technical assistance and consultation to school principals, food service managers, and workers on improving their operations, including, but not limited to, efficient and effective utilization of facilities, equipment, supplies, and personnel; improved food preparation, handling and storage procedures and practices; reliable recordkeeping; accounting and reporting; dissemination of program information; and maintaining liaison with appropriate local field offices of other state agencies and the county governments.

Commodity Distribution

- Reviews the DOE menu requirements and requests commodity foods from the Office of Hawaii Child Nutrition Program (OHCNP).
- Consults with the OHCNP on food safety notification, and other USDA Commodity Distribution concerns.
- Allocates and distributes federal commodities to public schools in the most cost-efficient manner.
- Reviews use of commodities by recipient schools.
- Maintains records and prepares reports on commodity inventory and receipts.
- Administers the Department of Defense fresh fruits and vegetable commodity purchasing program for the DOE schools.

SCHOOL SAFETY AND EMERGENCY PREPAREDNESS BRANCH

Develops and administers policies, rules, regulations, and department budgets for the safety and security and school inspection programs to include analyzing patterns of work-related injuries in order to more effectively train and maintain a safe and healthful environment.

- Administers the safety and security program for the public school system; plans and administers a statewide program to improve school safety, security, as well as emergency preparedness.
- Under the direction of the Deputy Superintendent, administers the department's involvement with the State Civil Defense Program. Communicates with State Civil Defense and County Civil Defense in times of emergencies or natural disasters. Coordinates the designation of school facilities as evacuation shelters with State Civil Defense.
- Coordinates the traffic safety program for the public school system; maintains liaison with the county police departments and other agencies regarding traffic safety, including the Junior Police Officers (JPO) program. Serves on the Oahu Traffic Safety Committee to resolve school-related safety concerns.
- Administers the Federal Asbestos Hazard Emergency Response Act (AHERA) for the control, abatement, management, inspection and training.
- Administers and coordinates night security program for selected schools.
- Administers and coordinates the surveillance camera program. Provides guidance in the use of surveillance cameras. Maintains school justification for surveillance camera checklists.
- Coordinates other activities aimed at preventing, managing, and reducing offenses against persons, property, and the living-learning environment of schools; and accidents, injuries and losses to students, staff, or other users of school facilities.
- Coordinates and represents the department in developing helicopter landing guidelines and approving appropriate sites.
- Chairs the department's Statewide Safety Committee meetings. Prepares the monthly agenda, disseminates meeting minutes. Administers and coordinates the implementation of school safety committees.
- Administers the department's hazardous materials management program, including training, recordkeeping, and mitigation or disposal; coordinates and administers Hawaii Occupational Safety and Health (HIOSH) hazard communication standards and program; and maintains liaison with the Department of Labor and other appropriate agencies regarding HIOSH regulations.
- Coordinates responses to Hawaii Occupational Safety and Health (HIOSH) issues and concerns.
- Coordinates responses to issues and concerns regarding radon, safe drinking water, lead in paint, indoor air quality and electrical and magnetic fields issues and concerns.
- Coordinates the School Safety manager program with the contractor and school administrators; attends to operational matters of the program.
- Administers the school emergency preparedness program. Provides training and technical assistance to schools in the development of school emergency responses, including lock downs, shelter in place, and emergency evacuations. Provides bomb threat response training and technical assistance to schools; compiles and analyzes bomb threat information.

- Administers and implements the Department's picture identification badge program; provides ID production services for all school level administrators, schools on military bases, and all district and state employees; maintains employee ID database of all IDs issued.
- Manages and coordinates the school fire inspection program. Acts as liaison to State Fire Council and County Fire Departments. Represents the Department in all fire inspection related matters including fire code violations and fire safety concerns.
- Coordinates the School Inspection Program with schools; works with the Facilities Development Branch, Facilities Maintenance Branch, and the Neighbor Island Department of Accounting and General Services to address concerns raised by the school inspections.

STUDENT TRANSPORTATION SERVICES BRANCH

The Student Transportation Services Branch is responsible for the statewide program planning, budgeting, implementing, enforcing and evaluating of student transportation services for eligible public school students in accordance with Section 302-406, Hawaii Revised Statutes. The program provides safe, timely, and efficient student transportation services to eligible students to attend and participate in schools, designated programs, and other services statewide.

- Develops and administers contracts that procure the required services from privately-operated school bus contractors to transport eligible public school students to and from public school and as required by a student's Individualized Education Program (IEP) or Modification Plan (MP).
- Develops, prepares, and issues guidelines and procedures related to student transportation requirements to ensure the proper processing of necessary paperwork to ensure services are provided on a timely basis.
- Identifies training needs of its constituency and develops and prepares appropriate training modules.
- Provides information on federal, state, and contract requirements to schools, parents, media, and other interested parties.
- Serves as the Department's primary point of contact/liaison for student transportation concerns.
- Reviews, processes, and maintains applicable DOE employment forms for school bus contractors' personnel.
- Conducts annual criminal history check for school bus drivers and aides.
- Prepares and provides written and oral testimonies/reports to legislative bills and resolutions.
- Prepares and provides written and oral testimonies/reports to the Board of Education and its committees, as necessary.
- Prepares and provides written responses to inquiries addressed to the Superintendent and/or other state officials.
- Reviews, approves, audits, procures, and distributes monthly Oahu Transit Services bus passes for eligible Honolulu District students who do not have access to contracted bus services.

- Assists in the determination of student eligibility for services being requested.
- Coordinates special education student transportation requests received from school administrators.
- Represents the Department at school bus contractors' and other meetings as necessary.
- Develops, prints, distributes, and maintains student transportation forms to meet federal, state, municipal, and Departmental transportation requirements.
- Prepares budget requests and other related budget documents and properly performs all budget functions.
- Provides oversight relating to the collection of student bus fares and seeks accountability for the collections.
- Ensures the proper and prompt payment of program claims.
- Audits deposits into special funds and disburses available funds as required to meet contractual obligations.
- Collects and maintains statistics related to contracted student transportation services for evaluation purposes.
- Operates school buses to address student transportation for the Kona area.

5. STANDARD PRACTICES

Provides centralized resources to serve and support the Department of Education offices and programs relating to preparing and implementing policies, procedures, and regulations. Provides positive and helpful information with regard to procedures to be followed in the development and implementation of policies and procedures including but not limited to DOE School Code, Handbook, Chapter 91, H.R.S., operating procedures, etc.